



CATALOG

Thermal

Circuit Protection



Carling Technologies®
/// NOW PART OF



Littelfuse®

FOUNDED IN 1920



Since its founding, Carling Technologies has continually forged a tradition of leadership in quality and product innovation.

There are few products that Carling Technologies hasn't turned "ON" and fewer industries that haven't turned to Carling for solutions.

With ISO and TS registered manufacturing facilities and technical sales offices worldwide, Carling ranks among the world's largest manufacturers of circuit breakers, switches, power distribution units, digital switching systems and electronic controls.



SWITCHES & CONTROLS

- Electronic
- Rotary
- Rocker
- Combination
- Toggle
- Battery
- Pushbutton
- Disconnect

CIRCUIT PROTECTION

- Hydraulic-Magnetic
- Thermal
- GFCI / ELCI
- Fuse Links & Holders

CUSTOM SOLUTIONS

- PDU's
- Keypads
- Control Modules

MULTIPLEXED POWER SYSTEMS

- HMI Devices & I/O Modules
- Programmable Displays
- Data Communication Interfaces
- Electrical Systems Monitoring

STRATEGIC MARKETS SERVED:



On/Off Highway



Marine



Telecom/Datacom



Renewable Energy

HEADQUARTERS/MANUFACTURING FACILITIES:



OTHER SERVED INDUSTRIES:



Medical



Industrial Control



Audio / Visual



Commercial Food



HVAC



Floor Care



Generators



Small Appliances



Security Systems



Test & Measurement

COMPETITIVE ADVANTAGES⁺



Innovative & Eco-Friendly Products



Excellent Quality & Customer Service



Reliable & On-Time Delivery



Vertical Integration

WORLDWIDE NUMBERS:



2800⁺
EMPLOYEES



150⁺
ENGINEERS



70⁺
DISTRIBUTORS



50⁺
REP FIRMS

Table of Content

Selector Guide	5
C1005B-SERIES	6
CLB-SERIES	8
CMB-SERIES	12
CTB-SERIES	16

HELPFUL TIP

Click on a product to go directly to that page number!

Thermal Circuit Protectors

This catalog features Carling Technologies' current line of thermal circuit protectors, from 3 to 60 amps, which offer reliable, cost effective circuit protection. Thermal circuit protectors utilize a bimetallic strip electrically in series with the circuit. The heat generated by the current during an overload deforms the bimetallic strip and trips the breaker. Thermal protectors have a significant advantage over fuses in that they can be reset after tripping. They can also be used as the main ON/OFF switch for the equipment being protected.

Typical Applications Include:

- Household Appliances
- Transportation
- Marine
- Power Strips
- Medical Equipment
- Audio Visual Equipment
- Power Supplies
- Exercise Equipment

Available Online are tools such as a [configurit](#), [product selector](#) and [stock check](#). Please visit www.carlingtech.com for the latest information on all our products.

Application Solution Engineers are readily available to assist you in selecting the appropriate product for your application. For further assistance, please email us at team2@carlingtech.com

Custom Design Solutions can be tailor-made for most any application using our extensive engineering resources.

Other Products such as hydraulic-magnetic and ground fault circuit breakers, switches and miniature switches are also

© 2020 Carling Technologies, Inc.

Carling Technologies is a registered trademark of Carling Technologies, Inc. in the U.S. and other countries.

Selector Guide



CTB-Series



CMB-Series



CLB-Series



C1005B-Series

Poles	1	1	1	1
Actuator Style	rocker	pushbutton	pushbutton	rocker, lighted rocker
Max Current & Voltage Ratings	3 to 16A, 125-250VAC, 50VDC	3 to 20A, 125-250VAC, 32 VDC	3 to 60A, 125-250VAC, 32 VDC	7 to 16A, 125-250VAC, 32VDC
Max Interrupting Capacity	1000A	2500A@32VDC	2500A@32VDC	1000A
Available Circuits	series trip manual reset	series trip manual reset	series trip manual reset	series trip manual reset
Termination	.250" tab	.250" tab, .250" tab with 90° bend, screw terminal, screw terminal with 90° bend	.250" tab, .250" tab with 90° bend, screw terminal, screw terminal with 90° bend	.250" tab, solder lug
Mounting Method	front panel snap-in	threaded bushing, front panel snap-in	threaded bushing, front panel snap-in	front panel snap-in
Operating Temperature	-10°C to 60°C	-10°C to 60°C	-10°C to 60°C	-10°C to 65°C
Agency Approvals	UL, cUL, VDE, CE	UL, cUL, TUV, CE, ISO 8846 for ignition protection / marine	UL, cUL, TUV, CE, ISO 8846 for ignition protection / marine	UL, cUL, TUV

C1005B-Series

Thermal Circuit Breaker

PRODUCT WEBPAGE

request sample, configure part



The C1005B-Series offers the functionality of a switch and circuit breaker in a single compact package, which fits an industry standard .550 x 1.125 mounting hole. This combo device eliminates the need for both a switch and thermal circuit protector on customer panels. By using only this multi-purpose product, wiring and assembly costs are greatly reduced, while at the same time, valuable panel real estate is saved.

1	7-16	125-250	32
Pole	Amps	VAC Max	VDC Max

Typical Applications

- Household Appliances
- Marine
- Medical Equipment
- Exercise Equipment
- On/Off-Highway
- Power Strips and Supplies
- Audio Visual Equipment
- ROHS Compliant

Ordering Scheme

Sample Part Number **C1005B - 3 B 15 1 B R 3**

Selection 1 2 3 4 5 6 7 8

1. SERIES

C1005B

2. ILLUMINATION

2 Non-Lighted **3** Lighted

3. TERMINATION

A Solder Lug **B** .250 Tab

4. CURRENT RATING (AMPERES)

07 7 amps	11 11 amps	15 15 amps
08 8 amps	12 12 amps	16 16 amps
09 9 amps	13 13 amps	
10 10 amps	14 14 amps	

5. CONTACT MATERIAL ¹

1 Silver Cad Oxide (switch), Silver plated copper (breaker)

6. BEZEL LEGEND IMPRINT

B Black Bezel with white legend
W White Bezel with black legend
C Gray Bezel with black legend

7. ROCKER COLOR

R Red
G Green
U Blue
T Clear

Note: RESET OFF Legend is standard.

8 LAMP VOLTAGE

3 Neon Lamp 125/250 VAC **9** Non-lighted

Notes:

1. Silver cad oxide switch and breaker contacts are available as a special order. Specify 3 for selection 5

[Configure Complete Part Number >](#)

[Browse Standard Parts >](#)

Dimensional Specs

inches [millimeters]

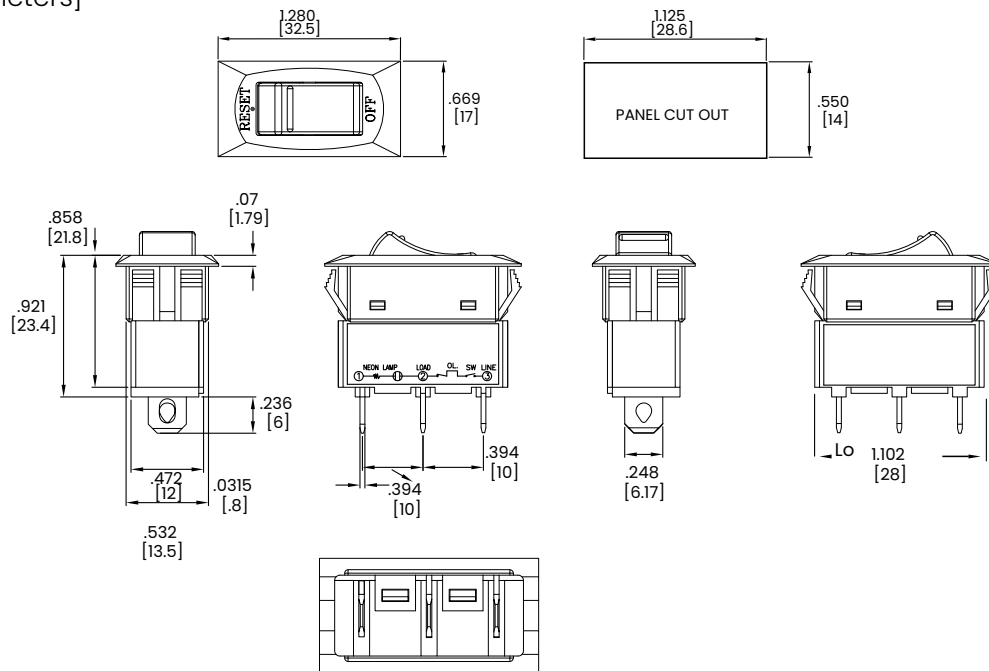

Time Delay

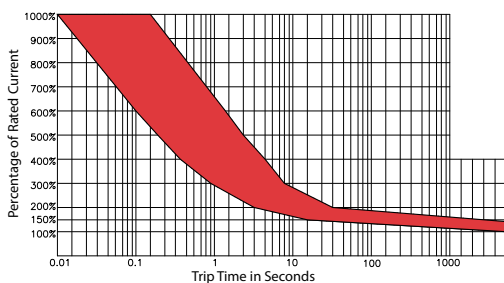

Overload	Trip Time
100%	No Trip
135%	Trip in 1 hr
200%	4.0 ~ 40 sec.
300%	0.9 ~ 8.0 sec.
400%	0.42 ~ 5.0 sec.
500%	0.25 ~ 3.0 sec.
600%	0.01 ~ 1.8 sec.

Trip Time Factor ¹	
-10 °C x 1.70	30 °C x 0.90
-5 °C x 1.60	35 °C x 0.85
0 °C x 1.50	40 °C x 0.80
5 °C x 1.40	45 °C x 0.75
10 °C x 1.30	50 °C x 0.70
15 °C x 1.20	55 °C x 0.65
20 °C x 1.10	60 °C x 0.60
25 °C x 1.00	

Notes:

1. Trip Time factor is a guideline that indicates ambient temperature effect on trip times at various overload values.

CLB-Series

Thermal Circuit Breaker

[PRODUCT WEBPAGE](#)

request sample, configure part

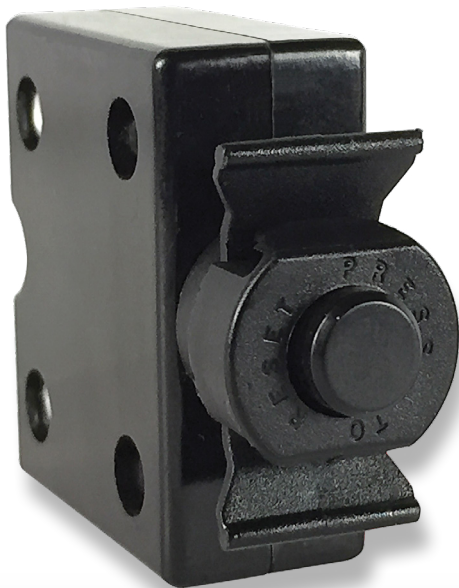
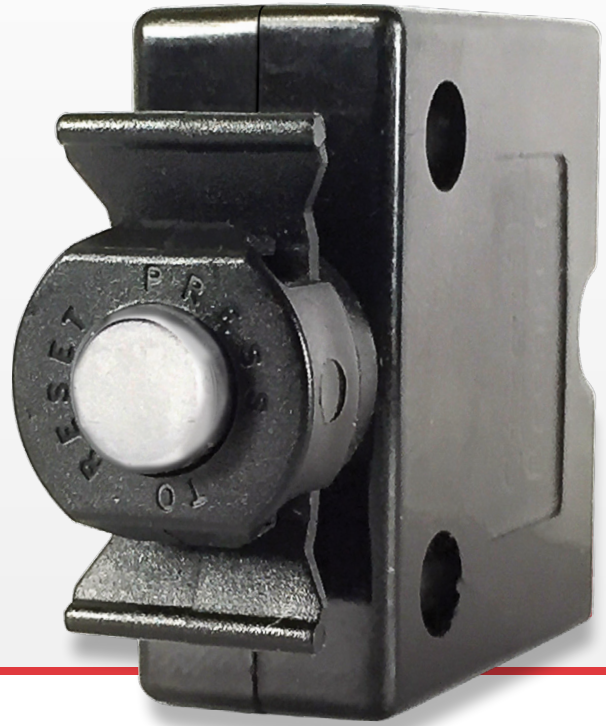

The CLB-Series is a compact, single pole, push-to-reset family of thermal circuit breakers designed to protect equipment. Utilizing simple, precision design with few moving parts, these breakers offer cost effective, extremely reliable circuit protection with high resistance against shock and vibration.

1	3-60	125-250	32
Pole	Amps	VAC Max	VDC Max

Typical Applications

- Household Appliances
- Marine
- Medical Equipment
- Exercise Equipment
- On/Off-Highway
- Power Strips and Supplies
- Audio Visual Equipment
- ROHS Compliant

Ordering Scheme

Sample Part Number **CLB - 10 3 - 12 C 3 N - B - A / 10**

Selection 1 2 3 4 5 6 7 8 9 10

1. SERIES

CLB

2. RATING

03	3 amps	10	10 amps	25	25 amps
04	4 amps	12	12 amps	30	30 amps
05	5 amps	13	13 amps	35	35 amps
06	6 amps	15	15 amps	40	40 amps
07	7 amps	18	18 amps	50	50 amps ¹²
08	8 amps	20	20 amps	60	60 amps ¹²

3. VOLTAGE

3 125-250VAC / 32 VDC

4. MOUNTING HOLE ⁹ see next page for diagram

11	M11 ¹
12	M12 ²
00	Snap In Style ³
27	3/8" 27 UNS ⁴

5. BUSHING ⁹ see next page for diagram

METAL		PLASTIC	
A	Type A ⁶	C	Type C ⁵
B	Type B ¹⁶	D	Type D ⁷
J	Type J ⁸	E	Type E ⁸

6. MOUNTING NUT ⁹ see next page for diagram

N	None	5	Type 5
1	Type 1	6	Type 6 ^{4,14}
2	Type 2	7	Type 7 ⁴
3	Type 3 ¹⁷	8	Type 8 ⁴
4	Type 4		

7. INDICATOR PLATE ⁹ see next page for diagram

N	None	B	Silver Printing on Black
A	Embossed Legend		

8. BUTTON

B	Black	R	Red	W	White
---	-------	---	-----	---	-------

9. TERMINAL ^{10,11,15} see next page for diagram

A	Type A	E	Type E	J	Type J
B	Type B	F	Type F	K	Type K
C	Type C	G	Type G	R	Type R
D	Type D	H	Type H		

10. BUTTON MARKING (IF BLANK, NO MARKING) ¹³

Button Marking Orientation:

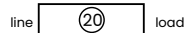

03	3 amp	10	10 amp	25	25 amp
04	4 amp	12	12 amp	30	30 amp
05	5 amp	13	13 amp	35	35 amp
06	6 amp	15	15 amp	40	40 amp
07	7 amp	18	18 amp	50	50 amp
08	8 amp	20	20 amp	60	60 amp

Notes: Tolerance ±.005 [127] unless otherwise specified.

- 1 Used with bushing A or B only.
- 2 Used with bushing A or C only.
- 3 Used with bushing D only.
- 4 Used with bushing E & J only.
- 5 Used with M12 mounting hole only.
- 6 Used with M11 and M12 mounting hole only.
- 7 Used with mounting hole 00 only.
- 8 Used with 27 mounting hole only.
- 9 All hardware available separately.
- 10 Greater than 35 amp rating must use solder joint to connect wire to non-screw type terminals.
- 11 Terminals are .040 [1.0] thickness for ratings greater than 35 amps. Terminals are .315 [0.8] thickness is for ratings less than 35 amps.
- 12 Available only with 10-24 unc. screw terms. (select type F, G, H, J only.) UL, CUL only.
- 13 Amp rating must match button marking (ex: "20" will be marked on the button of the breaker) Thickness is 3.0 mm, .118 in.
- 14 Thickness is 3.0 mm, .118 in.
- 15 Screw terminals are 8-32 UNC.
- 16 Used with M11 mounting hole only.
- 17 Includes molded in "PRESS TO RESET" marking.

[Configure Complete Part Number >](#)



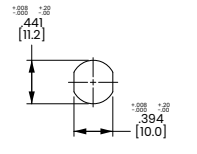
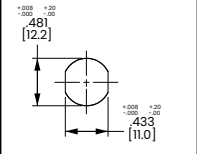
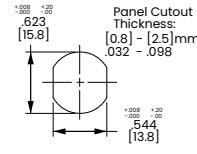
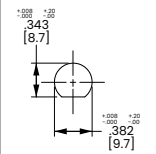

[Browse Standard Parts >](#)

Ordering Scheme Diagrams

4. MOUNTING HOLE

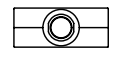
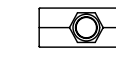
 <p>11</p>	 <p>12</p>	 <p>Panel Cutout Thickness: [0.8] - [2.5]mm 0.032 - 0.098</p> <p>00</p>	 <p>27</p>
---	---	--	---

5. BUSHING

METAL			PLASTIC		
 <p>TYPE A</p>	 <p>TYPE B</p>	 <p>TYPE J</p>	 <p>TYPE C</p>	 <p>TYPE D</p>	 <p>TYPE E</p>

6. MOUNTING NUT

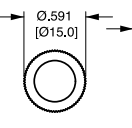
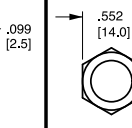
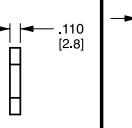
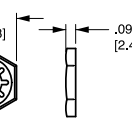
METAL	METAL PAL	PLASTIC	HEX BOOT
 <p>TYPE 1</p>	 <p>TYPE 2 / TYPE 6</p>	 <p>TYPE 3</p>	 <p>TYPE 5 / TYPE 8</p>

Type 5 is clear hex boot. Type 8 is black hex boot (available for bushings G, J & K only); Type 3 nut includes molded in "PRESS TO RESET" marking.

7. INDICATOR PLATE

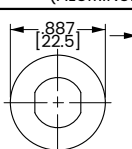
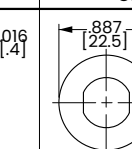
Embossed (ALUMINUM)	Silver Printing On Black
 <p>887 [22.5] .016 [.4]</p>	 <p>887 [22.5] .016 [.4]</p>

All indicator plates are marked "Suppl. Prot. press to reset".

9. TERMINAL

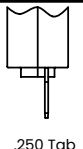
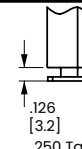
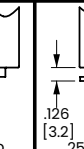
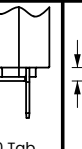
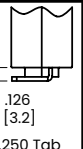
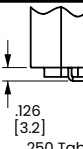
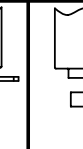
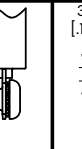
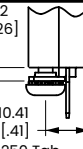
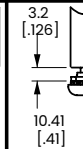
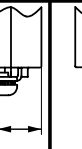
 <p>TYPE A : Straight</p>	 <p>TYPE B : Line Pin</p>	 <p>TYPE C : Load Pin</p>	 <p>TYPE D : 90° Bend</p>	 <p>TYPE E : 90° Bend Backward</p>	 <p>TYPE F : Screw Terminal</p>	 <p>TYPE G : Mixed Terminals 90° Bend Line</p>	 <p>TYPE H : Screw Terminal 90° Bend</p>	 <p>TYPE J : Screw Terminal 90° Bend</p>	 <p>TYPE R : Screw Terminal without</p>	 <p>TYPE K : Mixed Terminals 90° Bend Load</p>
--	--	--	--	---	--	---	---	---	---	---

Dimensional Specs

inches [millimeters]

3-40A Construction

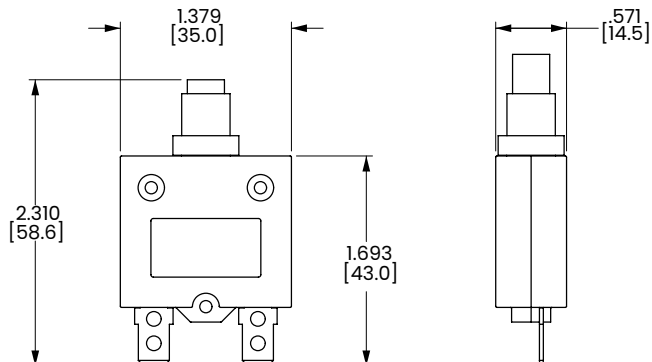

50 & 60A Construction

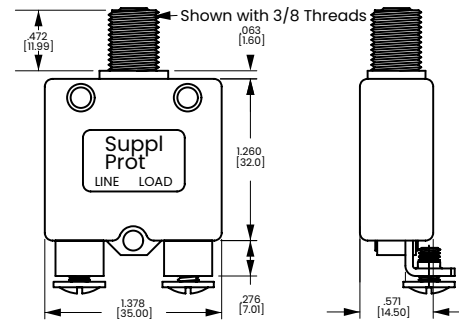

Time Delay

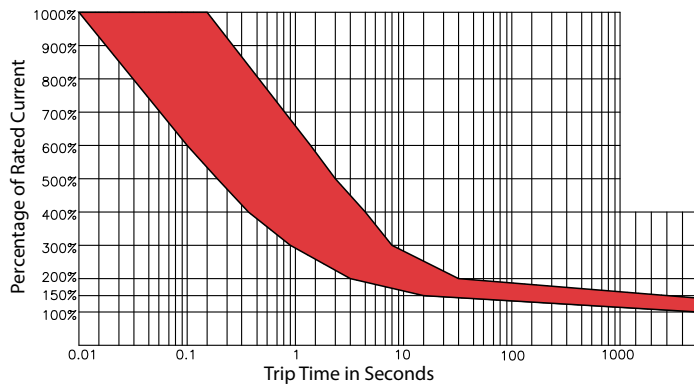

Overload	Trip Time
100%	No Trip
135%	Trip in 1 hr
200%	4.0 ~ 40 sec.
300%	0.9 ~ 8.0 sec.
400%	0.42 ~ 5.0 sec.
500%	0.25 ~ 3.0 sec.
600%	0.01 ~ 1.8 sec.

Trip Time Factor ¹	
-10 °C	x 1.70
-5 °C	x 1.60
0 °C	x 1.50
5 °C	x 1.40
10 °C	x 1.30
15 °C	x 1.20
20 °C	x 1.10
25 °C	x 1.00
30 °C	x 0.90
35 °C	x 0.85
40 °C	x 0.80
45 °C	x 0.75
50 °C	x 0.70
55 °C	x 0.65
60 °C	x 0.60

Notes:
1. Trip Time factor is a guideline that indicates ambient temperature effect on trip times at various overload values.

CMB-Series

Thermal Circuit Breaker

PRODUCT WEBPAGE

request sample, configure part



The CMB-Series is a compact, single pole, push-to-reset family of thermal circuit breakers designed to protect equipment. Utilizing simple, precision design with few moving parts, these breakers offer cost effective, extremely reliable circuit protection with high resistance against shock and vibration.

1	3-20	125-250	32
Pole	Amps	VAC Max	VDC Max

Typical Applications

- Household Appliances
- Marine
- Medical Equipment
- Exercise Equipment
- On/Off-Highway
- Power Strips and Supplies
- Audio Visual Equipment
- ROHS Compliant

Ordering Scheme

Sample Part Number **CMB - 10 3 - 11 C 3 N - B - A / 10**

Selection 1 2 3 4 5 6 7 8 9 10

1. SERIES

CMB

2. RATING

03 3 amps	08 8 amps	15 15 amps
04 4 amps	10 10 amps	16 16 amps
05 5 amps	12 12 amps	20 20 amps
06 6 amps	13 13 amps	
07 7 amps	14 14 amps	

3. VOLTAGE

3 125-250VAC / 32 VDC

4. MOUNTING HOLE ^{see next page for diagram}

11 M11 ¹
12 M12 ²
00 Snap In Style ³
27 3/8" 27 UNS ¹⁵
28 3/8" 27 UNS (double flattened) ¹²

5. BUSHING ^{see next page for diagram}

PLASTIC		METAL	
C Type C ⁴		J Type J ⁸	
D Type D ⁴			
E Type E ⁵			
G Type G ⁸			
H Type H ⁶			
K Type K ¹³			

6. MOUNTING NUT ^{7 see next page for diagram}

N None	5 Type 5
1 Type 1	6 Type 6 ¹⁴
2 Type 2	7 Type 7 ⁹
3 Type 3 ¹¹	8 Type 8 ⁹
4 Type 4	

7. INDICATOR PLATE ^{9 see next page for diagram}

N None	B Silver Printing on Black
A Embossed Legend	

8. BUTTON

B Black	R Red	W White
----------------	--------------	----------------

9. TERMINAL ^{10,11,15 see next page for diagram}

A Type A	E Type E	J Type J
B Type B	F Type F	K Type K
C Type C	G Type G	R Type R
D Type D	H Type H	

10. BUTTON MARKING (IF BLANK, NO MARKING) ¹³

Button Marking Orientation:

line  load

03 3 amp	08 8 amp	15 15 amp
04 4 amp	10 10 amp	16 16 amp
05 5 amp	12 12 amp	20 20 amp
06 6 amp	13 13 amp	
07 7 amp	14 14 amp	

Notes: Tolerance ±.005 [.127] unless otherwise specified.

- 1 Used with bushing C or D only.
- 2 Used with H bushing only.
- 3 Used with bushing E only.
- 4 Used with M11 mounting hole only.
- 5 Used with mounting hole 00 only.
- 6 Used with M12 mounting hole only.
- 7 All hardware available separately. Consult factory.
- 8 Available with mounting hole 27 only.
- 9 Available with G, J or K bushing only.
- 10 Amp rating must match button marking (ex: 20 will be marked on the button of CMB-203-27G3N-W-A/20)
- 11 Includes molded in "PRESS TO RESET" marking.
- 12 Available with K bushing only.
- 13 Available with mounting hole 28 only.
- 14 Thickness is 3.0 mm, .118 in.
- 15 Available with G or J bushing only.

[Configure Complete Part Number >](#)





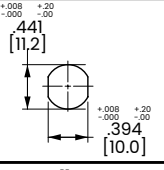
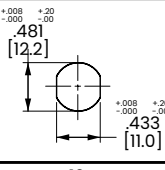
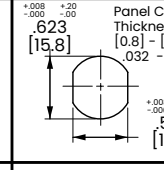
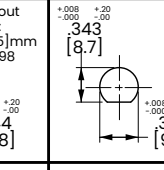
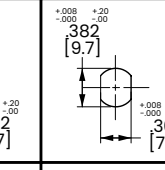

[Browse Standard Parts >](#)

Ordering Scheme Diagrams

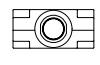
4. MOUNTING HOLE

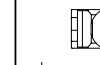
 <p>.441 [11.2]</p> <p>.394 [10.0]</p>	 <p>.481 [12.2]</p> <p>.433 [11.0]</p>	 <p>.623 [15.8]</p> <p>.544 [13.8]</p> <p>Panel Cutout Thickness: [0.8] - [2.5]mm .032 - .098</p>	 <p>.343 [8.7]</p> <p>.382 [9.7]</p>	 <p>.382 [9.7]</p> <p>.302 [7.7]</p>
11	12	00	27	28

5. BUSHING

PLASTIC						METAL
						
.067 [1.7]	.067 [1.7]	.118 [3.0]	.067 [1.7]	.067 [1.7]	.067 [1.7]	.067 [1.7]
.382 [9.7]	.382 [9.7]	.382 [9.7]	.319 [8.1]	.472 [12.0]	.472 [12.0]	.472 [12.0]
TYPE C	TYPE D	TYPE E	TYPE H	TYPE G	TYPE K	TYPE J

6. MOUNTING NUT

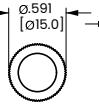
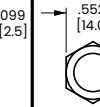
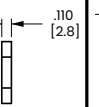
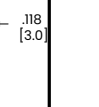
METAL	METAL PAL	PLASTIC	HEX BOOT
			
0.591 [15.0]	.552 [14.0]	0.741 [18.8]	0.591 [15.0]
.099 [2.5]	.110 [2.8]	.118 [3.0]	.118 [3.0]
TYPE 1	TYPE 2/ TYPE 6	TYPE 3	TYPE 5/TYPE 8

Type 5 is clear hex boot. Type 8 is black hex boot (available for bushings G, J & K only); Type 3 nut includes molded in "PRESS TO RESET" marking.

7. INDICATOR PLATE

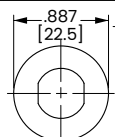
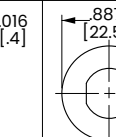
Embossed (ALUMINUM)	Silver Printing On Black
	
.887 [22.5]	.887 [22.5]
.016 [.4]	.016 [.4]

All indicator plates are marked "Suppl. Prot. press to reset".

9. TERMINAL

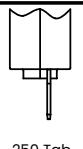
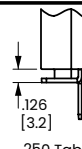
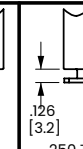
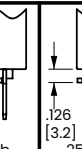
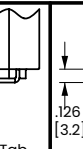
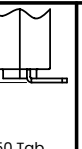
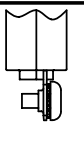
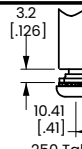
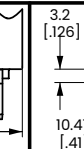
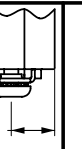
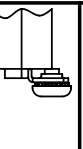
										
.250 Tab	.250 Tab	.250 Tab	.250 Tab	.250 Tab		.250 Tab	.250 Tab		.250 Tab	.250 Tab
TYPE A : Straight	TYPE B : Line Pin	TYPE C : Load Pin	TYPE D : 90° Bend	TYPE E : 90° Bend Backward	TYPE F : Screw Terminal	TYPE G : Mixed Terminals 90° Bend Line	TYPE H : Screw Terminal 90° Bend	TYPE J : Screw Terminal 90° Bend	TYPE R : Screw Terminal without	TYPE K : Mixed Terminals 90° Bend Load

F,G,H,J terminals are 8-32 UNC

Dimensional Specs

inches [millimeters]

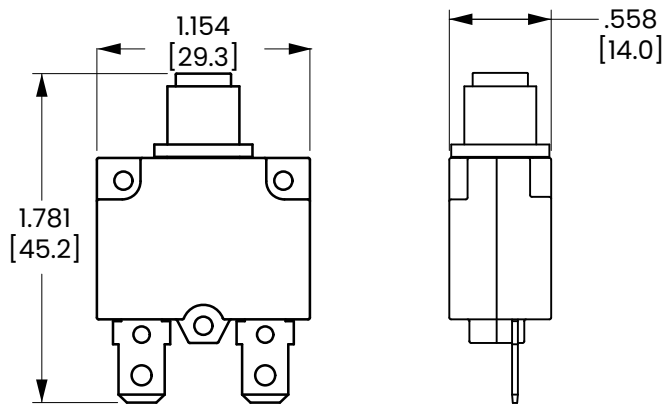

Time Delay

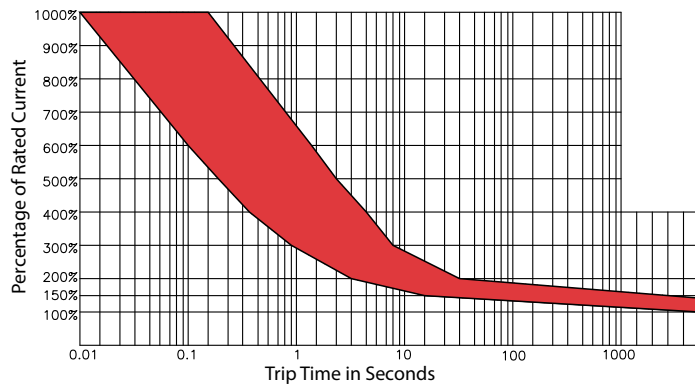

Overload	Trip Time
100%	No Trip
135%	Trip in 1 hr
200%	4.0 ~ 40 sec.
300%	0.9 ~ 8.0 sec.
400%	0.42 ~ 5.0 sec.
500%	0.25 ~ 3.0 sec.
600%	0.01 ~ 1.8 sec.

Trip Time Factor ¹	
-10 °C	x 1.70
-5 °C	x 1.60
0 °C	x 1.50
5 °C	x 1.40
10 °C	x 1.30
15 °C	x 1.20
20 °C	x 1.10
25 °C	x 1.00
30 °C	x 0.90
35 °C	x 0.85
40 °C	x 0.80
45 °C	x 0.75
50 °C	x 0.70
55 °C	x 0.65
60 °C	x 0.60

Notes:
1. Trip Time factor is a guideline that indicates ambient temperature effect on trip times at various overload values.

CTB-Series

Thermal Circuit Breaker

[PRODUCT WEBPAGE](#)

request sample, configure part



The CTB-Series is a compact, single pole, rocker actuated family of thermal circuit breakers designed to protect equipment. Utilizing simple, precision design with few moving parts, these breakers offer cost effective, extremely reliable circuit protection with high resistance against shock and vibration.

1	3-16	125-250	50
Pole	Amps	VAC Max	VDC Max

Typical Applications

- Household Appliances
- Marine
- Medical Equipment
- Exercise Equipment
- On/Off-Highway
- Power Strips and Supplies
- Audio Visual Equipment
- ROHS Compliant

Ordering Scheme

Sample Part Number CTB - B - B - 05 - B

Selection 1 2 3 4 5

1. SERIES

CTB

2. BEZEL COLOR ¹

B Black

3. ROCKER COLOR ¹

B Black

4. RATING

03	3 amps	08	8 amps	14	14 amps
04	4 amps	09	9 amps	15	15 amps
05	5 amps	10	10 amps	16	16 amps
06	6 amps	12	12 amps		
07	7 amps	13	13 amps		

5. PANEL THICKNESS

blank fits standard thickness of .032 - .062
B fits .070 - .110 panel thickness

Notes:

1. Additional colors available. Consult factory.

[Configure Complete Part Number >](#)

[Browse Standard Parts >](#)

Dimensional Specs

inches [millimeters]

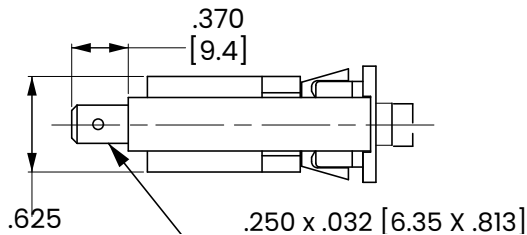
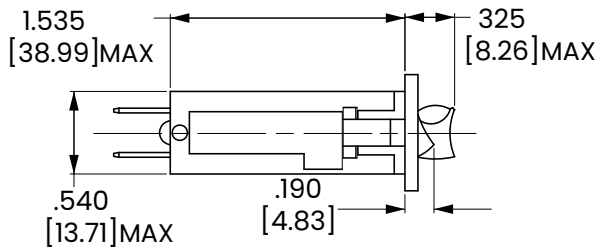

RECOMMENDED PANEL THICKNESS:
 0.032 - 0.062 [0.81-1.57]

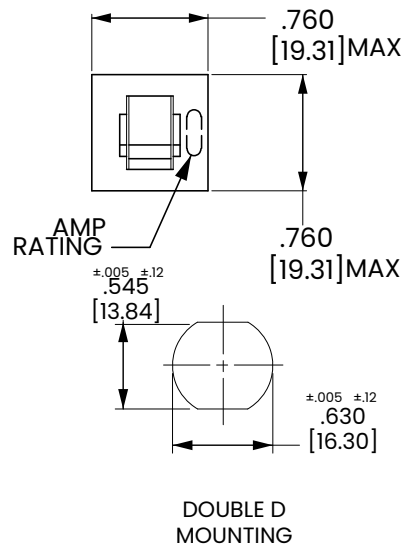

Notes:

Tolerance $\pm .005$ [.127] unless otherwise specified. Breaker must hold 100% of rated current and must trip at 150% and above, within the time limits shown in curve. Trip times specified at 25° ambient with no preloading.

Time Delay

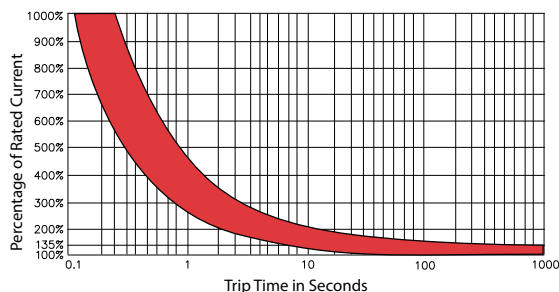

Overload	Trip Time
100%	No Trip
135%	Trip in 1 hr
200%	2.2 ~ 15 sec.
300%	0.9 ~ 3.4 sec.
400%	0.57 ~ 1.6 sec.
500%	0.38 ~ 0.94 sec.
600%	0.27 ~ 0.76 sec.

Correction Factor ¹	
0 °C	x 0.85
10 °C	x 0.90
15 °C	x 0.925
18 °C	x 0.952
25 °C	x 1.00
32 °C	x 1.05
40 °C	x 1.15
50 °C	x 1.39
60 °C	x 1.49

Notes:

1. To adjust the breaker rating for ambient temperature, multiply the breaker rating by the factor. ex: 5A rating x .850 = 4.25A. Select 4A rating.

Authorized Sales Representatives and Distributors

Click on a region of the map below to find your local representatives and distributors or visit www.carlingtech.com/findarep.



About Carling

Founded in 1920, Carling Technologies is a leading manufacturer of electrical and electronic switches and assemblies, circuit breakers, electronic controls, power distribution units, and multiplexed power distribution systems. With six ISO9001 and IATF16949 registered manufacturing facilities and technical sales offices worldwide, Carling Technologies Sales, Service and Engineering teams do much more than manufacture electrical components, they engineer powerful solutions! To learn more about Carling please visit www.carlingtech.com/company-profile.

To view all of Carling's environmental, quality, health & safety certifications please visit www.carlingtech.com/environmental-certifications.



European Headquarters

Carling Technologies LTD
4 Airport Business Park, Exeter Airport,
Clyst Honiton, Exeter, Devon, EX5 2UL, UK
Phone: Int + 44 1392.364422
Email: ltd.sales@carlingtech.com

Worldwide Headquarters

Carling Technologies Inc.
60 Johnson Avenue,
Plainville, CT 06062 USA
Phone: 860.793.9281
Email: sales@carlingtech.com

Asia-Pacific Headquarters

Carling Technologies, Asia-Pacific LTD.,
Suite 1607, 16/F Tower 2, The Gateway, Harbour City, 25
Canton Road, Tsimshatsui, Kowloon, Hong Kong
Phone: Int + 852-2737-2277
Email: sales@carlingtech.com.hk

WWW.CARLINGTECH.COM

