



## ■ Features

- 5"×3" compact size
- 320W convection, 500W force air
- 550W peak power (3sec.)
- Medical safety approved (2 x MOPP) according to ANSI/AAMI ES60601-1 and IEC/EN60601-1
- EMI for both Class I & Class II configuration
- -30~+70°C wide range operating temperature
- No load power consumption < 0.5W by PS\_ON control
- High efficiency up to 94%
- Protections: Short circuit / Overload / Over voltage / Over temperature
- 5Vdc standby output, 12Vdc fan supply, Power Good, Power Fail and remote sense
- Operating altitude up to 4000 meters (Note.5)
- LED indicator for power on
- 3 years warranty

## ■ Applications

- Oral irrigator
- Hemodialysis machine
- Medical computer monitors
- Sleep apnea devices
- Pump machine
- Electric bed

## ■ Description

RPS-500 is a 500W highly reliable green PCB type medical power supply with a high power density on the 5" by 3" footprint. It accepts 80~264VAC input and offers various output voltages between 12V and 48V. The working efficiency is up to 94% and the extremely low no load power consumption is down below 0.5W. RPS-500 (blank type only) is able to be used for both Class I (with FG) and Class II (no FG) system design. The extremely low leakage current is less than 220µA. In addition, it conforms to international medical regulations (2\*MOPP) and EMC EN55011, perfectly fitting all kinds of BF rated "patient contact" medical system equipment. RPS-500 series also offers the enclosed style models( -C / TF / SF )

## ■ Model Encoding

**RPS - 500 - 12 - C**

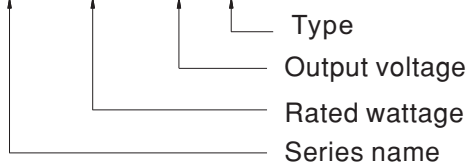

Type	Description	Note
Blank	PCB Type	In stock
-C	Enclosed casing Type	In stock
-TF	Enclosed Type with fan on the top	In stock
-SF	Enclosed Type with fan on the side	In stock



# 500W 5"×3" Reliable Green Medical Power Supply **RPS-500** series

## SPECIFICATION

MODEL		RPS-500-12	RPS-500-15	RPS-500-18	RPS-500-24	RPS-500-27	RPS-500-36	RPS-500-48		
OUTPUT	DC VOLTAGE	12V	15V	18V	24V	27V	36V	48V		
	RATED CURRENT Note.7	Blank	25CFM	41.6A	33.3A	27.8A	20.8A	18.5A	13.9A	10.4A
			Convection	26.7A	21.3A	17.8A	13.4A	11.9A	8.9A	6.7A
		- C	25CFM	41.6A	33.3A	27.8A	20.8A	18.5A	13.9A	10.4A
			Convection	25.8A	20.7A	17.2A	12.9A	11.5A	8.6A	6.5A
	- TF/SF	Built-in fan	41.6A	33.3A	27.8A	20.8A	18.5A	13.9A	10.4A	
	RATED POWER Note.7	Blank	25CFM	499.2W	499.5W	500.4W	499.2W	499.5W	500.4W	499.2W
			Convection	320.4W	319.5W	320.4W	321.6W	321.3W	320.4W	321.6W
		- C	25CFM	499.2W	499.5W	500.4W	499.2W	499.5W	500.4W	499.2W
			Convection	309.6W	310.5W	309.6W	309.6W	310.5W	309.6W	312W
	- TF/SF	Built-in fan	499.2W	499.5W	500.4W	499.2W	499.5W	500.4W	499.2W	
	PEAK POWER(3sec.)	550W								
	RIPPLE & NOISE (max.)	Note.2	200mVp-p	200mVp-p	200mVp-p	200mVp-p	200mVp-p	200mVp-p	200mVp-p	
	VOLTAGE ADJ. RANGE(main output)	11.4~12.6V 14.3~15.8V 17.1~18.9V 22.8~25.2V 25.6~28.4V 34.2~37.8V 45.6~50.4V								
VOLTAGE TOLERANCE	Note.3	±3.0%	±3.0%	±3.0%	±2.0%	±2.0%	±1.0%	±1.0%		
LINE REGULATION	±0.5%									
LOAD REGULATION	±1.0%									
SETUP, RISE TIME	1000ms, 30ms/230VAC 1500ms, 30ms/115VAC at full load									
HOLD UP TIME (Typ.)	10ms/230VAC 10ms/115VAC at full load									
INPUT	VOLTAGE RANGE	Note.4	80 ~ 264VAC	113 ~ 370VDC						
	FREQUENCY RANGE	47 ~ 63Hz								
	POWER FACTOR	PF>0.94/230VAC PF>0.98/115VAC at full load								
	EFFICIENCY (Typ.)	91%	92%	92.5%	93%	93.5%	94%	94%		
	AC CURRENT (Typ.)	5.8A/115VAC 2.9A/230VAC								
	INRUSH CURRENT (Typ.)	COLD START 40A/115VAC 80A/230VAC								
	LEAKAGE CURRENT (max.)	Note.5	Earth leakage current <220μA/264VAC 50Hz , Touch current < 100μA/264VAC							
PROTECTION	OVERLOAD	105 ~ 135% rated output power Protection type : Hiccup mode, recovers automatically after fault condition is removed								
	OVER VOLTAGE	13.2 ~ 15.6V	16.5 ~ 19.5V	19.8 ~ 23.4V	26.4 ~ 31.2V	29.7 ~ 35.1V	39.6 ~ 46.8V	52.8 ~ 62.4V		
	OVER TEMPERATURE	Protection type : Shut down o/p voltage, recovers automatically after temperature goes down								
FUNCTION	5V STANDBY	5Vsb : 5V@0.6A without fan, 1A with fan 25CFM ; Tolerance ±2%, ripple : 120mVp-p(max.)								
	12V FAN SUPPLY	12V@0.5A for driving fan ; Tolerance ±10%								
	PS-ON INPUT SIGNAL	Power ON: PS-ON = "Hi" or "> 2 ~ 5V" ; Power OFF: PS-ON = "Low" or "< 0 ~ 0.5V"								
	POWER GOOD / POWER FAIL	500ms>PG>10ms ; The TTL signal goes high with 10ms to 500ms delay after power set up ; The TTL signal goes low at least 1ms before Vo below 90% of rated value								
ENVIRONMENT	WORKING TEMP.	-30 ~ +70°C (Refer to "Derating Curve")								
	WORKING HUMIDITY	20 ~ 90% RH non-condensing								
	STORAGE TEMP.	-40 ~ +85°C								
	TEMP. COEFFICIENT	±0.03%/°C (0 ~ 50°C)								
	VIBRATION	10 ~ 500Hz, 2G 10min./1cycle, 60min. each along X, Y, Z axes								
	OPERATING ALTITUDE	Note.6	4000 meters							

## SPECIFICATION

SAFETY & EMC (Note 8)	<b>SAFETY STANDARDS</b>	IEC60601-1, TUV EN60601-1, UL ANSI / AAMI ES60601-1 (3.1 version), EAC TP TC 020. CAN/CSA-C22.2 No. 60601-1:14 - Edition 3 approved; Design refer to EN60335-1 (By request)												
	<b>ISOLATION LEVEL</b>	Primary-Secondary: 2xMOPP, Primary-Earth: 1xMOPP, Secondary-Earth: 1xMOPP												
	<b>WITHSTAND VOLTAGE</b>	I/P-O/P: 4KVAC I/P-FG: 2KVAC O/P-FG: 1.5KVAC												
	<b>ISOLATION RESISTANCE</b>	I/P-O/P, I/P-FG: 100M Ohms / 500VDC / 25°C / 70% RH												
	<b>EMC EMISSION</b>	<b>Parameter</b>	<b>Standard</b>	<b>Test Level / Note</b>										
		Conducted emission	EN55011 (CISPR11)	Class I : Class B , Class II : Class A										
		Radiated emission	EN55011 (CISPR11)	Class A										
		Harmonic current	EN61000-3-2	Class A										
	<b>EMC IMMUNITY</b>	EN55024 , EN60601-1-2, EN61204-3												
		<b>Parameter</b>	<b>Standard</b>	<b>Test Level / Note</b>										
ESD		EN61000-4-2	Level 4, 15KV air ; Level 4, 8KV contact											
RF field susceptibility		EN61000-4-3	Level 3, 10V/m( 80MHz~2.7GHz ) Table 9, 9~28V/m( 385MHz~5.78GHz )											
EFT bursts		EN61000-4-4	Level 3, 2KV											
Surge susceptibility		EN61000-4-5	Level 4, 4KV/Line-FG ; 2KV/Line-Line											
Conducted susceptibility		EN61000-4-6	Level 3, 10V											
Magnetic field immunity		EN61000-4-8	Level 4, 30A/m											
<b>OTHERS</b>	<b>MTBF</b>	194.1Khrs min. MIL-HDBK-217F (25°C)												
	<b>DIMENSION</b>	Type	RPS-500	RPS-500-C	RPS-500-TF	RPS-500-SF								
		L*W*H	127x76.2x41mm 5"×3"×1.61"inch	130x86x43mm 5.11"×3.39"×1.69"inch	130x86x66.5mm 5.11"×3.39"×2.62"inch	160x86x43mm 6.3"×3.39"×1.69"inch								
	<b>PACKING</b>	P.W.	0.46Kg	0.54Kg	0.58Kg	0.64Kg								
		Q'TY	30pcs	24pcs	24pcs	24pcs								
G.W.		14.8Kg	14Kg	14.9Kg	16.4Kg									
M'MENT		1.03CUFT	0.77CUFT	0.86CUFT	0.91CUFT									
<b>NOTE</b>	<p>1. All parameters NOT specially mentioned are measured at 230VAC input, rated load and 25 of ambient temperature.</p> <p>2. Ripple &amp; noise are measured at 20MHz of bandwidth by using a 12" twisted pair-wire terminated with a 0.1μf &amp; 47μf parallel capacitor.</p> <p>3. Tolerance : includes set up tolerance, line regulation and load regulation.</p> <p>4. Derating may be needed under low input voltages. Please check the derating curve for more details.</p> <p>5. Touch current was measured from primary input to DC output.</p> <p>6. The ambient temperature derating of 3.5°C/1000m with fanless models and of 5°C/1000m with fan models for operating altitude higher than 2000m(6500ft).</p> <p>7. Please refer to "Derating curve".</p> <p>8. The power supply is considered a component which will be installed into a final equipment. All EMC tests are executed by mounting the unit on a 360mm×360mm metal plate with 1mm of thickness. The final equipment must be re-confirmed that it still meets EMC directives. For guidance on how to perform these EMC tests, please refer to "EMI testing of component power supplies." (as available on <a href="http://www.meanwell.com">http://www.meanwell.com</a>).</p> <table border="1" data-bbox="255 1926 829 2105"> <tr> <td>EMI Performance</td> <td>Conducted</td> <td>Radiated</td> </tr> <tr> <td>Class I (with FG)</td> <td>Class B</td> <td>Class A</td> </tr> <tr> <td>Class II (no FG)</td> <td>Class A</td> <td>Class A</td> </tr> </table>					EMI Performance	Conducted	Radiated	Class I (with FG)	Class B	Class A	Class II (no FG)	Class A	Class A
EMI Performance	Conducted	Radiated												
Class I (with FG)	Class B	Class A												
Class II (no FG)	Class A	Class A												



# 500W 5"×3" Reliable Green Medical Power Supply **RPS-500** series

## Block Diagram

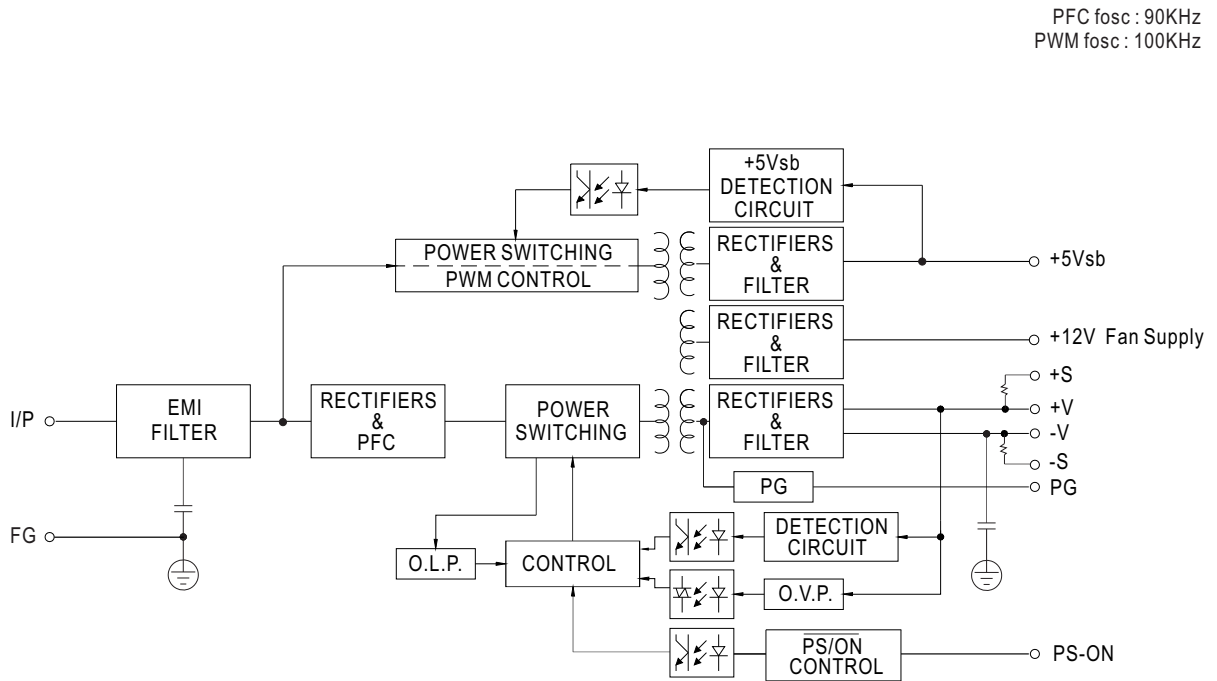

## Output Derating vs Input Voltage

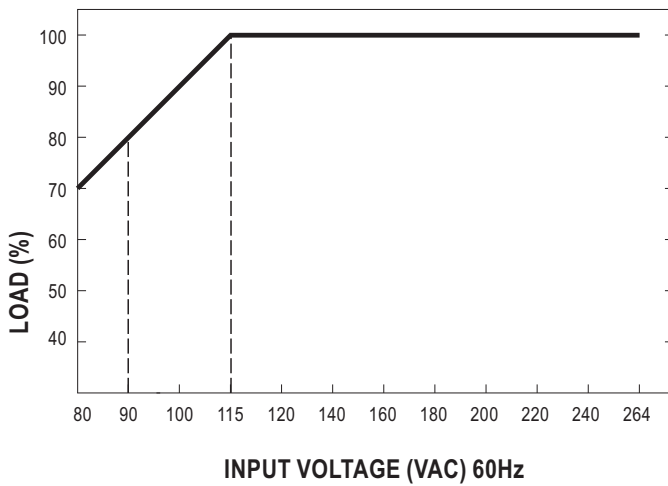

### Derating Curve

○ RPS-500

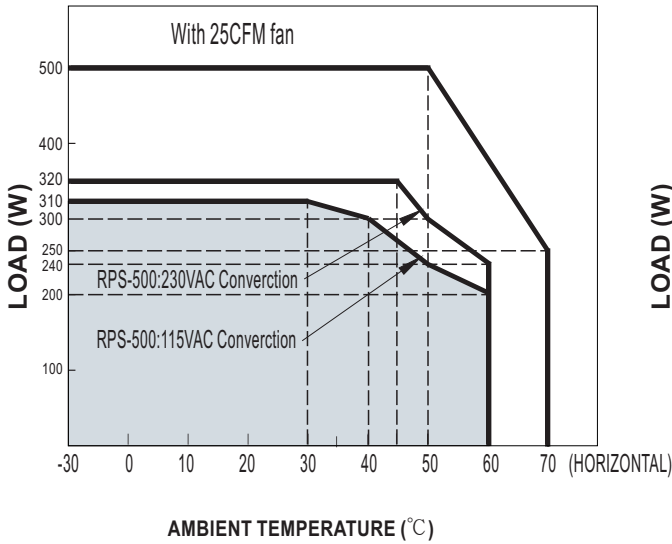

○ RPS-500-C

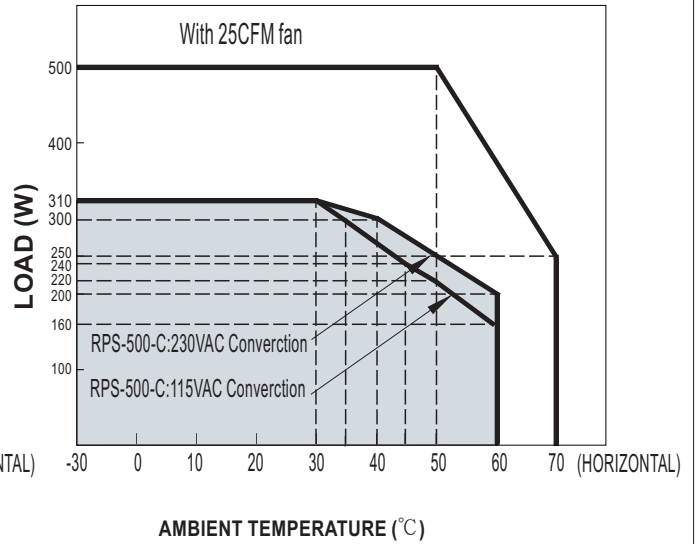

○ RPS-500-TF/SF

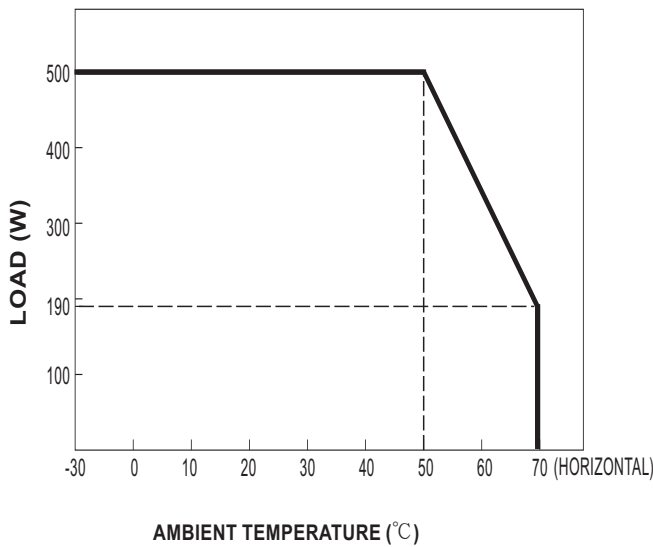

Order No.	RPS-500	RPS-500-C	RPS-500-TF	RPS-500-SF
Products				
Convection	320W	310W	---	---
Force Air	500W	500W	500W	500W

■ Mechanical Specification

● RPS-500 (PCB Type)

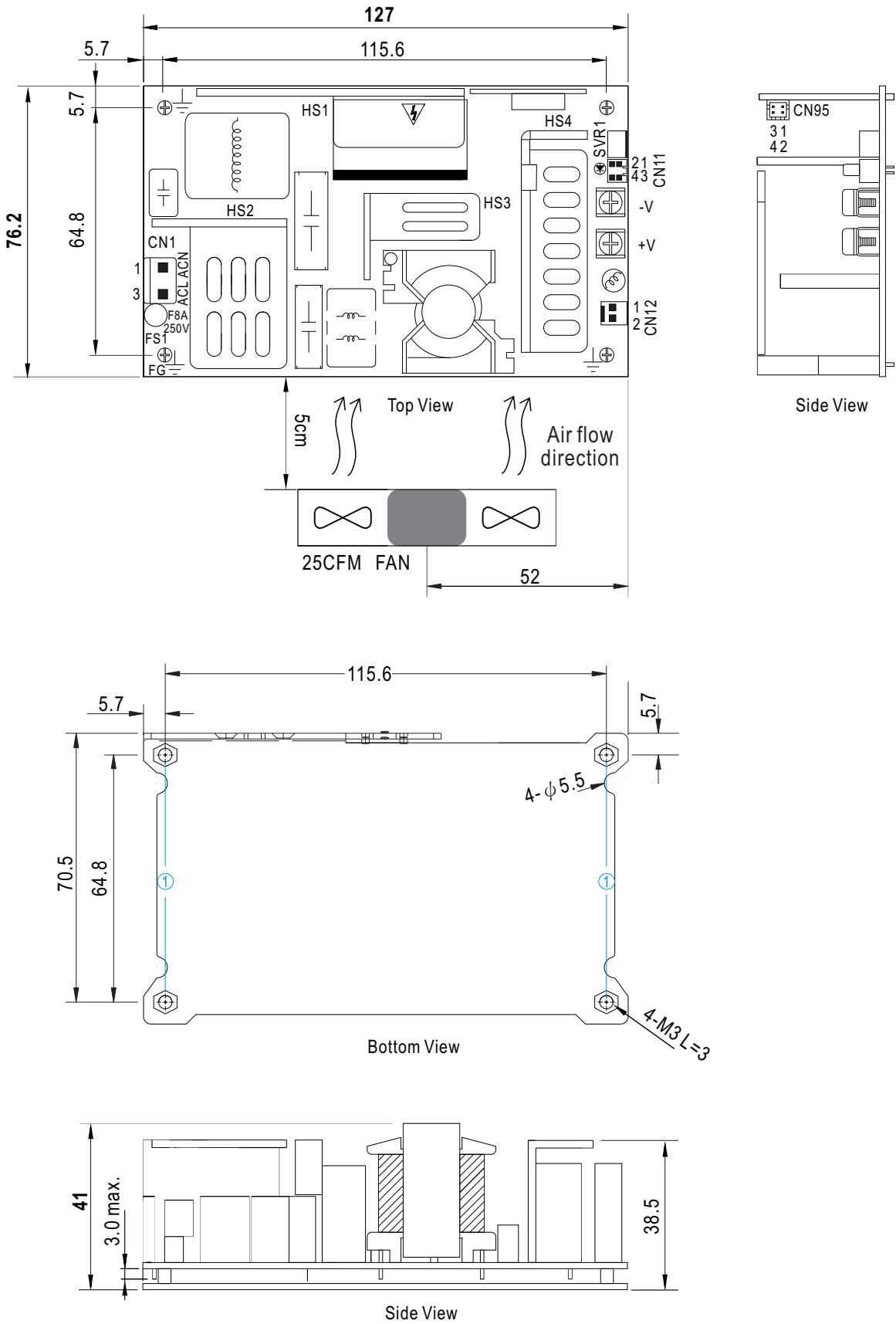

● RPS-500-C (Enclosed type)

Case No. 247C-T 269A-D Unit:mm

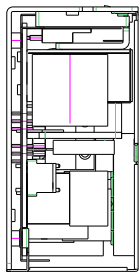
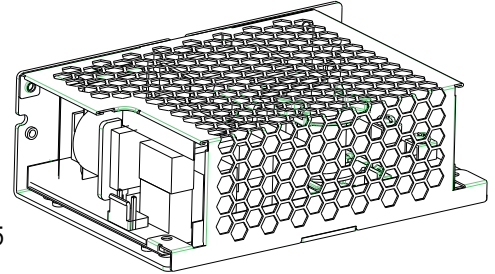
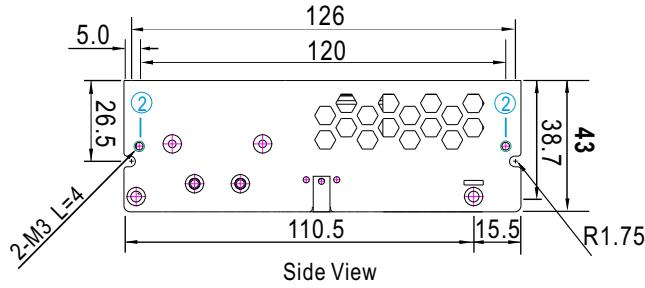

Side View

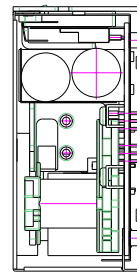
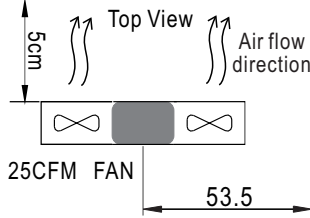
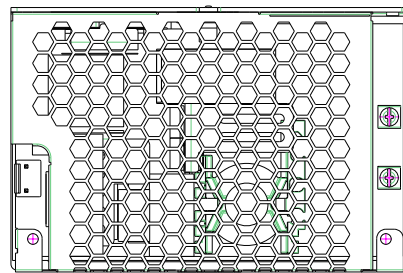

Side View

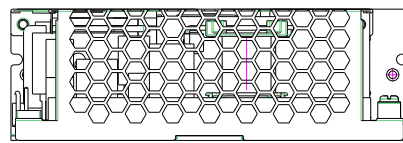

Side View

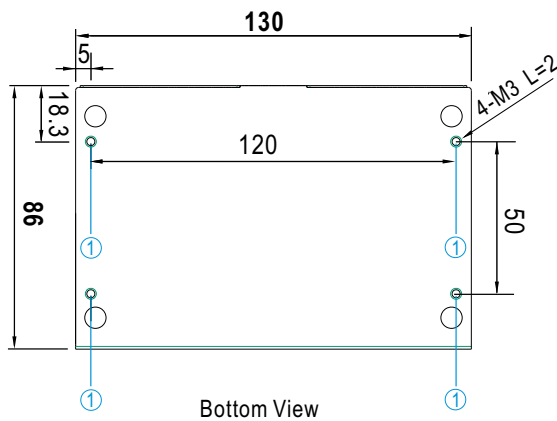



# 500W 5"×3" Reliable Green Medical Power Supply **RPS-500** series

## ● RPS-500-TF (Enclosed type with fan on the top)

Case No. 269A-D 247D-T Unit:mm

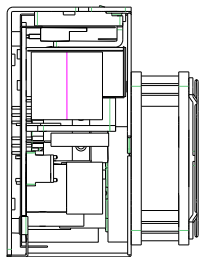
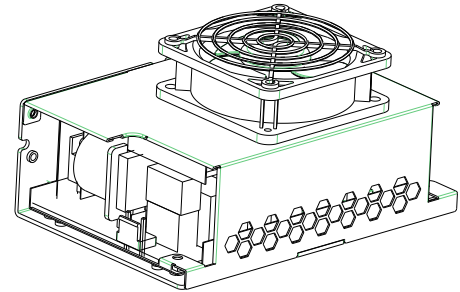
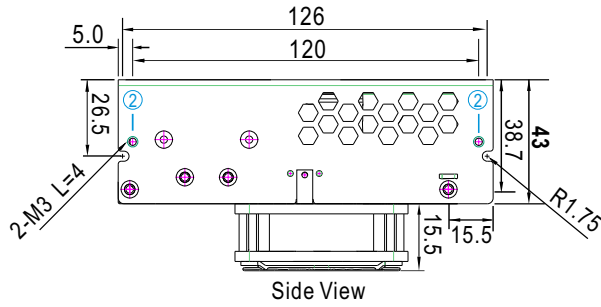

Side View

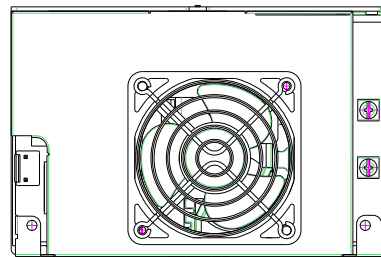

Top View

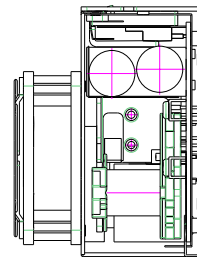

Side View

Air flow direction

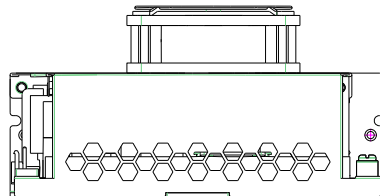

Side View

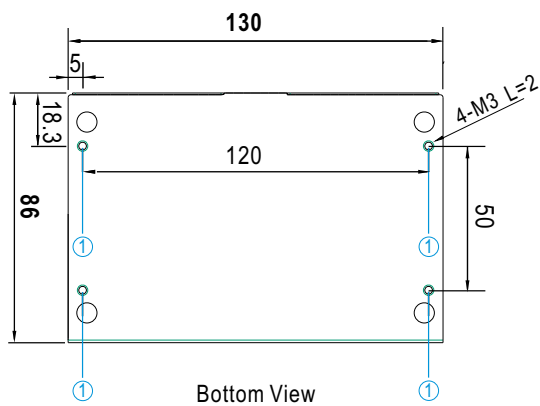





# 500W 5"×3" Reliable Green Medical Power Supply **RPS-500** series

● RPS-500-SF (Enclosed type with fan on the side)

Case No. 248B Unit:mm

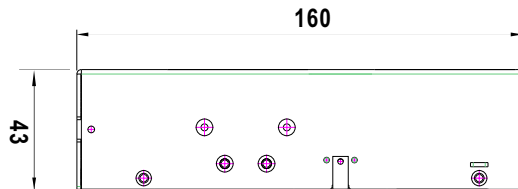
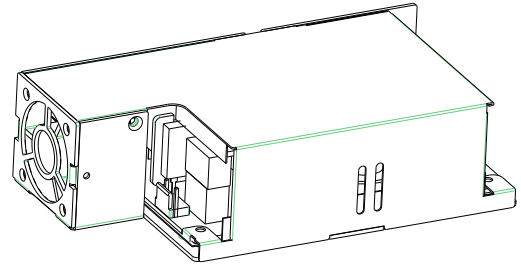

Side View

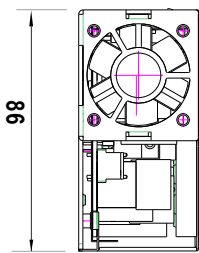

Side View

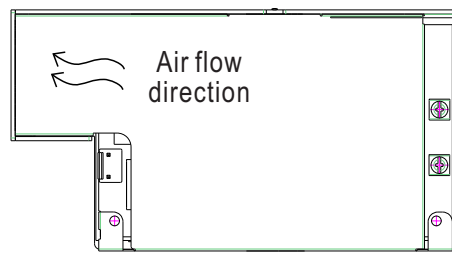

Top View

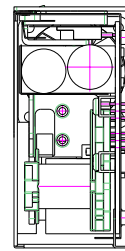

Side View

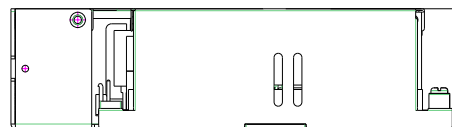

Side View

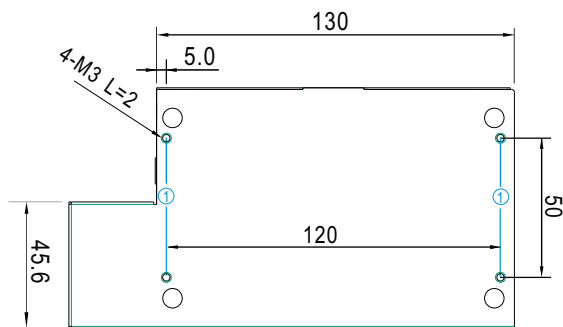

Bottom View

### ※ Mounting Instruction for -C/-TF/-SF Type

Hole No.	Recommended Screw Size	MAX. Penetration Depth L	Recommended mounting torque
①	M3	2mm	4~6Kgf-cm
②	M3	4mm	4~6Kgf-cm

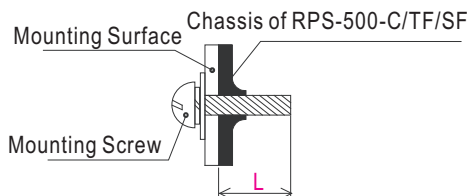

### ※ CONNECTION

AC Input Connector (CN1) : JST B3P-VH or equivalent

Pin No.	Assignment	Mating Housing	Terminal
1	AC/N	JST VHR or equivalent	JST SVH-21T-P1.1 or equivalent
2	No Pin		
3	AC/L		

Function Connector(CN11): TKP DH2I-2X2 or equivalent

Pin No.	Assignment	Mating Housing	Terminal
1	-S	TKP DH2 or equivalent	TKP or equivalent
2	+S		
3	DC COM		
4	PG		

DC Output Connector (CN2,CN3)

Pin No.	Assignment	Output Terminals
CN2	-V	M3.5 Pan HD screw in 2 positions Torque to 8 lbs-in(90cNm)max.
CN3	+V	

Function Connector(CN95): TKP DH2L-2X2 or equivalent

Pin No.	Assignment	Mating Housing	Terminal
1	5Vsb	TKP DH2 or equivalent	TKP or equivalent
2,4	DC COM		
3	PS-ON		

⚠ HS1,HS2,HS3,HS4 can not be shorted

FAN Connector(CN12) : TKP 8812-2 or equivalent  
(Except for RPS-500-TF/SF)

Pin No.	Assignment	Mating Housing	Terminal
1	DC COM	TKP 2502 or equivalent	TKP 8811 or equivalent
2	+12V		

- ※ Note: 1. The enclosed type (-C/TF/SF type) models are not suitable for configuration within a Class II (without FG) system, but suggested within a Class I (with FG) system.  
2. Mounting Instruction for enclosed type.

### ■ Installation Manual

Please refer to : <http://www.meanwell.com/manual.html>