



### ■ Features

- Wide input range 180 ~ 528VAC
- Constant power mode output
- Metal housing with Class I design
- Surge protection with 8KV/4KV
- Built-in active PFC function
- IP67 design for indoor or outdoor installation
- 3 in 1 dimming (dim to off and Isolation); Smart timer dimming and DALI 2.0
- Support with auxiliary DC output 12V/500mA
- Typical lifetime>50000 hours
- 5 years warranty

### ■ Applications

- Harbor lighting
- High-bay lighting
- Flood lighting
- Fishing lamp
- Horticulture lighting
- Stadium lighting
- Type “HL” for use in Class I , Division 2 hazardous (Classified) location.

### ■ Description

HVGC-1000 series is a 1000W LED AC/DC driver featuring the constant power mode with wide output voltage range. HVGC-1000 operates from 180~528VAC and offers models with different rated current ranging between 1320mA and 7000mA. Thanks to the high efficiency up to 96%, with the fanless design, all models are able to operate for -40°C~+90°C case temperature under free air convection. The design of metal housing and IP67 ingress protection level allows this series to fit both indoor and outdoor applications, such as horticulture lighting and stadium light HVGC-1000 is equipped with various function options, such as dimming methodologies, so as to provide the optimal design flexibility for LED lighting system.

### ■ Model Encoding

**HVGC - 1000** **A** - **M** - **AB**

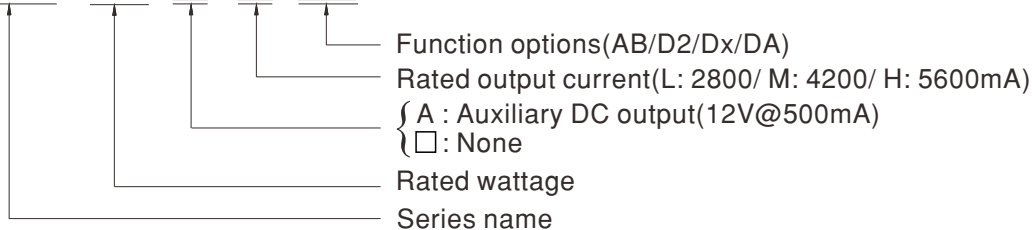

Type	IP Level	Function	Note
AB	IP67	Standard constant power output with 3 in 1 dimming function (0~10Vdc, 10V PWM signal and resistance) and built-in potentiometer.	In Stock
D2	IP67	Built-in Smart timer dimming and programmable function.	By request
Dx	IP67	Built-in Smart timer dimming function by user request.	By request
DA	IP67	DALI 2.0 control technology.	By request

## SPECIFICATION

MODEL		HVGC-1000□-L-□	HVGC-1000□-M-□	HVGC-1000□-H-□	
OUTPUT	RATED CURRENT	2800mA	4200mA	5600mA	
	RATED POWER	1003.2W	1008W	1008W	
	CONSTANT CURRENT REGION <small>Note.2</small>	150 ~ 380V	95 ~ 240V	70 ~ 180V	
	FULL POWER CURRENT RANGE	2640~3280mA	4200~5250mA	5600~7000mA	
	OPEN CIRCUIT VOLTAGE (max.)	400V	250V	190V	
	CURRENT ADJ. RANGE	1320~3280mA	2100~5250mA	2800~7000mA	
	CURRENT RIPPLE	3.0% max. @ rated current			
	CURRENT TOLERANCE	± 5%			
AUXILIARY POWER	Nominal 12V (Tolerance: ± 10%, R&N:150mVp-p)@500mA for HVGC-1000A only				
SET UP TIME <small>Note.4</small>	500ms/230VAC, 347VAC, 480VAC				
INPUT	VOLTAGE RANGE <small>Note.3</small>	180 ~ 528VAC (Please refer to "STATIC CHARACTERISTIC" section)			
	FREQUENCY RANGE	47 ~ 63Hz			
	POWER FACTOR (Typ.)	PF ≥ 0.98 / 230VAC, PF ≥ 0.98 / 277VAC, PF ≥ 0.97 / 347VAC, PF ≥ 0.96 / 400VAC, PF ≥ 0.95 / 480VAC at full load (Please refer to "Power Factor Characteristic" section)			
	TOTAL HARMONIC DISTORTION	THD < 10% @ 347VAC > 80% loading (Please refer to "TOTAL HARMONIC DISTORTION (THD)" section)			
	EFFICIENCY (Typ.)	95.5%	96%	96%	
	AC CURRENT (Typ.)	3.15A / 347VAC	2.28A / 480VAC		
	INRUSH CURRENT(Typ.)	COLD START 40A( <small>twidth=1850μs</small> measured at 50% I <sub>peak</sub> ) at 480VAC; Per NEMA 410			
	MAX. NO. of PSUs on CIRCUIT BREAKER	4 Unit for 30A type B circuit breaker / 8 unit for 30A type C circuit breaker at 480VAC			
	LEAKAGE CURRENT	<0.75mA / 480VAC			
	STANDBY POWER CONSUMPTION	Standby power consumption <2W for AB-Type(Dimming OFF)			
PROTECTION	SHORT CIRCUIT	Constant current limiting, recovers automatically after fault condition is removed			
	OVER VOLTAGE	400 ~ 425V	250 ~ 270V	190 ~ 205V	
	OVER TEMPERATURE	Shut down output voltage, re-power on to recovery			
ENVIRONMENT	WORKING TEMP.	T <sub>case</sub> =-40 ~ +90°C (Please refer to "OUTPUT LOAD vs TEMPERATURE" section)			
	MAX. CASE TEMP.	T <sub>case</sub> =+90°C			
	WORKING HUMIDITY	20 ~ 95% RH non-condensing			
	STORAGE TEMP., HUMIDITY	-40 ~ +80°C, 10 ~ 95% RH non-condensing			
	TEMP. COEFFICIENT	±0.03%/°C (0 ~ 50°C)			
VIBRATION	10 ~ 500Hz, 5G 12min./1cycle, period for 72min. each along X, Y, Z axes				
SAFETY & EMC	SAFETY STANDARDS	UL8750(type "HL"), CAN/CSA C22.2 NO. 250. 13-17, ENEC EN61347-1, EN61347-2-13 independent, EN62384, EAC TP TC 004, IP67, approved			
	WITHSTAND VOLTAGE	I/P-O/P:3KVAC I/P-FG:2KVAC O/P-FG:1.5KVAC			
	ISOLATION RESISTANCE	I/P-O/P, I/P-FG, O/P-FG:100M Ohms / 500VDC / 25°C / 70% RH			
	EMC EMISSION	FCC Part 15 class B, EAC TP TC 020			
		Parameter	Standard		Test Level/Note
		Conducted	EN55015(CISPR15)/GB/T17743		-----
		Radiated	EN55015(CISPR15)/GB/T17743		-----
		Harmonic Current	EN61000-3-2/GB/T17625.1		Class C @load≥50%
	EMC IMMUNITY	Voltage Flicker	EN61000-3-3		-----
		EN61547			
		Parameter	Standard		Test Level/Note
		ESD	EN61000-4-2		Level 3, 8KV air ; Level 2, 4KV contact
		Radiated	EN61000-4-3		Level 2
		EFT/Burst	EN61000-4-4		Level 3
		Surge	EN61000-4-5		4KV/Line-Line 8KV/Line-Earth
Conducted		EN61000-4-6		Level 2	
Magnetic Field	EN61000-4-8		Level 4		
Voltage Dips and Interruptions	EN61000-4-11		>95% dip 0.5 periods, 30% dip 25 periods, >95% interruptions 250 periods		
OTHERS	MTBF	228.3K hrs min. Telcordia SR-332(Bellcore) ; 68.4K hrs min. MIL-HDBK-217F (25°C)			
	DIMENSION	310*144*48.5mm (L*W*H)			
	PACKING	4.2Kg;4pcs/17.8Kg/1.16CUFT			

- NOTE**
- All parameters NOT specially mentioned are measured at 347VAC input, rated current and 25°C of ambient temperature.
  - Please refer to "DRIVING METHODS OF LED MODULE".
  - De-rating may be needed under low input voltages. Please refer to "STATIC CHARACTERISTIC" sections for details.
  - Length of set up time is measured at first cold start. Turning ON/OFF the power supply may lead to increase of the set up time.
  - The driver is considered as a component that will be operated in combination with final equipment. Since EMC performance will be affected by the complete installation, the final equipment manufacturers must re-qualify EMC Directive on the complete installation again.
  - This series meets the typical life expectancy of >50,000 hours of operation when T<sub>case</sub>, particularly t<sub>c</sub> point (or TMP, per DLC), is about 80°C or less.
  - Please refer to the warranty statement on MEAN WELL's website at <http://www.meanwell.com>
  - To fulfill requirements of the latest ErP regulation for lighting fixtures, this LED driver can only be used behind a switch without permanently connected to the mains.
  - The ambient temperature derating of 3.5°C/1000m with fanless models and of 5°C/1000m with fan models for operating altitude higher than 2000m(6500ft).
  - To prevent any Abnormal operation. Please install with two-way switch to AC input.

## ■ BLOCK DIAGRAM

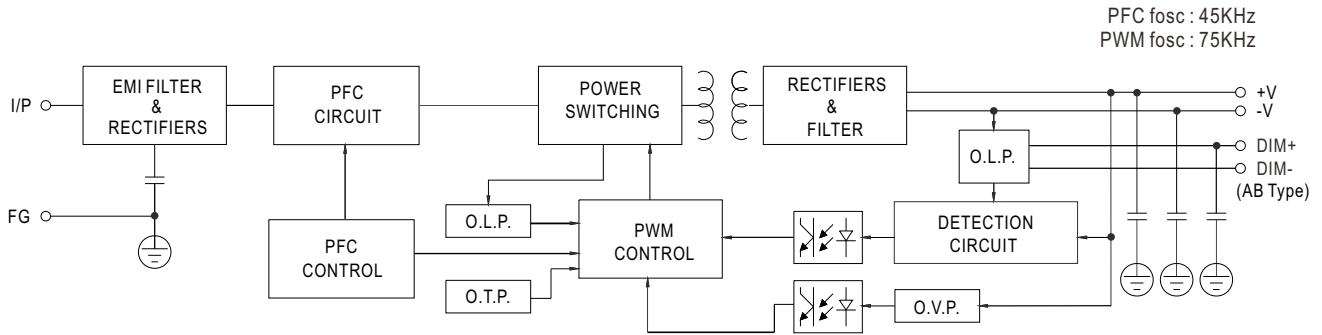

## ■ DRIVING METHODS OF LED MODULE

※ I-V Operating Area

◎ HVGC-1000-L

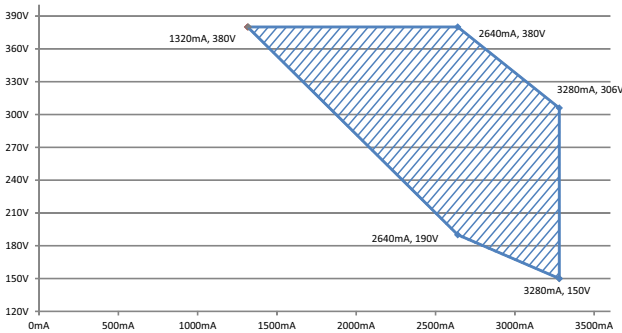

Recommended High Performance Region

◎ HVGC-1000-M

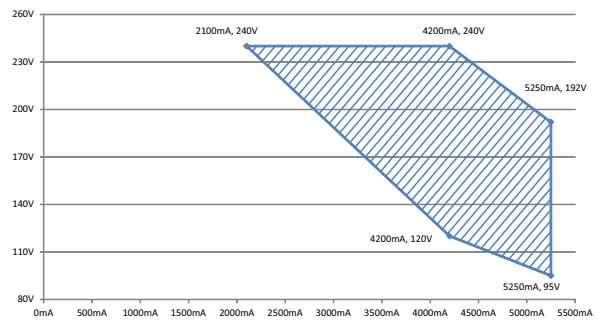

Recommended High Performance Region

◎ HVGC-1000-H

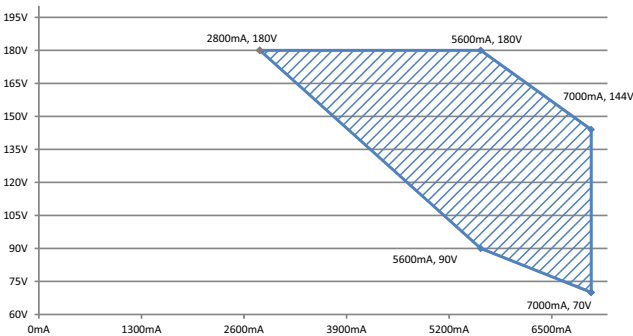

Recommended High Performance Region

**■ DIMMING OPERATION**

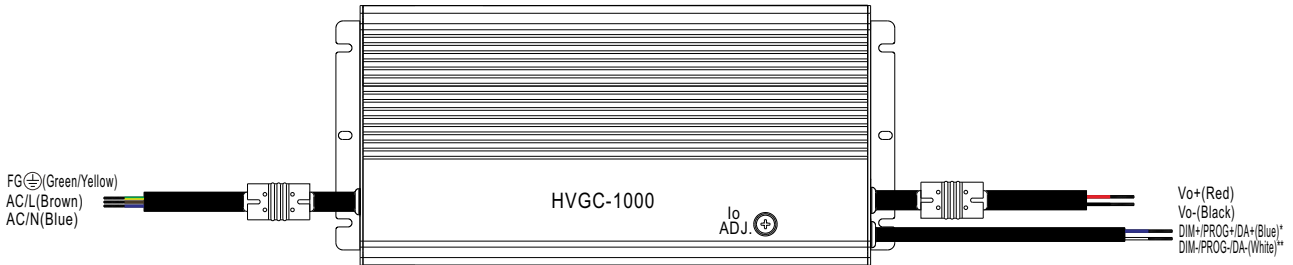

※ **3 in 1 dimming function**

- Output constant current level can be adjusted by applying one of the three methodologies between DIM+ and DIM-: 0 ~ 10VDC, or 10V PWM signal or resistance.
- Direct connecting to LEDs is suggested. It is not suitable to be used with additional drivers.
- Dimming source current from power supply: 100 $\mu$ A (typ.)

\* DIM+ for AB-Type  
 PROG+ for D2-Type  
 DA+ for DA-Type  
 \*\*DIM- for AB-Type  
 PROG- for D2-Type  
 DA- for DA-Type

◎ Applying additive 0 ~ 10VDC

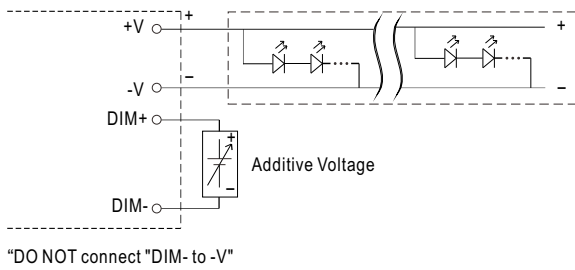

"DO NOT connect "DIM- to -V"

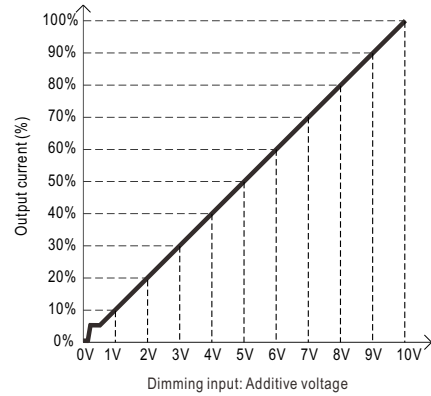

◎ Applying additive 10V PWM signal (frequency range 100Hz ~ 3KHz):

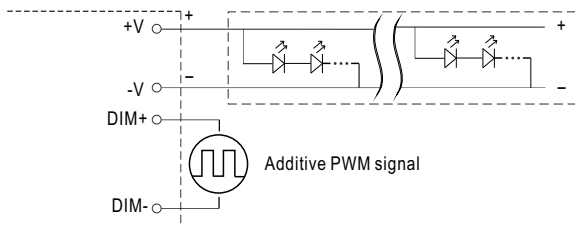

"DO NOT connect "DIM- to -V"

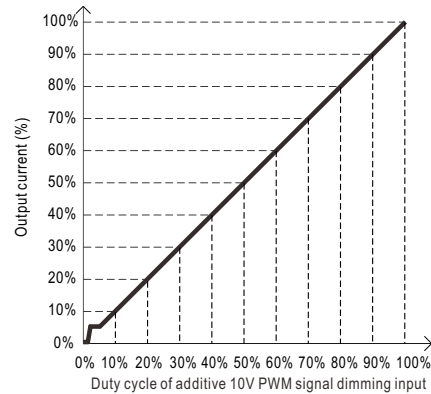

◎ Applying additive resistance:

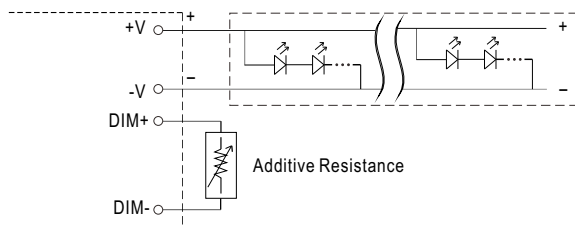

"DO NOT connect "DIM- to -V"

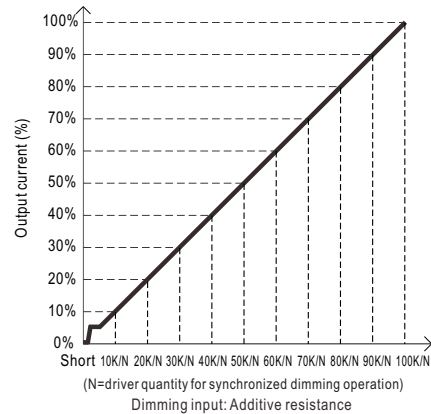

Note : 1. Min. dimming level is about 6% and the output current is not defined when 0% < Iout < 6%.  
 2. The output current could drop down to 0% when dimming input is about 0k $\Omega$  or 0Vdc, or 10V PWM signal with 0% duty cycle.

※ **Smart timer dimming function (for Dxx-Type by User definition)**

MEAN WELL Smart timer dimming primarily provides the adaptive proportion dimming profile for the output constant current level to perform up to 14 consecutive hours. 3 dimming profiles hereunder are defined accounting for the most frequently seen applications. If other options may be needed, please contact MEAN WELL for details.

Ex : ☉ D01-Type: the profile recommended for residential lighting

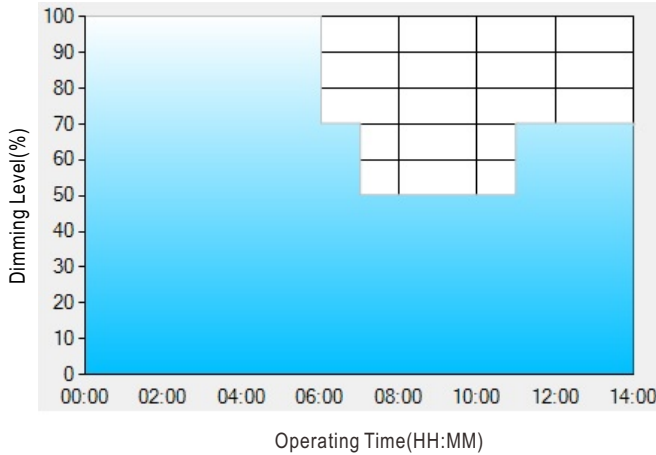

Set up for D01-Type in Smart timer dimming software program:

	T1	T2	T3	T4
TIME**	06:00	07:00	11:00	---
LEVEL**	100%	70%	50%	70%

\*\* : TIME matches Operating Time in the diagram whereas LEVEL matches Dimming Level.

Example: If a residential lighting application adopts D01-Type, when turning on the power supply at 6:00pm, for instance:

- [1] The power supply will switch to the constant current level at 100% starting from 6:00pm.
  - [2] The power supply will switch to the constant current level at 70% in turn, starting from 0:00am, which is 06:00 after the power supply turns on.
  - [3] The power supply will switch to the constant current level at 50% in turn, starting from 1:00am, which is 07:00 after the power supply turns on.
  - [4] The power supply will switch to the constant current level at 70% in turn, starting from 5:00am, which is 11:00 after the power supply turns on.
- The constant current level remains till 8:00am, which is 14:00 after the power supply turns on.

Ex : ☉ D02-Type: the profile recommended for street lighting

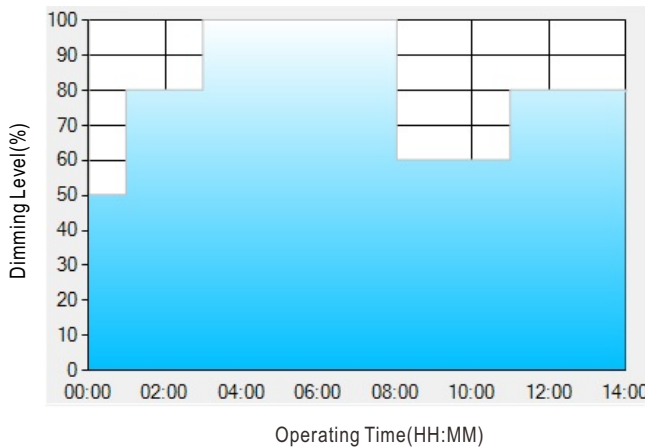

Set up for D02-Type in Smart timer dimming software program:

	T1	T2	T3	T4	T5
TIME**	01:00	03:00	8:00	11:00	---
LEVEL**	50%	80%	100%	60%	80%

\*\* : TIME matches Operating Time in the diagram whereas LEVEL matches Dimming Level.

Example: If a street lighting application adopts D02-Type, when turning on the power supply at 5:00pm, for instance:

- [1] The power supply will switch to the constant current level at 50% starting from 5:00pm.
- [2] The power supply will switch to the constant current level at 80% in turn, starting from 6:00pm, which is 01:00 after the power supply turns on.
- [3] The power supply will switch to the constant current level at 100% in turn, starting from 8:00pm, which is 03:00 after the power supply turns on.
- [4] The power supply will switch to the constant current level at 60% in turn, starting from 1:00am, which is 08:00 after the power supply turns on.
- [5] The power supply will switch to the constant current level at 80% in turn, starting from 4:00am, which is 11:00 after the power supply turns on. The constant current level remains till 6:30am, which is 14:00 after the power supply turns on.

Ex: ☉ D03-Type: the profile recommended for tunnel lighting

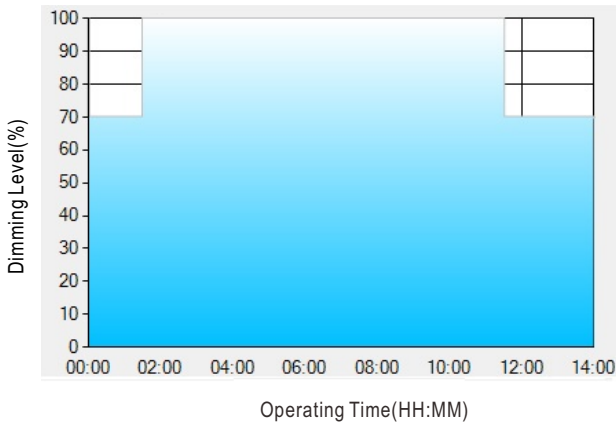

Set up for D03-Type in Smart timer dimming software program:

	T1	T2	T3	T4
TIME**	18:00	20:00	24:00	04:00
LEVEL**	100%	75%	50%	25%

\*\* : TIME matches Operating Time in the diagram whereas LEVEL matches Dimming Level.

Example: If a tunnel lighting application adopts D03-Type, when turning on the power supply at 4:30pm, for instance:

[1] The power supply will switch to the constant current level at 70% starting from 4:30pm.

[2] The power supply will switch to the constant current level at 100% in turn, starting from 6:00pm, which is 01:30 after the power supply turns on.

[3] The power supply will switch to the constant current level at 70% in turn, starting from 5:00am, which is 11:00 after the power supply turns on.

The constant current level remains till 6:30am, which is 14:00 after the power supply turns on.

※ **DALI interface(primary side; for DA-Type)**

- Apply DALI signal between DA+ and DA-.
- DALI protocol comprises 16 groups and 64 addresses.
- First step is fixed at 8% of output.

### OUTPUT LOAD vs TEMPERATURE

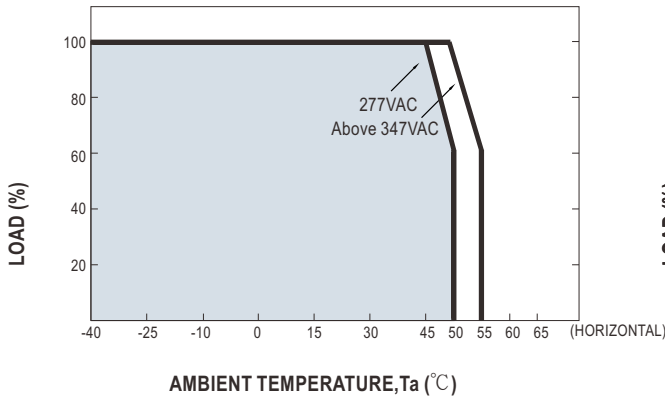

If HVGC-1000 operates in Constant Power mode with the rated current, the maximum workable Ta is 50°C (Typ. 347VAC)

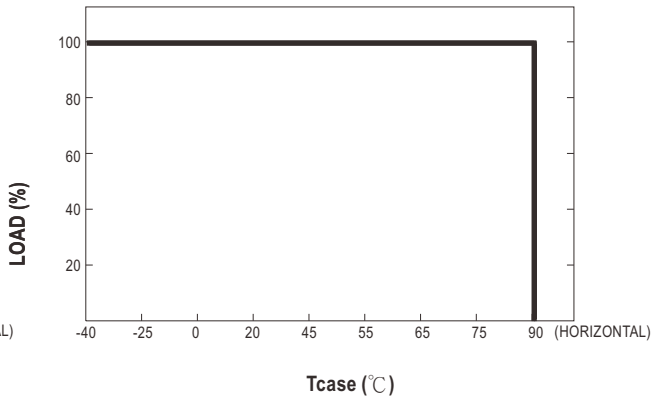

### STATIC CHARACTERISTIC

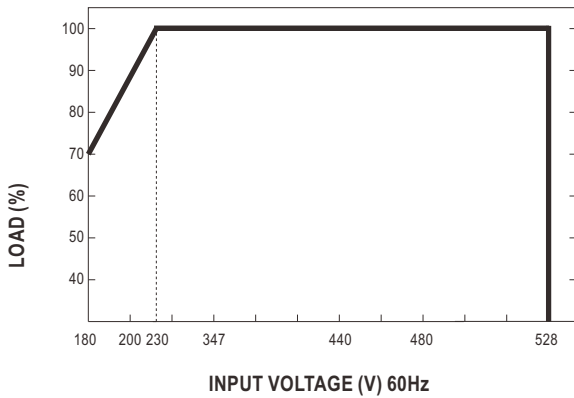

### POWER FACTOR (PF) CHARACTERISTIC

※ Tcase at 80°C

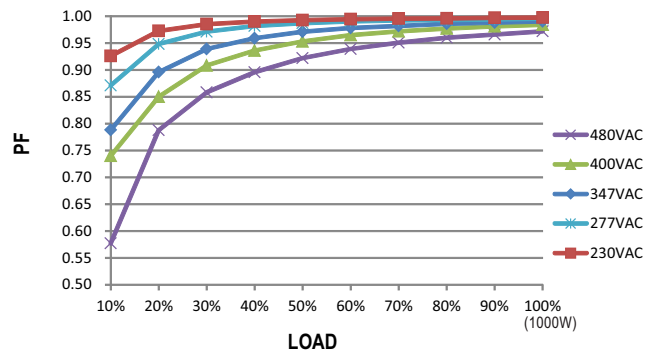

### TOTAL HARMONIC DISTORTION (THD)

※ L Model, Tcase at 80°C

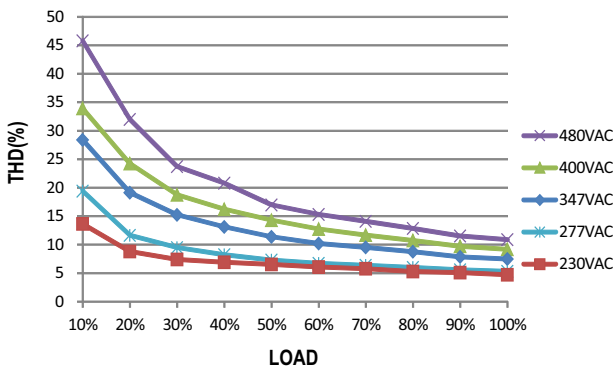

### EFFICIENCY vs LOAD

HVGC-1000 series possess superior working efficiency that up to 95% can be reached in field applications.

※ L Model, Tcase at 80°C

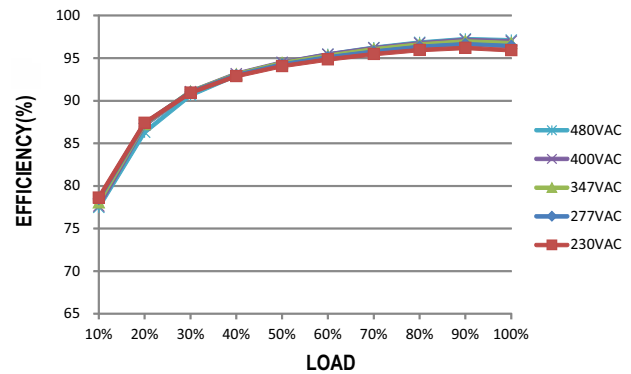

■ LIFE TIME

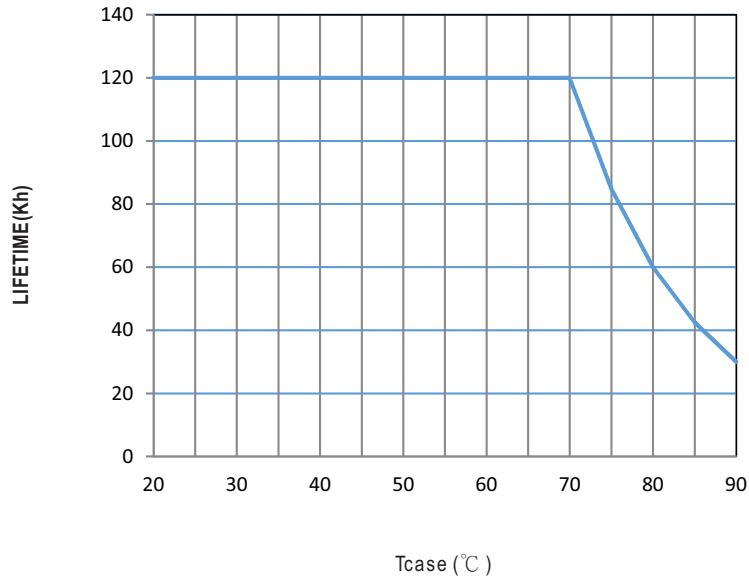

■ MECHANICAL SPECIFICATION

Cable information

Type	Input cable	Output cable	Dimming cable	AUX cable
AB	SOOW 17AWG×3C & H07RN-F 3×1.0mm <sup>2</sup>	SOOW 17AWG×2C & H07RN-F 2×1.0mm <sup>2</sup>	SJOW 17AWG×2C & H05RN-F 2×1.0mm <sup>2</sup>	SJOW 17AWG×2C & H05RN-F 2×1.0mm <sup>2</sup>
D2	SOOW 17AWG×3C & H07RN-F 3×1.0mm <sup>2</sup>	SOOW 17AWG×2C & H07RN-F 2×1.0mm <sup>2</sup>	SJOW 17AWG×2C & H05RN-F 2×1.0mm <sup>2</sup>	SJOW 17AWG×2C & H05RN-F 2×1.0mm <sup>2</sup>
Dx	SOOW 17AWG×3C & H07RN-F 3×1.0mm <sup>2</sup>	SOOW 17AWG×2C & H07RN-F 2×1.0mm <sup>2</sup>	-----	SJOW 17AWG×2C & H05RN-F 2×1.0mm <sup>2</sup>
DA	SOOW 17AWG×3C & H07RN-F 3×1.0mm <sup>2</sup>	SOOW 17AWG×2C & H07RN-F 2×1.0mm <sup>2</sup>	SJOW 17AWG×2C & H05RN-F 2×1.0mm <sup>2</sup>	SJOW 17AWG×2C & H05RN-F 2×1.0mm <sup>2</sup>



## MECHANICAL SPECIFICATION

※HVGC-1000-□-□ without auxiliary power.

Case No. 228 Unit:mm

- = L/M/H type
- = AB/DA types

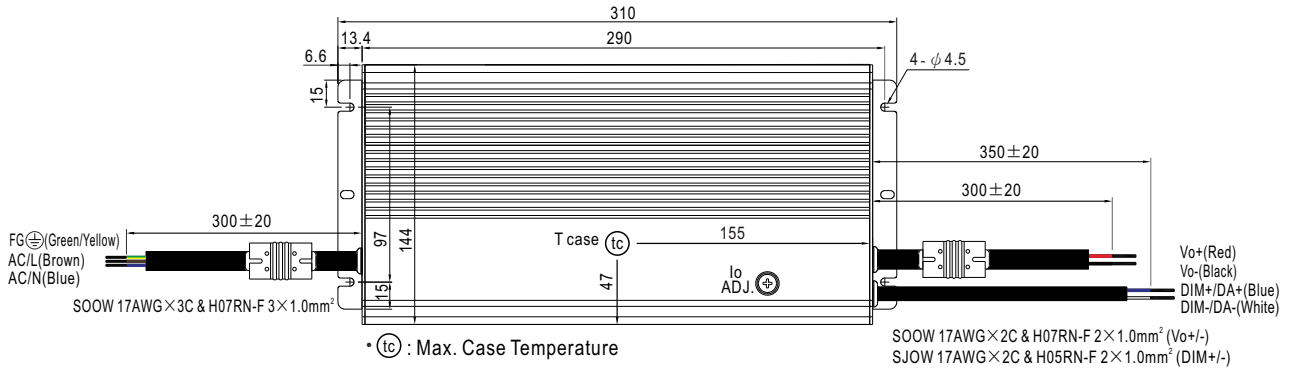

※HVGC-1000A-□-□ with auxiliary power

- = L/M/H type
- = AB/DA types

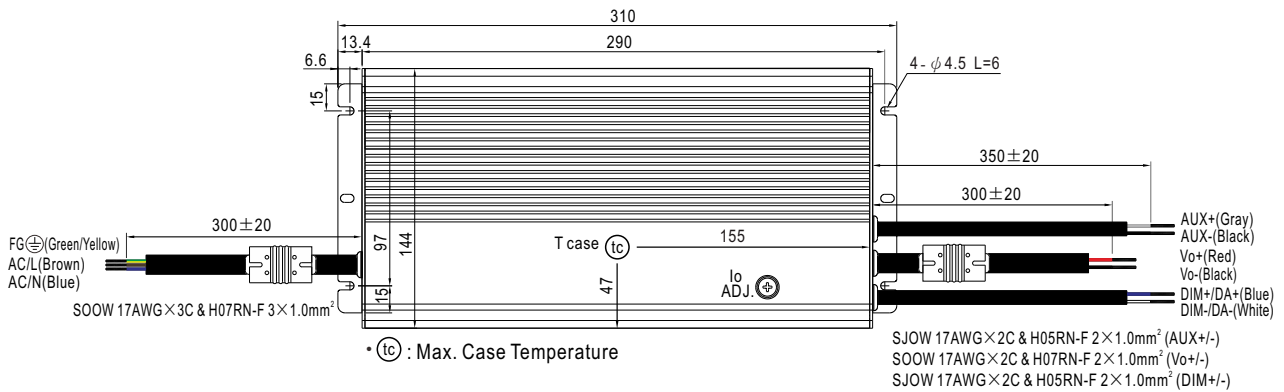

## MECHANICAL SPECIFICATION

※HVGC-1000-□-□ without auxiliary power.

Case No. 228 Unit:mm

□ = L/M/H type

□ = D2 types

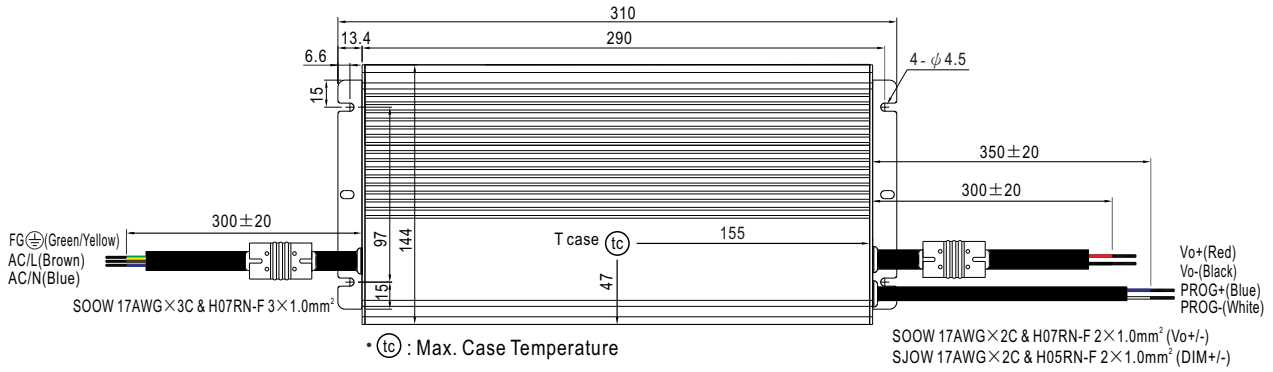

※HVGC-1000A-□-□ with auxiliary power

□ = L/M/H type

□ = D2 types

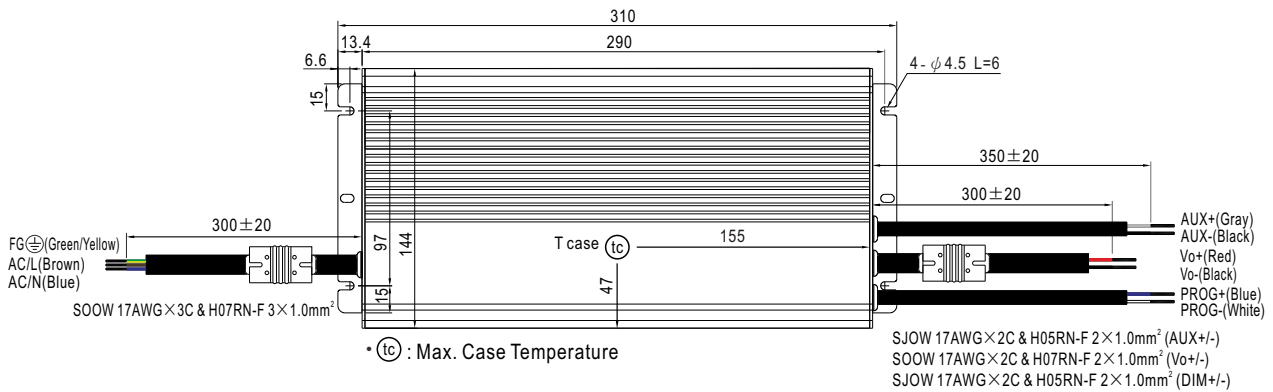

## MECHANICAL SPECIFICATION

※HVGC-1000-□-□ without auxiliary power.

Case No. 228 Unit:mm

□ = L/M/H type

□ = Dx types

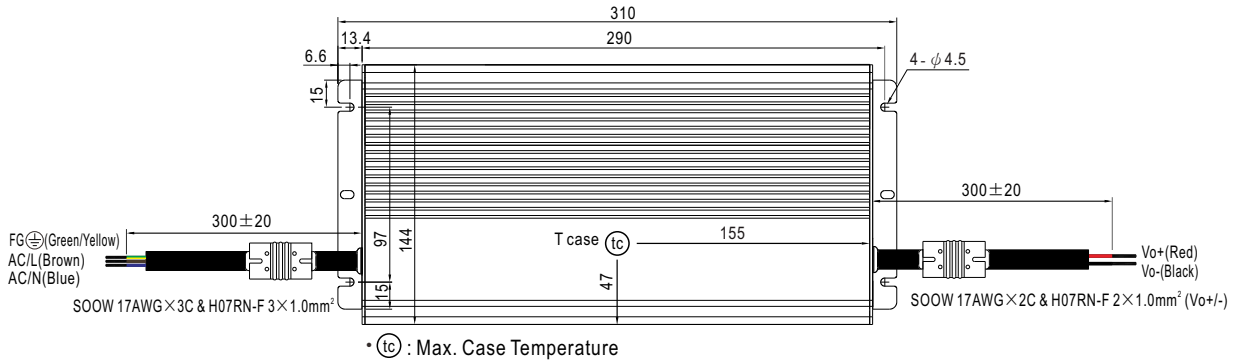

※HVGC-1000A-□-□ with auxiliary power

□ = L/M/H type

□ = Dx types

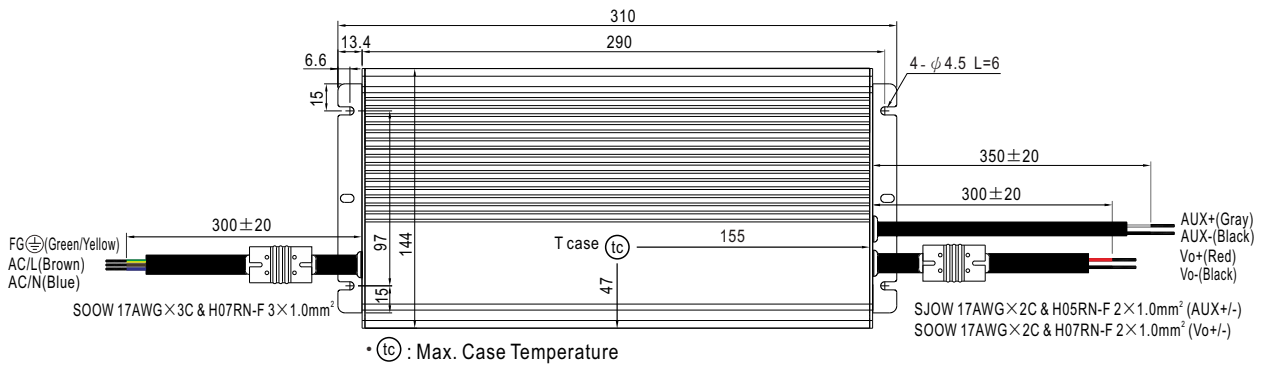

## INSTALLATION MANUAL

Please refer to : <http://www.meanwell.com/manual.html>