

---

### **Economical/Reliable/Ignition Proof**

Series 16 “Push-to-Reset” circuit breakers represents our most popular product family.

Based on a proven “snap-acting” bimetallic thermal sensing element system, Series 16 circuit breakers sense overload conditions and interrupt the flow of current. The resettable actuator mechanism trips, then remains disengaged until manually reset. This trusted family of breakers uses proven technology, and does so at a very economical price.

The Series 16 offer the tightest performance curves available and is compliant to UL1500 Ignition Proof testing.

---

### **A Wide Range of Amperage Ratings**

Series 16 offers amperage ratings from 0.5A to 70.0A - suitable for diverse applications. Calibrated and tested to ensure reliable performance under a variety of assignments and conditions.

The Series 16 is offered in over 2,000 variations to meet your specific application requirements; agency approvals, mounting bushings, amp stamp, trip band indicator, terminals, and hardware.

If the variation you are looking for is not found, contact the factory for assistance.

---

### **Approved for International Use**

Most models in Series 16 conform to UL, CSA, IEC and CCC. As such, those models can be specified into products being designed for export or international use.

**Mechanical Products Company**

phone 517 782 0391 fax 517 788 6773 www.mechprod.com mpsales2@mechprod.com

## Series 16 Physical Configuration

### Physical Attributes/Low-Amperage Models (0.5A to 4.50A) Series 1601, 1681

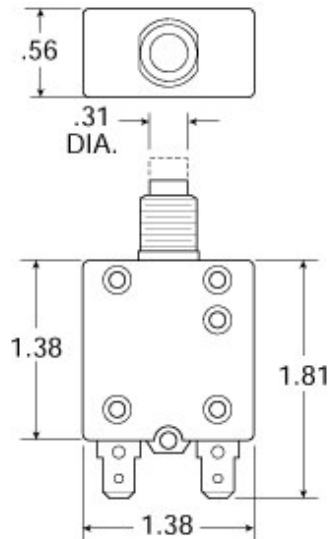

Series 16 models are offered in single-pole configuration. Different variations of terminal, mounting bushings, and actuator graphics can be specified, as required.

### Physical Attributes/Mid-Amperage Models (5A to 35A) Series 1600, 1604, 1610, 1680

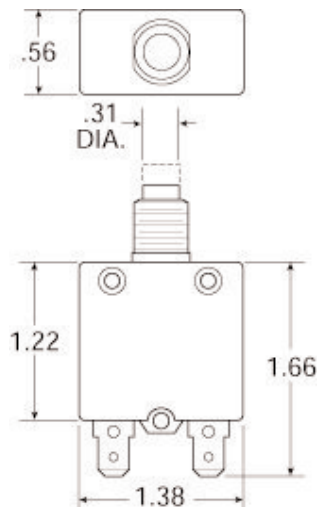

### Physical Attributes/High-Amperage Models (40A to 70A) Series 1648

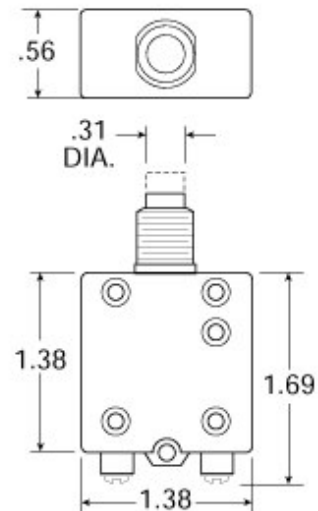

**Note:** All dimensions are in inches.

For applications assistance call 517-782-0391  
FAX 517-788-6773

## Series 16 Physical Configuration *(continued)*

### Mounting Considerations (Bushing Styles/Panel Cutouts)

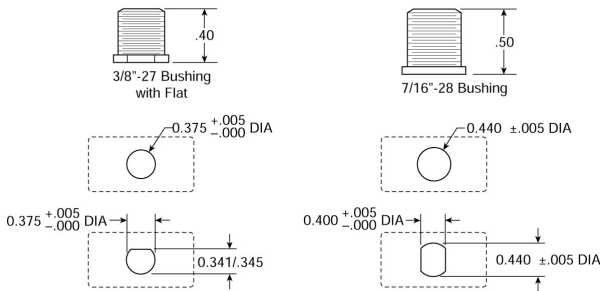

A wide variety of through-the-panel mounting bushings are offered. Please consult part numbering guide to determine availability of specific mounting hardware for individual models. The snap-in mounting method does not require hardware.

### Terminal Considerations

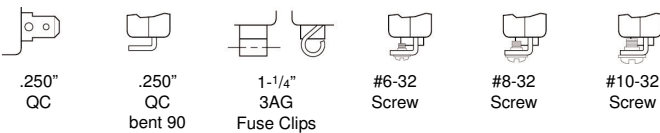

Depending on amperage level and agency requirements, you may specify terminals in any of the following designs:

- .250" quick-connect
- .250" quick-connect, bent 90°
- 1-1/4" 3AG fuse clip terminals
- # 6-32 screw terminals, bent 90°
- # 8-32 screw terminals, bent 90°
- #10-32 screw terminals, bent 90°

For VDE approved screw terminal devices, the use of ring or "U" shaped wire connectors is required.

**Note:** All dimensions are in inches.

### Mechanical Products Company

phone 517 782 0391 fax 517 788 6773 www.mechprod.com mpsales2@mechprod.com

### Snap-In Feature

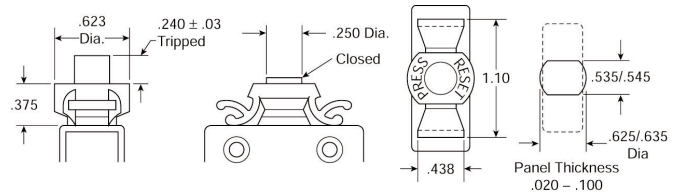

The "Snap-In" design allows for quick and easy installation. The result is the elimination of four assembly steps: 1) adjustment of backup nut, 2) placement of protector, 3) installation of "Press-to-Reset" plate, and 4) threading and tightening of knurlnut. "Press-to-Reset" graphics are molded directly into the collar design, and strong plastic panel grippers ensure secure, long-lasting, rattle-free installation. The 5/8" diameter double-D panel cutout makes replacing fuse holders easy, without changing panels.

U.S. Patent Number 4687164

### Mounting Hardware

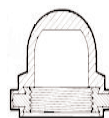
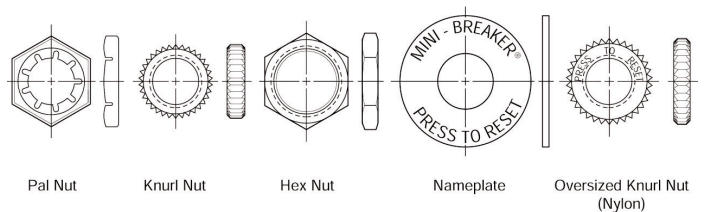

Tough, silicone rubber boots protect breaker and seal mounting hole against harm from washdowns, salt water, lubricants, cleaning solvents, dust, dirt, grease and environmental elements.

## Series 16 Specifications

### Standard Amp Ratings

Series 16 can be specified for 0.50A, 0.75A, 1.0A, 1.5A, 2.0A, 2.5A, 3.0A, 3.2A, 3.5A, 4.0A, 4.5A, 5.0A, 6.0A, 7.0A, 7.5A, 8.0A, 9.0A, 10.0A, 12.0A, 14.0A, 15.0A, 18.0A, 20.0A, 25.0A, 30.0A, 35.0A, 40.0A, 45.0A, 50.0A, 55.0, 60.0A, and 70.0A applications.

### Voltage Ratings

At rated currents up to 35.0A, Series 16 is rated for 250VAC and 50VDC.

At rated currents of 40.0A and above, Series 16 is rated for 250VAC and 32VDC.

### Interrupt Capacity (UL1077)

1,000 A @ 250 VAC	UL
1,000 A @ 50 VDC	UL
2,000 A @ 120 VAC	UL
3,000 A @ 32 VDC	MP <sup>2</sup>

### Overload Capacity

Series 16 overload capacity rating is;  
10X of rated current for 5.0 - 70.0A and  
6X of rated current for 0.5A - 4.5A.

### Ignition Proof

The Series 16 in ratings of 0.5-70 A conforms to USCG Title 33, DFR, Section 183.410(a), per UL1500 testing.

### Dielectric Strength

Series 16 has a dielectric strength that exceeds 1,500V per UL/CSA and 2,000V per VDE.

### Regulatory Approvals

#### Series 16

UL - recognized per STD 1077 (File #E66224)

CSA - certified per STD C22.2 No. 235-04 (File #LR27156)

VDE - licensed to IEC STD 60934 (Licenses #40003670 and #40003682)

#### Series 1600, 1648 and 1680

UL-1500 compliant - Standard for Safety for Ignition-Protection Test for Marine Products. (vibration, shock and ignition-protection testing)

CCC - CQC STD GB17701-1999 (Certificate #2004010307133518)

For ratings not listed, please consult the factory.

Approvals		
Amp Rating	Voltage Rating	Agency Approvals
0.5-25	250VAC/50VDC	UL/CSA/IEC/CCC
26-35	250VAC/32VDC	UL/CSA/IEC/CCC
35-50	250VAC/32VDC	UL/CSA/IEC <sup>1</sup> /CCC
55	32VDC	UL/CSA/IEC <sup>1</sup> /CCC
55	250VAC	MP <sup>2</sup> /IEC <sup>1</sup> /CCC
60-70	250VAC/32VDC	MP <sup>2</sup> /IEC <sup>1</sup> /CCC

<sup>1</sup> - Pending

<sup>2</sup> - Mechanical Products Performance Certified



For applications assistance call 517-782-0391  
FAX 517-788-6773

## Series 16 Operating Characteristics

### Minimum Ultimate Trip

All Series 16 breakers provide a minimum ultimate trip of 100% of rated current at 25°C (77°F).

### Maximum Ultimate Trip

On amperages below 1A, Series 16 models have a maximum ultimate trip of 145% of rated current at 25°C (77°F).

On amperages between 1A and 35A, inclusive, Series 16 models have a maximum ultimate trip of 135% of rated current at 25°C (77°F).

On amperages of 40A and above, Series 16 models have a maximum ultimate trip of 140% of rated current at 25°C (77°F).

### Overload Trip Time Data (in seconds)

Current Rating	200%	300%	400%	500%	600%	800%	1000%
0.5–4.5A	10–32	5–12	3.5–6.3	3.0–4.7	2.3–4.2	–	–
5.0–7.5A	4–15	1.4–5.2	0.75–3.0	0.5–1.8	0.35–1.25	0.2–0.8	0.16–0.66
8–35A	5–30	1.5–7.5	0.8–4.5	0.5–2.8	0.4–1.9	0.2–1.1	0.15–0.78
40–70A	5–30	1.5–7.5	0.8–4.5	0.5–2.8	0.4–1.9	0.2–1.1	0.15–0.78

### Voltage Drop

Ampere Range	Voltage Drop	Ampere Range	Voltage Drop
0.50	3.00V	12.0	0.20V
0.75	3.00V	14.0	0.20V
1.00	1.00V	15.0	0.15V
2.00	1.00V	18.0	0.15V
2.50	1.00V	20.0	0.15V
3.00	1.00V	25.0	0.15V
3.50	1.00V	30.0	0.15V
4.00	1.00V	35.0	0.15V
5.00	0.25V	40.0	0.10V
6.00	0.25V	45.0	0.10V
7.00	0.25V	50.0	0.10V
8.00	0.25V	60.0	0.06V
9.00	0.25V	70.0	0.06V

### Ambient Temperature Correction Factor

Current Rating	25°C/77°F	40°C/104°F	50°C/122°F	60°C/140°F
0.5–4.5A	1.0	1.16	1.33	1.61
5.0–7.5A	1.0	1.32	1.87	Call for info
8–35A	1.0	1.15	1.31	1.55
40–70A	1.0	1.11	1.21	1.34

### Mechanical Products Company

phone 517 782 0391 fax 517 788 6773 www.mechprod.com mpsales2@mechprod.com

## Series 16 Operating Characteristics *(continued)*

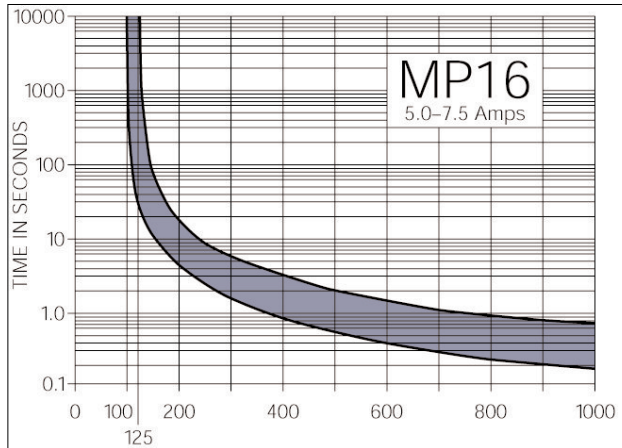
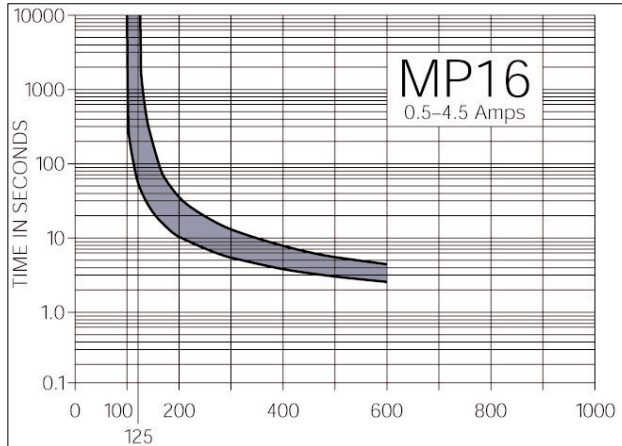

*Trip curves presented here are based on typical samples and are for reference. Please consult the factory for more specific application information.*

*Trip curves are specified at 25°C / 77°F.*

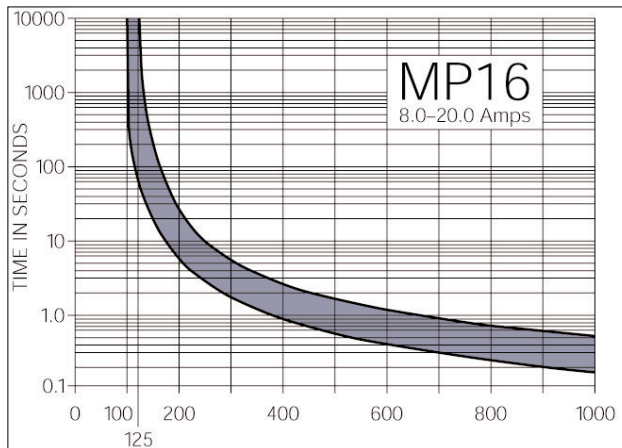

For applications assistance call 517-782-0391  
FAX 517-788-6773

### Series 16 Operating Characteristics *(continued)*

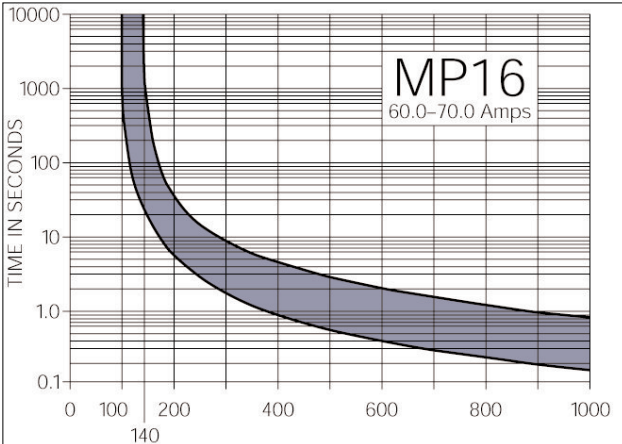
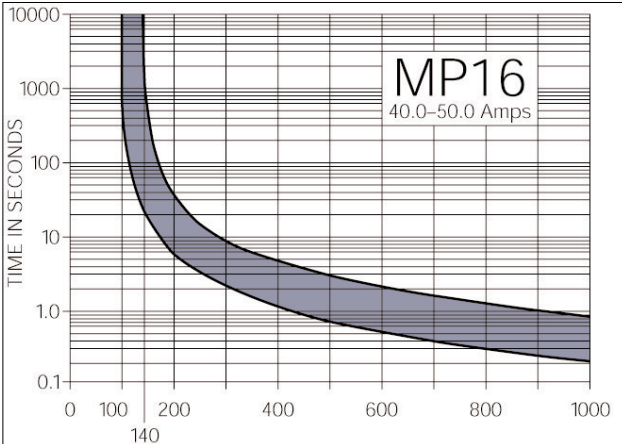
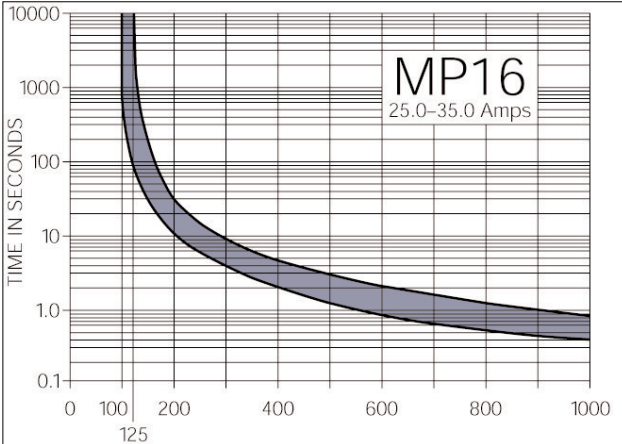

**Mechanical Products Company**

phone 517 782 0391 fax 517 788 6773 www.mechprod.com mpsales2@mechprod.com

1

2

**Series 16 Part Numbering**
**P/N: 16**    -       -

1

BASE CATALOG CODE					
CODE	LO AMP	CODE	MID AMP	CODE	HI AMP
01	0.5 - 4.5 Amp	00	5 - 35 Amp	48	40 - 70 Amp
11	Specials	04	Custom Calibration		
81	3/8"-27 Bushing	10	Specials		
		80	3/8"-27 Bushing		

2

VARIATION CODE					
BASE	GO TO	BASE	GO TO	BASE	GO TO
1601	listings on p.10	1600	listings on p.11	1648	listings on p. 13
1611	Consult Factory	1604	Consult Factory		
1681	listings on p.10	1610	Consult Factory		
		1680	listings on p.12		

VARIATION OPTIONS REFERENCE						
1 - Standard 7/16" bushing is die cast, 3/8" bushing is black nylon, snap-in bushing is black nylon, 7/16" stud is aluminum.						
2 - Anti-rotation provided by means of flats on the bushing - D or Double D (see page 3)						
3- Screw termination provided with: <table style="margin-left: 40px; border: none;"> <tr> <td>0.5 to 25.0 amperes</td> <td># 6-32 NCF screws</td> </tr> <tr> <td>30.0 to 35.0 amperes</td> <td># 8-32 NCF screws</td> </tr> <tr> <td>40.0 to 70.0 amperes</td> <td>#10-32 NCF screws</td> </tr> </table> Lockwashers included, hardware unassembled except for high amp (40 to 70) units.	0.5 to 25.0 amperes	# 6-32 NCF screws	30.0 to 35.0 amperes	# 8-32 NCF screws	40.0 to 70.0 amperes	#10-32 NCF screws
0.5 to 25.0 amperes	# 6-32 NCF screws					
30.0 to 35.0 amperes	# 8-32 NCF screws					
40.0 to 70.0 amperes	#10-32 NCF screws					

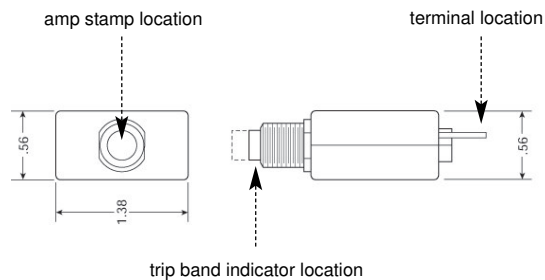
 For applications assistance call 517-782-0391  
 FAX 517-788-6773



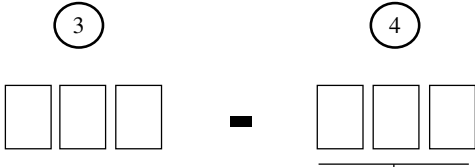

3

CURRENT RATING CODE					
Lo Amp (0.5-4.5)		Mid Amp (5-35)		Hi Amp (40-70)	
CURRENT RATING	CURRENT CODE	CURRENT RATING	CURRENT CODE	CURRENT RATING	CURRENT CODE
0.50	050	5.0	050	40.0	040
0.75	075	6.0	060	45.0	045
1.00	100	7.0	070	50.0	050
2.00	200	7.5	075	55.0	055
2.50	250	8.0	080	60.0	060
3.00	300	9.0	090	70.0	070
3.50	350	10.0	100		
4.00	400	12.0	120		
4.50	450	14.0	140		
		15.0	150		
		18.0	180		
		20.0	200		
		25.0	250		
		30.0	300		
		35.0	350		

4

HARDWARE CODE		
CODE		MOUNTING HARDWARE
<i>7/16"-28</i>	<i>3/8"-27</i>	<i>Common Configurations</i>
011	079	Knurlnut (aluminum)
015	051	Knurlnut/Palnut
007	050	Knurlnut/Palnut/Nameplate
	0D3	Knurlnut (black nylon)
	097	Knurlnut (black nylon)/Lockwasher
006	044	Hexnut (aluminum)
023	054	Hexnut/Hexnut
018	075	Hexnut/Hexnut/Nameplate
000	000	No Hardware
0A0	0A4	Knurlnut/Hexnut, (2) #6 Terminal Screws & Washers
0A1	0A5	Knurlnut/Hexnut/Nameplate, (2) #6 Terminal Screws & Washers
0B4		Protective Rubber Boot/Palnut
000	000	No Hardware

**Mechanical Products Company**

phone 517 782 0391 fax 517 788 6773 www.mechprod.com mpsales2@mechprod.com

**Variation Codes: (Low Amp)**
**1601 VARIATION CODES**

BASE	CODE	AGENCY APPROVAL	BUSHING MOUNTING	BUTTON COLOR	AMP STAMP	TRIP INDICATOR	TERMINAL TYPE
1601-	001	UL, CSA, CCC	7/16"-28 Diecast	White	None	None	0.250" quick connect
1601-	015	UL, CSA, CCC	7/16"-28 Diecast	White	Black	None	0.250" quick connect
1601-	074	UL, CSA, CCC	7/16"-28 Diecast	White	Red	None	0.250" quick connect
1601-	013	UL, CSA, CCC	15/32"-32 Diecast	White	Black	None	#6-32 threaded, bent 90
1601-	067	UL, CSA, CCC	Snap-In Black	White	None	None	0.250" quick connect
1601-	251	UL, CSA, IEC, CCC	Snap-In Black	White	None	None	0.250" quick connect
1601-	252	UL, CSA, IEC, CCC	Snap-In Black	White	Black	None	0.250" quick connect

**1681 VARIATION CODES**

BASE	CODE	AGENCY APPROVAL	BUSHING MOUNTING	BUTTON COLOR	AMP STAMP	TRIP INDICATOR	TERMINAL TYPE
1681-	001	UL, CSA, CCC	3/8"-27 Nylon	White	None	None	0.250" quick connect
1681-	006	UL, CSA, CCC	3/8"-27 Nylon	White	None	Red	0.250" quick connect
1681-	015	UL, CSA, CCC	3/8"-27 Nylon	White	Black	None	0.250" quick connect
1681-	112	UL, CSA, CCC	3/8"-27 Aluminum	Black	on bottom	None	#8-32 threaded, bent 90
1681-	254	UL, CSA, IEC, CCC	3/8"-27 Nylon	White	None	None	0.250" quick connect

*Popular configurations are listed. If the variation you are looking for is not found, contact the factory for assistance. MP has over 2,000 variations and custom requirements is our specialty - electrical, mechanical, environmental and agency approval capabilities.*

For applications assistance call 517-782-0391  
 FAX 517-788-6773

## Variation Codes *(Mid Amp)*

1600 VARIATION CODES							
BASE	CODE	AGENCY APPROVAL	BUSHING MOUNTING	BUTTON COLOR	AMP STAMP	TRIP INDICATOR	TERMINAL TYPE
1600-	001	UL, CSA, CCC	7/16"-28 Diecast	White	None	None	0.250" quick connect
1600-	055	UL, CSA, CCC	7/16"-28 Diecast	White	None	None	#6-32 threaded, bent 90
1600-	025	UL, CSA, CCC	7/16"-28 Diecast	White	None	None	(1) 0.250" quick connect (1) 0.250" quick connect, bent 90
1600-	235	UL, CSA, CCC	7/16"-28 Diecast	White	None	None	(1) #8-32 threaded, bent 90 (1) 0.250" quick connect
1600-	037	UL, CSA, CCC	7/16"-28 Diecast	White	Black	None	0.250" quick connect
1600-	082	UL, CSA, CCC	7/16"-28 Diecast	White	Black	None	#6-32 threaded, bent 90
1600-	007	UL, CSA, CCC	15/32"-32 Diecast	White	None	None	0.250" quick connect
1600-	102	UL, CSA, CCC	15/32"-32 Diecast	White	Red	None	0.250" quick connect
1600-	107	UL, CSA, CCC	15/32"-32 Diecast	White	Red	None	0.250" quick connect
1600-	111	UL, CSA, CCC	15/32"-32 Diecast	White	Black	None	#6-32 threaded, bent 90
1600-	144	UL, CSA, CCC	Snap-In Black	White	None	None	0.250" quick connect
1600-	175	UL, CSA, CCC	Snap-In Black	White	None	None	#8-32 threaded, bent 90
1600-	254	UL, CSA, IEC, CCC	Snap-In Black	White	None	None	0.250" quick connect
1600-	255	UL, CSA, IEC, CCC	Snap-In Black	White	Black	None	0.250" quick connect
1600-	263	UL, CSA, IEC, CCC	Snap-In Black	White	None	None	0.250" quick connect, bent 90

### Mechanical Products Company

phone 517 782 0391 fax 517 788 6773 www.mechprod.com mpsales2@mechprod.com

## Variation Codes *(Mid Amp)*

1680 VARIATION CODES							
BASE	CODE	AGENCY APPROVAL	BUSHING MOUNTING	BUTTON COLOR	AMP STAMP	TRIP INDICATOR	TERMINAL TYPE
1680-	001	UL, CSA, CCC	3/8"-27 Nylon	White	None	None	0.250" quick connect
1680-	055	UL, CSA, CCC	3/8"-27 Nylon	White	None	None	#6-32 threaded, bent 90
1680-	037	UL, CSA, CCC	3/8"-27 Nylon	White	Black	None	0.250" quick connect
1680-	082	UL, CSA, CCC	3/8"-27 Nylon	White	Black	None	#6-32 threaded, bent 90
1680-	109	UL, CSA, CCC	3/8"-27 Nylon	White	Black	Red	0.250" quick connect
1680-	228	UL, CSA, CCC	3/8"-27 Nylon	Black	None	None	0.250" quick connect
1680-	217	UL, CSA, CCC	3/8"-27 Nylon	Black	None	White	0.250" quick connect
1680-	219	UL, CSA, CCC	3/8"-27 Nylon	Black	None	White	#8-32 threaded, bent 90
1680	252	UL, CSA, IEC, CCC	3/8"-27 Nylon	White	None	None	0.250" quick connect
1680	253	UL, CSA, IEC, CCC	3/8"-27 Nylon	White	Black	None	0.250" quick connect

*Popular configurations are listed. If the variation you are looking for is not found, contact the factory for assistance. MP has over 2,000 variations and custom requirements is our specialty - electrical, mechanical, environmental and agency approval capabilities.*

For applications assistance call 517-782-0391  
 FAX 517-788-6773

## Variation Codes *(Hi Amp)*

1648 VARIATION CODES							
BASE	CODE	AGENCY APPROVAL	BUSHING MOUNTING	BUTTON COLOR	AMP STAMP	TRIP INDICATOR	TERMINAL TYPE
1648-	010	MP, consult factory	3/8"-27 Metal	White	None	None	#10-32 threaded, bent 90
1648-	025	MP, consult factory	3/8"-27 Nylon	White	Black	None	#10-32 threaded, bent 90
1648-	006	MP, consult factory	7/16"-28 Diecast	White	None	None	#10-32 threaded, bent 90
1648-	009	MP, consult factory	7/16"-28 Diecast	White	Black	None	#10-32 threaded, bent 90
1648-	001	MP, consult factory	15/32"-32 Diecast	White	Black	None	#10-32 threaded, bent 90
1648-	040	MP, consult factory	15/32"-32 Diecast	White	Red	None	#10-32 threaded, bent 90
1648-	003	MP, consult factory	15/32"-32 Diecast	Black	White	None	#10-32 threaded, bent 90
1648-	016	MP, consult factory	Snap-In Gray	White	None	None	#10-32 threaded, bent 90
1648-	017	UL, CSA, CCC	Snap-In Black	White	None	None	#10-32 threaded, bent 90
1648-	043	MP, consult factory	Auto-Reset	N/A	N/A	N/A	#10-32 threaded, bent 90

**Mechanical Products Company**

phone 517 782 0391 fax 517 788 6773 www.mechprod.com mpsales2@mechprod.com