

Dissipateur thermique Heatsink

WF112100

Rth: 1K/W

- Dissipateur thermique pour relais statique 22.5mm **celpac** SA & SU
Heatsink for 22.5mm **SA & SU celpac** Solid State Relay
- Utiliser de la graisse thermique ou un thermal PAD avec les vis et les couples de serrage péconisés.
Use thermal grease or thermal PAD with adapted screws and washers at the right mounting torque.

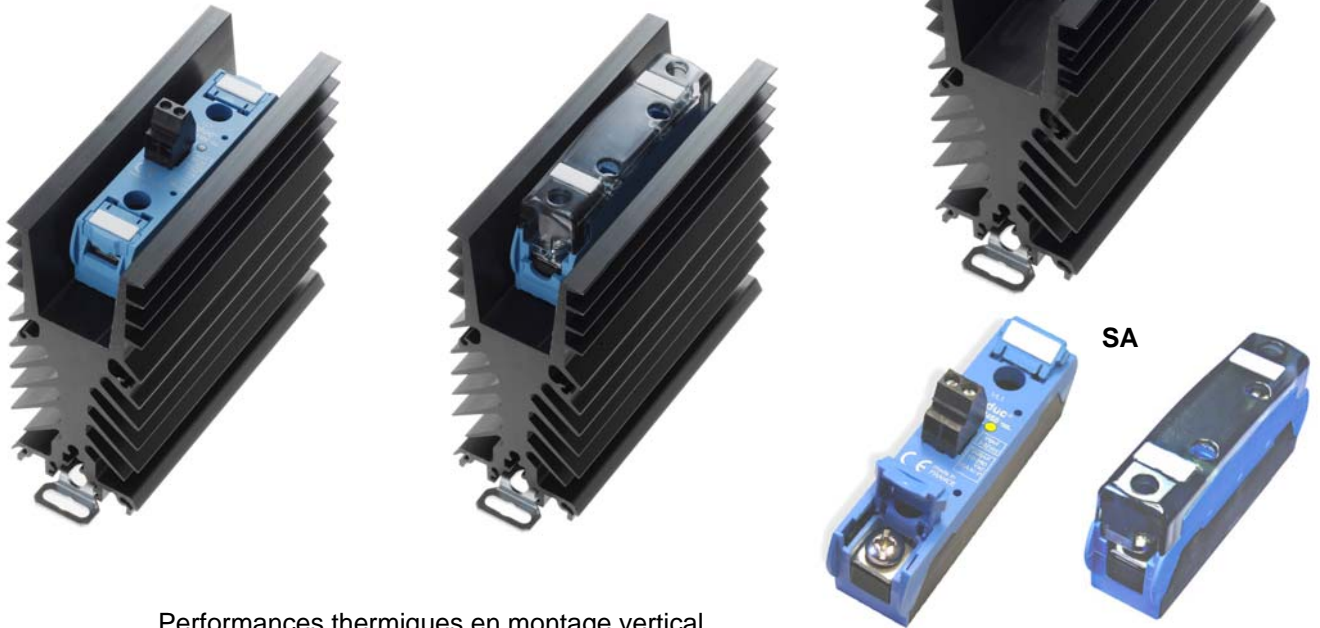

Performances thermiques en montage vertical
Thermal performances in vertical mounting

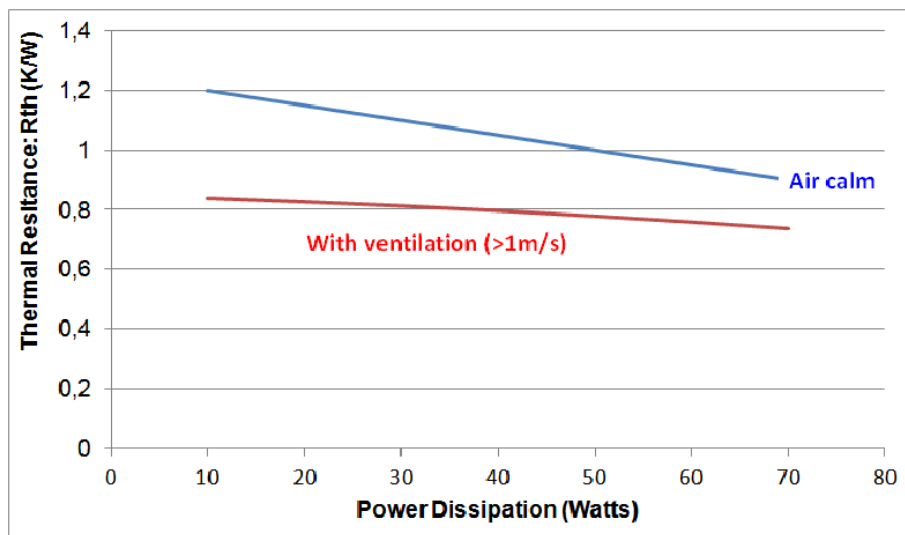

Proud to serve you

celduc®
r e l a i s

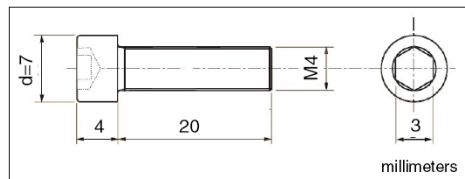
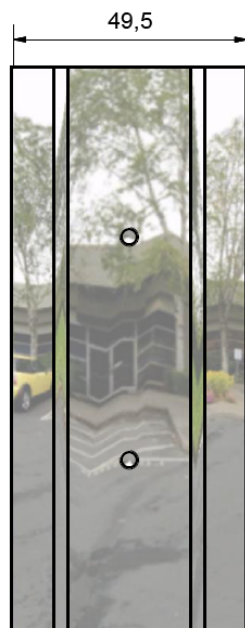
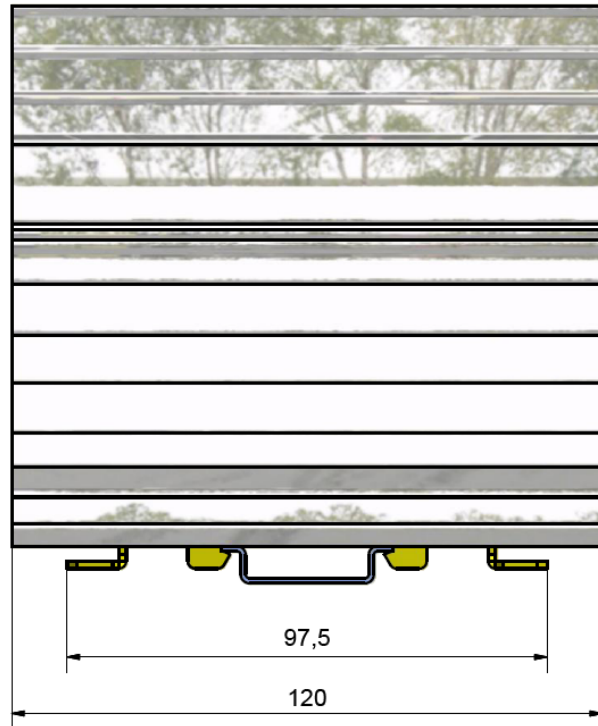
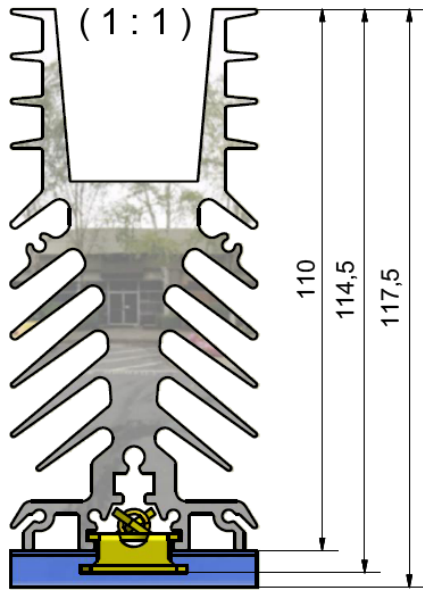

1L184200
Screws M4x20 stainless A2

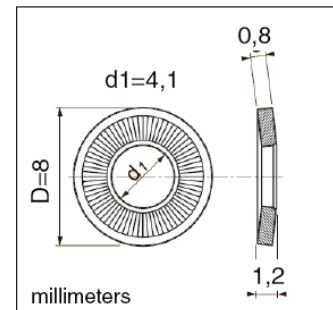

1L344000
washer Ø8
bright zinc plated or
stainless A2

Couple de serrage préconisé pour les 2 vis : 1.8Nm
Advise torque for the 2 screws : 1.8Nm