

SBE®80 / SBO® 60 Connectors - up to 80 Amps



SBE® and SBO® connectors build on the capability of the two pole SB® connectors by offering up to 8 auxiliary power / signal contacts along with an IEC 60950 touch safe housing. The center of the main connector features a connector holder for either: two PP15-45, two PPMX, or APP's innovative 1x4 auxiliary connector.

- **Touch Safe Interface**
Minimizes potential contact with live circuits per IEC 60950
- **Up to 8 Last Mate / First Break Auxiliary's**
Enables intelligent power switching, CAN and interlock loop circuitry, as well as power up to 20 amps per pole
- **Silver Plated Wire Contacts up to #4 (25 mm²)**
Allows UL rated currents up to 80 amps per pole

| SBE®80 / SBO®60 ORDERING INFORMATION |

SBE®80 / SBO®60 Housings

The smallest size of SBE®, X, O style housing. SBE® housings are molded from a chemical resistant PBT. SBO® housings are molded from PC. SBE®80 and SBO®60 housings of the same Voltage Color Code can be mated but is not recommended as it invalidates UL approvals. SBO®60 housings do not meet EN1175-1 requirements for industrial trucks.

| Description | Voltage Color Code | ----- SBE®80 Part Numbers ----- | | ----- SBO®60 Part Numbers ----- | |
|-----------------------|--------------------|---------------------------------|----------|---------------------------------|----------|
| | | 400 | 25 | 400 | 25 |
| Minimum Quantity | | 400 | 25 | 400 | 25 |
| Yellow | 12V | SBE80YEL-BK | SBE80YEL | SBO60YEL-BK | SBO60YEL |
| Orange | 18V | SBE80ORN-BK | SBE80ORN | SBO60ORN-BK | SBO60ORN |
| Red | 24V | SBE80RED-BK | SBE80RED | SBO60RED-BK | SBO60RED |
| Gray | 36V | SBE80GRA-BK | SBE80GRA | N/A | N/A |
| White | 144V | N/A | N/A | SBO60WHT-BK | SBO60WHT |

SBE®80 / SBO®60 Silver Plated Primary Power Wire Contacts

Use two silver plated contacts per housing for the best electrical performance and durability up to 10,000 mating cycles.

| AWG | mm ² | Mating Force | - Loose Piece Part Numbers - | | Dimensions | | | |
|------------------------|-----------------|--------------|------------------------------|--------|------------|------|--------|-----|
| | | | | | - A - | | - B - | |
| | | | | | inches | mm | inches | mm |
| Minimum Quantity | | | 1,000 | 100 | | | | |
| 4 | 25 | Low | 1339G4-BK | 1339G4 | 0.28 | 7.11 | 0.35 | 9.0 |
| 6 | 16 | High | 1339G1-BK | 1339G1 | 0.22 | 5.59 | 0.29 | 7.3 |

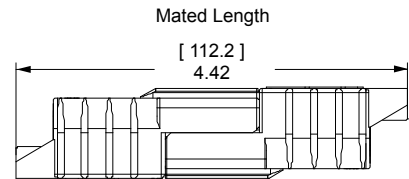
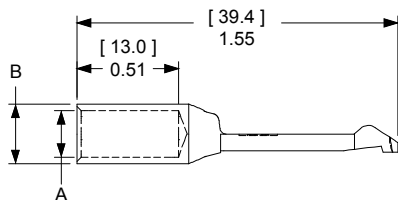

Side View

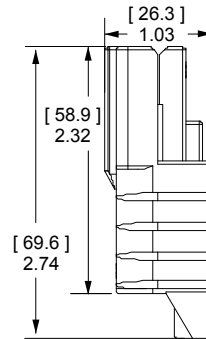

Top View

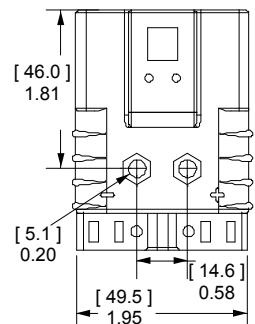

| SBE®80 / SBO®60 CONNECTOR SPECIFICATIONS |

Electrical

| Current Rating Amperes ¹ | SBO60 | SBE80 |
|---|---------|------------------|
| Primary Power (6 AWG) | 70 | 80 |
| Powerpole® Auxiliary (12 AWG) | 20 | 20 |
| 1x4 Auxiliary (12 AWG) | 20 | 20 |
| PPMX Auxiliary (20 AWG) | 7 UL | 5 CSA |
| Voltage Rating AC/DC | UL 1977 | EN1175-1 |
| Primary Power | 600 | 150 ⁴ |
| Powerpole® Auxiliary | 600 | 150 ⁴ |
| 1x4 Auxiliary | 200 | |
| PPMX Auxiliary | 300 | |
| Dielectric Withstanding Voltage Primary Power | | |
| Volts AC | 2,200 | |
| Avg. Mated Contact Resistance Milliohms ¹ | | |
| 1 1/4" of #6 AWG wire | 0.200 | |
| Hot Plug Current Rating Amperes - 250 cycles at 120V DC | | |
| Power | 60A | |
| Powerpole® Auxiliary | 30A | |
| 1x4 Auxiliary | 5A | |

Materials

| Housing | |
|-----------------------------------|---------------------------------|
| SBO® and Powerpole® Plastic Resin | Polycarbonate |
| SBE® and 1x4 Auxiliary Housing | Polycarbonate / PBT blend |
| Contact Retention Spring | Stainless Steel |
| Housing Flammability Rating | |
| UL94 | V-0 |
| Power & Powerpole® Contact | |
| | Silver Plated Copper Alloy |
| 1x4 Auxiliary Contacts | |
| Pin | Copper alloy, Au over Ni |
| Socket | BeCu, Au over Ni |
| Socket Body | Copper alloy, Sn bright over Ni |
| Retention Clip | Stainless Steel |
| PPMX Contacts | |
| | Gold Plated Copper Alloy |
| Contact Termination Methods | |
| | Crimp ³ |
| | Hand Solder |

Mechanical

| Wire Size Range | AWG | mm ² |
|---------------------------------------|-------------|-----------------|
| Power Contacts | 16 to 6 | 1.3 to 13.3 |
| Auxiliary Contacts | 24 to 10 | 0.25 to 5.3 |
| Max. Wire Insulation Diameter | in. | mm |
| Power Contacts | 0.440 | 11.200 |
| Powerpole® Auxiliary | 0.175 | 4.450 |
| 1x4 Auxiliary | 0.140 | 3.600 |
| Operating Temperature ² | °F | °C |
| SBO® and SBE® Housings | -4° to 221° | -20° to 105° |
| Mating Cycles No Load by Plating | Silver (Ag) | Gold (Au) |
| Power Contacts | 10,000 | |
| Powerpole® Auxiliary | 10,000 | |
| 1x4 Auxiliary | | 10,000 |
| PPMX Auxiliary | | 5,000 |
| Avg. Mating / Unmating Force | Lbf. | N |
| Main Connector Housing | 16 | 70 |
| Per Powerpole® | 5 | 22 |
| Per Contact in 1x4 Auxiliary | 0.7 | 3.0 |
| Per PPMX Housing | 4.50 | 20.00 |
| Min. Contact / Spring Retention Force | Lbf. | N |
| Power Standard Housing | 50 | 222 |
| Powerpole® Housing | 25 | 111 |
| 1x4 Auxiliary Housing | 10 | 44.5 |
| PPMX Housing | 12 | 53 |

Protection

| Touch Safety Main Connector Housing | |
|-------------------------------------|------|
| IEC 60950 | Pass |
| IEC 60529 | IP20 |

¹ Based on: 105°C rated or better cable of the largest size, Properly calibrated APP® recommended tooling, and a 25°C ambient temperature. UL rating not to exceed the maximum operating temperature. CSA rating below a 30°C temperature rise.

² Limited by the thermal properties of the connector plastic housing.

³ Use APP® recommended tooling only. Alternate tools may adversely affect the performance of our connectors along with UL and CSA recognition.

⁴ Voltage capability of SBE® housings is identical to SBO®, but derated to meet EN1175-1 requirements.



| SBE®80 / SBO®60 CONNECTOR TEMPERATURE CHARTS |

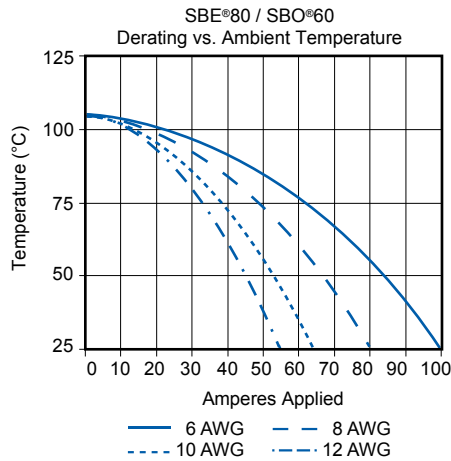
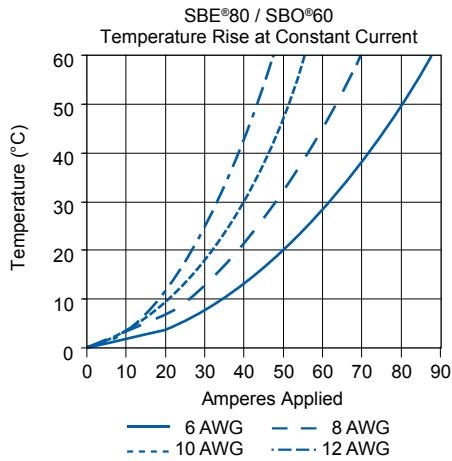

NOTE: Temperature rise charts are based on a 25°C ambient temperature.

| SBE®80 / SBO®60 Accessories |

Cable Clamps

Clamps are made out the same chemical resistant PBT material that is used in the SBE® housings. Clamp holds the cable between the clamp piece and the connector housing. Screws must be ordered separately for part numbers starting with "113".

| Description | Part Numbers | |
|----------------------------|-----------------------|----------------------------|
| Minimum Quantity | 100 | 25 |
| Red Clamp and Hardware Kit | - | SBE80CLPRED or SBO60CLPRED |
| Red Clamp Only | 113953P1 | - |
| Screws (2 per clamp) | H1120P42 (Individual) | - |

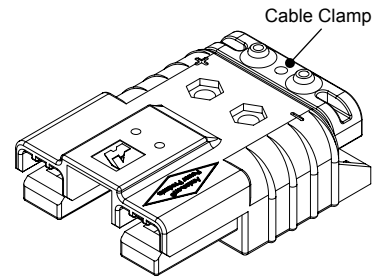

"T" Handle

Handles are made out the same chemical resistant PBT material that is used in the SBE® housings. (2) screws and (2) nuts are required to attach each handle.

| Description | Part Numbers | | |
|-----------------------------|--------------|----------|----------------------------|
| Minimum Quantity | 500 | 100 | 25 |
| Red Handle and Hardware Kit | - | - | SBE80HDLRED or SBO60HDLRED |
| Red Handle Only | 113952P1 | - | - |
| Hardware Bag | - | - | 105G13 |
| M5 x 35mm Screws | - | 113715P4 | - |
| M5 Nut | - | 113716P3 | - |

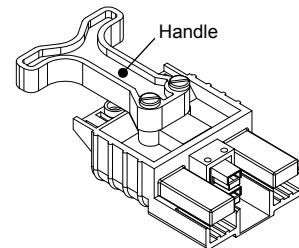

Powerpole® Auxiliary

Powerpole® auxiliary connectors are rated up to 30 amps 600 volts and can be used for auxiliary power, control or sensing. The auxiliary kit includes (1) each black and red Standard Powerpole® housing, (2) contacts, (2) zip cable straps, and (2) retaining pins.

| Description | Part Numbers | | |
|--------------------------|--------------|----------|--------|
| Minimum Quantity | 200 | 100 | 25 ... |
| Powerpole® Auxiliary Kit | - | 111822G1 | 6344 |
| Black Powerpole® Housing | 1327G6 | - | - |
| Red Powerpole® Housing | 1327 | - | - |
| #16 to #12 Contact | 1331 | - | - |
| Retaining Pin | - | 110G9 | - |

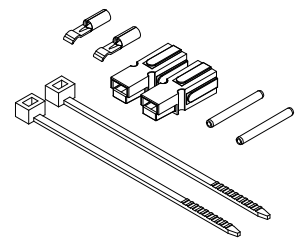

1x4 Auxiliary Connector

APP's unique 1x4 auxiliary connector allows up to 4 auxiliary circuits up to 20 amps 200 volts each in SBE®, SBO®, & SBX® housings. The genderless design holds two each of the gold plated pin & socket contacts. This innovation allows the very durable and cost effective design of SBE®, O, X connectors to substitute for DIN 43589-1 applications where 4 auxiliary contacts are required. Multiple pin lengths allow the further benefit of sequencing between circuits.

(2) Retaining pins are required to hold the auxiliary housing in place. Auxiliary Kits include (1) Auxiliary Housing, (2) Standard Length Pin Contacts, and (2) Socket Contacts, (2) Retaining Pins and (1) Retaining Clip.

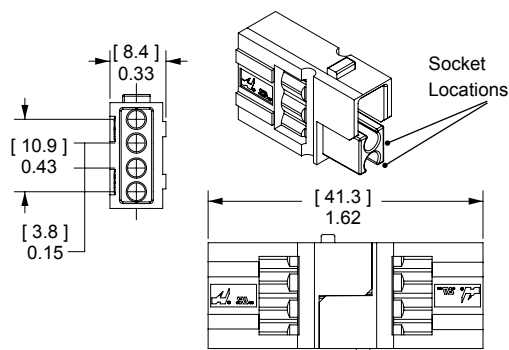

| Description | AWG | mm ² | ----- Part Numbers ----- | | |
|-----------------------|--------------------------|-----------------|--------------------------|-------|--------|
| Minimum Quantity | | | 1,000 | 250 | 25 ... |
| 1x4 Auxiliary Kit | 12 | 4 | - | - | 441G1 |
| 1x4 Auxiliary Kit | 16 to 14 | 1.5 to 2.5 | - | - | 441G2 |
| 1x4 Auxiliary Kit | 20 to 16 | 0.5 to 1.5 | - | - | 441G3 |
| 1x4 Auxiliary Housing | Contacts Sold Separately | | 3-5956P1 | 444G1 | - |

Pin Contacts for 1x4 Auxiliary Connector

Gold plated contacts are available in 4 lengths to allow sequencing of circuits.

| Description | AWG | mm ² | ----- Part Numbers ----- | |
|-----------------------|----------|-----------------|--------------------------|-----------------|
| Minimum Quantity | | | 500 | 50 |
| Standard Length 7.7mm | 12 | 2.5 | PM16P12S30 | PM16P12S30-50 |
| | 16 to 14 | 1.0 to 1.5 | PM16P1416S30 | PM16P1416S30-50 |
| | 20 to 16 | 0.75 to 1.0 | PM16P1620S30 | PM16P1620S30-50 |
| | 24 to 20 | 0.50 to 0.75 | PM16P2024S30 | PM16P2024S30-50 |
| Pre-Mate 9.3mm | 12 | 2.5 | PM16P12A30 | PM16P12A30-50 |
| | 16 to 14 | 1.0 to 1.5 | PM16P1416A30 | PM16P1416A30-50 |
| | 20 to 16 | 0.75 to 1.0 | PM16P1620A30 | PM16P1620A30-50 |
| | 24 to 20 | 0.50 to 0.75 | PM16P2024A30 | PM16P2024A30-50 |
| Pre-Mate 8.5mm | 12 | 2.5 | PM16P12B30 | PM16P12B30-50 |
| | 16 to 14 | 1.0 to 1.5 | PM16P1416B30 | PM16P1416B30-50 |
| | 20 to 16 | 0.75 to 1.0 | PM16P1620B30 | PM16P1620B30-50 |
| | 24 to 20 | 0.50 to 0.75 | PM16P2024B30 | PM16P2024B30-50 |
| Post-Mate 6.4mm | 12 | 2.5 | PM16P12C30 | PM16P12C30-50 |
| | 16 to 14 | 1.0 to 1.5 | PM16P1416C30 | PM16P1416C30-50 |
| | 20 to 16 | 0.75 to 1.0 | PM16P1620C30 | PM16P1620C30-50 |
| | 24 to 20 | 0.50 to 0.75 | PM16P2024C30 | PM16P2024C30-50 |

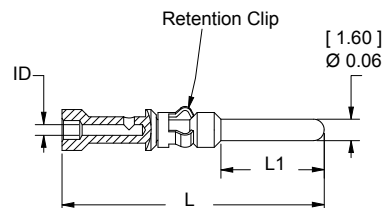

| Auxiliary Pin Contact Lengths | - L - | | - L1 - | |
|-------------------------------|-------|------|--------|-----|
| | in. | mm | in. | mm |
| Standard Length 7.7mm | 0.77 | 19.6 | 0.30 | 7.7 |
| Pre-Mate 9.3mm | 0.83 | 21.2 | 0.37 | 9.3 |
| Pre-mate 8.5mm | 0.80 | 20.4 | 0.33 | 8.5 |
| Post-Mate 6.6mm | 0.72 | 18.3 | 0.25 | 6.4 |

Socket Contacts for 1x4 Auxiliary Connector

Selectively gold plated contacts offer low resistance and durability up to 10,000 mating cycles.

| Description | AWG | mm ² | ----- Part Numbers ----- | |
|------------------|----------|-----------------|--------------------------|-----------------|
| Minimum Quantity | | | 500 | 50 |
| Socket Contact | 12 | 2.5 | PM16S12S32 | PM16S12S32-50 |
| | 16 to 14 | 1.0 to 1.5 | PM16S1416S32 | PM16S1416S32-50 |
| | 20 to 16 | 0.75 to 1.0 | PM16S1620S32 | PM16S1620S32-50 |
| | 24 to 20 | 0.50 to 0.75 | PM16S2024S32 | PM16S2024S32-50 |

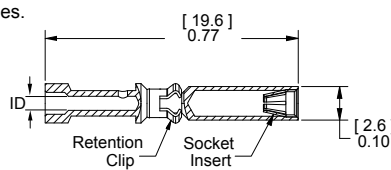

| Auxiliary Socket Contacts Crimp Barrel ID | | |
|---|------|-----|
| Wire Gauge | in. | mm. |
| #24 / 20 | 0.04 | 1.1 |
| #20 / 16 | 0.07 | 1.7 |
| #16 / 14 | 0.08 | 2.1 |
| #12 | 0.10 | 2.6 |

PPMX Auxiliary Connector

The PPMX auxiliary connector allows up to 8 auxiliary circuits to be used in the SBE®, SBO®, & SBX® housings. There are 4 auxiliary circuits per PPMX connector and two PPMX housings fit into the auxiliary port in the main connector housing. Rated up to 7 amps 300 volts per contact, the genderless design holds two each gold plated pin & socket contacts. This innovation allows the very durable and cost effective equipment design of SBE®, O, X connectors to be used for applications requiring up to 8 battery monitoring or vehicle communication circuits. (2) Retaining pins or (1) Retaining clip is required to hold the auxiliary housing in place.

Auxiliary Kits include (1) Auxiliary Housing, (2) Pin Contacts, and (2) Socket Contacts.

| Description | AWG | mm ² | ----- Part Numbers ----- | | |
|-----------------------|--------------------------|-----------------|--------------------------|--------|--------|
| Minimum Quantity | | | 1,000 | 100 | 25 |
| PPMX Auxiliary Kit | 24 to 20 | 0.50 to 0.25 | - | 4850G6 | - |
| 1x4 Auxiliary Housing | Contacts Sold Separately | | 4827G6-BK | - | 4827G6 |

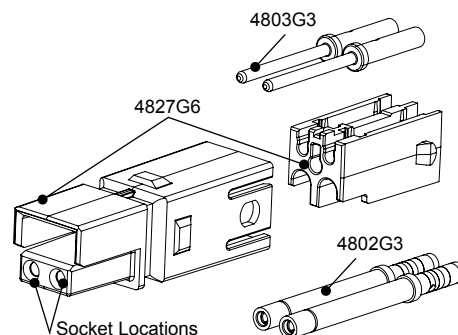

Pin & Socket Contacts for PPMX Auxiliary Connector

Gold plated contacts are ideal for signal or low power use with durability up to 5,000 mating cycles.

| Description | AWG | mm ² | ----- Part Numbers ----- | |
|------------------|----------|-----------------|--------------------------|--------|
| Minimum Quantity | | | 2,000 | 50 |
| Pin Contacts | 24 to 20 | 0.50 to 0.25 | 4803G3-BK | 4803G3 |
| Socket Contacts | 24 to 20 | 0.50 to 0.25 | 4802G3-BK | 4802G3 |

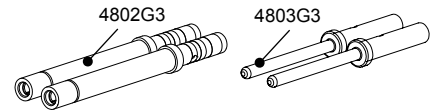

NOTE: Contacts sold individually, not sold as a set of two.

SBE® Air Tubes

Air tubes fit into SBE® housings to allow electrolyte circulation while charging the battery. Genderless tube design allows the same part to be used on both sides. (2) Retaining pins are required to hold the air tube in place. Retaining pins are included in Air Tube Kit.

| Description | ----- Part Numbers ----- | |
|---------------------|--------------------------|--------|
| Minimum Quantity | 500 | 25 |
| Air Tube Kit, Black | - | 6396G1 |
| Air Tube Only | 3-5798P1 | - |

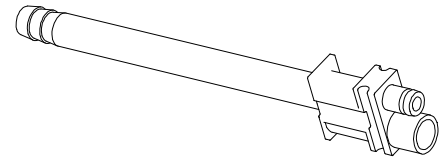

Retaining Pins

Retaining pins are used to hold accessories in the auxiliary port in SBE®, SBO®, & SBX® housings. Dimension "B" is +/- 0.015 in or 0.38 mm.

| Description | --- Part Numbers --- | | Dimensions | | | |
|---------------------|----------------------|-------|---------------|-------------|--------|--------|
| | 1,000 | 100 | - A - | | - B - | |
| | | | inches | mm | inches | mm |
| Minimum Quantity | 1,000 | 100 | | | | |
| For SBE®80 & SBO®60 | 110G9-BK | 110G9 | 0.093 / 0.103 | 2.36 / 2.62 | 1.000 | 38.100 |

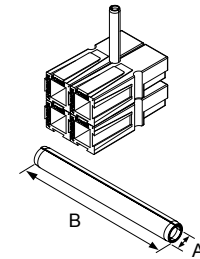

Zip Cable Straps

Zip cable straps are used to secure auxiliary wires to the side of the main power cables.

| Description | -- Part Number -- |
|------------------|-------------------|
| Minimum Quantity | 1,000 |
| White | H1835P3 |

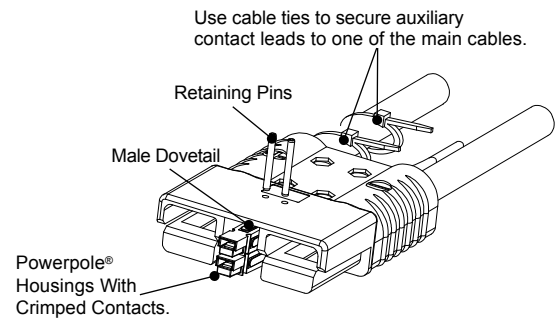

Reducing Bushings

Use with contact part number 1339G1 to allow a smaller wire to be used with the connector. Electrical capability is derated with smaller wire.

| Contact Barrel Size | Wire Size | ----- Part Numbers ----- | | | Dimensions | | | |
|--------------------------------|---|--------------------------|---------|------|------------|------|------------|-------|
| | | 3,000 | 1,000 | 100 | - ID - | | - Length - | |
| | | | | | inches | mm | Inches | mm |
| Minimum Quantity | | 3,000 | 1,000 | 100 | | | | |
| #6 AWG [13.3 mm ²] | #8 AWG [8.4 mm ²] | - | 5912-BK | 5912 | 0.18 | 4.57 | 0.45 | 11.43 |
| #6 AWG [13.3 mm ²] | #12- 10 AWG [3.3- 5.3 mm ²] | 5910-BK | - | 5910 | 0.14 | 3.56 | 0.47 | 11.94 |
| #6 AWG [13.3 mm ²] | #16- 14 AWG [1.3- 2.1 mm ²] | 5913-BK | - | 5913 | 0.09 | 2.29 | 0.47 | 11.94 |

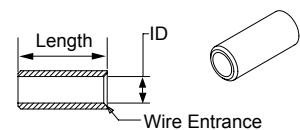

SBO® / SBE® / SBX®

- Tooling Information

| Wire Size | | Loose Piece Part Numbers | Loose Piece Contact Crimp Tool | | | | |
|--|-------------|--------------------------|--------------------------------|---------|-----------|------------------|---------------------|
| AWG | mm² | Contacts | Pneumatic Bench Tool | + Die | + Locator | Number of Crimps | or Hand Tool |
| SBE 320 / SBX 350 | | | | | | | |
| 300 MCM | 152 | 6358 | N/A | N/A | N/A | N/A | 1368 |
| 4/0 AWG | 107.2 | 6356 | 1387G2 | 1303G12 | 1304G28 | Double | |
| 3/0 AWG | 85 | 6355 | | | | | |
| 2/0 AWG | 67.4 | 6354 | | | | | |
| N/A | 95 mm² | 1341G3 | 1387G2 | 1303G17 | 1304G35 | Double | |
| N/A | 70 mm² | 1341G2 | | 1303G12 | 1304G34 | | |
| N/A | 50 mm² | 1341G1 | | 1303G8 | 1304G36 | | |
| SBE 160 / SBX 175 | | | | | | | |
| 1/0 AWG | 53.5 | 6384G1 | 1387G2 | 1303G2 | 1304G2 | Single | 1368 |
| #2 | 35 mm² | 6384G2 | 1387G1 | 1388G3 | 1389G3 | | |
| | | | 1387G2 | 1303G2 | 1304G2 | | |
| SBO 60 / SBE 80 | | | | | | | |
| #4 | 25 | 1339G4 | 1387G1 | 1388G7 | 1389G9 | Single | N/A |
| #6 | 16 | 1339G1 | | 1388G6 | | | 1309G4 |
| Powerpole 15/45 Auxiliary Contacts ** | | | | | | | |
| #16 / 20 | 1.3 / .52 | 1332 | 1367G1 | N/A | N/A | Single | 1309G2 or 1309G8 |
| #12 / 16 | 3.3 / 1.3 | 1331 | | | | | |
| PowerMod 1x4 Auxiliary Contacts | | | | | | | |
| #12 / 24 | 2.5 / .25 | All Crimp Pins | TP0001* | N/A | TL0001 | Single | TM0001* |
| | | All Crimp Sockets | | | TL0002 | | PM1000G1 |
| PPMX Auxiliary Contacts | | | | | | | |
| #20 / 24 | 0.50 / 0.25 | 4803G3 | TP0001* | N/A | TL0005 | Single | TM0001* or |
| | | 4802G3 | | | | | PM1000G1 |

* TP0001 and TM0001 tools require locators to properly position contacts.

** See Powerpole® family tooling chart for other Powerpole® contacts

NOTE: See website for the most current information.