

CONTINUOUS HINGE, TYPE 4X

INDUSTRY STANDARDS

Mounting brackets required to meet UL/CSA external mounting requirements.

UL 508A Listed; Type 4, 4X, 12, 13; File No. E61997
 cUL Listed per CSA C22.2 No 94; Type 4, 4X, 12, 13; File No. E61997
 Enclosure flammability evaluated per UL 508A
 Window flammability evaluated per UL 508A

NEMA/EEMAC Type 4, 4X, 12, 13
 CSA File No. 42186: Type 4, 4X, 12, 13
 IEC 60529, IP66

APPLICATION

The efficient design and simple construction of these enclosures make them durable in corrosive environments, yet aesthetically pleasing. Corner latches provide unobstructed access. The continuous hinge provides a secure seal, and double latching creates added security.

SPECIFICATIONS

- Compression-molded fiberglass has outstanding chemical- and temperature-resistance qualities and exhibits excellent weatherability and physical properties
- Fiberglass is easily punched, drilled, filed or sawed
- Gasket assures water-tight and dust-tight seal
- Polyester mounting brackets and stainless steel attachment screws are provided with each enclosure
- Scratch-resistant polycarbonate windows are permanently bonded in place
- Molded-in-place threaded brass inserts and plated steel screws are provided for mounting optional panels and terminal block kits
- Removable hinged cover attached to body with Type 316 stainless steel hinge pin
- Screw-cover enclosures are secured with two captivated Type 316 stainless steel slotted cover screws
- Enclosures with quick-release latches have corrosion-resistant polyester latches located in corners that provide unobstructed access to enclosure
- Hinge pin and bail are corrosion-resistant Type 316 stainless steel
- Padlock provisions included in each latch

FINISH

Fiberglass material is light-gray inside and out. Optional steel panels are painted white. Optional stainless steel, aluminum, conductive and composite panels are unpainted.

ACCESSORIES

See also *Accessories*.

- H2OMIT™ Vent Drains, Type 4X
- HOL-SEALERS™ Non-Metallic Hole Seals
- Panels for Junction Boxes
- Threaded Panel Extenders
- Quick-Release Latch Kit
- Swing-Out Panel Kit

MODIFICATION AND CUSTOMIZATION

Hoffman excels at modifying and customizing products to your specifications. Contact your local Hoffman sales office or distributor for complete information.

BULLETIN: A48

Standard Product **Solid Cover**

Catalog Number	AxBxC in./mm	Type	Steel Panel	Alum. Panel	Panel Size D x E in./mm	Mounting G x H in./mm	Overall L x W in./mm	F in./mm	J in./mm	K in./mm	O in./mm	P in./mm	Q in./mm	T in./mm	U in./mm
A664CHSCFG	6.00 x 6.00 x 4.00 152 x 152 x 102	Screw Cover	A6P6	A6P6AL	4.88 x 4.88 124 x 124	6.94 x 4.00 176 x 102	6.50 x 6.50 165 x 165	3.45 88	3.25 83	1.00 25	4.25 108	4.25 108	5.64 143	0.12 3	5.64 143
A664CHQRFG	6.00 x 6.00 x 4.00 152 x 152 x 102	Quick Release	A6P6	A6P6AL	4.88 x 4.88 124 x 124	6.94 x 4.00 176 x 102	6.50 x 6.50 165 x 165	3.45 88	3.25 83	1.00 25	4.25 108	4.25 108	5.64 143	0.12 3	5.64 143
A864CHSCFG	8.00 x 6.00 x 4.00 203 x 152 x 102	Screw Cover	A8P6	A8P6AL	6.75 x 4.88 171 x 124	8.94 x 4.00 227 x 102	8.50 x 6.50 216 x 165	3.45 88	3.25 83	1.00 25	4.25 108	6.25 159	7.64 194	0.12 3	5.64 143
A864CHQRFG	8.00 x 6.00 x 4.00 203 x 152 x 102	Quick Release	A8P6	A8P6AL	6.75 x 4.88 171 x 124	8.94 x 4.00 227 x 102	8.50 x 6.50 216 x 165	3.45 88	3.25 83	1.00 25	4.25 108	6.25 159	7.64 194	0.12 3	5.64 143
A1086CHSCFG	10.00 x 8.00 x 6.00 254 x 203 x 152	Screw Cover	A10P8	A10P8AL	8.75 x 6.88 222 x 175	10.94 x 6.00 278 x 152	10.50 x 8.50 267 x 216	5.45 138	4.94 125	1.31 33	6.25 159	8.25 210	9.61 244	0.12 3	7.61 193
A1086CHQRFG	10.00 x 8.00 x 6.00 254 x 203 x 152	Quick Release	A10P8	A10P8AL	8.75 x 6.88 222 x 175	10.94 x 6.00 278 x 152	10.50 x 8.50 267 x 216	5.45 138	4.94 125	1.31 33	6.25 159	8.25 210	9.61 244	0.12 3	7.61 193
A12106CHSCFG	12.00 x 10.00 x 6.00 305 x 254 x 152	Screw Cover	A12P10	A12P10AL	10.75 x 8.88 273 x 226	12.94 x 8.00 329 x 203	12.50 x 10.50 318 x 267	5.45 138	4.69 119	1.56 40	8.25 210	10.25 260	11.58 294	0.12 3	9.58 243
A12106CHQRFG	12.00 x 10.00 x 6.00 305 x 254 x 152	Quick Release	A12P10	A12P10AL	10.75 x 8.88 273 x 226	12.94 x 8.00 329 x 203	12.50 x 10.50 318 x 267	5.45 138	4.69 119	1.56 40	8.25 210	10.25 260	11.58 294	0.12 3	9.58 243
A14128CHSCFG	14.00 x 12.00 x 8.00 356 x 305 x 203	Screw Cover	A14P12	A14P12AL	12.75 x 10.88 324 x 276	14.94 x 10.00 379 x 254	14.55 x 12.55 370 x 319	7.45 189	6.50 165	1.81 46	10.25 260	12.25 311	13.59 345	0.15 4	11.59 294
A14128CHQRFG	14.00 x 12.00 x 8.00 356 x 305 x 203	Quick Release	A14P12	A14P12AL	12.75 x 10.88 324 x 276	14.94 x 10.00 379 x 254	14.55 x 12.55 370 x 319	7.45 189	6.50 165	1.81 46	10.25 260	12.25 311	13.59 345	0.15 4	11.59 294
A16148CHSCFG	16.00 x 14.00 x 8.00 406 x 356 x 203	Screw Cover	A16P14	A16P14AL	14.75 x 12.88 375 x 327	16.94 x 12.00 430 x 305	16.55 x 14.55 420 x 370	7.45 189	6.23 158	2.08 53	12.25 311	14.25 362	15.56 395	0.15 4	13.56 344
A16148CHQRFG	16.00 x 14.00 x 8.00 406 x 356 x 203	Quick Release	A16P14	A16P14AL	14.75 x 12.88 375 x 327	16.94 x 12.00 430 x 305	16.55 x 14.55 420 x 370	7.45 189	6.23 158	2.08 53	12.25 311	14.25 362	15.56 395	0.15 4	13.56 344
A181610CHSCFG	18.00 x 16.00 x 10.00 457 x 406 x 254	Screw Cover	A18P16	A18P16AL	16.75 x 14.88 425 x 378	18.94 x 14.00 481 x 356	18.58 x 16.58 472 x 421	9.45 240	7.66 195	2.66 68	14.25 362	16.25 413	17.53 445	0.16 4	15.53 394
A181610CHQRFG	18.00 x 16.00 x 10.00 457 x 406 x 254	Quick Release	A18P16	A18P16AL	16.75 x 14.88 425 x 378	18.94 x 14.00 481 x 356	18.58 x 16.58 472 x 421	9.45 240	7.66 195	2.66 68	14.25 362	16.25 413	17.53 445	0.16 4	15.53 394

Purchase panels separately. Optional stainless steel, aluminum, conductive and composite material panels available for most sizes.

Standard Product **Window Cover**

Catalog Number	AxBxC in./mm	Type	Steel Panel	Alum. Panel	Panel Size D x E in./mm	Mounting G x H in./mm	Overall L x W in./mm	F in./mm	J in./mm	K in./mm	M in./mm	N in./mm	O in./mm	P in./mm	Q in./mm	T in./mm	U in./mm
A664CHSCFGW	6.00 x 6.00 x 4.00 152 x 152 x 102	Screw Cover	A6P6	A6P6AL	4.88 x 4.88 124 x 124	6.94 x 4.00 176 x 102	6.50 x 6.50 165 x 165	3.45 88	3.25 83	1.00 25	4.25 108	4.25 108	4.25 108	4.25 108	5.64 143	0.12 3	5.64 143
A664CHQRFGW	6.00 x 6.00 x 4.00 152 x 152 x 102	Quick Release	A6P6	A6P6AL	4.88 x 4.88 124 x 124	6.94 x 4.00 176 x 102	6.50 x 6.50 165 x 165	3.45 88	3.25 83	1.00 25	4.25 108	4.25 108	4.25 108	4.25 108	5.64 143	0.12 3	5.64 143
A864CHSCFGW	8.00 x 6.00 x 4.00 203 x 152 x 102	Screw Cover	A8P6	A8P6AL	6.75 x 4.88 171 x 124	8.94 x 4.00 227 x 102	8.50 x 6.50 216 x 165	3.45 88	3.25 83	1.00 25	6.25 159	4.25 108	4.25 108	6.25 159	7.64 194	0.12 3	5.64 143
A864CHQRFGW	8.00 x 6.00 x 4.00 203 x 152 x 102	Quick Release	A8P6	A8P6AL	6.75 x 4.88 171 x 124	8.94 x 4.00 227 x 102	8.50 x 6.50 216 x 165	3.45 88	3.25 83	1.00 25	6.25 159	4.25 108	4.25 108	6.25 159	7.64 194	0.12 3	5.64 143
A1086CHSCFGW	10.00 x 8.00 x 6.00 254 x 203 x 152	Screw Cover	A10P8	A10P8AL	8.75 x 6.88 222 x 175	10.94 x 6.00 278 x 152	10.50 x 8.50 267 x 216	5.45 138	4.94 125	1.31 33	8.25 210	6.25 159	6.25 159	8.25 210	9.61 244	0.12 3	7.61 193
A1086CHQRFGW	10.00 x 8.00 x 6.00 254 x 203 x 152	Quick Release	A10P8	A10P8AL	8.75 x 6.88 222 x 175	10.94 x 6.00 278 x 152	10.50 x 8.50 267 x 216	5.45 138	4.94 125	1.31 33	8.25 210	6.25 159	6.25 159	8.25 210	9.61 244	0.12 3	7.61 193
A12106CHSCFGW	12.00 x 10.00 x 6.00 305 x 254 x 152	Screw Cover	A12P10	A12P10AL	10.75 x 8.88 273 x 226	12.94 x 8.00 329 x 203	12.50 x 10.50 318 x 267	5.45 138	4.69 119	1.56 40	10.25 260	8.25 210	8.25 210	10.25 260	11.58 294	0.12 3	9.58 243
A12106CHQRFGW	12.00 x 10.00 x 6.00 305 x 254 x 152	Quick Release	A12P10	A12P10AL	10.75 x 8.88 273 x 226	12.94 x 8.00 329 x 203	12.50 x 10.50 318 x 267	5.45 138	4.69 119	1.56 40	10.25 260	8.25 210	8.25 210	10.25 260	11.58 294	0.12 3	9.58 243
A14128CHSCFGW	14.00 x 12.00 x 8.00 356 x 305 x 203	Screw Cover	A14P12	A14P12AL	12.75 x 10.88 324 x 276	14.94 x 10.00 379 x 254	14.55 x 12.55 370 x 319	7.45 189	6.50 165	1.81 46	12.25 311	10.25 260	10.25 260	12.25 311	13.59 345	0.15 4	11.59 294
A14128CHQRFGW	14.00 x 12.00 x 8.00 356 x 305 x 203	Quick Release	A14P12	A14P12AL	12.75 x 10.88 324 x 276	14.94 x 10.00 379 x 254	14.55 x 12.55 370 x 319	7.45 189	6.50 165	1.81 46	12.25 311	10.25 260	10.25 260	12.25 311	13.59 345	0.15 4	11.59 294
A16148CHSCFGW	16.00 x 14.00 x 8.00 406 x 356 x 203	Screw Cover	A16P14	A16P14AL	14.75 x 12.88 375 x 327	16.94 x 12.00 430 x 305	16.55 x 14.55 420 x 370	7.45 189	6.23 158	2.08 53	14.25 362	12.25 311	12.25 311	14.25 362	15.56 395	0.15 4	13.56 344
A16148CHQRFGW	16.00 x 14.00 x 8.00 406 x 356 x 203	Quick Release	A16P14	A16P14AL	14.75 x 12.88 375 x 327	16.94 x 12.00 430 x 305	16.55 x 14.55 420 x 370	7.45 189	6.23 158	2.08 53	14.25 362	12.25 311	12.25 311	14.25 362	15.56 395	0.15 4	13.56 344
A181610CHSCFGW	18.00 x 16.00 x 10.00 457 x 406 x 254	Screw Cover	A18P16	A18P16AL	16.75 x 14.88 425 x 378	18.94 x 14.00 481 x 356	18.58 x 16.58 472 x 421	9.45 240	7.66 195	2.66 68	16.25 413	14.25 362	14.25 362	16.25 413	17.53 445	0.16 4	15.53 394
A181610CHQRFGW	18.00 x 16.00 x 10.00 457 x 406 x 254	Quick Release	A18P16	A18P16AL	16.75 x 14.88 425 x 378	18.94 x 14.00 481 x 356	18.58 x 16.58 472 x 421	9.45 240	7.66 195	2.66 68	16.25 413	14.25 362	14.25 362	16.25 413	17.53 445	0.16 4	15.53 394

Purchase panels separately. Optional stainless steel, aluminum, conductive and composite material panels available for most sizes.

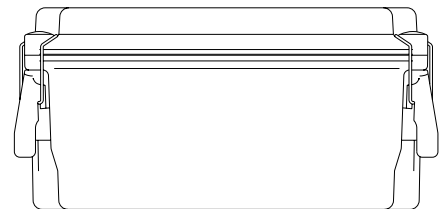
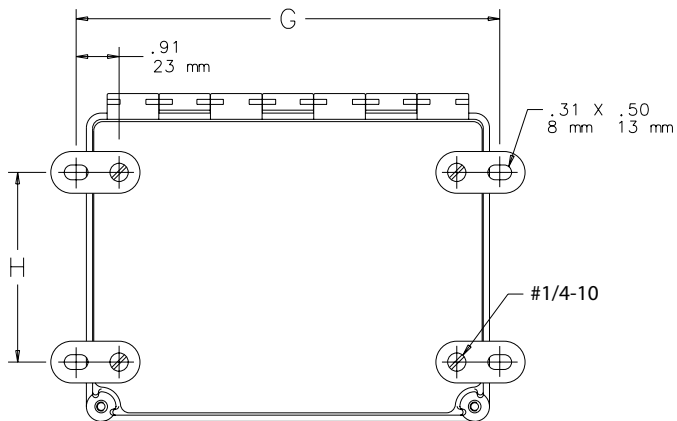
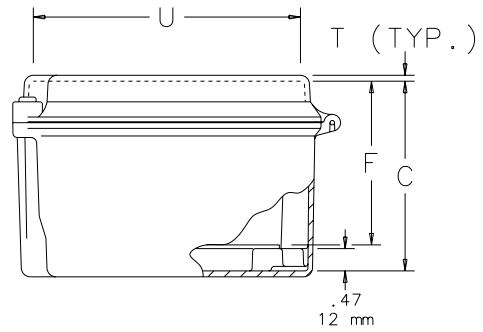
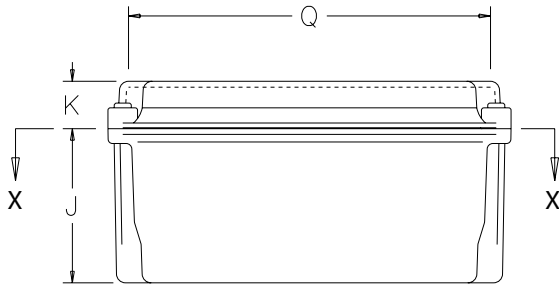
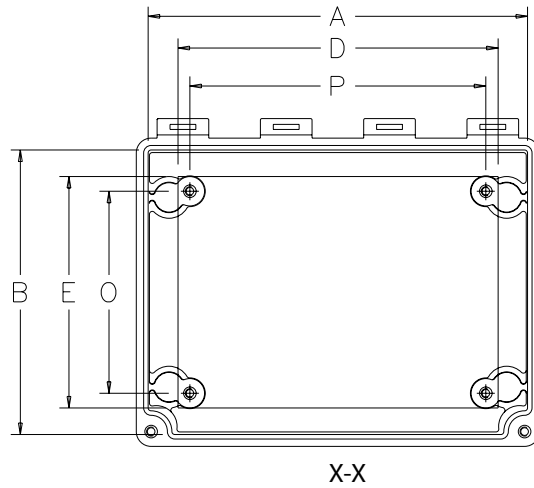
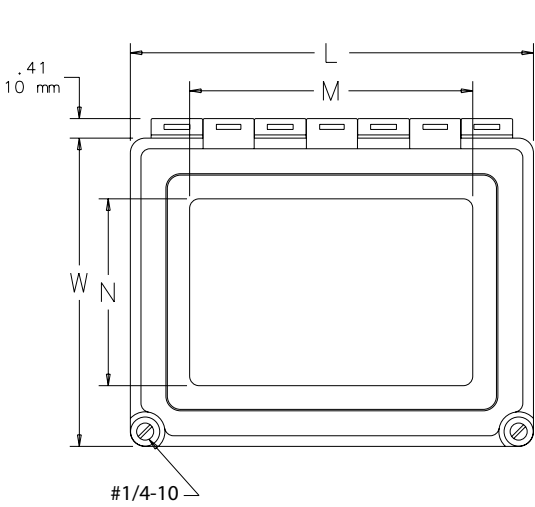

SIDE VIEW
(QUICK-RELEASE COVER ENCLOSURE)

C2567-C

QUICK-RELEASE LATCH KIT



Two fiberglass-reinforced gray polyester latches with 316L stainless steel bail and screw-hole plugs are included in each package. Supplied with Continuous Hinge, Type 4X enclosures and available for Fiberglass Hinged Cover WiFi Cabinet, Type 4X. Kit converts screw-cover enclosures to quick-release without modification. No tools needed to install. Padlocking provision is included.

BULLETIN: A48Y

Catalog Number	Description	Kit Qty.
AL48	Quick-Release Latch Kit	2

SWING-OUT PANEL KIT



The Swing-Out Panel Kit provides an attractive, cost-effective solution for installing front-mounted panels in Continuous Hinge, Type 4X, and Overlapping Cover, Type 4X enclosures. No drilling required.

BULLETIN: A48Y

Catalog Number	Fits Enclosure	
	A x B (in.)	A x B (mm)
A6SPK6C	6.00 x 6.00	152 x 152
A8SPK6C	8.00 x 6.00	203 x 152
A10SPK8C	10.00 x 8.00	254 x 203
A12SPK10C	12.00 x 10.00	305 x 254
A16SPK14C	16.00 x 14.00	406 x 356
A18SPK16C	18.00 x 16.00	457 x 406
A14SPK12C	14.00 x 12.00	356 x 305