



Weller[®]
Get the Advantage



*Acuna Tools Corp
3100 NW 72 AVE
Suite 103
Miami, FL 33122*

*Tel: (305) 592-4438
Judy@acunatools.com*



THE WELLER ADVANTAGE

Weller, the name synonymous with rework technology innovation, is once again leading the way with application solutions to your most complex electronics manufacturing challenges...

- Our tip fume extraction and volume fume extraction systems are perfect examples of Weller responding to current industry trends and anticipating the future direction of occupational safety and health awareness.
- Systems centered on our WP120 soldering pencil offer the increased power needed for the latest high-mass PCBs.
- Innovative Weller engineering has extended tip life, offering savings to manufacturers striving to win in today's more competitive marketplace.
- Weller investments in battery soldering technology have yielded cordless, portable products that offer impressive performance with equally impressive battery life.



Your Weller sales representative can help you increase productivity, reduce costs, and improve safety. And all Weller representatives are supported by a staff of highly experienced technical experts who can analyze your soldering applications and offer a system solution that will not only answer the current challenge, but address future ones. Find out more. Contact Weller at www.apextoolgroup.com.



C O N T E N T S

4
Soldering Stations

26
Rework Stations

34
Hot Air Stations

44
Fume Extraction

61
Soldering Irons

66
Cordless Soldering Irons

69
Heat Guns

70
Soldering Guns

71
Accessories

76
Dispensing

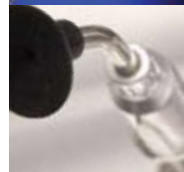
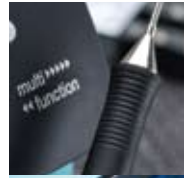

WD1002

DIGITAL SILVER SERIES SOLDERING STATION

THE WELLER ADVANTAGE:

Another Weller breakthrough gives you two pencils in one. This powerful 80-watt pencil allows rapid production when working with lead-free solder, high mass components, and other demanding applications. A special silver heating element for low thermal loss and fast recovery make this unit ideal for continuous production work. The interchangeable barrel gives you the option of working with either a traditional length or shorter tip-to-grip.



FEATURES AND BENEFITS:

- Modern LCD technology gives the user critical information at a glance
- Three freely programmable temperature preset buttons allow quick and easy temperature changes
- Powerful 80-watt pencil allows rapid production when working with lead-free solder, high-mass components, and other demanding applications

The following functions are built in to the WD1 power unit:

- Setback time: Allows programming of the number of minutes (1 – 99), before temperature sets back to idle mode.
- Standby temperature: Allows selection of desired setback temperature, down to 200°F.
- Temperature lockout: Allows supervisor to easily set a temperature that cannot be changed by the operator.
- °F/°C switching: Allows the temperature display to read in either °F or °C.
- Temperature offset: Allows the display temperature to be adjusted +/- 72°F when working with higher mass tips, where the temperature reading can be affected by the mass of the tip.
- Auto-Off Time: Allows programming the number of minutes of inactivity (1 – 999), before the station powers off automatically.
- WD1002 complete with WD1 power supply, WP80 iron, LTB tip, WDH10 stand, and WDC2 dry cleaner 0051512599.
- Optional longer barrel part number 0058744846.

The Silver Spool heating element provides low thermal loss and fast recovery

Optional longer barrel available
Part # 0058744846



WDH10T Stop & Go stand.

WD1002T

SAME AS ABOVE WITH WDH10T STOP & GO STAND



See page 9 for components and specifications
See page 5 for LT series soldering tips



TIPS

**LT SERIES TIPS FOR WSP80 & WP80 SOLDERING PENCILS.
TINNED WITH LEAD FREE SOLDER**

CHISEL	Cat No.	A		B		C	
		IN.	MM	IN.	MM	IN.	MM
	LTA	0.063	1.60	0.028	0.70	0.380	13.50
	LTB	0.094	2.40	0.031	0.79	0.430	13.50
	LTC	0.126	3.20	0.031	0.79	0.430	13.50
	LTD	0.181	4.60	0.031	0.79	0.430	13.50
	LTH	0.031	0.79	0.016	0.40	0.430	13.50
	LTK	0.047	1.20	0.016	0.40	0.730	21.00
	LTL	0.078	2.00	0.039	1.00	0.790	21.00
	LTM	0.126	3.20	0.047	1.20	0.790	21.00

ROUND	Cat No.	A		C	
		IN.	MM	IN.	MM
	LT1	0.010	0.25	0.430	14.00
	LT1L	0.008	0.20	0.980	26.40
	LT1S	0.008	0.20	0.590	15.00
	LTAS	0.063	1.60	0.380	13.50
	LTCS	0.126	3.20	0.430	13.50
	LTS	0.016	0.40	0.790	21.00
					

BENT CHISEL	Cat No.	A		B		C	
		IN.	MM	IN.	MM	IN.	MM
	LT4X	0.047	1.20	0.016	0.40	0.590	16.50
	LTAX	0.063	1.60	0.032	0.80	0.500	13.50
	LTHX	0.032	0.80	0.016	0.40	0.790	18.00

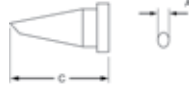
SINGLE FLAT	Cat No.	A		C	
		IN.	MM	IN.	MM
	LTF	0.047	1.20	0.490	13.50

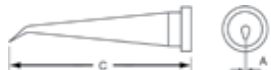
BENT ROUND	Cat No.	A		C	
		IN.	MM	IN.	MM
	LT1LX	0.008	0.20	0.980	26.40
	LT1SLX	0.016	0.40	0.760	20.50
	LT1X	0.016	0.40	0.370	12.50

KNIFE	Cat No.	A		C	
		IN.	MM	IN.	MM
	LTKN	0.080	2.00	0.650	16.50

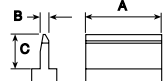
SMT BLADE	Cat No.	A		B		C	
		IN.	MM	IN.	MM	IN.	MM
	0054450199	0.410	10.41	0.024	0.60	0.280	7.11
	0054450299	0.661	16.80	0.024	0.60	0.280	7.11
	0054450399	0.820	20.83	0.024	0.60	0.280	7.11

TIP RETAINERS	Cat No.	Description
	0058744845	Retainer for WP80 Soldering Pencil
	0058744846	Optional Long Reach Retainer for WP80 Soldering Pencil
	0058744710	Tip Retainer Assembly for WSP80 Soldering Pencil



WD1001

DIGITAL SILVER SERIES SOLDERING STATION

THE WELLER ADVANTAGE:

With a tip-to-grip distance of just 37 mm, accuracy is unsurpassed. And with the heating element built into the pencil rather than the tip, replacement tips cost substantially less when compared to systems with tip cartridges.



FEATURES AND BENEFITS:

- Super-fast heat-up and superior thermal recovery for fast efficient soldering
- Three freely programmable temperature preset buttons allow quick and easy temperature changes

The following functions are built in to the WD1 power unit:

- Setback time: Allows programming of the number of minutes (1 – 99), before temperature sets back to idle mode.
- Standby temperature: Allows selection of desired setback temperature, down to 200°F.
- Temperature lockout: Allows supervisor to easily set a temperature that cannot be changed by the operator.
- °F/°C switching: Allows the temperature display to read in either °F or °C.
- Temperature offset: Allows the display temperature to be adjusted +/- 72°F when working with higher mass tips, where the temperature reading can be affected by the mass of the tip.
- Auto-Off Time: Allows programming the number of minutes of inactivity (1 – 999), before the station powers off automatically.
- WD1001 complete with WD1 power supply, WMP 65 Watt Iron, NT1 tip, WDH20 stand, WDC2 dry cleaner 0051512599 and 0058751710 tip removal tool.



Just 37 mm (1.46") tip-to-grip, so you're close to the work.

See page 8 for components and specifications
See page 7 for NT series soldering tips

WD1000HPT

DIGITAL SILVER SERIES SOLDERING STATION

THE WELLER ADVANTAGE:

With 120 watts of power this station is ideal for soldering on difficult circuit boards with high heat sinks. Target applications include high density circuit boards and solar panel production.

FEATURES AND BENEFITS:

- Compact, powerful heating element guarantees dynamic performance
- Rapid transfer of heat into the soldering tip is quickly and precisely controlled with sophisticated electronics allowing the WP120 to cope with big, difficult solder joints
- Three freely programmable temperature preset buttons allow quick and easy temperature changes







WD1000HPT complete with WD1M power supply, WP120 iron, XTB tip and WDH10T Stop & Go stand.

See page 10 for XT series soldering tips

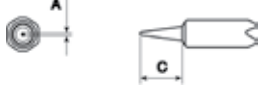

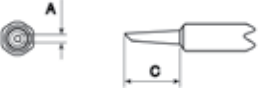
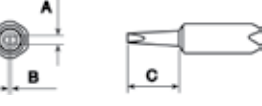
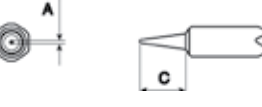
TIPS

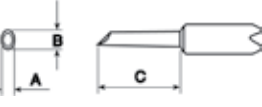
**NT SERIES TIPS FOR WMP MICRO SOLDERING PENCIL.
TINNED WITH LEAD FREE SOLDER**

MICRO		A		C			
Cat No.	IN.	MM	IN.	MM			
	NT1	0.010	0.25	0.291	7.40		
MICRO		A		C			
Cat No.	IN.	MM	IN.	MM			
	NT1S	0.010	0.25	0.333	8.45		
BENT ROUND		A		B		C	
Cat No.	IN.	MM	IN.	MM	IN.	MM	
	NT1X	0.016	0.40	0.063	1.60	0.321	8.15
ROUND		A		C			
Cat No.	IN.	MM	IN.	MM			
	NT4	0.047	1.20	0.390	9.90		
CHISEL		A		B		C	
Cat No.	IN.	MM	IN.	MM	IN.	MM	
	NT6	0.063	1.60	0.016	0.40	0.372	9.45
	NTA	0.063	1.60	0.016	0.40	0.331	8.40
	NTB	0.094	2.40	0.031	0.80	0.289	7.35
	NTC	0.126	3.20	0.031	0.80	0.305	7.75
	NTD	0.157	4.00	0.031	0.80	0.305	7.75
	NTH	0.031	0.80	0.016	0.40	0.331	8.40
	NTK	0.047	1.20	0.016	0.40	0.331	8.40
FINE CHISEL		A		C			
Cat No.	IN.	MM	IN.	MM			
	NT1SC	0.008	0.20	0.291	7.40		
BENT CHISEL		A		B		C	
Cat No.	IN.	MM	IN.	MM	IN.	MM	
	NTAX	0.063	1.60	0.031	0.40	0.339	8.61
GULL WING FOR DRAG SOLDERING		A		B		C	
Cat No.	IN.	MM	IN.	MM	IN.	MM	
	NTGW	0.079	2.00	0.118	3.00	0.528	13.40
TIP REMOVAL TOOL		Cat No.					
		0058751710					



PRODUCT LINE

CONFIGURED TO GIVE YOU THE MOST EFFICIENT SOLUTION



WD1

SINGLE CHANNEL POWER UNIT

Specifications:

Voltage	120 V (input); 24 V (output)
Footprint	5.27" x 4.25" x 5.77" (134 x 108 x 147 mm)
Power consumption	95W
Temperature range	150° F - 850° F (50° C - 450° C)
ESD safe	Yes
Temperature accuracy	± 17° F (± 9° C)
Temperature stability	± 10° F (± 6° C)



WD2

DUAL CHANNEL POWER UNIT

Specifications:

Voltage	120 V (input); 24 V (output)
Footprint	5.27" x 4.25" x 5.77" (134 x 108 x 147 mm)
Power consumption	160W
Temperature range	150° F - 850° F (50° C - 450° C)
ESD safe	Yes
Temperature accuracy	± 17° F (± 9° C)
Temperature stability	± 10° F (± 6° C)



WD1001

WD1 SINGLE CHANNEL POWER UNIT WITH WMP 65 WATT SOLDERING PENCIL AND WDH20 SOLDERING PENCIL STAND

Specifications:

Voltage	120 V (input); 24 V (output)
Footprint	5.27" x 4.25" x 5.77" (134 x 108 x 147 mm)
Power consumption	95W
Temperature range	150° F - 850° F (50° C - 450° C)
ESD safe	Yes
Temperature accuracy	± 17° F (± 9° C)
Temperature stability	± 10° F (± 6° C)
Stand	WDH20 (Order No. 0051512299)
Pencil	WMP
Tip	NT1



WD1002

WD1 SINGLE CHANNEL POWER UNIT WITH WP80 80 WATT SOLDERING PENCIL AND WDH10 SOLDERING PENCIL STAND



Specifications:

Voltage	120 V (input); 24 V (output)
Footprint	5.27" x 4.25" x 5.77" (134 x 108 x 147 mm)
Power consumption	95W
Temperature range	150° F - 850° F (50° C - 450° C)
ESD safe	Yes
Temperature accuracy	± 17° F (± 9° C)
Temperature stability	± 10° F (± 6° C)
Stand	WDH10 (Order No. 0051512199)
Pencil	WP80 (Order No. 0052918099)
Tip	LTB
Barrels	Short (Included with the WP80) (Order No. 0058744845) Long (Optional) (Order No. 0058744846)

WD1002T

WD1 SINGLE CHANNEL POWER UNIT WITH WP80 80 WATT SOLDERING PENCIL AND WDH10T STOP & GO STAND



Specifications:

Voltage	120 V (input); 24 V (output)
Footprint	5.27" x 4.25" x 5.77" (134 x 108 x 147 mm)
Power consumption	95W
Temperature range	150° F - 850° F (50° C - 450° C)
ESD safe	Yes
Temperature accuracy	± 17° F (± 9° C)
Temperature stability	± 10° F (± 6° C)
Stand	WDH10T (Order No. 0051516199)
Pencil	WP80 (Order No. 0052918099)
Tip	LTB
Barrels	Short (Included with the WP80) (Order No. 0058744845) Long (Optional) (Order No. 0058744846)

WD1000HPT

WD1M SINGLE CHANNEL POWER UNIT WITH WP120 HIGH OUTPUT SOLDERING PENCIL AND WDH10T STOP & GO STAND



Specifications:

Voltage	120 V (input); 24 V (output)
Footprint	5.27" x 4.25" x 5.77" (134 x 108 x 147 mm)
Power consumption	160 W
Temperature range	150° F to 850° F (50° C - 450° C)
ESD safe	Yes
Temperature accuracy	± 17° F (± 9° C)
Temperature stability	± 10° F (± 6° C)
Stand	WDH10T (Order No. 0051516199)
Pencil	WP120 (Order No. 0052919399)
Tip	XTB



TIPS

**XT SERIES TIPS FOR THE WP120 SOLDERING PENCIL.
TINNED WITH LEAD FREE SOLDER.**

Tips	Order #	Description
	0054470199	XTAL, .063" x 1.543" / 1.6 mm x 39.2 mm Reach Chisel Tip
	0054470299	XTM, .126" x 1.543" / 3.2 mm x 39.2 mm Reach Chisel Tip
	0054470399	XTA, .063" x 1.420" / 1.6 mm x 36.1 mm Reach Chisel Tip
	0054470499	XTB, .094" x 1.420" / 2.4 mm x 36.1 mm Reach Chisel Tip
	0054470599	XTC, .126" x 1.420" / 3.2 mm x 36.1 mm Reach Chisel Tip
	0054470699	XTD, .181" x 1.360" / 4.6 mm x 34.5 mm Reach Chisel Tip
	0054470799	XTE, .232" x 1.360" / 5.9 mm x 34.5 mm Reach Chisel Tip
	0054470899	XTAA, .063" x 1.437" / 1.6 mm x 36.5 mm Reach, Round Angled Tip
	0054470999	XTBB, .094" x 1.437" / 2.4 mm x 36.5 mm Reach, Round Angled Tip
	0054471099	XTCC, .126" x 1.437" / 3.2 mm x 36.5 mm Reach, Round Angled Tip
	0054471199	XTKN, .079" x 1.772" / 2.0 mm x 45 mm Reach, Knife Tip
	0054471299	XTGW, .090/.126" x 1.437" / 2.0 mm x 45 mm Reach Gull Wing Tip
	0054471399	XTH, .016/.031" x 1.437" 0.4 mm / 0.8 mm x 36.5 mm Reach, Chisel Tip
	0054471499	XTO, .039" x 1.437" / 1.0 mm x 36.5 mm Reach, Long Conical Tip
	0054471599	XTBS, .094" x 1.437" / 2.4 mm x 36.5 mm Reach, Round Tip
	0054471699	XTCS, .126" x 1.437" / 3.2 mm x 36.5 mm Reach, Round Tip
	0054471799	XTDS, .181" x 1.437" / 4.6 mm x 36.5 mm Reach, Round Tip
	0054471899	XTF, .047" x 1.437" / 1.2 mm x 36.5 mm Reach, Round Angled Tip



WD1000M

MULTI-FUNCTION DIGITAL SOLDERING STATION WITH PC INTERFACE

THE WELLER ADVANTAGE:

Extremely fast heat-up and ultra-fine, ultra-precise tips make this station the choice for soldering and rework on densely populated printed circuit boards.



Chrome plated aluminum pencil weighs just 75 g

Just 45 mm (1.77") tip-to-grip, so you're close to the work

Tips have integral cool comfort grips for "no-tool" tip change

FEATURES AND BENEFITS:

- Ideal for use under magnification
- Fast heat-up, thermal stability, and fine tips make it perfect for production or rework, in standard or lead-free applications
- Heating element is built into the soldering tip for super-fast heat-up and recovery
- When placed in the stand, pencil has auto-off, or temperature setback capability for extended tip life

The following functions are built into the WD1M power unit:

- Setback time: Allows programming of the number of minutes (1 – 99), before temperature sets back to idle mode.
- Standby temperature: Allows selection of desired setback temperature, down to 200°F.
- Temperature lockout: Allows supervisor to easily set a temperature that cannot be changed by the operator.
- °F/°C switching: Allows the temperature display to read in either °F or °C.
- Temperature offset: Allows the display temperature to be adjusted +/- 72°F when working with higher mass tips, where the temperature reading can be affected by the mass of the tip.
- Auto-Off Time: Allows programming the number of minutes of inactivity (1 – 999), before the station powers off automatically.
- WD1000M complete with WD1M power supply, WMRP pencil, RT3 tip, WDH50 stand and WDC2 dry cleaner 0051512599.

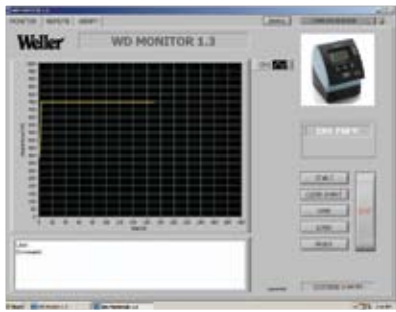

Simple PC Connection

A USB connector on the rear of the "WDxM" Series stations allows data logging, ISO verification and station control via an external PC. Free USB cable and software included.

See page 16 for components and specifications
See page 14 for RT series soldering tips



WD2000M

MULTI-FUNCTION DIGITAL SOLDERING STATION WITH PC INTERFACE AND TWO 80 WATT OUTPUTS

THE WELLER ADVANTAGE:

Allows simultaneous use of both the WMRP micro soldering pencil and the new WMRT micro desoldering tweezers. An ideal package for reworking small component circuit boards.

Silver buttons on the front panel indicate compatibility with silver soldering pencil (WMRP) and micro rework tweezers (WMRT).



FEATURES AND BENEFITS:

- Fast heat-up, thermal stability, and fine tips make it perfect for production or rework, in standard or lead-free applications.
- Heating element is built into the soldering tip for super-fast heat-up and recovery.
- When placed in the stand, both micro tools offer auto-off or temperature setback capability for extended tip life.

The following functions are built in to the WD2M power unit:

- Setback time: Allows programming of the number of minutes (1 – 99), before temperature sets back to idle mode.
- Standby temperature: Allows selection of desired setback temperature, down to 200°F.
- Temperature lockout: Allows supervisor to easily set a temperature that cannot be changed by the operator.
- °F/°C switching: Allows the temperature display to read in either °F or °C.
- Temperature offset: Allows the display temperature to be adjusted +/- 72°F when working with higher mass tips, where the temperature reading can be affected by the mass of the tip.
- Auto-Off Time: Allows programming the number of minutes of inactivity (1 – 999), before the station powers off automatically.
- WD2000M complete with WD2M power supply WMRP pencil, RT3 tip, WDH50 stand and WDC2 dry cleaner 0051512599; and WMRT thermal tweezer, RTW2 tip cartridge, WMRTH stand and 0052241999 sponge.
- USB cable and monitor software included.

Both micro size handpieces have extremely short heat-up time and optimum heat transfer capability.



The tweezers micro design employs the use of tip cartridges with a twin parallel design, so the tips are always in alignment. With the WMRT, you are able to desolder very small SMD components down to 0201.

See page 16 for components and specifications
See page 14 for RT and RTW series tips

WSM 1

COMPACT PROFESSIONAL SOLDERING STATION



SOLDERING STATIONS

THE WELLER ADVANTAGE:

Compact and convenient with professional versatility. Ideal for users who need a handy, easy-to-use soldering station that delivers professional results.

FEATURES AND BENEFITS:

- Designed for use in laboratories, service and repair facilities, and industrial plants
- Built in Stop & Go function saves energy and extends tip life
- Integrated, ergonomically designed 40W micro-soldering pencil
- High-efficiency RT3 micro-soldering chisel tip
- Safety stand with WDC dry cleaner
- Uses RT series tips (see page 14)

Specifications:

Temperature Range	200° F - 750° F (50° C - 400° C)
Heat up time	4 seconds
Output Power	40 W / 12 V
Energy-efficient switching power supply:	100 V - 240 V



WSM soldering stations feature easy-to-read touch screen control

WSM 1C

THE MOBILE, RECHARGEABLE SOLDERING STATION



FEATURES AND BENEFITS:

- Up to 1 hour soldering time
- 20 minute recharge
- Latest Lithium-ion rechargeable technology
- Integrated 40W micro-soldering pencil with RT3 micro-soldering tip
- Built in Stop & Go function saves energy and extends tip life
- Safety stand with WDC dry cleaner
- Uses RT series tips (see page 14)

Specifications:

Temperature Range	200° F - 750° F (50° C - 400° C)
Heat up time	4 seconds
Output Power	40 W / 12 V
Energy-efficient switching power supply:	100 V - 240 V







Optional Car Adapter gives the WSM 1C even more versatility
Order no. 0058751880









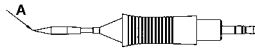

TIPS

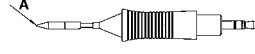
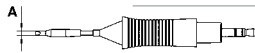
RTW TIP SETS FOR WMRT SOLDERING TWEEZER

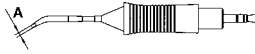
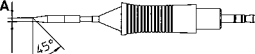
	Model	Description	Dimensions	Order No.
	RTW1	Conical	0.4 mm / .016"	45° 0054465199
	RTW2	Conical	0.7 x 0.4 mm .028" x .016"	45° 0054465299
	RTW3	Blade	3.0 x 1.0 mm .118" x .040"	45° 0054465399
	RTW4	Blade	6.0 x 1.0 mm .236" x .040"	45° 0054465499

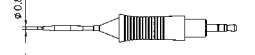
RT SERIES TIPS FOR WMRP MICRO SOLDERING PENCIL



	Model	Description	Width A	Thickness B	Order No.
	RT1	Needle tip	0.2 mm / .008"	-	0054460199
	RT1SC	Micro Chisel tip	0.4 mm / .016"	0.15 mm / .006"	0054461299
	RT2	Point tip	Ø 0.8 mm .032"	-	0054460299
	RT3	Chisel shape, straight	1.3 mm .051"	0.4 mm .0157"	0054460399
	RT4	Chisel shape, straight	1.5 mm .059"	0.4 mm .0157"	0054460499
	RT5	Chisel shape, bent, 30°	0.8 mm .032"	0.4 mm .0157"	0054460599
	RT6	Round shape, beveled, 45°	Ø 1.2 mm .047"	-	0054460699
	RT7	Knife tip, 45°	2.2 mm .0866"	-	0054460799
	RT8	Chisel tip, straight	2.2 mm .087"	0.4 mm .016"	0054460899
	RT9	Chisel tip, straight	0.8 mm .032"	0.4 mm .016"	0054460999
	RT10	Gull wing for drag soldering	1.2 mm .047"	2.0 mm .079"	0054461099
	RT11	Chisel Tip	3.6 mm .142"	0.9 mm .035"	0054461199

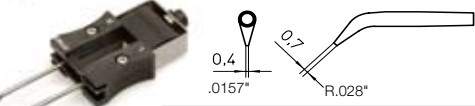
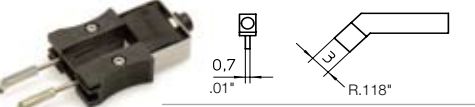
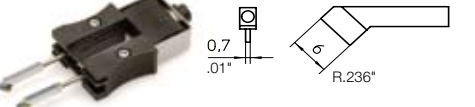

RTWMS SERIES MIL SPEC TIP SETS FOR WMRMS MIL SPEC MICRO TWEEZER

	Model	Description	Dimensions	Order No.
	RTW1MS	Conical	0.4 mm / .016" 45°	0054465599
	RTW2MS	Conical	0.7 x 0.4 mm .028" x .016" 45°	0054465799
	RTW3MS	Blade	3.0 x 1.0 mm .118" x .040" 45°	0054465899
	RTW4MS	Blade	6.0 x 1.0 mm .236" x .040" 45°	0054465999

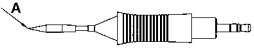
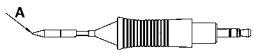
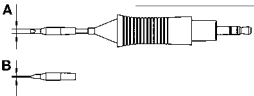
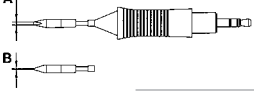
RT SERIES MIL SPEC TIPS FOR WMRPMS MIL SPEC MICRO SOLDERING PENCIL

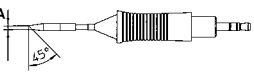
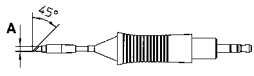
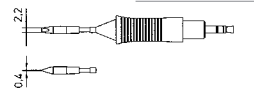
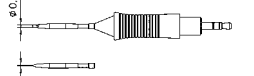
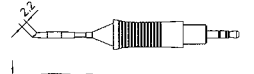
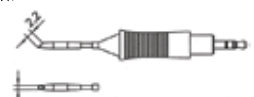
	Model	Description	Width A	Thickness B	Order No.
	RT1MS TIP	Needle tip	0.2 mm / .008"	-	0054461499
	RT1SCMS TIP	Micro Chisel tip	0.4mm / .016"	0.15 mm / .006"	0055461599
	RT2MS TIP	Point tip	Ø 0.8 mm .032"	-	0055461799
	RT3MS TIP	Chisel shape, straight	1.3 mm .051"	0.4 mm .0157"	0054461699
	RT4MS TIP	Chisel shape, straight	1.5 mm .059"	0.4 mm .0157"	0054461899
	RT5MS TIP	Chisel shape, bent, 30°	0.8 mm .032"	0.4 mm .0157"	0054461999
	RT6MS TIP	Round shape, beveled, 45°	Ø 1.2 mm .047"	-	0054462099
	RT7MS TIP	Knife tip, 45°	2.2 mm .0866"	-	0054462199
	RT8MS TIP	Chisel tip, straight	2.2 mm .087"	0.4 mm .016"	0054462299
	RT9MS TIP	Chisel tip, straight	0.8 mm .032"	0.4 mm .016"	0054462399
	RT10MS TIP	Gull wing for drag soldering	1.2 mm .047"	2.0 mm .079"	0054462499
	RT11MS TIP	Chisel Tip	3.6 mm .142"	0.9 mm .035"	0054461099

Note: MS tips must be used with a MS handle to meet the Mil Spec



PRODUCT LINE

CONFIGURED TO GIVE YOU THE MOST EFFICIENT SOLUTION



WD1M

SINGLE CHANNEL POWER UNIT

Specifications:

Voltage	120 V (input); 24 V (output)
Footprint	5.27" x 4.25" x 5.77" (134 x 108 x 147 mm)
Power consumption	160W
Temperature range	150° F - 850° F (50° C - 450° C)
ESD safe	Yes
Temperature accuracy	± 17° F (± 9° C)
Temperature stability	± 10° F (± 6° C)



WD2M

DUAL CHANNEL POWER UNIT

Specifications:

Voltage	120 V (input); 24 V (output)
Footprint	5.27" x 4.25" x 5.77" (134 x 108 x 147 mm)
Power consumption	160W
Temperature range	150° F - 850° F (50° C - 450° C)
ESD safe	Yes
Temperature accuracy	± 17° F (± 9° C)
Temperature stability	± 10° F (± 6° C)

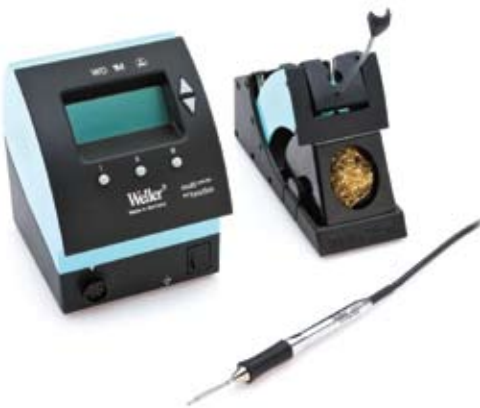

WD1000M

WD1M SINGLE CHANNEL POWER UNIT WITH WMRP MICRO SOLDERING PENCIL AND WDH50 SOLDERING PENCIL STAND

Specifications:

Voltage	120 V (input); 24 V (output)
Footprint	5.27" x 4.25" x 5.77" (134 x 108 x 147 mm)
Power consumption	160W
Temperature range	150° F - 850° F (50° C - 450° C)
ESD safe	Yes
Temperature accuracy	± 17° F (± 9° C)
Temperature stability	± 10° F (± 6° C)
Stand	WDH50 (Order No. 0051515699)
Pencil	WMRP (Order No. 0052917199)



WD2000M

WD2M DUAL CHANNEL POWER UNIT WITH WMRP MICRO SOLDERING PENCIL AND WDH50 SOLDERING PENCIL STAND, PLUS WMRT MICRO THERMAL TWEezer AND WMRTH STAND

Specifications:

Voltage	120 V (input); 24 V (output)
Footprint	5.27" x 4.25" x 5.77" (134 x 108 x 147 mm)
Power consumption	160W
Temperature range	150° F - 850° F (50° C - 450° C)
ESD safe	Yes
Temperature accuracy	± 17° F (± 9° C)
Temperature stability	± 10° F (± 6° C)
Stands	WDH50 (Order No. 0051515699) WMRTH (Order No. 0051514699)
Pencil	WMRP Micro Soldering Pencil (Order No. 0052917199)
Tweezer	WMRT Micro Tweezers (Order No. 0051317399)

COMPATIBILITY

MULTIPLE OPTIONS | WELLER POWER UNITS AND ACCESSORIES

	WD1	WD2	WD1M	WD2M	TIP STYLE
 WSP80	■	■	■	■	LT SERIES
 WP80	■	■	■	■	LT SERIES
 WMP	■	■	■	■	NT SERIES
 WMRP			■	■	RT SERIES
 WMRPMS			■	■	RTWMS SERIES
 WMRT			■	■	RTW SERIES
 WMRTMS			■	■	RTWMS SERIES
 WTA50	■	■	■	■	WTA SERIES
 WSP150		■	■ ¹	■	LHT SERIES
 WHP80	■	■	■	■	
 WSB80	■	■	■	■	
 WSB150		■	■ ¹	■	
 FE75	■	■	■	■	LT SERIES
 WP120			■ ¹	■	XT SERIES
 MPR80	■	■	■	■	LT SERIES

1 - Base unit label must state 160 watts



ACCESSORIES

MIX AND MATCH TO BUILD YOUR OWN CUSTOM SOLUTION

See page 17 to determine accessory and power unit compatibility

WMRT

MICRO DESOLDERING TWEEZERS

(Order no. 0051317299)

The new WMRT desoldering tweezers enables precise desoldering of very small SMD components down to 0201. The high-speed regulation of the WD1M and WD2M power units drive the tweezers. Use with WMRTH support (Order no. 0051514699). For WMRT tweezers and WMRTH support in a set (Order no. 0051317399). Comes with RTW2 tip set.

- WMRTMS mil spec version (Order no. 0051317599). Tip set not included. (See page 15 for RTWMS tip sets.)



WTA50

THERMAL TWEEZERS

(Order no. 0051317199)

This 50W / 24V tool is used to desolder SMD components. The tweezer has two movable heating elements so that tip alignment can be adjusted. Use with AK51 support (Order no. 0051504299). For WTA50 tweezers and AK51 support in a set (Order no. 0053313399). Comes with WTA1 tip sets. (See tips on page 32).



WSP150

HEAVY DUTY SOLDERING PENCIL

(Order no. 0052917099)

This heavy duty 150W / 24V soldering pencil is used for jobs with extremely high heat requirements and large heat sinks. When operating with dual power units WD2 or WD2M, the second port is disabled. Use with WDH30 (0051515299) support. Comes with LHTF tip.

Available tips

Cat. No.	Order No.	Style	A	B
LHTD	0054445299	Chisel	0.197" (5.0 mm)	0.79" (2.0 mm)
LHTE	0054445199	Chisel	0.276" (7.0 mm)	0.79" (2.0 mm)
LHTF	0054445099	Chisel	0.366" (9.3 mm)	0.79" (2.0 mm)
LHTD45	0054445699	Sloped 45°	0.197" (5.0 mm)	—
LHTDX	0054446299	Chisel bent	0.199" (5.0 mm)	0.79" (2.0 mm)
LHTEX	0054446199	Chisel bent	0.276" (7.0 mm)	0.79" (2.0 mm)
LHTFX	0054446099	Chisel bent	0.354" (9.0 mm)	0.79" (2.0 mm)



WHP80

PREHEATING PLATE

(Order no. 0052702899)

This 80W / 24V preheater is used with any 80W power unit. It is used to slowly increase the temperature of a PC board prior to rework to minimize the risk of damaging sensitive components. Heating surface is (3.15" x 1.97") 80 mm x 50 mm. The temperature range is adjustable from 150°F to 850°F (66°C to 454°C).



WSB80

SOLDER BATH
(Order no. 0052704099)

The 80W / 24V solder bath is used with any 80W power unit. The solder bath is used as a rework preparation tool to tin wire ends and to clean and tin component leads. It can also be used to clean extraneous solder particles in preparation for rework. Temperature range is adjustable from 150°F to 850°F (66°C to 454°C). Compatible with lead free solders. Bath dimensions 0.79" x 0.98" depth (20 mm x 25 mm depth).



WSB150

SOLDER BATH
(Order no. 0052704299)

The WSB150 solder bath is ideally suited to tin coating and preparation of soldering components. The heat output is 150W / 24V and the adjustable temperature range is 150°F – 999°F (66°C - 537°C). When operating with dual power units WD2 or WD2M, the second port is disabled. Bath dimensions 2.28" x 1.30" x 0.748" depth (58 mm x 33 mm x 19 mm depth).



FE75

FUME EXTRACTION SOLDERING PENCIL
(Order no. 0052916699)

80W / 24V soldering pencil with integral fume extraction assembly. Compatible with any 80 watt power unit and WFE2P self-contained fume extraction system. Temperature is adjustable from 150°F to 850°F (66°C to 454°C). Includes a 5 mm cylinder brush for cleaning and a funnel for support when not in use. Uses LT series tips and comes with LTB tip.



WP120

HIGH-POWER SOLDERING PENCIL
(Order no. 0052919399)

120W / 24V pencil is perfect for lead-free and other heavy-duty soldering applications. ESD safe to protect sensitive components. Comes with XTB tip.



MPR80

PERITRONIC IRON
(Order no. 0053313199)

80W / 24V Peritronic soldering pencil has offset tip for all-around visibility when making intricate connections. Electronically temperature controlled. ESD safe antistatic cord and handle. Comes with LTB tip and KH25P stand.



ACCESSORIES

MIX AND MATCH TO BUILD YOUR OWN CUSTOM SOLUTION

See page 17 to determine accessory and power unit compatibility

WSP80

80 WATT SOLDERING PENCIL

A micro soldering pencil, 80 W/24V. This soldering pencil can be universally used in all situations from extremely delicate soldering to those where there is a greater temperature requirement. Use with WDH10 support (Order no. 0051512199) or WDH10T "Stop and Go" support (Order no. 0051516199). Comes with LTB tip.



WP80

80 WATT SOLDERING PENCIL WITH SHORT GRIP

(Order no. 0052918099)

A micro soldering pencil, 80W / 24V. Similar in use and performance to the WSP80. Comes with a short barrel grip so you can get close to the work. Optional longer grip (Order no. 0058744846) is available. Use with WDH10 support (Order no. 0051512199) or WDH10T "Stop and Go" support (Order no. 0051516199). Comes with LTB tip.



WMP

MICRO SOLDERING PENCIL

The 65W / 24V pencil is up to the task with superior performance for both heat-up and thermal efficiency. Suitable to handle all micro components and fine pitch tasks. The WMP provides an extremely short tip-to-grip distance. The heater is integrated into the handle. When the tip wears out, the heating element lives on. Use with WDH20 support (Order no. 0051512299) or WDH20T "Stop and Go" support (Order No. 0051516299). Comes with NT1 tip.



WMRP

MICRO SOLDERING PENCIL

(Order no. 0052917199)

The WMRP soldering pencil has an extremely short heat-up time. All component parts of the system, such as the sensor and heating element, are designed for optimum heat transfer. This ensures absolute efficiency in the utilization of the power provided by the power unit. Changing soldering tips is quick, easy, and requires no tools. Use with WDH50 support (Order no. 0051515699). Comes with RT3 tip.

- WMRPMS mil spec version (Order no. 0052919299), tip not included. See page 15 for RTMS tips.



WES51

ANALOG SOLDERING STATION

SOLDERING STATIONS

THE WELLER ADVANTAGE:

A powerful and economical continuous production soldering station, this unit has temperature lockout and automatic power-down features to keep you in control.



Wireless lockout limits maximum temperature

Slim, comfortable pencil reduces operator fatigue

FEATURES AND BENEFITS:

- Designed for continuous production, rework, and repair of through hole, SMT boards, most ground planes, and light to medium layer boards
- Wireless temperature lockout prevents operator from raising temperature to levels higher than specified for the board or component (PW50 lockout probe)
- Station automatically powers down after 99 minutes of inactivity to prolong tip life and save power
- Pencil is fitted with non-burnable silicone rubber cord for added safety
- Pencil uses ET series tips found on page 23

Components and Specifications:

WES51PU Power Unit

Voltage	120 V (input); 24 V (output)
Temperature Range	350° F - 850° F (176° C - 450° C)
Dimensions	5.9 x 4.5 x 3.6 in. (150 x 114 x 91 mm)
Temperature Accuracy	+/- 17° F (+/-9° C)
Temperature Stability	+/- 10° F (+/-6° C)
ESD Safe	Yes

PES51 Pencil

Power Consumption	50 W
Heating Element Type	Nichrome Wound; Fiberglass and Ceramic Insulated
Cord Length	4 ft. (1.22 m)
Supplied Tip	ETA
Supplied Stand	PH50 with TC205 Sponge



Wireless temperature lockout gives you control over the process.



WESD51

DIGITAL SOLDERING STATION

THE WELLER ADVANTAGE:

A powerful and economical continuous production soldering station, this unit has temperature lockout, automatic power-down features, and a digital display to keep you in control.



Digital readout for accurate temperature control

Wireless lockout limits maximum temperature

Slim, comfortable pencil reduces operator fatigue

FEATURES AND BENEFITS:

- Designed for continuous production, rework, and repair of through hole, SMT boards, most ground planes, and light to medium layer boards
- Wireless temperature lockout prevents operator from raising temperature to levels higher than specified for the board or component (PW50 lockout probe)
- Digital readout allows quick and accurate temperature control
- Station automatically powers down after 99 minutes of inactivity to prolong tip life and save power
- Pencil is fitted with non-burnable silicone rubber cord for added safety
- Pencil uses ET series tips found on page 23

Components and Specifications:

WESD51PU

Voltage	120 V (input); 24 V (output)
Temperature Range	350° F - 850° F (176° C - 450° C)
Dimensions	5.9 x 4.5 x 3.6 in. (150 x 114 x 91 mm)
Temperature Accuracy	+/- 17° F (+/-9° C)
Temperature Stability	+/- 10° F (+/-6° C)
ESD Safe	Yes

Power Unit

Voltage	120 V (input); 24 V (output)
Temperature Range	350° F - 850° F (176° C - 450° C)
Dimensions	5.9 x 4.5 x 3.6 in. (150 x 114 x 91 mm)
Temperature Accuracy	+/- 17° F (+/-9° C)
Temperature Stability	+/- 10° F (+/-6° C)
ESD Safe	Yes

PES51 Pencil

Power Consumption	50 W
Heating Element Type	Nichrome Wound; Fiberglass and Ceramic Insulated
Cord Length	4 ft. (1.22 m)
Supplied Tip	ETA
Supplied Stand	PH50 with TC205 Sponge



Wireless temperature lockout gives you control over the process.

TIPS

ET SERIES TIPS FOR PES50/51 AND EC1201 SERIES SOLDERING PENCILS - TINNED WITH LEAD FREE SOLDER

THE WELLER ADVANTAGE:

The sensor hole in the base of the tip is fitted with a stainless steel liner to prevent the tip from seizing to the sensor.

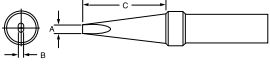
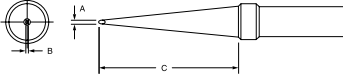
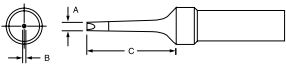
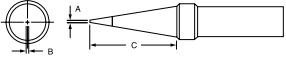
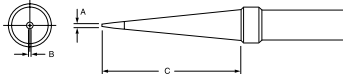
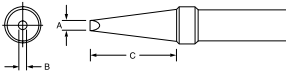
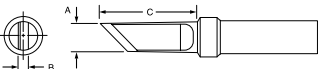
SCREWDRIVER		A		B		C	
Cat No.	IN.	MM	IN.	MM	IN.	MM	
	ETA*	0.062	1.60	0.032	0.81	0.625	15.90
	ETB*	0.093	2.40	0.020	0.51	0.625	15.90
	ETC*	0.125	3.20	0.027	0.69	0.625	15.90
	ETD	0.187	4.80	0.035	0.89	0.625	15.90
	ETH	0.031	0.80	0.019	0.48	0.625	15.90
LONG SCREWDRIVER		A		B		C	
Cat No.	IN.	MM	IN.	MM	IN.	MM	
	ETJ	0.031	0.80	0.012	0.30	1.000	25.40
	ETK*	0.046	1.20	0.026	0.66	1.000	25.40
	ETL	0.078	2.00	0.027	0.69	1.000	25.40
	ETM	0.125	3.20	0.037	0.94	1.000	25.40
NARROW SCREWDRIVER		A		B		C	
Cat No.	IN.	MM	IN.	MM	IN.	MM	
	ETR	0.062	1.60	0.044	1.12	0.625	15.90
CONICAL		A		B		C	
Cat No.	IN.	MM	IN.	MM	IN.	MM	
	ETP*	0.031	0.80	0.012	0.30	0.625	15.90
	ETT	0.024	0.60	0.036	0.91	0.625	15.90
LONG CONICAL		A		B		C	
Cat No.	IN.	MM	IN.	MM	IN.	MM	
	ETO*	0.031	0.80	0.044	1.12	1.000	25.40
	ETS*	0.015	0.40	--	--	1.000	25.40
SINGLE FLAT		A		B		C	
Cat No.	IN.	MM	IN.	MM	IN.	MM	
	ETAA	0.062	1.60	0.040	1.02	0.625	15.90
	ETBB	0.093	2.40	0.032	0.81	0.625	15.90
	ETCC	0.125	3.20	0.032	0.81	0.625	15.90
	ETDD	0.187	4.80	0.032	0.81	0.625	15.90
	ETU	0.015	0.40	--	--	0.700	17.80
	ETV	0.024	0.60	--	--	0.700	17.80
KNIFE		A		B		C	
Cat No.	IN.	MM	IN.	MM	IN.	MM	
	ETKN	0.180	4.57	0.064	1.63	0.625	15.90

* Indicates available bulk (100 multiples only)



WTCPT

TEMPERATURE CONTROLLED SOLDERING STATION

THE WELLER ADVANTAGE:

Three tip-dependent temperature options provide maximum control and make this unit perfect for repetitive, basic production, rework and repair applications.



FEATURES AND BENEFITS:

- Unique closed loop temperature control
- Ferromagnetic sensor in tip controls temperature, so no adjustment is required
- Most tips available in three standard temperature ranges (600° F, 700° F, 800° F) for maximum control
- Lighted rocker switch indicates on-off status
- Pencil uses PT series tips found on page 25

Components and Specifications:

PU120T Power Unit

Voltage	120 V (input); 24 V (output)
Power Consumption	60 W
Temperature Range	600°F; 700°F; 800°F (316°C; 371°C; 427°C)
Dimensions	5.9 x 4.5 x 3.6 in. (150 x 114 x 91 mm)
ESD Safe	Yes

TC201T Pencil

Power Consumption	42 W
Heating Element Type	Nichrome Wound, Plug-in
Cord Length	4 ft. (1.22 m)
Supplied Tip	PTA7
Supplied Stand	PH1201ESD
Sponge	TC205

TIPS

PT SERIES TIPS FOR TC201/TCP SERIES SOLDERING PENCILS. TINNED WITH LEAD FREE SOLDER

SCREWDRIVER

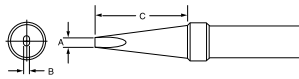

Catalog Numbers			A		B		C	
600°	700°	800°	IN.	MM	IN.	MM	IN.	MM
PTH6	PTH7	PTH8	0.031	0.79	0.019	0.48	0.62	15.87
PTA6	PTA7*	PTA8*	0.062	1.57	0.032	0.81	0.62	15.87
--	PTB7*	PTB8*	0.093	2.38	0.020	0.51	0.62	15.87
--	PTC7*	PTC8*	0.125	3.17	0.027	0.69	0.62	15.87
--	PTD7	PTD8*	0.187	4.74	0.035	0.89	0.62	15.87
--	--	PTE8	0.234	5.95	0.042	1.07	0.62	15.87

LONG SCREWDRIVER

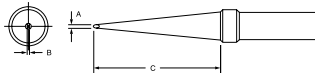

Catalog Numbers			A		B		C	
600°	700°	800°	IN.	MM	IN.	MM	IN.	MM
--	PTJ7	PTJ8	0.031	0.79	0.012	0.30	1.00	25.40
--	PTK7*	PTK8	0.046	1.19	0.026	0.66	1.00	25.40
--	PTL7	PTL8	0.078	1.98	0.027	0.69	1.00	25.40
--	PTM7	PTM8	0.125	3.17	0.037	0.94	1.00	25.40

NARROW SCREWDRIVER

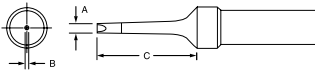

Catalog Numbers			A		B		C	
600°	700°	800°	IN.	MM	IN.	MM	IN.	MM
PTR6	PTJ7	PTJ8	0.062	1.58	0.044	1.12	0.62	15.87

SINGLE FLAT

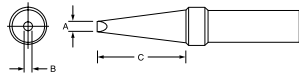

Catalog Numbers			A		B		C	
600°	700°	800°	IN.	MM	IN.	MM	IN.	MM
--	PTAA7	PTAA8	0.062	1.57	0.040	1.42	0.62	15.87
--	PTBB7	PTBB8	0.093	2.38	0.032	0.81	0.62	15.87
--	PTCC7	PTCC8	0.125	3.17	0.032	0.81	0.62	15.87
--	PTDD7	PTDD8	0.187	4.74	0.032	0.81	0.62	15.87

CONICAL

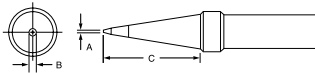

Catalog Numbers			A		B		C	
600°	700°	800°	IN.	MM	IN.	MM	IN.	MM
PTP6	PTP7*	PTP8*	0.031	0.79	0.012	0.30	0.62	15.87

LONG CONICAL

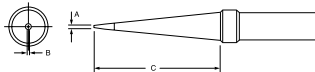

Catalog Numbers			A		B		C	
600°	700°	800°	IN.	MM	IN.	MM	IN.	MM
--	PTS7	PTS8	0.015	0.39	--	--	1.00	25.40
PTO6	PTO7*	PTO8*	0.031	0.79	0.044	1.12	1.00	25.40

CONICAL FLAT

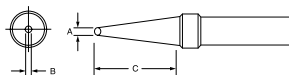

Catalog Numbers			A		B		C	
600°	700°	800°	IN.	MM	IN.	MM	IN.	MM
--	PTF7	PTF8	0.047	1.19	0.033	0.84	0.62	15.87



* Indicates available bulk (100 multiples only)

WDD81X

DIGITAL SHOP AIR DESOLDERING STATION

THE WELLER ADVANTAGE:

With 80 watts of power, this shop air system handles even the heaviest ground planes and multi-layer boards quickly, reducing the risk of component damage.



NEW Disposable solder trap on the DXV80 makes clean out quick and easy

FEATURES AND BENEFITS:

- Vacuum delay feature allows solder to reach the collection chamber before vacuum is shut off to avoid clogging
- Digital process control allows exact temperature set for added control
- Optional WCB1 control module provides temperature lock-out for process control, temperature set-back for extended tip life, and ° F to ° C conversion
- DXV80 pencil uses DX series desoldering tiptlets found on page 32

Components and Specifications:

Power Unit

Voltage	120 V (input); 24 V (output)
Power Consumption	95 W
Temperature Range	150° F - 850° F (50° C - 450° C)
Dimensions	7.1 x 4.51 x 4 in. (180 x 115 x 101 mm)
Pump Type	Compressed air / venturi converter
Vacuum Pressure	21 in. HG (0.8 Bar)
Temperature Stability	+/- 10° F (+/-6° C)
ESD Safe	Yes

DXV80 Pencil (Order No. 0051318099)

Power Consumption	80 W
Heating Element Type	Nichrome Wound
Cord Length	4 ft. (1.22 m)
Supplied Tiptlet	DX112
Solder Collection Tubes	0058741815
Supplied Stand	WDH40 (Order No. 0051515399)
Sponge	Order No. 0052241999



The new patented threadless DX desoldering tiptlets will not seize to the heater.

DSX80 Desoldering Iron 80 W / 24 V
(Order no. 0051319099) DSX80 with
WDH30 stand (Order no. 0051318399)
(optional accessory)



WR2

DIGITAL SELF-CONTAINED 2-CHANNEL REWORK STATION

THE WELLER ADVANTAGE:

The extremely capable WR2 has the power to efficiently repair state-of-the-art electronic subassemblies and the versatility to serve as the foundation for several other Weller rework and repair products.

FEATURES AND BENEFITS:

- Self-contained air and vacuum
- Economy (ECO) button for "sleep mode"
- Programmable temperature presets for immediate temperature selection
- 2 independent tool channels with automatic tool recognition
- Simultaneous use of 2 tools (up to maximum 300 W power rating of the unit)
- ESD safe

Components and Specifications:

Dimensions	L x W x H (inches): 10.75 x 9.25 x 4.02 in. (273 x 235 x 102 mm)
Power supply voltage	120 V (input); 24 V (output)
Power consumption	300 Watts
ESD Safe	Yes
Temperature range	150°F – 850°F (50°C - 450°C)
Pump Type	Rotary Vane
Air Volume Hot Air	10 l/min
Vacuum Pressure	0.7 bar (20.7 in/Hg)
Temperature accuracy	± 17° F (± 9° C)
Temperature stability	± 10° F (± 6° C)

Note: Not compatible with Weller Micro-Tools, WMRP/WMRPMS and WMRT/WMRTMS



WR2000X

WR2 DIGITAL REWORK STATION WITH DXV80 DESOLDERING PENCIL AND WDH40 TOOL STAND

FEATURES AND BENEFITS:

- All features and benefits of the WR2 above, plus...
- DXV80 80-watt desoldering pencil uses DX series desoldering tiplests found on page 32
- **NEW** Disposable solder trap on the DXV80 makes cleanout quick and easy

Components and Specifications:

Same as WR2 above

Order No.	Model	Description
0051318099	DXV80	Desoldering iron 80 W / 24 V with DX112 desoldering tiplest
0051515399	WDH40	Safety rest



DXV80 with disposable solder trap

Note: Not compatible with Weller Micro-Tools, WMRP/WMRPMS and WMRT/WMRTMS



WR2000VX

SELF CONTAINED SOLDER / DESOLDER STATION

THE WELLER ADVANTAGE:

Soldering and desoldering pencils, each with 80 watts of power, make this the perfect station for demanding work on heavy ground planes and multi-layer boards.



NEW Disposable solder trap on the DXV80 makes cleanout quick and easy



FEATURES AND BENEFITS:

- Vacuum delay feature
- Microprocessor with digital read-out for complete accuracy and reliability
- Higher power means less time spent on the PCB, reducing risk of component damage
- Programmable temperature setback
- WP80 pencil uses LT series tips found on page 5
- DXV80 pencil uses DX series desoldering triplets found on page 32

Components and Specifications:

Dimensions	L x W x H (inches): 10.75 x 9.25 x 4.02 in. (273 x 235 x 102 mm)
Power supply voltage	120 V (input); 24 V (output)
Power consumption	300 Watts
ESD Safe	Yes
Temperature range	150°F – 850°F (50°C - 450°C)
Pump Type	Rotary Vane
Air Volume Hot Air	10 l/min
Vacuum Pressure	0.7 bar (20.7 in/Hg)
Temperature accuracy	± 17° F (± 9° C)
Temperature stability	± 10° F (± 6° C)

Order No.	Model	Description
0053377699	WR2	Power unit, 300 W
0052918099	WP80	Soldering iron 80 W fitted with LTB soldering tip
0051515299	WDH10	Safety rest
0051318099	DXV80	Desoldering iron 80 W / 24 V fitted with DX112 desoldering triplet
0051515399	WDH40	Safety rest

WR3000M

DIGITAL REWORK AND REPAIR SYSTEM

REWORK
STATIONS

THE WELLER ADVANTAGE:

Automatic tool detection with three tool channels, the widest variety of tool options, and 400 watts of power give this system the versatility to meet your most demanding application requirements on the production line or in the lab.



FEATURES AND BENEFITS:

- 3 tool channels with automatic tool detection
- Large LCD screen clearly displays tip temperature and other critical information
- Self-contained with internal vacuum for maximum portability
- Mini USB port for supplied software connectivity allowing for monitoring and data logging
- All high-speed micro-tools can be used
- Versatile but simple to use
- Static Free Air
- WR3000M complete with WR3M 400W power supply, DXV80 desoldering iron with WDH40 stand, WP80 soldering iron with WDH10T Stop & Go stand, WVP vacuum pick up, nozzle adapter for HAP200 hot-air pencil, CD with USB Software and operating instructions, USB cable, nozzle replacement tool, R04 (Order No. 0058727821) and R06 (Order No. 0058727822) hot gas nozzles, DX112 and DX113 desoldering tipleets, desoldering cleaning tools, brush, spare filters and color-coded clips for easy tool identification











Components and Specifications:



Dimensions	L x W x H (inches): 10.75 x 9.25 x 4.02
Weight	Approximately 14.8 lbs.
Power supply voltage	120 VAC, 60 Hz
Power consumption	400 Watts
ESD Safe	All Tool Handles, Cordsets and Air Flow are Static Free
Fuse	4 Amp
Temperature control range	Variable in (1) degree increments from 150°F – 999°F Controllable temperature range is tool-dependent
Temperature accuracy	± 17°F (Average tip temperature can be offset ± 9°F at idle with no load)
Temperature stability	± 9°F
Hot Air / Vacuum Pump (duty cycle: 30 seconds on, 30 seconds off)	Max. vacuum 0.7 bar Max. delivery rate 18 l/min Hot air max. 15 l/min Max. vacuum 0.5 bar
Vacuum Pick-up Pump (duty cycle: 60 seconds on, 30 seconds off)	Max. delivery rate 1.7 l/min



ACCESSORIES

OPTIONAL TOOLS FOR REWORK SYSTEMS

	Part No.	Order No.	Tip Supplied / Description
	WSP80	WSP80	LTB Tip
	WP80	0052918099	LTB Tip
	WMP	WMP	NT1 Tip
	WMRP	0052917199	RT3 Tip
	WMRPMS	0052919299	RTMS Tips, No Tip Supplied
	WMRT	0051317299	RTW2 Tip, Cartridge
	WMRT-MS	0052919299	RTWMS Tips, No Tip Supplied
	WTA50	0051317199	WTA1 Tip
	WSP150	0052917099	LHTF Tip
	WP120	0052919399	XTB Tip

	Part No.	Order No.	Tip Supplied / Description
	WP200	0052920099	XHTD TIP
	MPR80	0053313199	LTB Tip
	FE75	0052916699	LTB Tip
	WHP80	0052702899	Hot Plate, 3.2" X 2"
	WSB80	0052704099	80 Watt, Solder Bath
	WSB150	0052704299	150 Watt, Solder Bath
	HAP200	0052711799 0058727821 0058727822	200 Watt, 1.2 mm Nozzle 3.0 mm Nozzle
	HAP1	0053311499 0058727821 0058727822	100 Watt, 1.2 mm Nozzle 3.0 mm Nozzle
	DXV80	0051318199	DX112 Tiolet
	DSX80	0051319099	DX112 Tiolet

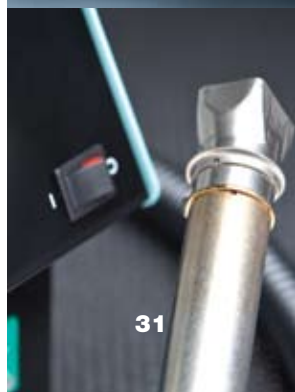

THERMAL TWEEZER TIPS

WTA SERIES TIPPLETS FOR WTA50 THERMAL TWEEZERS.
TINNED WITH LEAD FREE SOLDER

THERMAL TWEEZERS TIPS

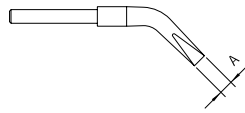

Cat No.	Order No.	A	
		IN.	MM
WTA1	0054414199	0.039	1.00
WTA2	0054414699	0.118	3.00
WTA3	0054414799	0.236	6.00

THERMAL TWEEZERS TIPS

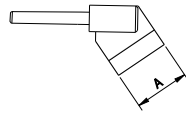

Cat No.	Order No.	A	
		IN.	MM
WTA4	0054414399	0.492	12.50
WTA5	0054414499	0.728	18.50

DESOLDERING TIPPLETS

DX SERIES TIPPLETS FOR DS80 AND DSV80

Cat No.	Order No.	A (O.D.)		B (I.D.)		C		
		IN.	MM	IN.	MM	IN.	MM	
	DX110	0051314099	0.075	1.90	0.028	0.70	0.325	18.00
	DX111	0051314199	0.098	2.50	0.028	0.70	0.325	18.00
	DX112	0051314299	0.091	2.30	0.039	1.00	0.325	18.00
	DX113	0051314399	0.098	2.50	0.047	1.20	0.325	18.00
	DX113HM High Mass Tipplet	0051315099	0.098	2.49	0.047	1.19	0.906	23.00
	DX114	0051314499	0.130	3.30	0.071	1.80	0.325	18.00
	DX115	0051314599	0.075	1.90	0.028	0.70	0.325	18.00
	DX116	0051314699	0.106	2.70	0.047	1.20	1.142	29.00
	DX117	0051314799	0.114	2.90	0.059	1.50	0.906	23.00
	DX118	0051314899	0.059	1.50	0.058	0.71	0.906	23.00
	DX119 Non-Wetting Tipplet	0051315199	0.043	1.10	0.028	0.71	1.22	31.00
	DX120 Pad Cleaning Tipplet	0051315299	0.098	2.49	0.043	1.09	0.866	22.00

HOT AIR NOZZLES

NOZZLES FOR HAP1 / HAP200 HOT AIR PENCILS

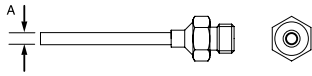
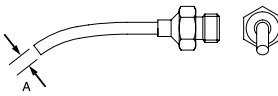
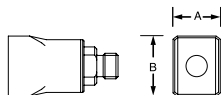
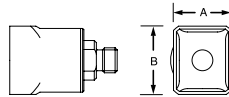
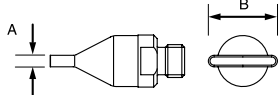
ROUND		Cat No.	A		B	
			IN.	MM	IN.	MM
		0058727823	0.031	0.80	--	--
		0058727821	0.047	1.20	--	--
		0058727787	0.098	2.50	--	--
		0058727822	0.118	3.00	--	--
ROUND BENT		Cat No.	A		B	
			IN.	MM	IN.	MM
		0058727786	0.079	2.00	--	-
2-SIDES HEATED		Cat No.	A		B	
			IN.	MM	IN.	MM
		0058727782	0.394	10.00	0.512	13.00
		0058727781	0.394	10.00	0.591	15.00
		0058727784	0.394	10.00	0.709	18.00
		0058727779	0.413	10.50	0.413	10.50
4-SIDES HEATED		Cat No.	A		B	
			IN.	MM	IN.	MM
		0058727777	0.236	6.00	0.256	6.50
		0058727778	0.236	6.00	0.354	9.00
		0058727780	0.394	10.00	0.591	15.00
		0058727783	0.492	12.50	0.591	15.00
		0058727785	0.709	18.00	0.709	18.00
FLAT		Cat No.	A		B	
			IN.	MM	IN.	MM
		0058727774	0.059	1.50	0.315	8.00
		0058727773	0.059	1.50	0.394	10.00
		0058727772	0.059	1.50	0.472	12.00

* HAP200 Requires M6 Nozzle Adapter (Order No. 0058761728)



WHA3000PS

DIGITAL HOT AIR REWORK SYSTEM

THE WELLER ADVANTAGE:

This station has high-end versatility to meet your most demanding rework challenges, including repair of fine-pitch components on densely-packed boards.



WBHS

Circuit board holder with hot air pencil stand holds the HAP3 hot air pencil perpendicular to the printed circuit board under repair, raises and lowers it precisely onto the component being reworked.



WHA3000P

700-watt hot air station features patented Weller nozzle technology for maximum process control and user friendly operation, plus a powerful variable speed-controlled turbine for an air volume of up to 50 liters/min

WHA3000PS Components & Specifications:

WHA3000P	Power Unit
Voltage	120V (Input)
Power Consumption	700 W
Temperature Range	150° F – 999° F (50° C – 550° C)
Dimensions	9.5 x 10.6 x 6.7 in. (240 x 270 x 170 mm)
Pump Type	Maintenance-free Rotary Vane
Vacuum Pressure	-0.6 bar
Air Flow Volume	5 l/min. – 50 l/min.
Temperature Accuracy	+/- 54° F (+/- 30° C)
ESD Safe	Yes

WBHS Circuit Board Holder with Tool Stand
Order No. 0053316599
(See Page 36 of this catalog for specifications)

WHP3000 Heating Plate
(See Page 36 of this catalog for specifications)

FEATURES AND BENEFITS:

- 700 watts of power allow work on larger dual in line and quad pack components
- An ion trap assures that only ESD safe hot air is directed at the component
- Memory to store up to 10 thermal profiles ensures process repeatability
- Holds circuit boards up to 310 mm x 320 mm for outstanding versatility
- IR heating plate has a total heated area of 120 mm x 190 mm with 3 ceramic elements for controlled, even heat.
- Set and read temperatures are digitally displayed
- An external sensor can be connected to display actual temperatures at specific areas of the circuit under repair to further guard against damage to sensitive components
- The hot plate can be controlled from its own independently or integrated into the control system of the WHA3000P or WHA3000V
- Three position foot switch: OFF – HOT AIR – VACUUM
- Self contained internal air and vacuum
- System includes a 0.669" x 0.925" (17.0mm x 23.5mm) hot air nozzle (Order no. 0058750721) For full range of hot air nozzles, see page 41



WHP3000

Positioned beneath the WBHS circuit board holder, this IR heating plate preheats circuit board under repair to reduce possibility of thermal damage.



WHA3000PS

COMPONENTS AND ACCESSORIES



WBHS

CIRCUIT BOARD HOLDER AND TOOL STAND

- Holds circuit boards up to 310 mm x 320 mm for outstanding versatility
- Precision glides allow board to be precisely positioned and secured at any point along the X and Y axes
- Accommodates both single and double sided boards
- Holds PCBs totally flat for added precision and repeatability
- Tool holder positions hot air pencil perpendicular to the PCB
- Smooth-acting lever raises and lowers the tool precisely onto the component 1.4 in. (35 mm) along the Z axis

WBH CIRCUIT BOARD HOLDER (not shown)

Same as WBHS, but without tool holder

WHP3000

INFRARED HEATING PLATE

- Reduces risk of thermal damage by providing controlled, even heat
- Set and read temperatures digitally displayed for added control of process
- Optional Type K thermocouple can be connected to display actual temperatures at specific areas of the circuit under repair to further guard against damage to sensitive components
- Can be used alone or beneath WBHS or WBH circuit board holders
- Can be controlled independently, or can be integrated into the control system of either the WHA3000P or the WHA3000V



Components & Specifications

WBHS

Dimensions 12.6 x 17.6 x 17.3 in. (320 x 446 x 440 mm)
Order No. 0053316599

WBH

Dimensions 12.6 x 17.6 x 3.9 in. (320 x 446 x 100 mm)
Order No. 0053316499

WHP3000

Voltage 120 V
Power Consumption 200 W (small heating zone);
600 W (large heating zone)
Temperature Range 150° F – 750° F (50° C – 400° C)
Dimensions 10.0 x 15.6 x 2.8 in. (254 x 395 x 70 mm)
ESD Safe Yes

Accessories

- 0058754873 Adjustable circuit board stop
- 0058755745 Support for large circuit boards
- 0058755741 Circuit board clamp
- 0058754924 Clamp set for irregular-shaped circuit boards (mobile phones, digital cameras, etc.)



0058754873

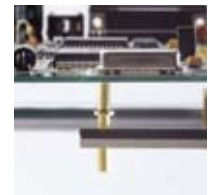

0058755745



0058755741



0058754924



WHA3000P

DIGITAL HOT AIR STATION

HOT AIR STATIONS

THE WELLER ADVANTAGE:

This 700-watt hot air station has advanced features for unsurpassed process control and a quiet, yet powerful internal air source for maximum portability.



"Stop and Go" tool holder automatically switches hot air pencil to "standby" mode, reducing air flow but maintaining operating temperature

FEATURES AND BENEFITS:

- Self-contained bench-top unit – no external air source required
- Capable of performing demanding repair tasks on PCBs with complex fine pitch surface mounted components
- Set and read temperatures are digitally displayed
- Automatic mode allows up to ten separate programs to be stored in memory, each with a unique air temperature / air volume / process time profile for the ultimate in control and process repeatability
- Special ionizing circuit assures hot air is static-free to protect sensitive components
- Optional nozzle change tool allows quick changeout of nozzles, even when hot
- Works with optional Type K thermocouple to measure temperature on specific area of PCB for more precise process monitoring
- Three position foot switch: OFF–HOT AIR–VACUUM
- System includes a 0.669" x 0.925" (17.0mm x 23.5mm) hot air nozzle (Order no. 0058750721) Hot air pencil accepts wide range of patented technology nozzles for maximum versatility, see page 41

WHA3000V

Similar to the WHA3000P, except without internal turbine air source; uses compressed air or inert gas



WHA3000P Components & Specifications

Power Unit	
Voltage	120 V
Power Consumption	700 W
Temperature Range	150° F – 999° F (50° C – 550° C)
Dimensions	9.5 x 10.6 x 6.7 in. (240 x 270 x 170 mm)
Pump Type	Rotary Vane
Vacuum Pressure	- 0.6 Bar
Air Flow Volume	5 l/min. – 50 l/min.
Temperature Accuracy	+/- 54° F (+/- 30° C)
ESD Safe	Yes

Accessories for WHA3000P and WHA3000V

0051504999	Nozzle change tool
0058755782	0.10 mm Type K external sensor
0053119099	0.50 mm Type K external sensor
0051504899	Stand for hot air nozzles



WHA900

SELF CONTAINED HOT AIR REWORK STATION

THE WELLER ADVANTAGE:

The WHA900 has a closed loop feedback that continuously monitors and controls the temperature. Set it once and forget it.

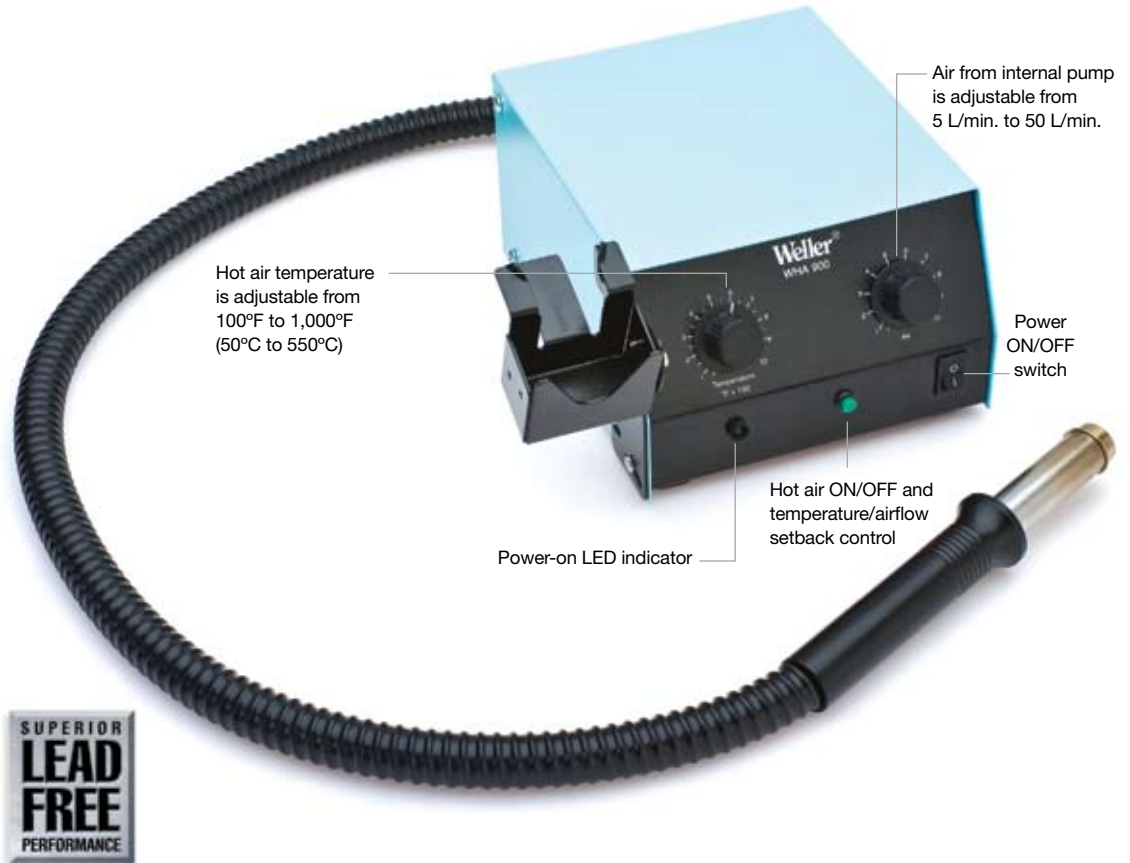

FEATURES AND BENEFITS:

- Temperature and air flow setback can be pre-selected by the user
- Closed loop feedback continuously adjusts heat output
- Hot air hand piece uses WHA nozzles found on page 41

WHA900 Components and Specifications:

Power Unit

Voltage	120 V (input); 120 V (output)
Power Consumption	750 W
Temperature Range	150° F – 1000° F or 50° C – 550° C
Dimensions	8.125 x 6.625 x 4.25 in. (206 x 168 x 108 mm)
Pump Type	Turbine
Air Flow Volume	5 l/min. – 50 l/min.
Temperature Accuracy	+/- 54° F (+/- 30° C)
ESD Safe	Yes
Closed-loop temperature control	Yes



Patented Weller nozzle technology safely removes surface mount components. Nozzle not included.



WR2000

DIGITAL SELF CONTAINED HOT AIR REWORK STATION

HOT AIR
STATIONS

THE WELLER ADVANTAGE:

Digital microprocessor control and an internal air and vacuum source give this 300-watt dual channel rework station amazing performance and versatility.



FEATURES AND BENEFITS:

- Self-contained air and vacuum
- Economy (ECO) button for "sleep mode"
- Programmable temperature presets for immediate temperature selection
- 2 independent tool channels with automatic tool recognition
- Simultaneous use of 2 tools (up to maximum 300 W power rating of the unit)
- ESD safe
- Hot air pencil uses HAP series nozzles found on page 33

Components and Specifications:

Order No.	Model	Description
WR 2	WR 2	Power unit, 300 W
0052711599	HAP 1	Hot air pencil 100 W / 24 V fitted with 3.0 round nozzle
0051515299	WDH 30	Safety rest



WAD101

DIGITAL COMPRESSED AIR HOT AIR STATION

THE WELLER ADVANTAGE:

Digital microprocessor control and the ability to use external compressed air or gas give this 100-watt hot air station amazing performance and versatility.

Analog dial for manual control of hot air flow

Digital display shows set and actual temperatures



FEATURES AND BENEFITS:

- Powerful (100-watt) HAP1 pencil precisely delivers hot air to small SMT parts, reducing the risk of damage to adjacent components
- Finger-activated hot air switch on pencil provides exceptional control
- Digital temperature control has easy-to-read LED display for fast and accurate temperature set
- Optional WCB1 programming module provides temperature lock-out for process control, temperature set-back for extended tip life, and ° F to ° C conversion
- Hot air pencil uses HAP nozzles found on page 33

WAD101 Components and Specifications:

Power Unit

Voltage	120 V (input); 24 V (output)
Power Consumption	100 W
Temperature Range	150° F – 999° F or 50° C – 550° C
Dimensions	4.5 x 5.9 x 3.6 in. (114 x 150 x 91 mm)
Air Flow Volume	1 l/min. – 6 l/min.
Temperature Accuracy	+/- 54° F (+/- 30° C)
ESD Safe	Yes

HAP1 Pencil

Power Consumption	100 W
Heating Element Type	Nichrome wound; fiberglass and ceramic insulated
Cord Length	4 ft. (1.22 m)
ESD Safe	Yes
Supplied Nozzle	1.2mm nozzle (Order No. 0058727821)
Supplied Stand	KH 27



NOZZLES

HOT AIR STATIONS

FOR WHA SERIES STATIONS

(Δ) Denotes Make To Order. Contact us for a quote and lead-time.

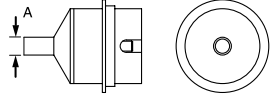
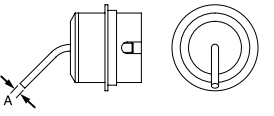
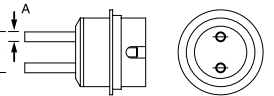
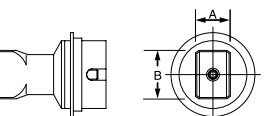
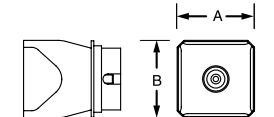
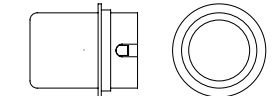
ROUND (NO VACUUM)		Cat No.	A		B	
			IN.	MM	IN.	MM
	0058736881	0.098	2.50	--	--	
	0058736867	0.157	4.00	--	--	
	0058736870	0.276	7.00	--	--	
	0058736836Δ	0.453	11.50	--	--	
ROUND BENT (NO VACUUM)		Cat No.	A		B	
			IN.	MM	IN.	MM
	0058736882	0.059	1.50	--	--	
ROUND DUAL (NO VACUUM)		Cat No.	A		B	
			IN.	MM	IN.	MM
	0058736883	0.098	2.50	0.374	9.50	
2-SIDES HEATED		Cat No.	A		B	
			IN.	MM	IN.	MM
	0058736840	0.583	14.80	0.846	21.50	
	0058736842	0.394	10.00	0.551	14.00	
	0058736843	0.421	10.70	0.421	10.70	
	0058736841	0.472	12.00	0.748	19.00	
	0058736876Δ	0.472	12.00	1.063	27.00	
	0058736857Δ	1.496	38.00	1.496	38.00	
	0058736873Δ	1.575	40.00	1.575	40.00	
4-SIDES HEATED		Cat No.	A		B	
			IN.	MM	IN.	MM
	0058736839	0.433	11.00	0.433	11.00	
	0058736818	0.583	14.80	0.583	14.80	
	0058736814	0.709	18.00	0.709	18.00	
	0058736807	0.807	20.50	0.807	20.50	
	0058736804	1.024	26.00	1.024	26.00	
	0058736833	1.260	32.00	1.260	32.00	
	0058736891	1.417	36.00	1.417	36.00	
	0058736890Δ	1.693	43.00	1.693	43.00	
	0058736838	0.394	10.00	0.571	14.50	
	0058736880Δ	0.472	12.00	0.945	24.00	
	0058736837	0.512	13.00	0.610	15.50	
	0058736892Δ	0.551	14.00	1.063	27.00	
	0058750721	0.669	17.00	0.925	23.50	
	0058736877Δ	0.669	17.00	1.142	29.00	
	0058736998Δ	0.906	23.00	1.398	35.50	
	0058736999Δ	1.201	30.50	1.909	48.50	
	0058736858Δ	1.260	32.00	1.732	44.00	
0058750709Δ	1.496	38.00	1.909	48.50		
0058750714Δ	1.496	38.00	2.402	61.00		
ROUND DUAL (ADAPTER)		Cat No.	A		B	
			IN.	MM	IN.	MM
	0058736819	--	--	--	--	
CSF REPLACEMENT RUBBER INSERTS		Cat. No.	Description			
			I.D.	O.D.		
		W58713798	Ø.6 mm stem / Ø 10 mm cup (10 pcs.)			
		W58713799	Ø.3 mm stem / Ø 4.5 mm cup (10 pcs.)			



WHP200

200 WATT IR PRE HEATER

THE WELLER ADVANTAGE:

The WHP200 is a small, powerful, infrared preheater designed to minimize the risk of thermal damage and to speed up the repair process on small multilayer PCBs.



FEATURES AND BENEFITS:

- Suitable for use with a range of consumer electronic boards. It is perfect for rework operations on digital camera, mobile phone, MP3 player, and PDA PCBs
- The infrared plate provides fast, precisely controlled heating to create an even substrate temperature
- Simple to use, with very easy adjustment for the heating temperature
- Heating plate comes complete with a PCB board holder so there is no need to buy additional accessories
- Set and read temperatures digitally displayed for added process control

WHP200 Components and Specifications:

Power Unit

Dimensions (L x W x H) incl. pcb holder	7.6 x 7.6 x 3.3 inch (193 x 193 x 84 mm)
Dimensions Heating Zone (L x W)	4.72 x 2.36 inch (120 x 60 mm)
Voltage	120 V / 50/60 Hz
Power	Heat Zone 200 W, Medium Wave Infrared
Temperature Range	150°F – 750°F (50°C – 400°C)



WHP1000

DIRECT CONTACT PREHEATER

THE WELLER ADVANTAGE:

The WHP1000 is a high power preheater that is suitable for contact preheating. Use it under a board holder, or simply place your work directly on the working surface. The WHP1000 is well suited for use with flat silicon cells as well as ceramic and glass printed circuit boards.



FEATURES AND BENEFITS:

- Allows the temperature of the board's substrate material to be raised to the correct working temperature, ensuring perfect soldering operations without the risk of damage from thermal shock to the board
- Large 8.75 x 6.00 inch pre-heating area with even heat distribution
- Four heating elements allow electronic assemblies to be pre-heated in a variety of ways
- Digitally controlled electronics ensure precise temperature regulation and support special functions such as "Auto Off" and "Standby Temperature". Set and actual temperatures can be viewed on the digital display
- An insulated Type K thermocouple (optional) can be used to monitor the temperature at specific locations on the board (0.5mm, Order no. 0053119099), (0.1mm MTO, Order no. 0058755782)
- An integrated RS232 interface enables the device to be controlled externally from the Weller WHA3000P or WHA3000V
- RoHS Compliant - MIL-SPEC compliant

WHP1000 Components and Specifications:

Power Unit

Dimensions	(W x L x H): 10.0 x 11.0 x 2.75 inches (254 x 280 x 70 mm)
Heating plate	6.0 x 8.75" (150 x 220 mm)
Power supply	120 V / 50/60 Hz
Power	850 W
Temperature range	150°F - 570°F (50°C - 300°C)
ESD Safe	Yes



WFE8S

POWERFUL FUME EXTRACTION UNIT

THE WELLER ADVANTAGE:

Its internal pre-filter and automatic airflow control make this high-capacity mobile unit the perfect choice for long filter life and energy-efficiency in applications with large amounts of particles, such as lead-free soldering.



FEATURES AND BENEFITS:

- Mobile fume extraction unit purifies air at up to eight workstations
- Large F7 pre-filter
- The adjustable pressure control provides optimal air flow regulation for each workstation
- Electronic filter control
- Four wheels to allow easy movement of the unit
- Noise-dampened metal housing
- Quick and simple installation



ESD safe



low sound level

WFE8S includes:

- Optional wired remote control (Order No. 0058735909)
- PC remote monitoring with optional RS232 interface cable (Order No. 0053119199) / software included
- WFE8S Fume Extraction Unit 120 V / 50/60 Hz with F7 pre-filter
- Compact filter Consists of: HEPA filter H13, wide band gas filter (50% active carbon, 50% chemical absorbent)
- Filters must be ordered separately (see page 53)

WFE8S Specifications:

Maximum capacity	8 workstations; small and medium sized reflow, wafer, and other selected equipment
Maximum extraction rate	615 m ³ /h
Sound level	< 55 db (A) at 1 m distance
Operating voltage	120 V / 50/60 Hz
Power input	450 VA
Maximum vacuum	2.800 Pa
Dimensions (L x W x H)	402 x 796 x 1016 mm 15.9 x 31.3 x 40 in.
Weight	68 kg / 150 lb.
Order No. 120V	WFE8S

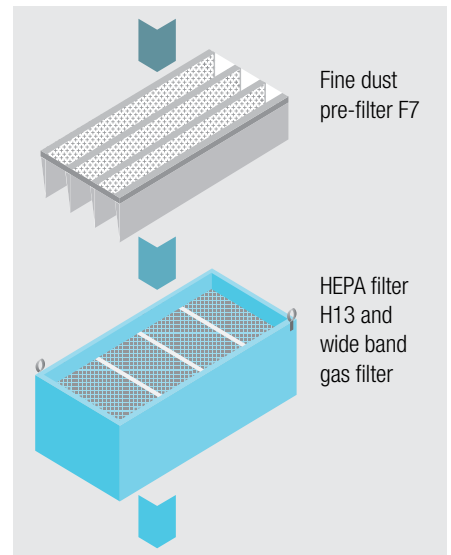

WFE4S

MOBILE FUME EXTRACTION UNIT

FUME
EXTRACTION

THE WELLER ADVANTAGE:

This extremely mobile unit offers big capacity with compact size, and comes with high-end features like automatic air flow regulation and optional remote control and remote monitoring.

FEATURES AND BENEFITS:

- Mobile fume extraction unit purifies air at up to four workstations
- The adjustable pressure control provides optimal air flow regulation for each workstation
- Electronic filter control and easy filter exchange
- Four wheels to allow easy movement of the unit
- Noise-dampened metal housing, alarm function, and quick and simple installation

WFE4S includes:

- Optional wired remote control (Order No. 0058735909)
- PC remote monitoring with optional RS232 interface cable (Order No. 0053119199) / software included
- WFE4S Fume Extraction Unit 120 V / 50/60 Hz
- Compact filter Consists of: HEPA filter H13 and wide band gas filter (50% active carbon, 50% chemical absorbent)
- Fine dust pre-filter F7
- Filters must be ordered separately (see page 53)

Option: WFE4SG with gas filter

- Compact filter for adhesive fumes; consists of wide band gas filter (50% active carbon, 50% chemical absorbent)
- Fine dust filter F7

WFE4S Specifications:

Maximum capacity	8 workstations
Maximum extraction rate	615 m ³ /h
Sound level	51 db (A) at 1 m distance
Standard connection	pipe system 75
Operating voltage	120 V / 50/60 Hz
Power input	450 VA
Maximum vacuum	2.800 Pa
Dimensions (L x W x H)	450 x 450 x 650 mm 17.7 x 17.7 x 25.6 in.
Weight	21 kg / 46.3 lb.
Order No. 120V	WFE4S

WFE 4SG with gas filter

Order No. 120V WFE4SG



ESD safe



low sound level

Pre-filter box to extend capacity of WFE2S, WFE4S, WFE2X

The pre-filter is recommended for use with solder bath, automatic soldering, laser, or other major dust-emitting flux, or solvent applications. It acts as a first stage in the filter process, increasing the lifetime of the main filter units. The pre-filter can be fixed directly to the top of the WFE4S or in conjunction with the WFE2S and WFE2X as an external part of the fume extraction system. Order No. 0058735862

Pre-filter includes:

- Filter box
- (2) hose connections 75 mm
- Filters must be ordered separately (see page 53)



WFE2X

MOBILE FUME EXTRACTION UNIT PURIFIES AIR AT UP TO TWO SOLDERING WORKSTATIONS

THE WELLER ADVANTAGE:

With variable turbine speed and filter change alarm controlled via wired remote, a compact footprint, and quiet power for up to two workstations, this unit is perfect for demanding soldering, adhesives, clean room, and laser applications.

FEATURES AND BENEFITS:

- Mobile fume extraction unit purifies air at up to two workstations
- Electronic filter monitoring and easy filter exchange
- Remote control with alarm function, noise-dampened metal housing and quick and simple installation
- Trolley available optional accessory
- Minimized footprint
- Switching power supply fits all global voltages

WFE 2X includes:

- WFE 2X Fume Extraction Unit 100-240 V / 50/60 Hz
- Compact filter Consists of: HEPA filter H13, wide band gas filter (50% active carbon / 50% chemical absorbent)
- Filters must be ordered separately (see page 53)

WFE2X Specifications:

Maximum capacity	2 workstations
Maximum extraction rate	140 m³/h
Sound level	< 52 db (A) at 1 m distance
Operating voltage	100 – 240 V / 50/60 Hz
Power input	100 W
Maximum vacuum	2.300 Pa
Dimensions (L x W x H)	210 x 460 x 660 mm
	8.3 x 18.1 x 26 in
Weight	15 kg / 33 lb.
Order No. 120V	WFE2X



ESD safe



low sound level

WFE2XKIT1

Portable fume extraction kit with flex arm for one work station
Order No. 120V - WFE2XKIT1

Includes:

- 0053658899 WFE 2X Fume Extraction Unit 100-240 V / 50/60 Hz
- 0053657199 KIT 1 WF Angled 60 for volume extraction consists of:
 - 0053657899 Extraction arm
 - 0053657399 Funnel nozzle
 - 0053657499 Stop valve
 - 0053657599 Bench mounting clamps
 - 0053657699 Extraction hose
 - 0058762753 Adapter with O ring
- Filters must be ordered separately (see page 53)



WFE2XKIT1S

Portable fume extraction kit with articulated arm for one workstation
Order No. 120V - WFE2XKIT1S

Includes:

- 0053658899 WFE 2X Fume extraction unit 100-240 V / 50/60 Hz
- 0053657999 KIT 1 WF 60 Angled articulated extraction arm for volume extraction consists of:
 - 0053659899 Articulated extraction arm with Bench mount
 - 0053657799 Angled nozzle
 - 0053657599 Bench mounting clamps
 - 0053657699 Extraction hose
 - 0053657899 Extraction arm
 - 0058762753 Adapter with O Ring
- Filters must be ordered separately (see page 53)



WFE2S

FUME
EXTRACTION

MOBILE FUME EXTRACTION UNIT AVAILABLE IN TWO KITS

THE WELLER ADVANTAGE:

This compact central system provides microprocessor-controlled suction for up to four workstations and can be easily modified with specialized filters to provide efficient fume extraction for many different applications.

FEATURES AND BENEFITS:

- Mobile fume extraction unit purifies air at up to four workstations
- Electronic filter control and easy filter exchange
- Noise-dampened metal housing, clogged filter indicator, and quick and simple installation

WFE2S includes:

- Optional wired remote control (Order No. 0058735909)
- PC remote monitoring with optional RS232 interface cable (Order No. 0053119199) / software included
- WFE2S Fume Extraction Unit 120V / 50/60 Hz
- Compact filter Consists of: HEPA filter H13, wide band gas filter (50% active carbon / 50% chemical absorbent)
- Fine dust pre-filter F7
- Filters must be ordered separately (see page 53)

Option: WFE 2SG with gas filter:

- Compact filter for adhesive fumes. Consists of: wide band gas filter (50% active carbon / 50% chemical absorbent)

WFE2S Specifications:

Maximum capacity	4 workstations
Maximum extraction rate	230 m ³ /h
Sound level	48 db (A) in 1 m distance
Standard connection	pipe system 50
Operating voltage	120 V / 50/60 Hz
Power input	275 VA
Maximum vacuum	2.700 Pa
Dimensions (L x W x H)	320 x 320 x 395 mm 12.6 x 12.6 x 15.5 in.
Weight	19 kg / 41.8 lb.
Order No. 120V	WFE2S
WFE 2S with gas filter	
Order No. 120V	WFE2SG



ESD safe



low sound level

WFE2S Kit 1

Portable fume extraction kit for one workstation. Order No. 120V - WFE2SKIT1

Includes:

- 0053626699 WFE 2S Fume Extraction Unit 120 V / 50/60 Hz
- 0053657299 KIT 1 WF Sloped 60 for volume extraction consists of:
 - 0053657899 Extraction arm
 - 0053657799 Angled nozzle
 - 0053657499 Stop valve
 - 0053657599 Bench mounting bracket
 - 0053657699 Extraction hose
- Filters must be ordered separately (see page 53)



WFE2S Kit 2

Portable fume extraction kit for one workstation. Order No. 120V - WFE2SKIT2

Includes:

- 005 36 266 99 WFE 2S Fume Extraction Unit 120 V / 50/60 Hz
- 2 x 005 36 572 99 KIT 1 WF Sloped 60 for volume extraction consists of:
 - 2 x 005 36 578 99 Extraction arm
 - 2 x 005 36 577 99 Angled nozzle
 - 2 x 005 36 574 99 Stop valve
 - 2 x 005 365 75 99 Bench mounting bracket
 - 2 x 005 36 576 99 Extraction hose
- Filters must be ordered separately (see page 53)



WFE2ES

AN ECONOMICAL SOLUTION TO FUME EXTRACTION

THE WELLER ADVANTAGE:

This unit offers serious fume extraction in an economical, compact package that's easy to install, easy to operate, and comes complete with all you need to be up and running right out of the box.



Portable fume extraction kit for one work station

FEATURES AND BENEFITS:

- Mobile fume extraction unit purifies air at up to two workstations
- Easy filter exchange
- Quick and simple installation



ESD safe low sound level

WFE2ESKIT1 includes:

- WFE 2ES Fume Extraction Unit
- Compact filter Order No. 0058762701 Consists of: HEPA filter H12, activated carbon foam
- Fine dust pre-filter F 5
- 0053657199 KIT 1 WF Funnel 60 for volume extraction consists of:
 - 0053657899 Extraction arm
 - 0053657399 Funnel nozzle
 - 0053657499 Stop valve
 - 0053657599 Bench mounting clamps
 - 0053657699 Extraction hose
 - 0058762753 Adapter
- Filters must be ordered separately (see page 53)

WFE 2ES Specifications:

Maximum capacity	2 workstations
Maximum extraction rate	220 m ³ /h
Sound level	55 db (A) at 1 m distance
Operating voltage	115V / 60Hz
Power input	115 VA
Maximum vacuum	1.800 Pa
Dimensions (L x W x H)	320 x 320 x 395 mm 12.6 x 12.6 x 15.5 in
Weight	9 kg / 19.8 lb.
Order No. 120V	WFE2ES KIT1

Option: Arm with sloped nozzle

Order No. 0053657299

Includes:

- KIT 1 WF Angled 60 for volume extraction consists of:
 - 0053657899 Extraction arm
 - 0053657799 Angled nozzle
 - 0053657499 Stop valve
 - 0053657599 Bench mounting clamps
 - 0053657699 Extraction hose
 - 0058762753 Adapter



INSTALLATION OPTIONS

FUME
EXTRACTION

INSTALLATION OPTION FOR A CENTRAL SYSTEM UTILIZING WFE 2S TOTAL PIPE LENGTH: 15 m

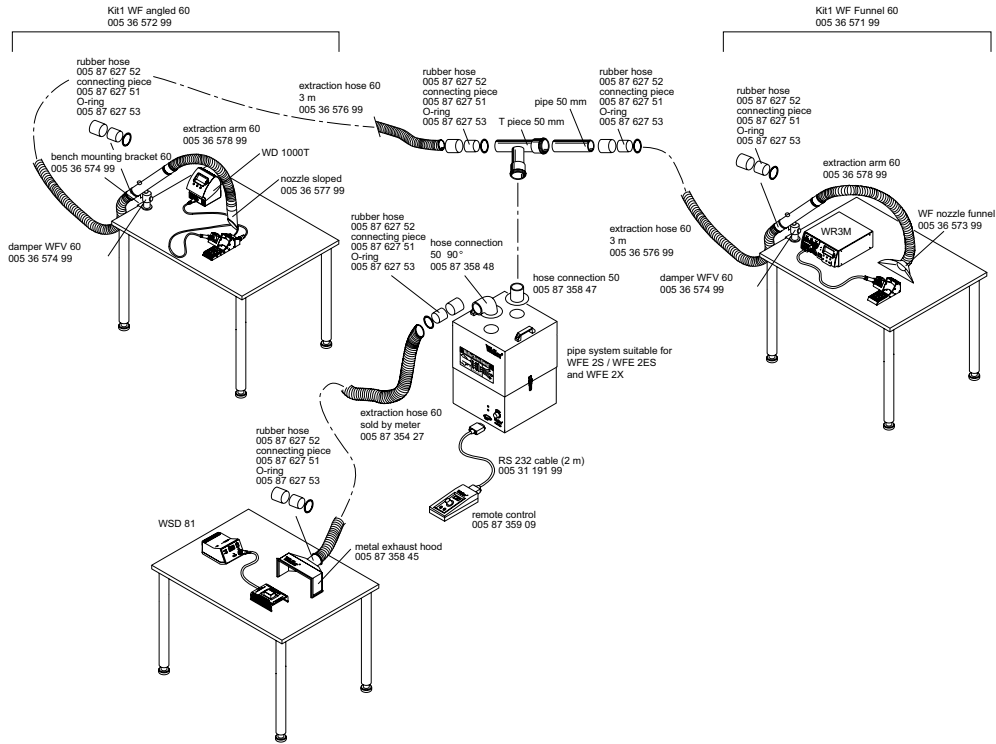

INSTALLATION OPTION FOR A CENTRAL AND STAND ALONE SYSTEM UTILIZING WFE 4S TOTAL PIPE LENGTH: 30 m

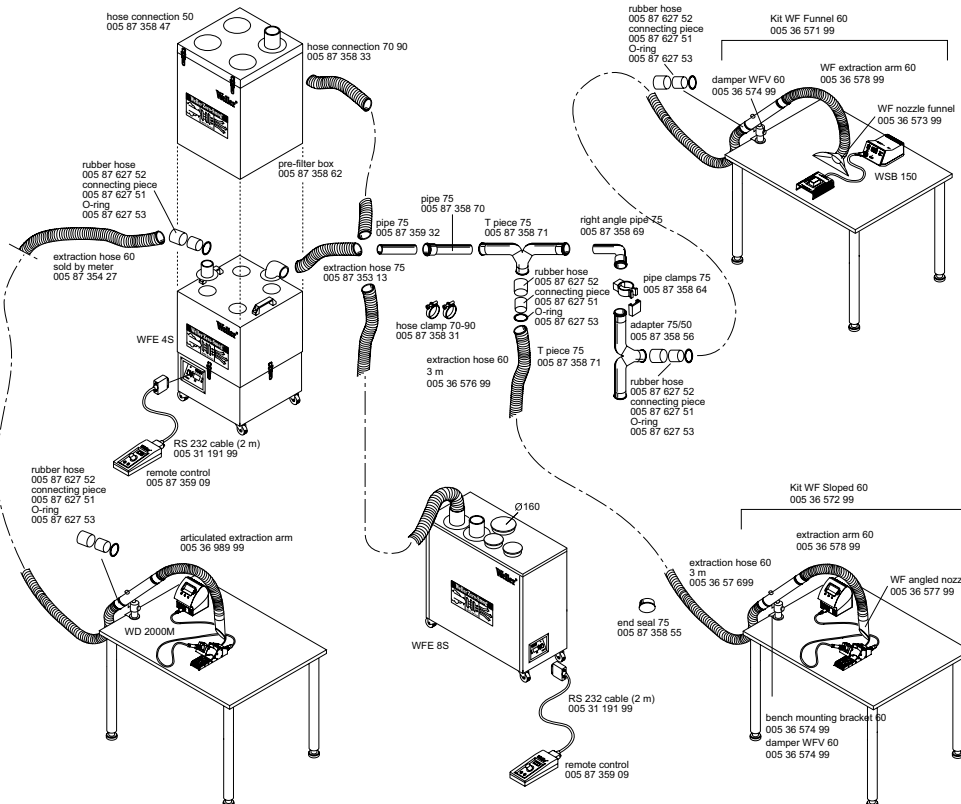

ACCESSORIES





TO BUILD YOUR OWN CUSTOM SOLUTION

When soldering, gluing, or working with solvents, it is important to place the nozzle as close to the source as possible to prevent harmful particles and gases from being spread into the work area.



The arms and nozzles feature snap-fit connections, and are simple to install, easily locking into the desired position.



HOSE CONNECTIONS

	Order No.	Description
	0058735847	Hose connection 50 for WFE 2S and WFE 4S, e.g. for the direct connection of accessories by means of 50 mm (1.96 in.) extraction hose. Black plastic.
	0058735832	Hose connection 75 for WFE 2S and WFE 4S, e.g. for connection to a stand alone system by means 75 mm (2.95 in.) pipe or 75 mm (2.95 in.) extraction hose. Black plastic.
	0058735848	Hose connection 50, 90° for WFE 2S and WFE 4S, e.g. for the direct connection of accessories by means of 50 mm (1.96 in.) extraction hose. Black plastic.
	0058735833	Hose connection 75, 90° for WFE 2S and WFE 4S, e.g. for connection to a stand alone system by means of 75 mm (2.95 in.) pipe or 75 mm (2.95 in.) extraction hose. Black plastic.

EXTRACTION HOSES

	Order No.	Description
	0058735313	Extraction hose 75, 75 mm (2.95 in.), for connection to pipe system 75. Sold by the meter. Flexible gray/black plastic.
	0053657699	Extraction hose 60, 60 mm (2.36 in.), for connection to pipe system 50. 3 m (118.11 in.). Flexible gray/black plastic.
	0058735427	Extraction hose 60, 60 mm (2.36 in.), for connection to pipe system 50. 1 m (39.37 in.). Flexible gray/black plastic. Sold by the meter.

HOSE CLAMPS

	Order No.	Description
	0058735879	Hose clamp 50 - 70 mm, (1.96 - 2.75 in.) set of two, for securing extraction hose 50.
	0058735831	Hose clamp 70 - 90 mm, (2.75 - 3.54 in.) set of two, for securing extraction hose 75.

ARTICULATED EXTRACTION ARM



Order No.

0053659899

Description

Articulated extraction arm, 60 mm diameter, with two articulated joints and bench clamp. ESD safe.

FLEXIBLE EXTRACTION ARMS



Order No.

0053657899

Description

Flexible extraction arm, 60 mm (2.36 in.) diameter, for angled and funnel nozzles. Maximum length 1 m (39.37 in.), ESD safe.

0053658099

ESD Microscope Extraction arm, 32 mm
Extraction arm for sloped and funnel nozzles with perfect flexible for lack and inaccessible space applications, as microscopes and fine soldering works.

ANGLED NOZZLE



Order No.

0053657799

Description

WF 60 angled nozzle for flexible and articulated extraction arm.

FUNNEL NOZZLE



Order No.

0053657399

Description

WF funnel nozzle 60, for flexible and articulated extraction arm, 230 mm x 100 mm.

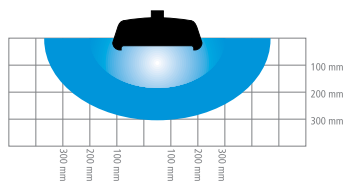

EXHAUST HOOD



Order No.

0058735845

Description

Exhaust hood, 200 x 100 mm (7.87 x 3.93 in.), recommended for use with hot air soldering operations; uses extraction hose 60 with adapter (Order No. 0058762753)

EXTRACTION PLATE



Order No.

0053638099

Description

WFDD 50 Extraction plate with 1 m (39.37 in.) flexible hose, 300 x 210 mm (11.81 x 8.26 in.), for adhesive and solvent fume extraction. ESD safe.



ACCESSORIES

TO BUILD YOUR OWN CUSTOM SOLUTION

STOP VALVE



Order No.

0053657499

Description

WFV 60 Stop valve. Table connector for 60 mm (2.36 in.) flex arm and extraction tube including air flow valve.

MOUNTING CLAMPS



Order No.

0053657599

Description

Bench mounting clamps. Maximum width of clamp 100 mm (3.93 in.). 100 mm (3.93 in.) diameter. Metal.

ADAPTERS



Order No.

0058762750

Description

60/50 Adapter for applications using the 60 mm (2.36 in.) extraction system connected to the former 50WFTB and WFFMP50.



Order No.

0058762753

Adapter with Silicone O-ring, 50 mm (1.96 in.) diameter. Seal for 60 mm (2.36 in.) flex arm mounted directly on WFE 2S and WFE 2ES.

ACCESSORIES FOR WFE2X



Order No.

0053659199

Description

Hanging device for table mounting for fume extraction unit WFE 2X.



Order No.

0053659299

Trolley for fume extraction unit WFE 2X.

EXHAUST ACCESSORIES



Order No.	Description
0058735920	Exhaust adapter of pipe 100 for fume extraction unit WFE 20D.
0058735840	Exhaust adapter of pipe 100 for fume extraction unit WFE 4S.
0058735915	Exhaust adapter of pipe 75 for fume extraction unit WFE 2S.

REMOTE CONTROLS & CABLE



Order No.	Description
0058735909	Remote control for fume extraction units WFE 20D, WFE 2S, WFE 4S and WFE 8S. Switching unit on/off, speed setting (only WFE 2S / WFE 4S), filter status display
0053119199	Interface cable RS 232, 2 m (78.74 in.) for remote monitoring by PC (type 1:1).
0053659399	Remote control for WFE2X

REPLACEMENT FILTERS

Order No.	Filters for WFE 8S
0053659499	Replacement pre-filter
0053659599	Replacement compact filter consists of: HEPA filter H13, wide band gas filter (50% active carbon, 50% Chemabsorb)
Order No.	Filter for WFE 2X:
0053659099	Replacement compact filter consists of: HEPA filter H13, wide band gas filter (50% active carbon, 50% Chemabsorb)
Order No.	Filters for WFE 4S
0058735837	Fine dust filter F5 (10 pieces)
0058735836	Fine dust filter F7 (10 pieces)
0058735838	Compact filter consists of: HEPA filter H13, wide band gas filter (50% active carbon, 50% Chemabsorb)
0058735835	Option: Adhesive fume filter (50% active carbon, 50% Chemabsorb)
Order No.	Filters for WFE 2S
0058735884	Fine dust filter F5 (10 pieces)
0058735885	Fine dust filter F7 (10 pieces)
0058735883	Compact filter consists of: HEPA filter H13, wide band gas filter (50% active carbon, 50% Chemabsorb)
0058735895	Option: Adhesive fume filter (50% active carbon, 50% Chemabsorb)
Order No.	Filter for WFE 2ES:
0058735884	Fine dust filter F5 (10 pieces)
0058762701	Compact filter consists of: HEPA filter H12, wide band gas filter (10% active carbonate foam)
Order No.	Filter for Pre-Filter Box:
0058735860	F7 fine dust filter for large quantities of dust
0058735924	Filter for fine dust or large volumes of liquid flux and adhesives



WFE2P

TWO OPERATOR FUME EXTRACTOR

THE WELLER ADVANTAGE:

This compact, self-contained unit supports up to two FE tip extraction soldering irons on line voltage and has its own internal vacuum pump, so no external power or air is needed. It's perfect for work areas where space is limited.



ESD safe



low sound level



Efficient four-stage filter station is easily replaceable

FEATURES AND BENEFITS:

- Self-contained bench-top unit – no external air source required
- Small footprint and compact size for space savings and portability
- For use with up to two Weller FE series fume extraction soldering irons

WFE2P Includes:

- WFE 2P Fume Extraction Unit
- Compact filter consists of: HEPA filter H13 (Order No. 0053641099), wide band gas filter (50% active carbon, 50% chemical absorbent)
- Fine dust filter F7 (Order No. 0053642199)
- Filters must be ordered separately (see page 57)

WFE2P Components and Specifications:

Operating Voltage	120 V / 60Hz
Operator Capacity	1 - 2 Weller FE series irons
Weight	10 lb. 12 oz. (4.9 kg)
Dimensions	5.5 in. diameter x 11.375 in. (140 x 289 mm)
Noise Level	< 45 db (A) at 1 m distance
Power Input	60 W
Order No. 120V	0053623299

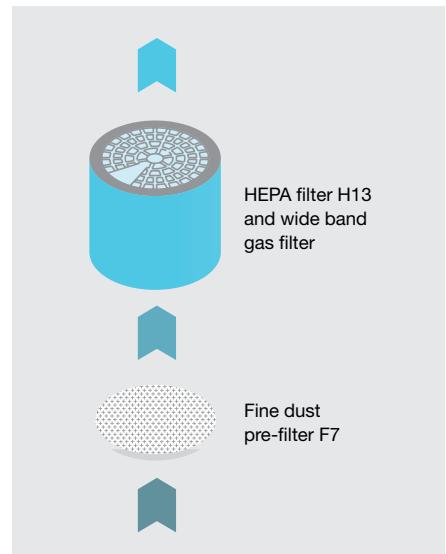

WFE20D

FUME
EXTRACTION

**MOBILE, POWERFUL, ELECTRONICALLY DRIVEN
FUME EXTRACTION UNIT**

THE WELLER ADVANTAGE:

With power to support up to 20 FE tip extraction soldering irons (with the optional Pipe System 50), a choice of two operating modes, and the ability to pre-specify filter change intervals, the WFE20D is a production workhorse.



ESD safe



low sound
level



FEATURES AND BENEFITS:

- Up to 20 FE soldering irons can be connected (With optional Pipe System 50)
- Electrically driven, maintenance free turbine produces the required vacuum
- Four wheels allow easy movement of the unit
- Mobile unit for central and stand alone applications
- Central installation for pipe systems up to 200 m
- Two operating modes: Vacuum can be regulated to 12,000 Pa or variably set between 20% and 100% of maximum power
- RS 232 interface for remote monitoring or remote control
- Electronic filter check automatically switches unit off if specified degree of contamination is exceeded
- LED filter status display alerts operator in advance, allowing filter-change to be scheduled to avoid downtime

WFE20D Includes:

- WFE20D Fume Extraction Unit
- Compact filter consists of: HEPA filter H13, wide band gas filter (50% active carbon, 50% chemical absorbent) (Order No. 0058735838)
- Fine dust filter F7 (Order No. 0058735836)
- Filters must be ordered separately (see page 57)

WFE20D Components and Specifications:

Maximum capacity	20 FE soldering irons
Sound level	< 51 db (A) at 1 m distance
Operating voltage	120 V / 60 Hz
Power input	630 VA
Maximum vacuum	12,000 Pa
Max. delivery rate	100 m ³ /h
Dimension (L x W x H)	450 x 450 x 695 mm 17.7 x 17.7 x 27.3 in
Weight	45 kg / 99 lb.
Order No.	WFE20D



FE75

INTEGRAL FUME EXTRACTION IRON / 80 WATTS

- Fume extraction soldering pencil, 80 watts
- Compatible with any WRS rework system, and WD series soldering stations
- Includes a 5 mm cylinder brush and a funnel for support when not in use
- Uses LT series tips found on page 5
- Order No. 0052916699
- Support stand AK20 (Order No. 0051503099)



ESD safe



FE ATTACHMENTS



Order No.	Description
0052918699	FE Attachment with tube, 6 mm (0.23 in.) for WP120, WSP80, WP80, WMP.
0052918599	FE Attachment with tube, 4.5 mm (0.17 in.) for WP 120, WMRP and WSP 80, WP 80, WMP for fine soldering applications.
0058744875	FE Spare Clip-Set for FE attachment, tube 4.5 mm (0.17 in.).
0058744876	FE Spare Clip-Set for FE attachment, tube 6.0 mm (0.23 in.).
0051515699	WDH 50 safety rest for soldering iron with FE attachment.
0052512599	FE Attachment for LR 21, WSP150 with safety rest AK1.

ACCESSORIES



Order No.	Description
0052541000	Extraction hose (spare part). Heat-resistant silicone hose, 5 mm (0.19 in.), for all FE (Fume Extraction) soldering irons (sold by the meter). (shown)
0052918599	AKFE11 Fume extraction adapter kit (Macro Kit) for W100PG, WP25, WP30, WP35, W60P, TC201T irons. For use with Weller® Fumex® system. Complete with plastic ESD tubing. (shown)

SAFETY REST



Order No.	Description
0051503099	AK 20 Safety rest for FE 75

CORD SUPPORT



Order No.	Description
	Cord support. The cord support keeps the soldering iron cord out of the direct working area. This allows easier handling of the soldering iron.(shown)
0051506599	Cord support for safety rest AK 20.
0051506699	Cord support for safety rest KH 20/23.



ACCESSORIES

FUME
EXTRACTION

FOR WORKBENCH INSTALLATIONS

EXTRACTION HOSES



Order No.

0053631699

Description

Extraction hose 40, 1 m (39.37 in.), 40 mm (1.5 in.). Complete with 2 hose connectors for direct connection of unit (WFE 20D) to pipe system 50. Flexible grey/black plastic.



Order No.

0053641400

Extraction hose 40, 40 mm (1.5 in.) without hose connectors. Sold by the meter. Flexible grey/black plastic.

HOSE CONNECTOR



Order No.

0053641599

Description

Hose connector 40 – 50 for connecting extraction hose 40 and pipe system 50. Black rubber.

EXTENSION HOSE



Order No.

0053632699

Description

Extension hose DN 17 mm OD (13 mm ID) x 5 M length / 0.67" OD (0.51" ID) x 16.4' length. Used where the fume extraction iron is further than 2.5 m (8.2' ft.) from the pipe system 50. Note: Connection nipple for hose 17 and adapter 17 will be required. Clear plastic.

CONNECTION NIPPLES



Order No.

0058735865

Description

Connection nipple for extension hose 17.

0058735866

Nut G 3/8" for connection nipple. (Not Shown)

0053634399

Adapter 17 for connection extension hose DN 17 with 5 mm (0.19 in.) extension hose on FE irons.

0053633899

Connection nipple for 5 mm (0.19 in.) diameter extraction hose to connect FE soldering irons directly to pipe system 50. The connection nipple may be screwed into the pipe system at any point.

REPLACEMENT FILTERS

Order No.

0058735837

0058735836

0058735838

Filters for WFE 20D

Fine dust filter F5

Fine dust filter F7

Compact filter consists of: HEPA filter H13, wide band gas filter (50% active carbon, 50% chemical absorbent)

Order No.

0053641099

0053640799

0053642199

0053659799

Filters for WFE 2P

Compact filter consists of: HEPA filter H13, wide band gas filter (50% active carbon, 50% chemical absorbent)

Compact filter consists of: HEPA filter H13, wide band gas filter (100% active carbon)

Fine dust filter F7 (3 pieces)

Compact filter with enlarged pre-filter



INSTALLATION OPTIONS

INSTALLATION OPTION FOR A CENTRAL SYSTEM WITH WFE 2P

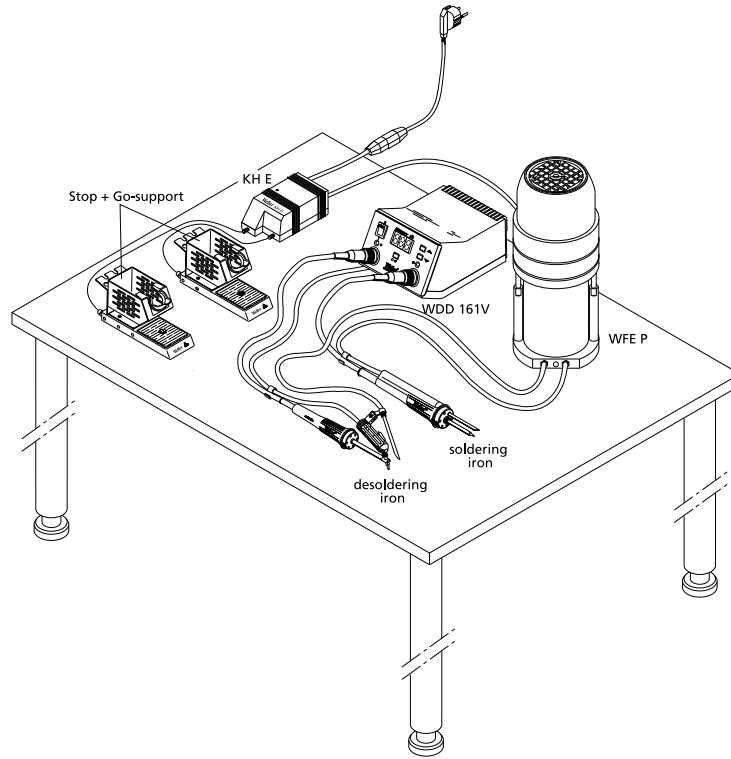

INSTALLATION OPTION FOR A CENTRAL AND STAND ALONE SYSTEM WITH WFE 20D

central system

stand alone system with pipe system 50

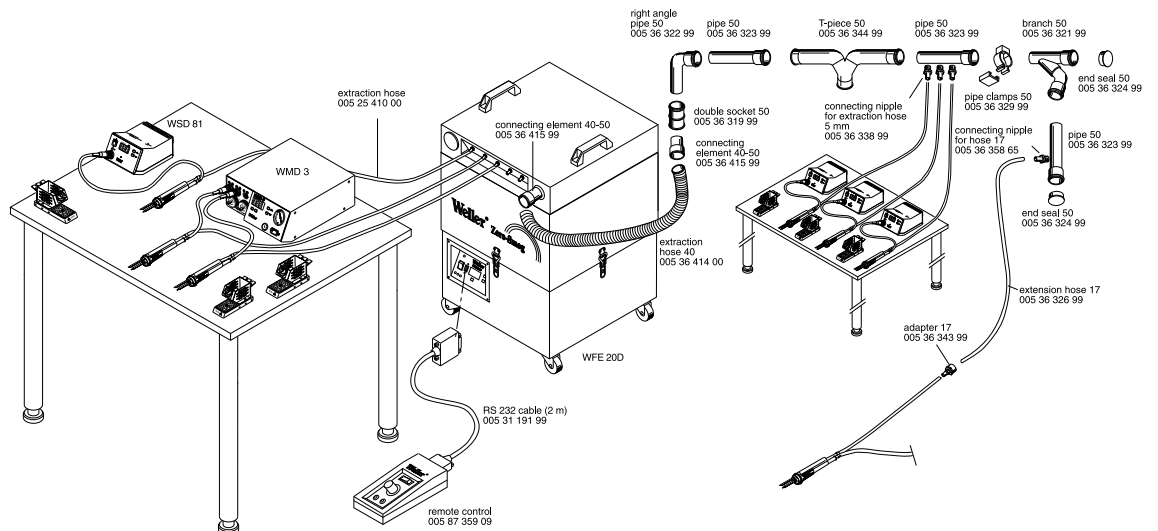

PIPE SYSTEMS

FOR TIP AND VOLUME EXTRACTION

PIPE SYSTEM 50 TIP EXTRACTION

Tip extraction systems demand a high quality, constant level of vacuum across the installation. To achieve this it is necessary to use a pipe system with a relatively small diameter. The Weller pipe system 50 allows extraction installations of up to 200 m when used with the WFE 20D unit in a stand-alone system. The pipe sections are designed to join together and have internal seals. In a central system, the FE soldering irons are connected directly to the fume extraction units.

PIPE SYSTEM 75 VOLUME EXTRACTION

Volume extraction systems require a large volume of air to be extracted and the level of vacuum is of lesser importance. This means that a relatively large diameter pipe system is required. If the pipe diameter is too small the flow resistance is increased and extraction capacity reduced. The pipe system 75 allows installations up to 30 m with the WFE 4S used in a stand alone system. The pipe sections are designed to join together and have internal seals.

PIPE	Order No. Pipe System 50	Order No. Pipe System 75	Description
	0053632399	0058735870	Pipe, 2 m (78.74 in), with seal at one end. Black PEHD*.
RIGHT ANGLE PIPE	Order No. Pipe System 50	Order No. Pipe System 75	Description
	0053632299	0058735869	Right angle pipe, 90°, 0.2 m (7.87 in), with seal at one end. Black PEHD*.
T-PIECE	Order No. Pipe System 50	Order No. Pipe System 75	Description
	0053634499	0058735871	T-piece, 2 x 90°, 0.5 m (19.68 in), with 3 seals. Black PEHD*.
BRANCH	Order No. Pipe System 50	Order No. Pipe System 75	Description
	0053632199	—	Branch, 2 x 45°, 0.3 m (11.81 in), with 2 seals. Black PEHD*.
DOUBLE SOCKET	Order No. Pipe System 50	Order No. Pipe System 75	Description
	0053631999	—	Double socket. Black PEHD*.
END SEAL	Order No. Pipe System 50	Order No. Pipe System 75	Description
	0053632499	0058735855	End seal. Clear plastic.
PIPE CLAMPS	Order No. Pipe System 50	Order No. Pipe System 75	Description
	0053632999	0058735864	Pipe clamps for pipes, (for securing to wall). Gray plastic.
ADAPTERS	Order No. Pipe System 50	Order No. Pipe System 75	Description
	—	0058735863	Adapter pipe system 75 to pipe system 50 with seals.
	—	0058735856	Adapter PEHD* pipe system 75 to pipe system 50, without seals.

*PEHD = Polyethylene High Density



WSA350

BENCHTOP SMOKE ABSORBER

THE WELLER ADVANTAGE:

The WSA350 removes flux fumes from the benchtop by drawing the smoke through an activated carbon filter. Powered by an exceptionally quiet fan, the WSA350 can process up to 1.37 cubic meters of air per minute. The collector can be easily adjusted to multiple positions, optimizing its fume-absorbent performance.



FEATURES AND BENEFITS:

- Removes flux fumes from soldering workbench
- Great for workspaces using more active fluxes used with lead-free solder
- Fumes are absorbed by the replaceable carbon-activated filter
- Includes one replaceable filter
- Stand allows the smoke absorber to be adjusted to varying angles
- Fan is quiet and will not add significant noise to the workspace
- ESD safe
- Package of 3 replacement filters. Part No. WSA350F

WSA350 Specifications:

Voltage	120 Vac
Air Consumption	87-107 CFM
Sound Level	45-50 dB (A)
Power Consumption	20W
Absorption Capacity	1.25 m ³ /min. (50 Hz) to 1.37 m ³ /min. (60 Hz)
ESD Safe	Yes
UL and cUL Listed	Yes

WSA350F Specifications:

Filters per pack	3
Size	130mm x 130mm x 10mm
Activated carbon content per filter	9g
Maximum capacity for noxious components per filter	2.5g

PROFESSIONAL

SOLDERING IRONS / 25 WATT / 30 WATT / 35 WATT

- Ideal for a wide variety of electronic tasks
- Uses ST series long life double-coated iron-plated tips- ST3 included-see page 37
- Quick change knurled collar, stainless steel barrel
- Cushion grip handle and plug-in heating element
- 6' 3-wire cord, iron is 7 7/8" long
- UL and cUL listed (120 VAC units only)
- Use with optional PH60 stand



WP25

Catalog Number

WP25
WP30
WP35

Description

25 watts, 120 V, 750° F Professional soldering iron, 3-wire cord
30 watts, 120 V, 800° F Professional soldering iron, 3-wire cord
35 watts, 120 V, 850° F Professional soldering iron, 3-wire cord

CONTROLLED OUTPUT

SOLDERING IRONS / 60 WATT / 100 WATT

- Uses Weller "closed loop" method of controlling maximum tip temperature
- Portable line voltage iron - no base station required
- Stainless steel modular plug-in heater, greater efficiency and versatility
- Temperature is controlled by tip (600° F, 700° F, and 800° F tips)
- Nominal heat-up time with 700° F tip is 110 seconds
- Uses CT series tips found on page 62
- Heating element type: Nichrome wound, plug in
- UL and cUL listed
- Fume extraction adapter kit available- Cat. No. AKFE11
- Use W60P with optional PH60 stand
- Use W100P with optional PH100 stand



W60P



W100PG

Catalog Number

W60P
W60P3
W100PG
W100P3

Description

60 watts, 120 V, 700° F 2-wire soldering iron with CT5A7 tip
60 watts, 120 V, 700° F 3-wire soldering iron with CT5A7 tip
100 watts, 120 V, 700° F heavy duty 3-wire soldering iron with CT6F7 tip
100 watts, 120 V, 700° F heavy duty 3-wire soldering iron with CT6F7 tip

TCP12P

CONTROLLED-OUTPUT FIELD SOLDERING IRON

- Versatile controlled tool for field servicing
- Operates from 12 volt batteries or low voltage power source
- Complete with battery clips and 12' fused cord
- Soldering iron comes with PTA7 tip, creates 700° F temperature
- See page 25 for replacement tip selection



TIPS

**ST SERIES TIPS FOR WP25 / WP30 / WP35 IRONS
TINNED WITH LEAD FREE SOLDER**

SCREWDRIVER

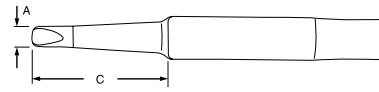

Cat No.	A		C	
	IN.	MM	IN.	MM
ST1	0.062	1.58	0.75	19.05
ST2	0.093	2.38	0.75	19.05
ST3	0.125	3.17	0.75	19.05
ST4	0.187	4.74	0.75	19.05
ST6	0.031	0.79	0.75	19.05
ST8	0.062	1.58	0.75	19.05

SINGLE FLAT

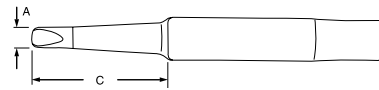

Cat No.	A		C	
	IN.	MM	IN.	MM
ST5	0.031	0.79	0.75	19.05

CONICAL

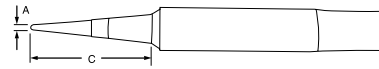

Cat No.	A		C	
	IN.	MM	IN.	MM
ST7	0.031	0.79	0.75	19.05

TIPS

**CT SERIES TIPS FOR W60P AND W100P IRONS AND WLC100 STATION
TINNED WITH LEAD FREE SOLDER**

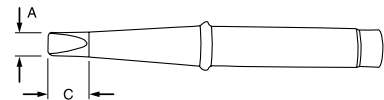
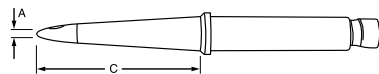

CT5 SERIES SCREWDRIVER

CT6 SERIES SCREWDRIVER

600° F Cat. No.	700° F Cat. No.	800° F Cat. No.	900° F Cat. No.	FITS IRON	A		C	
					IN.	MM	IN.	MM
-	CT5A7	CT5A8	-	W60P	0.062	1.58	1.15	29.36
-	-	CT5B8	-	W60P	0.093	2.38	1.15	29.36
-	CT5C7	CT5C8	-	W60P	0.125	3.17	1.15	29.36
-	CT5D7	CT5D8	-	W60P	0.187	4.74	1.15	29.36
-	CT5E7	CT5E8	-	W60P	0.250	6.35	1.15	29.36
CT6C6	CT6C7	CT6C8	-	W100P	0.125	3.17	1.37	34.92
CT6D6	CT6D7	CT6D8	-	W100P	0.187	4.74	1.37	34.92
CT6E6	CT6E7	CT6E8	-	W100P	0.250	6.35	1.37	34.92
CT6F6	CT6F7	CT6F8	CT6F9	W100P	0.375	9.52	1.37	34.92
-	CT6G7	-	-	W100P	-	-	1.37	34.92

WM120

THIN SOLDERING IRON / 12 WATT



- Lightweight, pencil thin soldering iron with stay-cool handle
- Designed for soldering miniature components
- Develops tip temperature of 800° F
- 3-wire grounded plug
- Uses Weller MP series auto slide-in tips
- UL listed

TIPS TINNED WITH LEAD FREE SOLDER

CONICAL		Cat No.	A		C	
			IN.	MM	IN.	MM
		MP131	0.015	0.39	0.43	11.09
SINGLE FLAT		Cat No.	A		C	
			IN.	MM	IN.	MM
		MP133	0.031	0.79	0.43	11.09

STANDARD SERIES

MODULAR SOLDERING IRONS

- Modular soldering irons utilize interchangeable handles, heaters and tips
- 3-wire grounded
- Uses 9800 iron holder
- UL and cUL listed
- Tips on page 65



SL325

Catalog Number	Description
SL325	Modular soldering iron with 7400 handle, 537S heater, PL111 tip
SL335	Modular soldering iron with 7400 handle, 1237S heater, PL113 tip
SL345	Modular soldering iron with 7400 handle, 4037S heater, PL133 tip
SL500	Modular soldering iron with 7760 handle, 37UG heater, PL133 tip

HANDLES

STANDARD SERIES MODULAR SOLDERING IRON HANDLES

- Modular soldering irons utilize interchangeable handles
- Interchangeable heaters and tips for custom applications and maintenance
- Iron has 5' cord
- Feature cool, "soft touch", acid and flux resistant grips
- Uses 9800 iron holder
- UL and cUL listed
- 7400 and 7500 handle for SL325, SL335, SL345 and SL500 are 3-wire grounded
- 7760 handle (red) and 7770 handle (blue) is 2-wire ungrounded



7400

Catalog Number	Description
7400	Standard Series modular iron handle, 3-wire standard cord
7500	Standard Series modular iron handle, 3-wire burn resistant cord
7770	Standard Series modular iron handle (Blue), 2-wire standard cord
7760	Standard Series modular iron handle (Red), 2-wire standard cord



MODULAR HEATERS

WITH INTEGRAL TIP

- Used with Standard Series modular irons
SL325, SL335, SL345 and SL500 and Standard
Series Handles 7400, 7500, 7760, and 7770

Catalog Number

33
533S
1233S
4033S
4039S

Description

Modular heater with long chisel tip, 50 watt, 1100° F
Modular heater with long chisel tip, 23 watt, 800° F
Modular heater with integral long chisel tip, 33 watt, 900° F
Modular heater with long chisel tip, 45 watt, 1000° F
Modular heater with short chisel tip, 45 watt, 1100° F



MODULAR HEATERS

FOR THREAD-IN AND THREAD-ON TIPS

- Used with Standard Series modular irons
SL325, SL335, SL345 and SL500 and Standard
Series Handles 7400, 7500, 7760, and 7770
- Tips on page 65

THREAD-IN TIPS

Catalog Number

535S
1235S
4035S

Description

Modular heater thread-in tip, 23 watt, 700° F
Modular heater thread-in tip, 33 watt, 800° F
Modular heater thread-in tip, 45 watt, 900° F

THREAD-ON TIPS

Catalog Number

37UG
537S
1237S
4037S

Description

Modular heater uses thread-on tip, 50 watt, 1000° F
Modular heater thread-on tip, 23 watt, 700° F
Modular heater thread-on tip, 33 watt, 800° F
Modular heater thread-on tip, 45 watt, 900° F



HANDLES

DOUBLE INSULATED MODULAR SOLDERING IRON HANDLE

- Bio-mechanical handle design
- Has flexible heat-resistant, double insulated (9') 2-wire cord set
- Soft touch cool, molded grip for operator comfort and control
- Twice the dielectric values of standard UL requirements



555XT

MODULAR HEATERS

FOR DOUBLE INSULATED HANDLE

- Used with DI (double insulated) series
555XT two-wire handle

Catalog Number

360
362
363

Description

Modular heater uses thread-on tip, 27 watt, 700° F
Modular heater uses thread-on tip, 45 watt, 900° F
Modular heater uses integral chisel tip, 45 watt, 1000° F



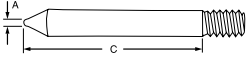
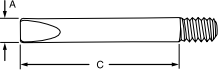
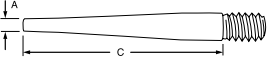

TIPS

**PL SERIES THREAD-IN STYLE TIPS FOR MODULAR HEATERS
TINNED WITH LEAD FREE SOLDER**

	Cat No.	Type	A		C	
			IN.	MM	IN.	MM
PENCIL						
	100UG PL331	Adapter Plated	-- 0.01	-- 0.25	-- 0.85	-- 21.59
CHISEL						
	PL333 333 7155	Plated Bare Copper Plated	0.13 0.12 0.06	3.30 3.04 1.52	0.85 0.85 0.84	21.59 21.59 21.33
TAPERED NEEDLE						
	PL338	Plated	0.05	1.27	0.94	23.87

TIPS

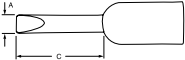
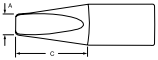
**PL SERIES THREAD-ON STYLE TIPS FOR MODULAR HEATERS
TINNED WITH LEAD FREE SOLDER**

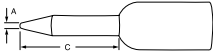
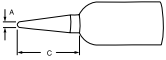
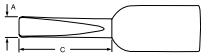
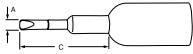
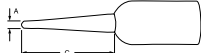
	Cat No.	Type	A		C	
			IN.	MM	IN.	MM
CHISEL						
	PL113 PL153 PL350	Plated Plated Plated	0.13 0.20 0.40	3.30 5.08 10.14	0.66 0.56 --	16.76 14.22 --
LONG TAPER CHISEL						
	PL133	Plated	0.20	5.08	0.56	14.22
MICRO SPADE						
	PL114	Plated	0.05	1.27	0.41	10.41
PENCIL						
	PL111 PL153	Plated Bare Copper	0.03 0.02	0.76 0.50	0.66 0.66	16.76 16.76
PRECISION						
	PL100	Plated	0.05	1.27	0.45	11.43
SCREWDRIVER						
	PL151	Plated	0.13	3.30	0.66	16.76
STEPPED CHISEL						
	PL155	Plated	0.07	1.77	0.66	16.76
TAPERED NEEDLE						
	PL138	Plated	0.05	1.27	0.66	16.76



PORTASOL® PSI100C

SUPER-PRO SELF-IGNITING CORDLESS BUTANE SOLDERING IRON AND KIT

- Self-igniting portable butane heat tool - professional quality
- Ideal for service technicians
- For uses such as anti-static soldering, heat shrink and cutting rope
- Features “Auto Switch” safety shut-off, and iron plated tips
- Butane fuel level is visible through a window on the body of the tool
- Rugged stainless-steel body
- Provides up to 125 watts of power
- Adjustable temperature up to 1,076° F
- Operates up to 2 hours per refill
- Refills with butane fuel - Weller® cat no. WB1 or WB2



PSI100C

Portasol® is a registered trademark of Olgesby and Butler Limited

PSI100K KIT

Complete kit contains: PSI100C iron with PSI1 tip, PSI3 tip, PSI9 tip, PSI10 tip, sponge, case



PSI100K

PSI SERIES TIPS FOR PSI100C AND PSI100K SOLDERING TOOLS

	Cat No.	A		C	
		IN.	MM	IN.	MM
SINGLE FLAT 	PSI1	0.031	0.79	0.640	16.26
	PSI2	0.093	2.36	0.640	16.26
	PSI3	0.125	3.18	0.640	16.26
	PSI4	0.187	4.75	0.420	10.67
DOUBLE FLAT 	PSI5	0.031	0.79	0.680	12.27
	PSI6	0.093	2.36	0.680	12.27
	PSI7	0.125	3.18	0.680	12.27
	PSI8	0.187	4.75	0.680	12.27
HOT AIR 	Cat No.	IN.	MM	IN.	MM
	PSI9	0.230	5.84	0.240	6.10
KNIFE 	Cat No.	IN.	MM	IN.	MM
	PSI10	0.195	4.95	1.485	37.62

PORTASOL® P2C

SELF-IGNITING CORDLESS BUTANE SOLDERING IRON AND KIT

- A lightweight, compact cordless butane soldering and hot air tool
- Piezo ignition with push-button ease & convenience, 25 watts to 75 watts
- Fast heat-up for high productivity, melts solder in less than 40 seconds
- Gas capacity allows up to 1 hour of continuous use
- Refills in less than 20 seconds so you can stay on the job
- Automatic cut-off switch when cap replaced for safety
- Can be used as a mini-torch with flame tip
- Refills with butane fuel - Weller® cat no. WB1 or WB2

Portasol® is a registered trademark of Olgesby and Butler Limited



P2C



P2KC

P2KC KIT

Complete Iron and Hot Air Tool kit contains; P2C iron with soldering tip, mini blow torch tip, hot knife tip, hot air tip and deflector, sponge and tray, storage case with tool holder, and instructions

PPT SERIES TIPS FOR P2C AND P2KC SOLDERING TOOLS

SINGLE FLAT

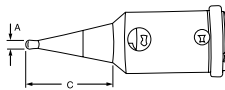

Cat No.	A		C	
	IN.	MM	IN.	MM
PPT1	0.031	0.79	0.460	11.68
PPT2	0.093	2.36	0.460	11.68

DOUBLE FLAT

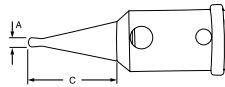

Cat No.	A		C	
	IN.	MM	IN.	MM
PPT5	0.031	0.79	0.460	11.68
PPT6	0.093	2.36	0.460	11.68

PREMIUM BUTANE FUEL

- Premium quality butane fuel
- Compatible with Weller® Portasol® and Weller® Pyropen® tools
- Printed in English and Spanish with operating instructions on back of can

Catalog Number	Description
WB1	Premium butane fuel, 2.1 oz.
WB2	Premium butane fuel, 1.0 oz.



CORDLESS
SOLDERING
IRONS

WPA2 PYROPEN® PROFESSIONAL SELF-IGNITING CORDLESS BUTANE SOLDERING IRON

- Ignites with the push of a button, ideal for field service jobs
- Lightweight and completely portable, ready to use in 30 seconds
- Sturdy metal tank holds enough butane gas for 3 hours of operation
- Temperature adjusts from 482° F to 932° F
- Refills with butane fuel - Weller® Cat. No. WB1 or WB2



HOT AIR TIPS

Cat No.	Width		Reach	
	IN.	MM	IN.	MM
WHC51	0.17	4.27	0.24	6.10
WHC52	0.19	4.91	0.24	6.10

SPADE 35°

Cat No.	Width		Reach	
	IN.	MM	IN.	MM
WPT8	0.08	2.00	0.65	16.51

CHISEL TIPS

Cat No.	Width		Reach	
	IN.	MM	IN.	MM
WPT2	0.08	2.00	0.72	18.29
WPT11	0.32	8.00	0.55	14.00
WPT13	0.20	5.00	0.55	14.00

TAPER NEEDLE TIPS

Cat No.	Width		Reach	
	IN.	MM	IN.	MM
WPT1	0.04	1.00	0.75	19.05
WPT5	0.04	1.00	0.72	18.29

WST2 PYROPEN® JUNIOR CORDLESS BUTANE SOLDERING IRON

- Lightweight mini iron
- Dual function soldering iron and brazing torch
- Soldering iron: 392° F - 842° F; Hot blow feature: 806° F maximum
- Torch feature: 2372° F maximum
- Includes soldering and hot air tips
- Refills with butane fuel - Weller® cat. no. WB1 or WB2



TAPER NEEDLE TIP

Cat No.	Width		Reach	
	IN.	MM	IN.	MM
WPT15	0.02	0.51	0.55	14.00

HOT AIR TIP

Cat No.	Width		Reach	
	IN.	MM	IN.	MM
WHC54	0.06	1.50	--	--

WSTA3 PROFESSIONAL CORDLESS BUTANE SOLDERING IRON

- Lightweight and completely portable
- Ready to use in 30 seconds
- Ideal for field service jobs
- Sturdy metal tank holds enough gas for three hours of operation
- Temperature adjusts from 392° F - 932° F
- Refills with butane lighter gas - Weller® cat. no. WB1 or WB2



NOTE: For tips used on this tool, please refer to the WPA2 tool at the top of this page.

WSTA6 JUNIOR CORDLESS BUTANE SOLDERING IRON

- Self-ignition finger switch - no sparklighter required
- Temperature control gives you adjustment equivalent to 15 to 60 watts
- Tank can hold enough gas for one hour of operation
- 30 second heat-up time
- Includes soldering and hot air tips
- Refills with butane lighter gas - Weller® cat. no. WB1 or WB2



TAPER NEEDLE TIP

Cat No.	Width		Reach	
	IN.	MM	IN.	MM
WPT01	0.04	1.00	0.55	14.00

6966C LIGHTWEIGHT HEAT GUN 250 WATTS / 120 VOLTS

THE WELLER ADVANTAGE:

Weighing in at less than a pound, this ESD safe heat gun is perfect for repetitive or continuous use in production plants, labs, and electronics service facilities.

FEATURES AND BENEFITS:

- Heavy duty heater and fan components for long service life
- Light weight for reduced operator fatigue
- Perfect for shrink tubing and vinyl/T.F.E., epoxy curing, drying, and cooling

6966C Components & Specifications

Weight	13 oz. (.368 kg)
Voltage	120 V 50/60 Hz
Power Consumption	250 W
Temperature Range	750° F – 800° F (399° C – 427° C)
ESD Safe	Yes
Cord Type	Three-wire grounded
Cord Length	6 ft. (1.8 m)
UL and cUL Listed	Yes



6966C ACCESSORIES

Catalog Number	Description
6956	Reflector (.50")
6957	Reflector (1.50")
6958	Reducing Baffle
6964	Precision Reflector, 0.20"
6965A	Heat Gun Wire Stand
6959	Adapter for 6966C baffles for use with 1095 Gun



1095 STANDARD DUTY HEAT GUN / 1000 WATTS

- Dual temperature, economical heat gun, ideal for most heat gun applications
- Applying heat shrinking products
- Curing epoxy and softening adhesives
- Drying, thawing frozen pipes
- Softening and molding plastics
- Heating liquids and stripping paint
- Dual temperature 1200° F (1000 W) and 790° F (400 W); 3-way switch (Hi - Off - Low)
- 3-wire grounded plug 6' power cord
- Lightweight, 22 oz. with cord



1095 ACCESSORIES

Catalog Number	Description
1080	Reducer for concentrating heat
1082	Reflector for heat shrink tubing/caps
1085	Baffle kit containing Reducer, Reflector, Flame Spreader



D550 120V PROFESSIONAL SOLDERING GUN

- Professional heavy-duty, dual-heat gun produces 260 or 200 watts
- Pistol grip design, ready to use in 6 seconds
- Fingertip trigger selects high (1st trigger position)
- Or low output (2nd trigger position)
- Heavy gauge, high efficiency, tin-plated copper tip
- Twin lights illuminate work
- 2-wire cord, UL and cUL listed

Specifications:

Catalog No.	D550
UPC Code	037103475411
Wattage	260 W/200 W
Temperature Range	1100° F/900° F
Cord Length	6 ft.



D650 120V INDUSTRIAL SOLDERING GUN

- Reliable industrial quality tool
- Heavy-duty dual-heat gun produces 300 or 200 watts
- Highest power output of all our soldering guns
- 300 watts in high trigger (1st trigger position)
- 200 watts in low trigger (2nd trigger position)
- Heat-resistant thermoplastic housing, tin-plated copper tip, and heavy-duty grounded cord (3 wire)
- Soldering, cutting and smoothing tips available
- UL and cUL listed

Specifications:

Catalog No.	D650
UPC Code	037103079480
Wattage	300 W/200 W
Temperature Range	1100° F/900° F
Cord Length	6 ft.



GT7A SOLID STATE SOLDERING GUN

- Temperature controlled with fast 6-second heat up
- Lightweight 7 oz./198 g
- Slim long reach barrel
- Interchangeable power heads give choice of 600° F/315° C or 700° F/370° C
- UL and cUL listed
- GT7A3 3-wire version available

Specifications:

Catalog No.	GT7A
UPC Code	037103473202
Wattage	150 W
Temperature Range	700° F
Cord Length	6 ft.

7A Specifications:

Description	700° Power Head with 3/16" Chisel tip
UPC Code	037103473196

6B Specifications:

Description	600° Power Head with 1/8" Cone tip
UPC Code	037103472830



7805
SOLDER-OFF DESOLDERING BULB

- Desoldering bulb with T.F.E. tip
- Facilitates accurate printed circuit repair and cleaning
- May be used with soldering iron



FLUX SOLVENT DISPENSERS



- Flux solvent dispenser
- Avoid spills and waste and place flux precisely where needed
- Squeeze bottle dispenses 1 drop of liquid through stainless steel needle
- Dispenses flux, oil and solvent

Catalog Number	Description
FD2	Flux dispenser, 0.020" needle
FD21D	Flux dispenser, 0.008" needle, ESD Safe
FD2D	Flux dispenser, 0.020" needle, ESD Safe
FD3	Flux dispenser, Tri-Tip

SCRUB-IT™ SOLVENT DISPENSERS

- Distributes solvent through a nylon brush
- For cleaning printed circuit boards and other connections
- No mess, no waste
- Dispenser holds 2 oz.

Catalog Number	Description
SD74	Scrub-it dispenser, nylon bristles
SD74H	Scrub-it dispenser, horse hair bristles, ESD Safe

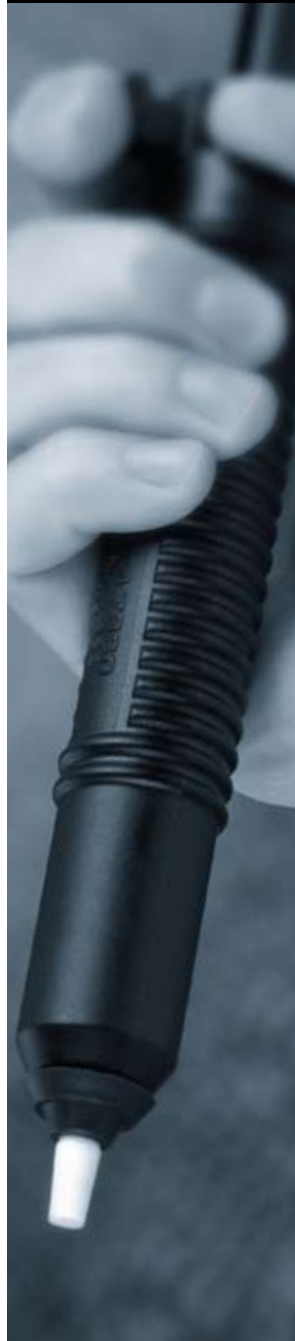

WA2000
SOLDERING IRON ANALYZER

- The Weller WA2000 measures temperature stability or absolute temperature in degrees Fahrenheit or Celsius
- Portable unit with long battery life
- The Weller CP01 Contact Pyrometer (included) can be used to quickly measure the temperature Stability of a soldering iron tip
- Temperature Accuracy on Weller soldering stations can be performed using optional Thermocoupled Tip Assemblies offered by Weller (see "K" Series accessories below)
- Soldering Iron Tip to Ground Resistance measurements may be performed using the unique Patented circuitry of the Weller Model WA2000
- Performs soldering iron Tip to Ground Millivolt potential measurements (mVAC - TRMS)



Soldering iron not included

CP01
20 GA. CONTACT PYROMETER

- Used with the Weller WA2000 analyzer
- Used to monitor temperature stability (see Thermocoupled Tip Assemblies below for Temperature Accuracy measurement of soldering iron tips)



K111
TYPE K THERMOCOUPLE ASSEMBLY WITH ETA TIP

- Thermocoupled Tip Assembly provides accurate temperature measurements of Weller soldering iron tips
- Compatible with EC1201, PES50 and PES51 Series soldering pencils



K1111
TYPE K THERMOCOUPLE ASSEMBLY WITH LTB TIP

- Thermocoupled Tip Assembly provides accurate temperature measurements of Weller soldering iron tips
- Compatible with WP80 soldering pencil



K1121
TYPE K THERMOCOUPLE ASSEMBLY WITH XTB TIP

- Thermocoupled Tip Assembly provides accurate temperature measurements of Weller soldering iron tips
- Compatible with WP120 soldering pencil



K181
TYPE K THERMOCOUPLE ASSEMBLY WITH LTB TIP

- Thermocoupled Tip Assembly provides accurate temperature measurements of Weller soldering iron tips
- Compatible with WSP80 soldering pencil



K191
TYPE K THERMOCOUPLE ASSEMBLY WITH NTB TIP

- Thermocoupled Tip Assembly provides accurate temperature measurements of Weller soldering iron tips
- Compatible with WMP soldering pencil



K1101
TYPE K THERMOCOUPLE ASSEMBLY WITH RT4 TIP

- Thermocoupled Tip Assembly provides accurate temperature measurements of Weller soldering iron tips
- Compatible with WMRP soldering pencil and WSM1 / WSM1C soldering stations



MANUAL DESOLDERING PUMPS

7880 MANUAL DESOLDERING PUMP

- Powerful, heavy-duty, spring-loaded vacuum for complete solder removal
- Design includes cushioned plunger, easy thumb activation and ribbed pencil grip
- Heat resistant Teflon* tips
- Replacement tip: 7882BK

* Teflon is a Registered Trademark of DuPont



7881 MANUAL DESOLDERING PUMP

- Powerful, heavy-duty, spring-loaded vacuum for complete solder removal
- Design includes cushioned plunger, easy thumb activation and ribbed pencil grip
- Constructed of static-dissipative material with surface resistivity of 10^9 ohms/sq. for component protection
- Replacement tip: 7883



7874B MANUAL DESOLDERING PUMP

- One hand operation with spring-loaded piston provides ESD safe, solder removing vacuum
- Self-cleaning, non-clogging, static-free replaceable tip
- Replacement tip: 7875B



**ESF120ESD
CIRCUIT BOARD HOLDER**

- Safely and securely hold circuit boards during soldering and rework applications
- For holding circuit boards up to 160 x 235 mm
- Allows 360 degree rotation in 15 degree increments
- Components are held in place by a cushioned arm
- Order No. 0051502699
- ESD Safe



**WBH2
CIRCUIT BOARD HOLDER**

- Cost effective, ESD safe board holder allows easy retaining and securing of circuit boards for repair up to 260 mm wide.
- The perfect partner to Weller's infrared heating plates for pre-heating circuit boards.
- Compatible with WHP3000, WHP1000 and WHP200 pre-heaters*

*Pre-heaters sold separately

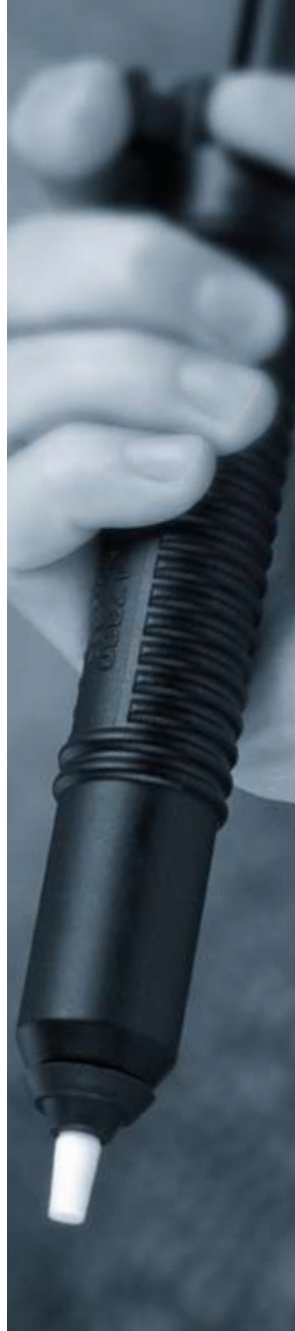

SM 1
SOLDER-MATE™ DISPENSER

- Durable dispenser minimizes core solder usage
- Eliminates operator downtime, provides continuous solder wire
- Holds 1 pound solder spool (solder not included)



WLSK200
VACUUM PICK-UP PEN

- For handling small electronic components
- Pocket clip for portability



WPB 1
TIP POLISHING BAR

- Cleans and renews soldering tips. (Use on cold tips only)
- Removes plastic resins, oxidation, silicone grease and other chemicals from tip.
- Re-tin tip after use to prevent oxidation.



WDC
SOLDERING TIP DRY CLEANER

- Safely cleans soldering tip without thermal shock.
- Cleans tip without water with the use of a special metal wool ball.
- Order No. 0051512499.
Replacement wools- Order No. 0051384099 (2 pack)



WDC2
SOLDERING TIP DRY CLEANER

- Retrofits into WDH10(T), 20(T), 30, 40, and 50 iron stands
- Gentle tip cleaning when used with lead free solder to extend tip life
- Order No. 0051512599
Replacement wools- Order No. 0051382499 (2 pack)



0051303199
LEAD FREE TIP ACTIVATOR

- For regeneration of oxidized tips, works fast and easy with low temperature.
- Environmentally safe, no halides, lead, rosin or residue
- Proper use will prolong lifetime of the tips.



**TC201T
REPLACEMENT SOLDERING PENCIL**

- Use with WTCP series soldering stations - uses PT series tips
- Replacement 42 Watt soldering pencil with PTA7 tip



**TC217
REPLACEMENT CORD**

- Replacement cord assembly for TC201T soldering pencil



**SW60
SWITCH ASSEMBLY**

- Switch assembly for controlled output soldering pencils
- TC201, TCP12P, W60P and W100P series soldering irons
- Fits TC201 series, W60P, W100P series irons



TIP RETAINERS

- WS102 for WSP80
- 0058744845 for WP80 (Short)
- 0058744846 for WP80 (Long)
- BA60 for TC201T, TC201FE, TCP12P, EC1201A, EC1201AFE, PES50, PES51 Soldering Tools



**EC234
HEATER ASSEMBLY**

- Heater assembly for EC1201A and TC201 series soldering irons

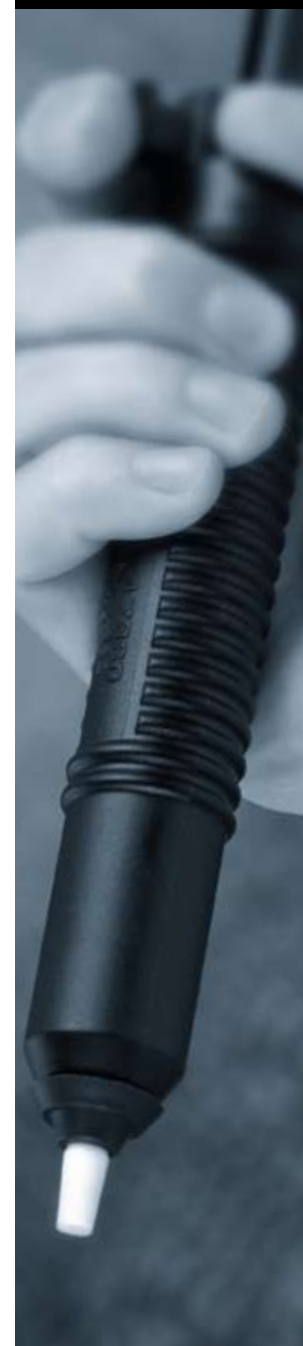

KDS824A

DELUXE SHOT METER

- Digital timer control allows metered shot repeatability
- Shot time duration adjustable from 0.01 to 99.99 seconds
- Adjustable four position push button timer
- Vacuum feature prevents dripping
- Electrically actuated foot pedal
- Accessory port for optional KDS301 vacuum pickup wand (see page 78) or for pressurizing an external cartridge or tank
- Two 0 - 100 PSI regulators and gauges with locking ring
- Low voltage unit for safety
- Slide switch easily changes unit from 115 to 230 volts
- Order syringe adapters, kits and other accessories separately



Controller	KDS824A	
Input Voltage (Switchable)	50 / 60 Hz	50 / 60 Hz
Output Voltage	24v	24v
Air Input/Output	0-100 psi	0-6.9 Bar
Vacuum	0-18" Hg	-0.61 Bar
Footprint	9.5"W x 7.75"D x 5"H	24.1cm x 19.7cm x 12.7cm
Weight	7 lb, 7 oz	16.4 kg
Timer Range	.01 to 99.99 seconds	
Repeat Accuracy	.5 ms (.0005 sec.)	
Recycle Time	12 ms (.012 sec.)	
Setting Accuracy	± 2%	

Catalog No.	UPC No.	Packed	Description	Pack Weight	Pack Quantity
KDS824A	037103173720	Boxed	Deluxe Shot Meter	9.090 lb., 257.5 g	1

KDS834A

STANDARD SHOT METER

- Digital timer control allows metered shot repeatability
- Shot time duration adjustable from 0.01 to 99.99 seconds
- Adjustable four position push button timer
- Vacuum feature prevents dripping
- Electrically actuated foot pedal
- Low voltage unit for safety
- Slide switch easily changes unit from 115 to 230 volts
- Order syringe adapters, kits and other accessories separately



Controller	KDS834A	
Input Voltage (Switchable)	50 / 60 Hz	50 / 60 Hz
Output Voltage	24v	24v
Air Input/Output	0-100 psi	0-6.9 Bar
Vacuum	0-18" Hg	-0.61 Bar
Footprint	6.25"W x 7.75"D x 5"H	15.9cm x 19.7cm x 12.7cm
Weight	5 lb, 10 oz	12.4 kg
Timer Range	.01 to 99.99 seconds	
Repeat Accuracy	.5 ms (.0005 sec.)	
Recycle Time	12 ms (.012 sec.)	
Setting Accuracy	± 2%	

Catalog No.	UPC No.	Packed	Description	Pack Weight	Pack Quantity
KDS834A	037103173744	Boxed	Economy Shot Meter	8.140 lb, 230.6 g	1

KDS808

BASIC SHOT METER

- Basic low cost system
- Easy to set up and operate
- "Eyeball" accuracy
- Electrically actuated foot pedal
- Vacuum feature prevents dripping
- 0 - 100 PSI regulators and gauges with locking ring
- Low voltage unit for safety
- Slide switch easily changes unit from 115 to 230 volts
- Order syringe adapters, kits and other accessories separately



Controller	KDS808	
Input Voltage (Switchable)	115V 50/ 60 Hz	230V 50/60 Hz
Output Voltage	24v	24v
Air Input/Output	0-100 psi	0-6.9 Bar
Vacuum	0-18" Hg	-0.61 Bar
Footprint	5"W x 7.75"D x 5"H	12.7cm x 19.7cm x 12.7cm
Weight	5 lb, 1 oz	11.1 kg

Catalog No.	UPC No.	Packed	Description	Pack Weight	Pack Quantity
KDS808	037103173706	Boxed	Basic Shot Meter	7.340 lb, 207.9 g	1

KDS806(V)

FOOT VALVE

- Basic ON-OFF function
- "Eyeball" accuracy
- Foot actuated for excellent ergonomics
- Works on compressed air input only - no electricity required
- 0 - 100 PSI regulator and gauge
- Easy to set up and operate
- Sits on the floor, thus using no table space
- KDS806V includes drip-free vacuum accessory
- Order syringe adapters, kits and other accessories separately



Controller	KDS806/KDS806(V)	
Air Input/Output	0-100 psi	0-6.9 Bar
Vacuum	0-18" Hg	-0.61 Bar
Footprint - KDS806	3.75"W x 7.25"D x 3.75"H	9.5cm x 18.4cm x 9.5cm
Footprint - KDS806V	3.75"W x 8.5"D x 5"H	9.5cm x 21.6cm x 9.5cm
Weight	3 lb, 5 oz	7.3 kg

Catalog No.	UPC No.	Packed	Description	Pack Weight	Pack Quantity
KDS806	037103173805	Boxed	Foot Valve	4.513 lb, 127.9 g	1
KDS806V	037103173836	Boxed	Foot Valve w/ Vacuum	4.715 lb, 133.6 g	1



DELUXE KIT

FOR SHOT METERS/FOOT VALVES (DISPENSER NOT INCLUDED)

A starter-kit for users who do not know which size syringe will be used or when size requirements change. Kit is available separately or as an option with most shot meters.

Kit contents:

- Four plastic adapter assemblies (3, 5, 10 & 30cc)
- Samples of Luer Lok™ and tapered syringes
- Syringe tip caps
- Needle samples (non-sterile, blunt) in stainless, and plastic tapered tip
- Syringe stand
- Material line filter
- 2-oz. squeeze bottle
- Industrial vinyl gloves



Catalog No.	UPC No.	Packed	Description	Pack Weight	Pack Quantity
KDSDELUXEKIT	037103174451	Boxed	Deluxe Starter Kit for Shot Meters and Foot Valves	3.472 lb, 98.4 g	1

KDS301

VACUUM PICK-UP WAND

- Attaches to the air accessory port of the KDS824A (page 76) shot meters
- A finger control on the wand allows you to easily pick up small components
- Comes with three sizes of ESD safe suction cups



Catalog No.	UPC No.	Packed	Description	Pack Weight	Pack Quantity
KDS301	037103174260	Bagged	Vacuum Pick-up Wand	0.223 lb, 6.3 g	1

SYRINGES

3 VERSIONS FOR MULTIPLE APPLICATIONS

AIR-OPERATED SYRINGES

- Industrial syringes for micro-air dispensing
- Available in Luer Lok™ and tapered tip styles
- Unassembled and non-calibrated
- Available with rubber or plastic stoppers
- Includes barrel and stopper



Catalog No.	UPC No.	Packed	Size	Stopper	Tip	Pack Weight		Pack Quantity
						lb	g	
A3LL	037103176950	Bagged	3CC	Rubber	Luer Lok™	0.144	4.1	20
A3LLPS	037103176967	Bagged	3CC	Plastic	Luer Lok™	0.117	3.3	20
A5LL	037103176974	Bagged	5CC	Rubber	Luer Lok™	0.206	5.8	20
A5LLPS	037103178268	Bagged	5CC	Plastic	Luer Lok™	0.156	4.4	20
A6T	037103177537	Bagged	6CC	Rubber	Tapered	0.221	6.3	20
A10LL	037103178244	Bagged	10CC	Rubber	Luer Lok™	0.232	6.6	15
A10LLPS	037103176912	Bagged	10CC	Plastic	Luer Lok™	0.181	5.1	15
A30LL	037103176936	Bagged	30CC	Rubber	Luer Lok™	0.370	10.5	10
A30LLPS	037103176943	Bagged	30CC	Plastic	Luer Lok™	0.268	7.6	10
A30T	037103177490	Bagged	30CC	Rubber	Tapered	0.334	9.5	10

MANUAL UNASSEMBLED SYRINGES

- Includes barrel, rubber stopper, and plunger rod
- Available in Luer Lok™ and tapered tip styles
- Unassembled and non-calibrated



Catalog No.	UPC No.	Packed	Size	Stopper	Tip	Pack Weight		Pack Quantity
						lb	g	
M5LL	037103177223	Bagged	5CC	Rubber	Luer Lok™	0.280	7.9	20
M6T	037103177612	Bagged	6CC	Rubber	Tapered	0.307	8.7	20
M10LL	037103176981	Bagged	10CC	Rubber	Luer Lok™	0.317	9.0	15
M30T	037103177575	Bagged	30CC	Rubber	Tapered	0.547	15.5	10
M50LL	037103177179	Bagged	50CC	Rubber	Luer Lok™	0.459	13.0	5

MANUAL ASSEMBLED CALIBRATED SYRINGES

- Includes graduated barrel, rubber stopper, and plunger rod
- Available in Luer Slip™ and tapered tip styles (50cc only)



Catalog No.	UPC No.	Packed	Size	Stopper	Tip	Pack Weight		Pack Quantity
						lb	g	
M1LASSM	037103177049	Bagged	1CC	Rubber	Luer Slip™	0.152	4.3	20
M1BA	037103177056	Boxed	1CC	Rubber	Luer Slip™	16.000	453.3	3000
M3LLASSM	037103177131	Bagged	3CC	Rubber	Luer Lok™	0.179	5.1	20
M3LLASSM100	037103177148	Bagged	3CC	Rubber	Luer Lok™	0.759	21.5	100
M3LLBA	037103177155	Boxed	3CC	Rubber	Luer Lok™	13.700	388.1	1600
M5LLASSM	037103177230	Bagged	5CC	Rubber	Luer Lok™	0.261	7.4	20
M5LLBA	037103177254	Boxed	5CC	Rubber	Luer Lok™	18.360	520.1	1400
M10LLASSM	037103176998	Bagged	10CC	Rubber	Luer Lok™	0.294	8.3	15
M10LLBA	037103177025	Boxed	10CC	Rubber	Luer Lok™	16.650	471.7	850
M20LLBA	037103177070	Boxed	20CC	Rubber	Luer Lok™	11.890	336.8	325
M30LLASSM	037103177094	Bagged	30CC	Rubber	Luer Lok™	0.452	12.8	10
M30LLBA	037103177100	Boxed	30CC	Rubber	Luer Lok™	11.160	316.2	225
M50LLASSM	037103178251	Bagged	50CC	Rubber	Luer Lok™	0.412	11.7	5
M50TASSM	037103177209	Bagged	50CC	Rubber	Tapered	0.419	11.9	5
M50TBA	037103177216	Boxed	50CC	Rubber	Tapered	11.140	315.6	125



UNIVERSAL ADAPTERS

UNIQUE DESIGN WORKS WITH MOST MANUFACTURER'S SYRINGES

- Compatible with Luer Lok™, Luer Slip™, and tapered tip air operated syringes (see pages 79)
- 360° swivel on adapter head for ease of motion
- Use with single component, two part, self-leveling, and nonself-leveling materials
- Requires minimal clean-up
- Four sizes fit from 3cc to 30cc syringes
- Plastic adapters are lightweight and low cost
- Metal adapters fit many odd size syringes

METAL ADAPTERS ASSEMBLIES

- Metal syringe adapter with 6' air line and fitting
- Plugs directly into any Weller or Kahnetics shot meter



Catalog No.	UPC No.	Packed	Size	Airline Diameter		Pack Weight		Pack Quantity
						lb	g	
KDS803S6	037103173928	Bagged	3CC	3/32"	2.4 mm	0.112	3.2	1
KDS805S6	037103173966	Bagged	5CC	3/32"	2.4 mm	0.143	4.1	1
KDS810S6	037103174017	Bagged	10CC	3/32"	2.4 mm	0.152	4.3	1
KDS830S6	037103174048	Bagged	30CC	3/32"	2.4 mm	0.216	6.1	1

METAL ADAPTER HEADS

- Syringe adapter head only - no air line



Catalog No.	UPC No.	Packed	Size	Airline Diameter	Pack Weight		Pack Quantity
					lb	g	
KDS810S	037103174000	Bagged	10CC	Accommodates 3/32" Airline	0.112	3.2	1
KDS830S	037103174031	Bagged	30CC	Accommodates 3/32" Airline	0.165	4.7	1

PLASTIC ADAPTER ASSEMBLIES

- Plastic syringe adapter with 6' air line and fitting
- Plugs directly into any Weller or Kahnetics shot meter



Catalog No.	UPC No.	Packed	Size	Airline Diameter		Pack Weight		Pack Quantity
						lb	g	
KDS503S6	037103174093	Bagged	3CC	3/32"	2.4 mm	0.078	2.2	1
KDS505S6	037103174109	Bagged	5CC	3/32"	2.4 mm	0.094	2.7	1
KDS510S6	037103174130	Bagged	10CC	3/32"	2.4 mm	0.100	2.8	1
KDS530S6	037103174154	Bagged	30CC	3/32"	2.4 mm	0.113	3.2	1

PLASTIC ADAPTER HEADS

- Syringe adapter head only - no air line



Catalog No.	UPC No.	Packed	Size	Airline Diameter	Pack Weight		Pack Quantity
					lb	g	
KDS503S	037103178947	Bagged	3CC	Accommodates 3/32" Airline	0.034	1.0	1
KDS510S	037103174123	Bagged	10CC	Accommodates 3/32" Airline	0.049	1.4	1
KDS530S	037103174147	Bagged	30CC	Accommodates 3/32" Airline	0.073	2.1	1

SYRINGE COMPONENTS

DISPENSING

SUPPLIED IN BULK QUANTITIES

- Disposable un-assembled non-calibrated components
- Plastic or lubricated rubber stoppers
- Luer Slip™ (1cc), Luer Lok™, and tapered tip styles



Catalog No.	UPC No.	Packed	Size	Component Type	Tip Type	Pack Weight lb	Pack Weight g	Pack Quantity
1L1	037103176691	Bagged	1CC	Barrel	Luer Slip™	3.300	93.5	1000
1L2	037103176707	Bagged	1CC	Rubber Stopper	Luer Slip™	0.662	18.8	1000
1L4	037103176714	Bagged	1CC	Plunger Rod	Luer Slip™	1.271	36.0	1000
3LL1	037103176790	Bagged	3CC	Barrel	Luer Lok™	4.563	129.3	1000
3LL1B	037103183286	Bagged	3CC	Barrel	Luer Lok™	12.900	365.5	2500
3LL2	037103178213	Bagged	3CC	Rubber Stopper	Luer Lok™	1.120	31.7	1000
3LL2M	037103184542	Bagged	3CC	Manual Stopper	Luer Lok™	0.422	12.0	1000
3LL4B	037103183262	Bagged	3CC	Plunger Rod	Luer Lok™	9.650	273.4	4000
5LL1	037103176868	Bagged	5CC	Barrel	Luer Lok™	6.220	176.2	1000
5LL1B	037103183255	Bagged	5CC	Barrel	Luer Lok™	11.750	332.9	1600
5LL2	037103176875	Bagged	5CC	Rubber Stopper	Luer Lok™	2.570	72.8	1000
5LL2B	037103183248	Bagged	5CC	Rubber Stopper	Luer Lok™	40.000	1133.2	15,000
5LL2M	037103176882	Bagged	5CC	Manual Stopper	Luer Lok™	1.021	28.9	1000
5LL2PS	037103177445	Bagged	5CC	Plastic Stopper	Luer Lok™	0.490	13.9	1000
5LL4	037103176899	Bagged	5CC	Plunger Rod	Luer Lok™	5.050	143.1	1000
6T1	037103177452	Bagged	6CC	Barrel	Tapered	5.178	146.7	500
6T2	037103177469	Bagged	6CC	Manual Stopper	Tapered	0.695	19.7	500
6T4	037103177483	Bagged	6CC	Plunger Rod	Tapered	2.045	57.9	500
10LL1	037103176646	Bagged	10CC	Barrel	Luer Lok™	10.350	293.2	1000
10T1	037103177308	Bagged	10CC	Barrel	Tapered	5.307	150.3	500
10LL2	037103176653	Bagged	10CC	Rubber Stopper	Luer Lok™	3.995	113.2	1000
10LL2M	037103176660	Bagged	10CC	Manual Stopper	Luer Lok™	4.300	121.8	1000
10LL2PS	037103177285	Bagged	10CC	Plastic Stopper	Luer Lok™	0.997	28.2	1000
10LL4	037103176684	Bagged	10CC	Plunger Rod	Luer Lok™	10.300	291.8	1000
30LL1PS	037103176745	Bagged	30CC	Barrel for Plastic Stopper	Luer Lok™	12.645	358.2	600
30T1	037103177353	Bagged	30CC	Barrel	Tapered	14.983	424.5	500
30LL2PS	037103177346	Bagged	30CC	Plastic Stopper	Luer Lok™	1.651	46.8	1000
30T2A	037103177360	Bagged	30CC	Dry Air-operated Stopper	Tapered	2.263	64.1	500
30T4	037103177384	Bagged	30CC	Plunger Rod	Tapered	12.555	355.7	500
30T3	037103177377	Bagged	30CC	Tip Cap/30CC Tapered Barrel	Tapered	0.194	5.5	100
50LL1	037103176820	Bagged	50CC	Barrel	Luer Lok™	16.820	476.5	375
50LL1GRAD	037103178220	Bagged	50CC	Barrel with Graduations	Luer Lok™	17.310	490.4	375
50LL2	037103176844	Bagged	50CC	Rubber Stopper	Luer Lok™	17.550	497.2	1000
50LL4	037103178237	Bagged	50CC	Plunger Rod	Luer Lok™	19.890	563.5	600

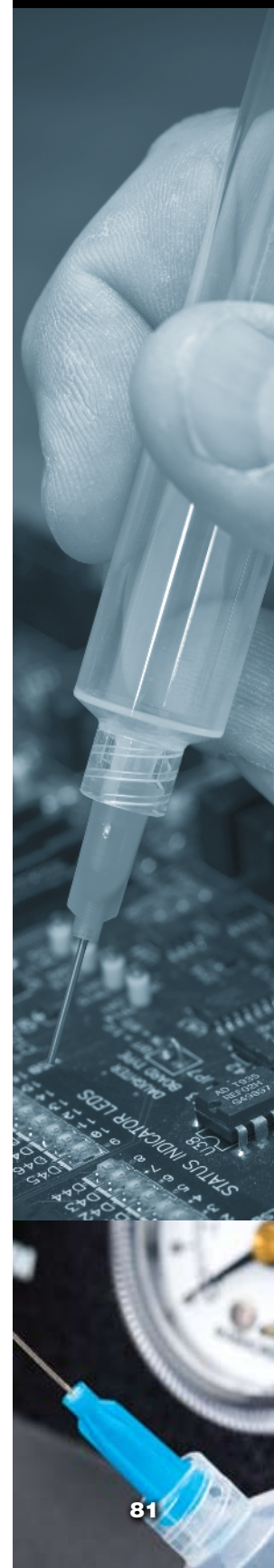

NEEDLES

LARGE SELECTION OF SIZES, GAUGES, AND PACKAGING OPTIONS

- Selection includes non-sterile blunt stainless steel needles with plastic hubs, and one-piece plastic tapered tip needles
- All needles lock on to Luer Lok™ style syringes
- Needle covers, and scabbards are also available



STAINLESS STEEL PLASTIC HUB DISPENSING NEEDLES

- Sizes range from 14 through 30 gauge
- Lengths range from 1/2" (12.7mm) to 1 1/2" (38.1mm)

Catalog No.	UPC No.	Packed	Gauge	ID		OD		Length		Pack Quantity	Hub Color	Pack Weight	
				Inch	mm	Inch	mm	Inch	mm			lb	g
KDS141BT	037103174758	Bagged	14	0.067	1.70	0.083	2.11	1	25.40	1000	Dark Green	1.111	31.5
KDS141P	037103174765	Bagged	14	0.067	1.70	0.083	2.11	1	25.40	50	Dark Green	0.076	2.2
KDS1412BT	037103174727	Bagged	14	0.067	1.70	0.083	2.11	1/2	12.70	1000	Dark Green	0.746	21.1
KDS1412P	037103174734	Bagged	14	0.067	1.70	0.083	2.11	1/2	12.70	50	Dark Green	0.076	2.2
KDS1512BT	037103174833	Bagged	15	0.060	1.52	0.072	1.83	1/2	12.70	1000	Orange	0.781	22.1
KDS1512P	037103174840	Bagged	15	0.060	1.52	0.072	1.83	1/2	12.70	50	Orange	0.049	1.4
KDS151P	037103174871	Bagged	15	0.060	1.52	0.072	1.83	1	25.40	50	Orange	0.065	1.8
KDS161BT	037103174987	Bagged	16	0.053	1.35	0.064	1.63	1	25.40	1000	Purple	0.892	25.3
KDS161P	037103174994	Bagged	16	0.053	1.35	0.064	1.63	1	25.40	50	Purple	0.056	1.6
KDS1612BT	037103174956	Bagged	16	0.053	1.35	0.064	1.63	1/2	12.70	1000	Purple	0.679	19.2
KDS1612P	037103174963	Bagged	16	0.053	1.35	0.064	1.63	1/2	12.70	50	Purple	0.048	1.4
KDS16112BT	037103174925	Bagged	16	0.053	1.35	0.064	1.63	1 1/2	38.10	1000	Purple	1.050	29.7
KDS16112P	037103174932	Bagged	16	0.053	1.35	0.064	1.63	1 1/2	38.10	50	Purple	0.064	1.8
KDS1712BT	037103181183	Bagged	17	0.045	1.14	0.060	1.52	1/2	12.70	1000	White	0.659	18.7
KDS1712P	037103175021	Bagged	17	0.045	1.14	0.060	1.52	1/2	12.70	50	White	0.045	1.3
KDS1812BT	037103175113	Bagged	18	0.038	0.97	0.050	1.27	1/2	12.70	1000	Pink	0.620	17.6
KDS1812P	037103175120	Bagged	18	0.038	0.97	0.050	1.27	1/2	12.70	50	Pink	0.048	1.4
KDS181BT	037103178176	Bagged	18	0.038	0.97	0.050	1.27	1	25.40	1000	Pink	0.725	20.5
KDS181P	037103175168	Bagged	18	0.038	0.97	0.050	1.27	1	25.40	50	Pink	0.048	1.4
KDS1912P	037103185877	Bagged	19	0.032	0.81	0.042	1.07	1/2	12.70	50	Brown	0.048	1.4
KDS191BT	037103175274	Bagged	19	0.032	0.81	0.042	1.07	1	25.40	1000	Brown	0.678	19.2
KDS191P	037103175281	Bagged	19	0.032	0.81	0.042	1.07	1	25.40	50	Brown	0.048	1.4
KDS2012BT	037103175342	Bagged	20	0.026	0.66	0.035	0.89	1/2	12.70	1000	Yellow	0.586	16.6
KDS2012P	037103175359	Bagged	20	0.026	0.66	0.035	0.89	1/2	12.70	50	Yellow	0.040	1.1
KDS201BT	037103175373	Bagged	20	0.026	0.66	0.035	0.89	1	25.40	1000	Yellow	0.637	18.0
KDS201P	037103175380	Bagged	20	0.026	0.66	0.035	0.89	1	25.40	50	Yellow	0.045	1.3
KDS20112BT	037103175304	Bagged	20	0.026	0.66	0.035	0.89	1 1/2	38.10	1000	Yellow	0.768	21.8
KDS2112BT	037103175441	Bagged	21	0.023	0.58	0.032	0.89	1/2	12.70	1000	Green	0.554	15.7
KDS2112P	037103175458	Bagged	21	0.023	0.58	0.032	0.89	1/2	12.70	50	Green	0.041	1.2
KDS211P	037103175489	Bagged	21	0.023	0.58	0.032	0.89	1	25.40	50	Green	0.043	1.2
KDS2212BT	037103175526	Bagged	22	0.019	0.48	0.028	0.71	1/2	12.70	1000	Black	0.558	15.8
KDS2212P	037103175533	Bagged	22	0.019	0.48	0.028	0.71	1/2	12.70	50	Black	0.043	1.2
KDS221BT	037103175564	Bagged	22	0.019	0.48	0.028	0.71	1	25.40	1000	Black	0.650	18.4
KDS221P	037103175571	Bagged	22	0.019	0.48	0.028	0.71	1	25.40	50	Black	0.045	1.3
KDS2312BT	037103175625	Bagged	23	0.017	0.43	0.025	0.64	1/2	12.70	1000	Light Blue	0.565	16.0
KDS2312P	037103175632	Bagged	23	0.017	0.43	0.025	0.64	1/2	12.70	50	Light Blue	0.042	1.2
KDS2512BT	037103175762	Bagged	25	0.012	0.30	0.020	0.51	1/2	12.70	1000	Blue	0.519	14.7
KDS2512P	037103175779	Bagged	25	0.012	0.30	0.020	0.51	1/2	12.70	50	Blue	0.040	1.1
KDS2612BT	037103175830	Bagged	26	0.010	0.25	0.018	0.46	1/2	12.70	1000	Tan	0.520	14.7
KDS27516BT	037103181336	Bagged	27	0.008	0.20	0.015	0.38	5/16	7.94	1000	Grey	0.496	14.4
KDS2712BT	037103181312	Bagged	27	0.008	0.20	0.015	0.38	1/2	12.70	1000	Grey	0.536	15.2
KDS3012BT	037103175953	Bagged	30	0.006	0.15	0.012	0.30	1/2	12.70	1000	Lavender	0.483	13.7
KDS3012P	037103175960	Bagged	30	0.006	0.15	0.012	0.30	1/2	12.70	50	Lavender	0.039	1.1
KDS660	037103176004	Bagged	1								Assorted	1.779	50.4
KDSSAMPLEPAC	037103176011	Bagged	1								Assorted	0.012	0.03

TAPERED TIP NEEDLES

- Sizes range from 14 through 24 gauge
- Length is 1 1/2" (38.1mm)
- Taper reduces dripping from needle
- Plastic material won't scratch delicate surfaces



Catalog No.	UPC No.	Packed	Gauge	ID		Pack Quantity	Hub Color	Pack Weight	
				Inch	mm			lb	g
KDS14TN25	037103176356	Bagged	14	0.063	1.60	25	Salmon	0.015	0.4
KDS14TNP	037103176363	Bagged	14	0.063	1.60	50	Salmon	0.050	1.4
KDS14TN	037103176349	Bagged	14	0.063	1.60	100	Salmon	0.062	1.8
KDS16TN25	037103176387	Bagged	16	0.048	1.22	25	Grey	0.015	0.4
KDS16TNP	037103176400	Bagged	16	0.048	1.22	50	Grey	0.050	1.4
KDS16TNB	037103179012	Bagged	16	0.048	1.22	1000	Grey	0.490	13.9
KDS18TN25	037103176424	Bagged	18	0.034	0.86	25	Green	0.015	0.4
KDS18TNP	037103176431	Bagged	18	0.034	0.86	50	Green	0.045	1.3
KDS18TN	037103176417	Bagged	18	0.034	0.86	100	Green	0.058	1.6
KDS18TNB	037103179029	Bagged	18	0.034	0.86	1000	Green	0.475	13.5
KDS20TN25	037103176455	Bagged	20	0.024	0.61	25	Pink	0.015	0.4
KDS20TNP	037103176479	Bagged	20	0.024	0.61	50	Pink	0.041	1.2
KDS20TN	037103176448	Bagged	20	0.024	0.61	100	Pink	0.058	1.6
KDS20TNB	037103179043	Bagged	20	0.024	0.61	1000	Pink	0.460	13.0
KDS22TN25	037103176493	Bagged	22	0.017	0.43	25	Blue	0.015	0.4
KDS22TNP	037103176509	Bagged	22	0.017	0.43	50	Blue	0.043	1.2
KDS22TN	037103176486	Bagged	22	0.017	0.43	100	Blue	0.058	1.6
KDS22TNB	037103179050	Bagged	22	0.017	0.43	1000	Blue	0.450	12.7

TIP CAPS AND NEEDLE SCABBARDS

- Used to seal needles and syringes when not in use
- Luer Lok™ and press fit styles available for all styles of syringes



Catalog No.	UPC No.	Packed	Description	Pack Weight		
				lb	g	Quantity
5227K	037103176639	Bagged	Plastic Tip Cap	0.053	1.5	100
KDS20SC	037103176592	Bagged	Needle Scabbard, 20 Gauge	0.039	1.1	100
982	037103176615	Bagged	Rubber Stopper	0.095	2.7	100
SKDS1TCCH	-	Bagged	Clear Plastic Cap	0.053	1.5	100
SKDS125TCCH	-	Bagged	Soft Black Plastic Tip Cap	0.053	1.5	100

MISCELLANEOUS ACCESSORIES

KDS805FS Finger Switch for Shot Meters

- Plugs in to KDS808, KDS834, and KDS824 series Shot Meters
- Replaces the foot pedal as method of actuation

KDS816 Syringe Holder Stand

- Compatible with all sizes of syringes and adapters
- Keeps syringe upright - preventing accidental flow of material back up the air line
- Keeps work bench neat and clean



Catalog No.	UPC No.	Descriptionr	Pack Weight lb	Pack Weight g	Pack Quantity
KDS805FS	037103178077	Finger Switch for Shot Meters	0.147	4.2	1
KDS816	037103178091	Syringe Holder Stand	0.620	17.2	1



Cat. No.	Page No.	Cat. No.	Page No.	Cat. No.	Page No.	Cat. No.	Page No.
33	64	0053657399	51	0058736837	41	DX113	32
37UG	63, 64	0053657499	52	0058736838	41	DX113HM	32
100UG	65	0053657599	52	0058736839	41	DX114	32
333	65	0053657699	50	0058736840	41	DX115	32
360	64	0053657799	51	0058736841	41	DX116	32
362	64	0053657899	51	0058736842	41	DX117	32
363	64	0053658099	51	0058736843	41	DX118	32
533S	64	0053659099	53	0058736857	41	DX119	32
535S	64	0053659199	52	0058736858	41	DX120	32
537S	63, 64	0053659299	52	0058736867	41	DXV80	26, 27
1080	69	0053659399	53	0058736870	41	EC234	75
1082	69	0053659499	53	0058736873	41	ESF120ESD	73
1085	69	0053659599	53	0058736876	41	ETA	23
1095	69	0053659799	57	0058736877	41	ETAA	23
1233S	64	0053659899	51	0058736880	41	ETB	23
1235S	64	0054450199	5	0058736881	41	ETBB	23
1237S	63, 64	0054450299	5	0058736882	41	ETC	23
4033S	64	0054450399	5	0058736883	41	ETCC	23
4035S	64	0058727772	33	0058736890	41	ETD	23
4037S	63, 64	0058727773	33	0058736891	41	ETDD	23
4039S	64	0058727774	33	0058736892	41	ETH	23
6956	69	0058727777	33	0058736998	41	ETJ	23
6957	69	0058727778	33	0058736999	41	ETK	23
6958	69	0058727779	33	0058741815	26	ETKN	23
6959	69	0058727780	33	0058744710	5	ETL	23
6964	69	0058727781	33	0058744845	5, 9	ETM	23
6965A	69	0058727782	33	0058744846	5, 9	ETO	23
6966C	69	0058727783	33	0058744875	56	ETP	23
7155	65	0058727784	33	0058744876	56	ETR	23
7400	63, 64	0058727785	33	0058750709	41	ETS	23
7500	63, 64	0058727786	33	0058750714	41	ETT	23
7760	63, 64	0058727787	33	0058750721	41	ETU	23
7770	63, 64	0058727821	33	0058751710	7	ETV	23
7805	71	0058727822	33	0058754873	36	FD2	71
7874B	73	0058727823	33	0058754924	36	FD2D	71
7875B	73	0058735313	50	0058755741	36	FD3	71
7880	73	0058735427	50	0058755745	36	FD21D	71
7881	73	0058735831	50	0058755782	37	FE75	17, 19, 56
7882BK	73	0058735832	50	0058762701	53	G7A	70
7883	73	0058735833	50	0058762750	52	HAP1	39, 40
0051303199	74	0058735835	53	0058762753	52	Hot Air Nozzles	33
0051382499	74	0058735836	53, 57	AK20	56	K111	72
0051502699	73	0058735837	53, 57	AK51	18	K181	72
0051503099	56	0058735838	53, 57	AKFE11	56	K191	72
0051504899	37	0058735840	53	CP01	72	K1101	72
0051504999	37	0058735845	51	CT5A7	62	K1111	72
0051506599	56	0058735847	50	CT5A8	62	K1121	72
0051506699	56	0058735848	50	CT5B8	62	KDS301	78
0051512499	74	0058735855	59	CT5C7	62	KDS503S	80
0051515699	56	0058735856	59	CT5C8	62	KDS503S6	80
0052512599	56	0058735860	53	CT5D7	62	KDS505S6	80
0052541000	56	0058735863	59	CT5D8	62	KDS510S	80
0052916699	56	0058735864	59	CT5E7	62	KDS510S6	80
0052918599	56	0058735865	57	CT5E8	62	KDS530S	80
0052918699	56	0058735866	57	CT6C6	62	KDS530S6	80
0053119099	37	0058735869	59	CT6C7	62	KDS803S6	80
0053119199	53	0058735870	59	CT6C8	62	KDS805S6	80
0053631699	57	0058735871	59	CT6D6	62	KDS806(V)	77
0053631999	59	0058735879	50	CT6D7	62	KDS808	77
0053632199	59	0058735883	53	CT6D8	62	KDS810S	80
0053632299	59	0058735884	53	CT6E6	62	KDS810S6	80
0053632399	59	0058735885	53	CT6E7	62	KDS824A	76
0053632499	59	0058735895	53	CT6E8	62	KDS830S	80
0053632699	57	0058735909	53	CT6F6	62	KDS830S6	80
0053632999	59	0058735915	53	CT6F7	62	KDS834A	76
0053633899	57	0058735920	53	CT6F8	62	KDSDELUXEKIT	78
0053634399	57	0058735924	53	CT6F9	62	LHTD	18
0053634499	59	0058736804	41	CT6G7	62	LHTD45	18
0053638099	51	0058736807	41	D550	70	LHTDX	18
0053640799	57	0058736814	41	D650	70	LHTE	18
0053641099	57	0058736818	41	Desoldering Triplets	32	LHTEX	18
0053641400	57	0058736819	41	DX110	32	LHTF	18
0053641599	57	0058736833	41	DX111	32	LHTFX	18
0053642199	57	0058736836	41	DX112	32	LT1	5



Cat. No.	Page No.	Cat. No.	Page No.	Cat. No.	Page No.	Cat. No.	Page No.
LT1L	5	PSI100K	66	RTW4MS	15	WHC54	68
LT1LX	5	PTA6	25	SD74	71	WHP80	17, 18
LT1S	5	PTA7	24, 25, 61	SD74H	71	WHP200	42
LT1SLX	5	PTA8	25	SL325	63, 64	WHP1000	43
LT1X	5	PTAA7	25	SL335	63, 64	WHP3000	34, 35, 36
LT4X	5	PTAA8	25	SL345	63, 64	WLSK200	74
LTA	5	PTB7	25	SL500	63, 64	WM120	63
LTAS	5	PTB8	25	SM1	74	WMP	8, 17, 20
LTAX	5	PTBB7	25	ST1	62	WMRP	12, 14, 16, 17, 20
LTB	5	PTBB8	25	ST2	62	WMRPMS	15, 17
LTC	5	PTC7	25	ST3	62	WMRT	12, 14, 16, 17, 18
LTC8	5	PTC8	25	ST4	62	WMRTH	12, 16, 18
LTD	5	PTCC7	25	ST5	62	WMRTMS	15, 17
LTF	5	PTCC8	25	ST6	62	WP25	61, 62
LTH	5	PTD7	25	ST7	62	WP30	56, 61, 62
LTHX	5	PTD8	25	ST8	62	WP35	56, 61, 62
LTK	5	PTDD7	25	SW60	75	WP80	4, 9, 17, 20
LTKN	5	PTDD8	25	Syringe Components	81	WP120	9, 10, 17, 19
LTL	5	PTE8	25	Syringes	79	WPA2	68
LTM	5	PTF7	25	TC201T	24, 56, 75	WPB1	74
LTS	5	PTF8	25	TC217	75	WPT1	68
MP131	63	PTH6	25	TCP12P	61	WPT2	68
MP133	63	PTH7	25	Thermal Tweezer Tips	32	WPT5	68
MPR80	17, 19	PTH8	25	Universal Adapters	80	WPT8	68
Needles	82	PTJ7	25	W60P	56, 61, 62	WPT11	68
NT1	7, 20	PTJ8	25	W60P3	61	WPT13	68
NT1S	7	PTK7	25	W100P	62	WPT15	68
NT1X	7	PTK8	25	W100P3	61	WR2	27
NT4	7	PTL7	25	W100PG	56, 61	WR2000	39
NT6	7	PTL8	25	W58713798	41	WR2000VX	28
NTA	7	PTM7	25	W58713799	41	WR2000X	27
NTAX	7	PTM8	25	WA2000	72	WR3000M	29
NTB	7	PTO6	25	WAD101	40	WSA350	60
NTC	7	PTO7	25	WB1	67	WSA350F	60
NTD	7	PTO8	25	WB2	67	WSB80	17, 19
NTGW	7	PTP6	25	WBH2	73	WSB150	17, 19
NTH	7	PTP7	25	WBHS	34, 36	WSM1	13
NTK	7	PTP8	25	WCB1	26	WSM1C	13
P2C	67	PTR6	25	WD1	4, 6, 8, 9	WSP80	17, 20
P2KC	67	PTR7	25	WD1M	11, 16	WSP150	17, 18
PES51	21, 22	PTR8	25	WD2	8	WST2	68
PH50	21, 22	PTS7	25	WD2M	16, 18	WST3	68
PH60	61	PTS8	25	WD1000HPT	6, 9	WSTA3	68
PH100	61	PU120T	24	WD1000M	11, 16	WSTA6	68
PH1201ESD	24	RT1	14	WD1001	6, 8	WTA1	18, 32
Pipe Systems	59	RT1MS	15	WD1002	4, 9	WTA2	32
PL100	65	RT1SC	14	WD1002T	4, 9	WTA3	32
PL111	63, 65	RT1SCMS	15	WD2000M	12, 16	WTA4	32
PL113	63, 65	RT2	14	WD2M	18	WTA5	32
PL114	65	RT2MS	15	WDC	74	WTA50	17, 18
PL133	63, 65	RT3	14, 20	WDC2	74	WTCPT	24
PL138	65	RT3MS	15	WDD81X	26	XTA	10
PL151	65	RT4	14	WDH10	9, 20	XTAA	10
PL153	65	RT4MS	15	WDH10T	4, 9	XTAL	10
PL155	65	RT5	14	WDH20	8, 20	XTB	10
PL331	65	RT5MS	15	WDH40	26, 27, 28	XTBB	10
PL333	65	RT6	14	WDH50	12, 16, 20	XTBS	10
PL338	65	RT6MS	15	WES51	21	XTC	10
PL350	65	RT7	14	WES51PU	21	XTCC	10
PPT1	67	RT7MS	15	WESD51	22	XTCS	10
PPT2	67	RT8	14	WESD51PU	22	XTD	10
PPT5	67	RT8MS	15	WFE2ES	48	XTDS	10
PPT6	67	RT9	14	WFE2P	19, 54, 58	XTE	10
PSI1	66	RT9MS	15	WFE2S	47, 49	XTF	10
PSI2	66	RT10	14	WFE2X	46	XTGW	10
PSI3	66	RT10MS	15	WFE4S	45, 49	XTH	10
PSI4	66	RT11MS	15	WFE8S	44	XTKN	10
PSI5	66	RTW1	14	WFE20D	55, 58	XTM	10
PSI6	66	RTW1MS	15	WHA900	38	XTO	10
PSI7	66	RTW2	14	WHA3000P	34, 35, 37		
PSI8	66	RTW2MS	15	WHA3000PS	34, 36		
PSI9	66	RTW3	14	WHA3000V	35, 37		
PSI10	66	RTW3MS	15	WHC51	68		
PSI100C	66	RTW4	14	WHC52	68		





Weller®



*Acuna Tools Corp
3100 NW 72 Ave
Suite 103
Miami, FL 33122*

*Tel: (305) 592-4438
Judy@acunatools.com*



14600 York Road, Suite A
Sparks, MD 21152
www.apextoolgroup.com