



ProPort™ products provide access to AC power and data signals from the outside of a control cabinet. Computers and programming devices can access a PLC within the cabinet without opening the cabinet door.

Products are available with D-sub, RJ or mini-DIN connectors. A single AC outlet is available with most connector types and a 5A circuit breaker is optional.

Most ProPort™ products are available with 2 or 3 variations for the connections on the inside of the cabinet - screw terminals, bulkhead connectors, or cables.

AC outlets and circuit breakers are connected via quick tab terminals.



Two unique additions to the ProPort™ offering allow access to 4-20mA loops through make-before-break connections. A meter can be inserted and removed from a loop without a momentary interruption.

The housings are from Weidmuller's standard HDC family. Features include hinged, gasketed covers with secure latching levers. Housings are made from die-cast zinc and are rated NEMA 4 (IP65).

ProPort™ products are CSA approved and UL recognized.



ProPort™ Selection Matrix

Field Side				Reverse Side			Housing Size	Cat.#	Pg.
Conn. 1	Conn. 2	AC	C/B	Terminals	Bulk-head	Cable			
		•					3	7940000232	9
		•	•				6	7940000233	9
DB9-F				LM5.08			3	7940000256	3
DB9-F					DB9-M		3	7940000255	3
DB9-F						DB9-M	3	7940000254	3
DB9-F	DB9-F			LM5.08			6	7940000228	4
DB9-F	DB9-F				2xDB9-M		6	7940000227	4
DB9-F	DB9-F					2xDB9-M	6	7940000226	4
DB9-F		•		LM5.08			6	7940000219	3
DB9-F		•			DB9-M		6	7940000218	3
DB9-F		•				DB9-M	6	7940000217	3
DB9-F	DB9-F	•			2xDB9-M		6	7940000230	5
DB9-F	DB9-F	•				2xDB9-M	6	7940000229	5
DB9-M		•		LM5.08			6	7940000252	5
DB9-M		•			DB9-F		6	7940000251	5
DB9-M		•				DB9-F	6	7940000250	5
DB15-F		•			DB15-M		6	7940000221	6
DB15-F		•				DB15-M	6	7940000220	6
DB25-F		•			DB25-M		8	7940000224	6
DB25-F		•				DB25-M	8	7940000223	6
RJ12					RJ12		3	7940000243	8
RJ12	RJ12				2xRJ12		3	7940000240	8
RJ12		•			RJ12		6	7940000236	8
RJ45					RJ45		3	7940000241	8
RJ45					RJ45		3	7940000242	8
CAT5					CAT5				
RJ45		•			RJ45		6	7940000234	8
RJ45		•			RJ45		6	7940000235	8
CAT5					CAT5				
RJ45	RJ45				2xRJ45		3	7940000238	8
RJ45	RJ45				2xRJ45		3	7940000239	8
CAT5	CAT5				CAT5				
PS2	PS2					2xMini-DIN	3	7940000253	9
AB DH+						DB9-M	3	7940000244	7
AB DH+						Mini-DIN	3	7940000245	7
AB DH+				LM5.08			3	7940000246	7
AB DH+		•	•	LM5.08			8	7940000247	7
AB DH+		•	•			DB9-M	8	7940000248	7
AB DH+		•	•			Mini-DIN	8	7940000249	7
1/8" phono x 4 make-before-break				TOP 1.5			6	7926620004	10
1/8" phono x 8 make-before-break				TOP 1.5			10	7926620008	10

Housing dimensions located on page 11

**DB9-F Interface
Housing Size: 3**

FIELD VIEW

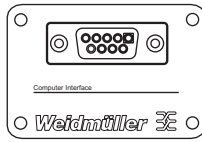

REVERSE VIEW

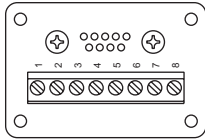

ELECTRICAL

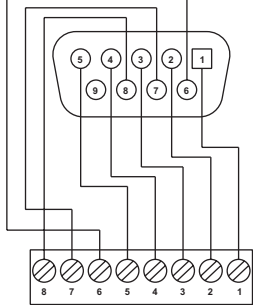

**Insert + Housing:
Catalog # 7940000256**

REVERSE VIEW

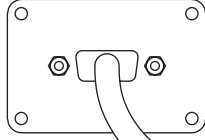

10 foot cable assembly

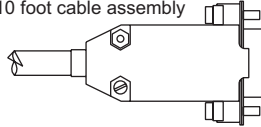

DB9 MALE

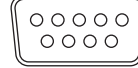

**Insert + Housing:
Catalog # 7940000254**

REVERSE VIEW

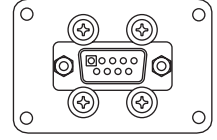

**Insert + Housing:
Catalog # 7940000255**

**DB9-F + AC Interface
Housing Size: 6**

FIELD VIEW

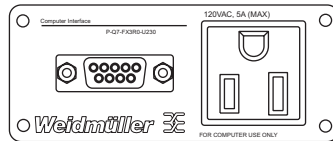

REVERSE VIEW

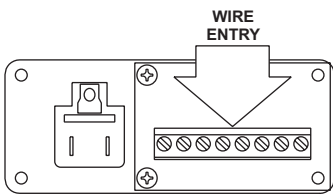

ELECTRICAL

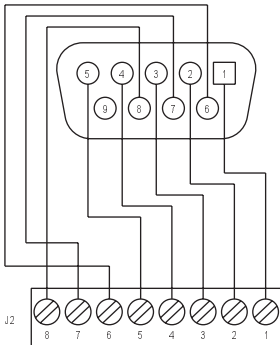

**Insert + Housing:
Catalog # 7940000219**

REVERSE VIEW

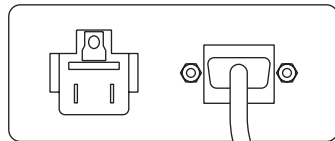

10 foot cable assembly

**Insert + Housing:
Catalog #: 7940000217**

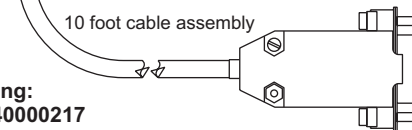

DB9M



REVERSE VIEW

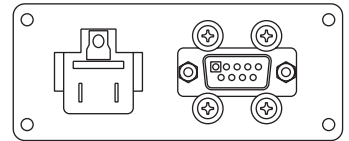

**Insert + Housing:
Catalog # 7940000218**

DB9-F x 2
Housing Size: 6

FIELD VIEW

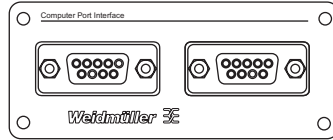

REVERSE VIEW

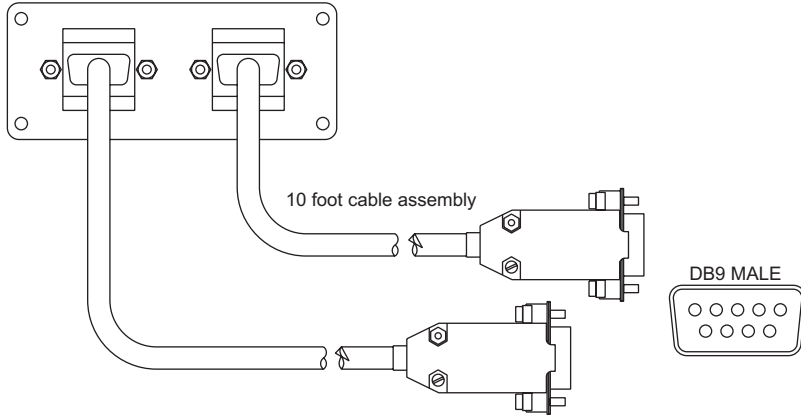

Insert + Housing:
Catalog # 7940000226

REVERSE VIEW

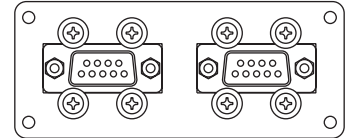

Insert + Housing:
Catalog # 7940000227

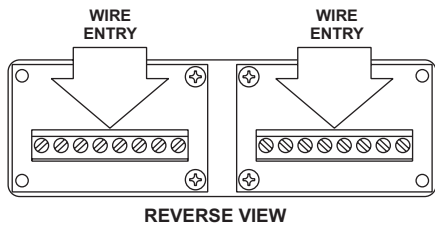

REVERSE VIEW

ELECTRICAL

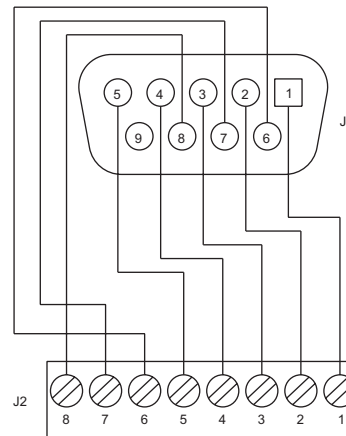

Insert + Housing:
Catalog # 7940000228

**DB9-F x 2 + AC Interface
Housing Size: 6**

FIELD VIEW

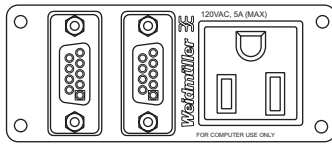

REVERSE VIEW

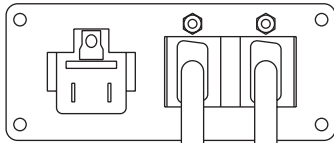

REVERSE VIEW

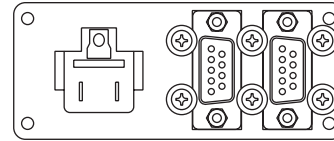

10 foot cable assemblies

**Insert + Housing:
Catalog # 7940000229**

Catalog #: 7940000230

DB9-M

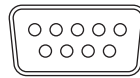

**DB9-M + AC Interface
Housing Size: 6**

FIELD VIEW

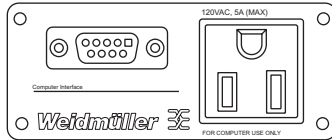

REVERSE VIEW

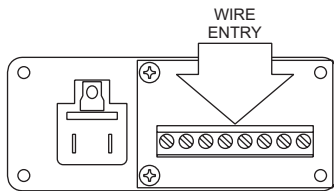

REVERSE VIEW

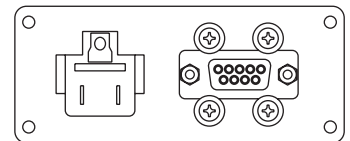

**Insert + Housing:
Catalog # 7940000251**

ELECTRICAL

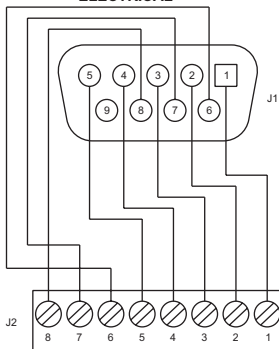

REVERSE VIEW

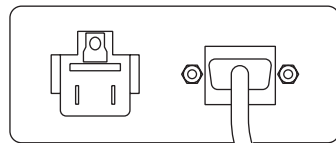

10 foot cable assembly

**Insert + Housing:
Catalog # 7940000250**

DB9F

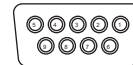

**Insert + Housing:
Catalog # 7940000252**

**DB15-F + AC Interface
Housing Size: 6**

FIELD VIEW

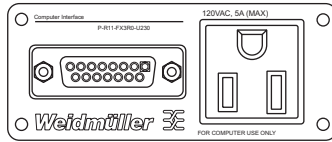

REVERSE VIEW

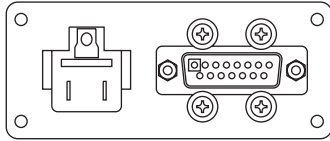

**Insert + Housing:
Catalog # 7940000221**

REVERSE VIEW

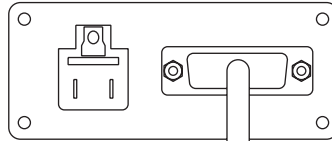

**Insert + Housing:
Catalog # 7940000220**

10 foot cable assembly

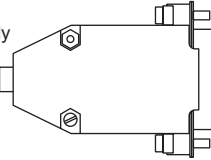

DB15 MALE

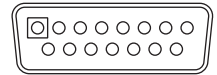

**DB25-F + AC Interface
Housing Size: 8**

FIELD VIEW

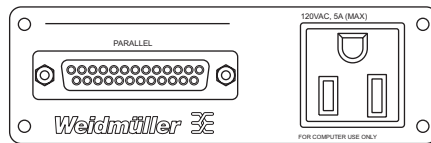

REVERSE VIEW

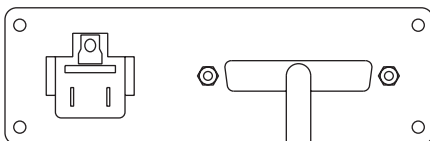

**Insert + Housing:
Catalog # 7940000223**

10 foot cable assembly

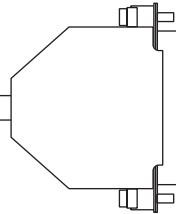

REVERSE VIEW

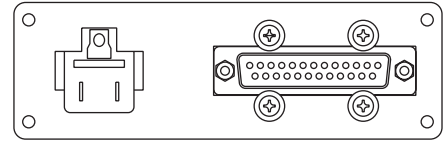

**Insert + Housing:
Catalog # 7940000224**

DB25 MALE

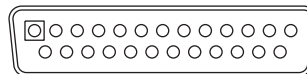

**AB DH+ Interface
Housing Size: 3**

FIELD VIEW

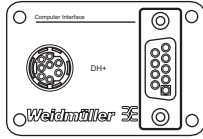

REVERSE VIEW

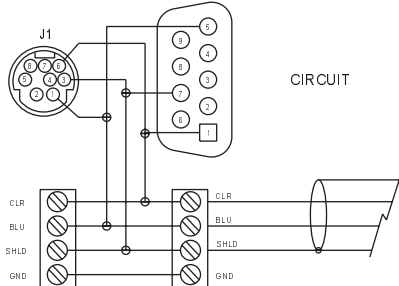
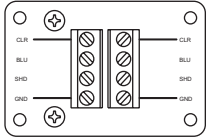

**Insert + Housing:
Catalog # 7940000246**

20 foot cable assembly

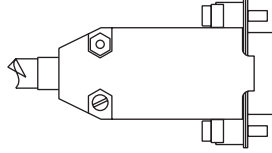

CABLE OPTIONS

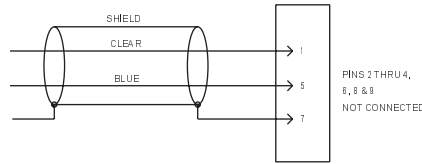
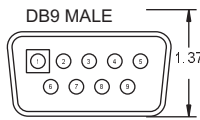

**Insert + housing:
Catalog # 7940000244**

20 foot cable assembly

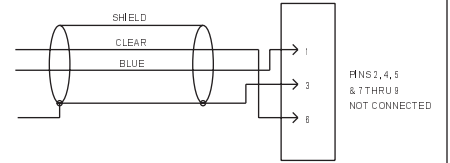
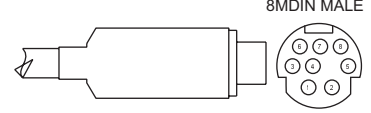

**Insert + housing:
Catalog # 7940000245**

**AB DH+ Interface
with AC Power + 5A Circuit Breaker
Housing Size: 8**

FIELD VIEW

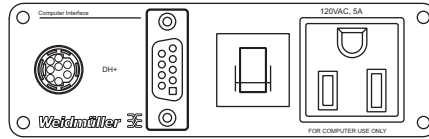

REAR VIEW

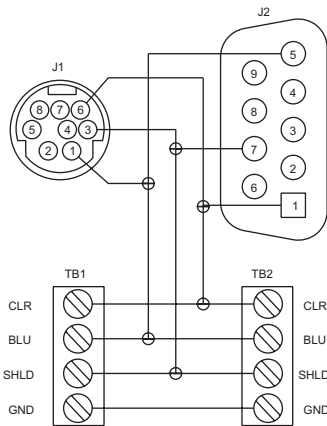
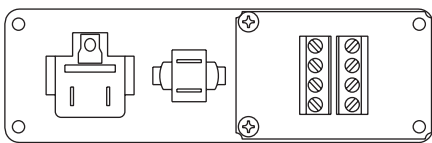

**Insert + Housing:
Catalog # 7940000247**

20 foot cable assembly

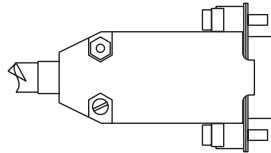

Cable Options

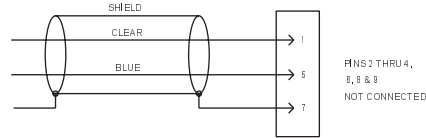
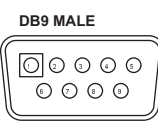

**Insert + Housing:
Catalog # 7940000248**

20 foot cable assembly

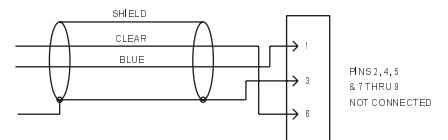
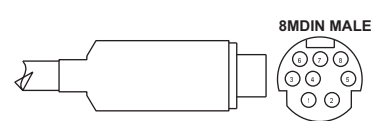

**Insert + Housing:
Catalog # 7940000249**

RJ-45 x 2 Interface
Housing Size: 3

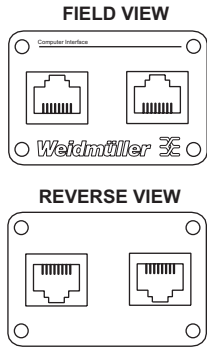

Insert + Housing:
Catalog # 7940000238

RJ45 - CAT5 Interface
Ethernet
Housing Size: 3

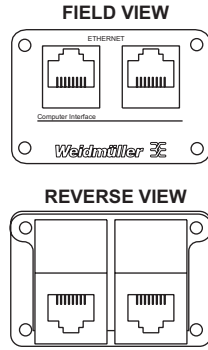

Insert + Housing:
Catalog # 7940000239

RJ 12 6 pole x 2 Interface
Housing Size: 3

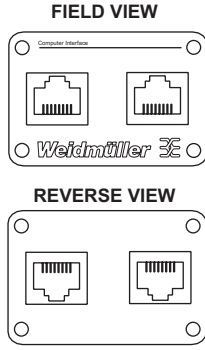

Insert + Housing:
Catalog # 79240000240

RJ-45 Interface
Housing Size: 3

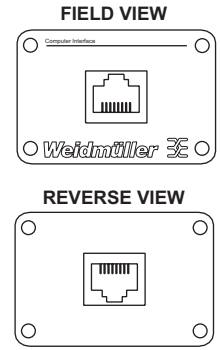

Insert + Housing:
Catalog # 7940000241

RJ45 - CAT5 Interface
Housing Size: 3

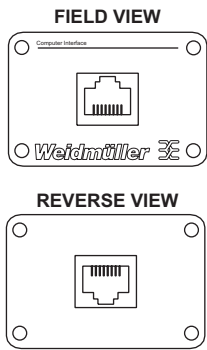

Insert + Housing:
Catalog # 7940000242

RJ12 6 pole Interface
Housing Size: 3

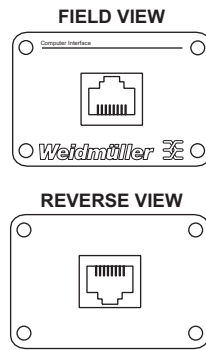

Insert + Housing:
Catalog # 7940000243

RJ45 + AC Interface
Housing Size: 6

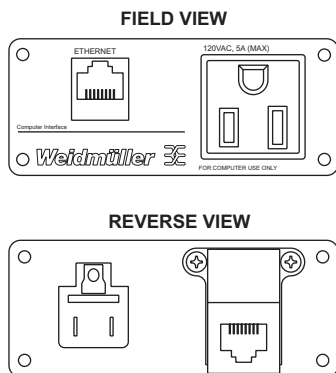

Insert + Housing:
Catalog #7940000234

RJ45 (CAT5) + AC Interface
Ethernet
Housing Size: 6

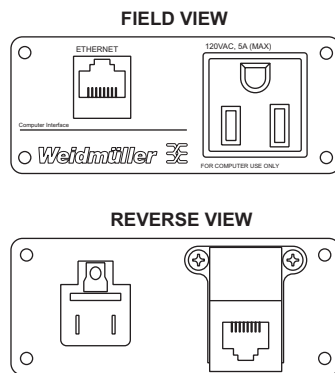

Insert + Housing:
Catalog # 7940000235

RJ12 6 pole + AC Interface
Housing Size: 6

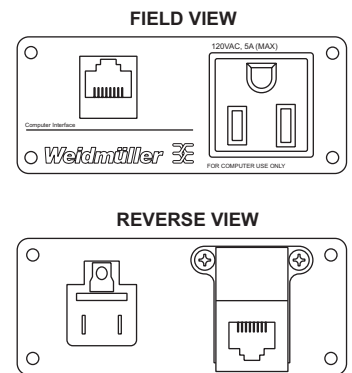

Insert + Housing:
Catalog # 7940000236

PS2 Keyboard & Mouse Ports
Housing Size: 3

FIELD VIEW

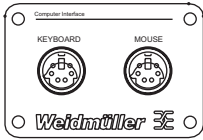

REVERSE VIEW

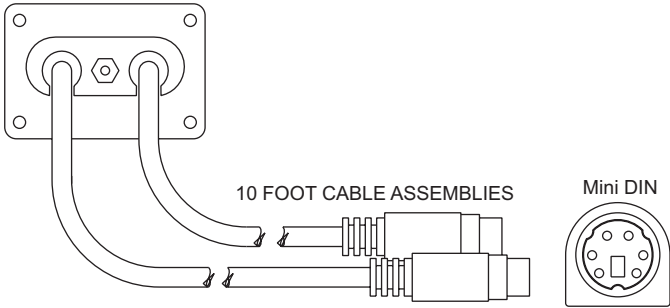

Insert + Housing:
Catalog # 7940000253

AC + 5A Circuit Breaker
Housing Size: 6

FIELD VIEW

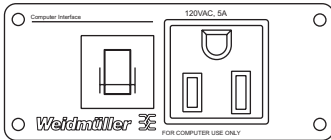

REVERSE VIEW

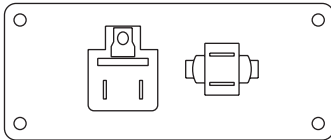

Insert + housing:
Catalog #: 7940000233

AC OUTLET
Housing Size: 3

FIELD VIEW

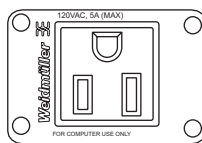

REVERSE VIEW

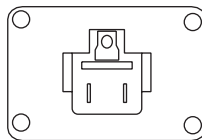

Insert + housing:
Catalog #: 7940000232



Proport™ for Current Loop Measurement

Specifications	
Wire Size	22 - 14 AWG
Meter connection	1/8" phone jack (1 per channel) with make-before-break feature so loop is not interrupted
Protection rating	IP65
Catalog number	
4 ch, size 6 housing	792662 0004
8 ch, size 10 housing	792662 0008
1 Meter test cable	991785 1000

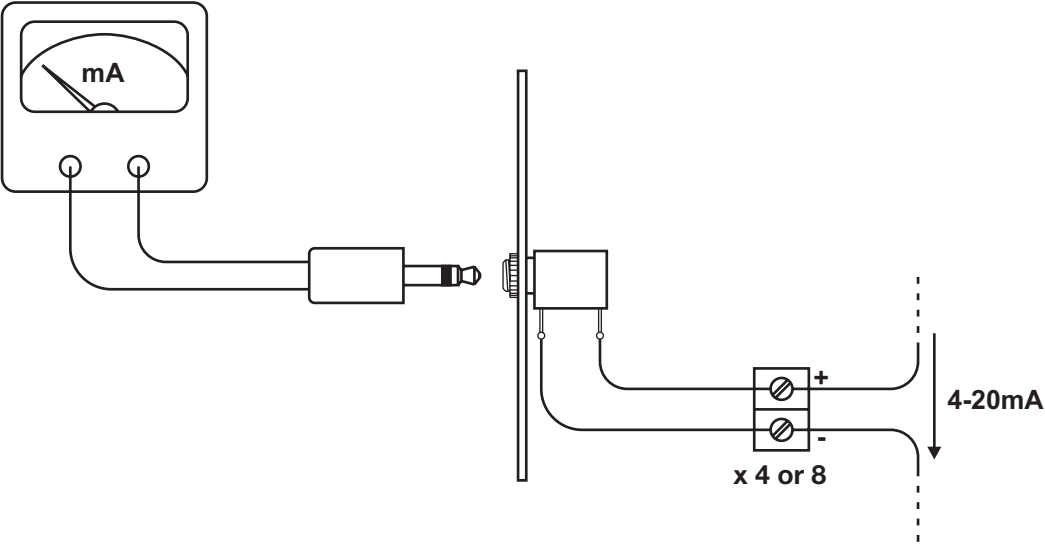

Housing Size: 3

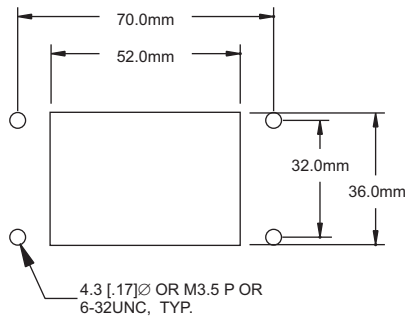
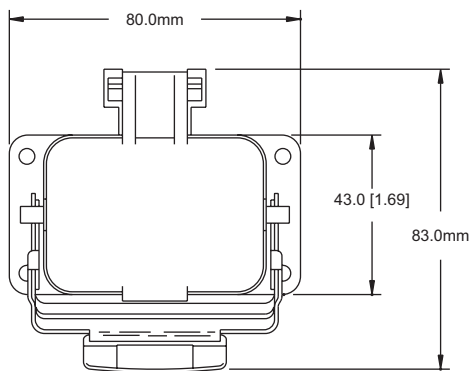

Housing Size: 6

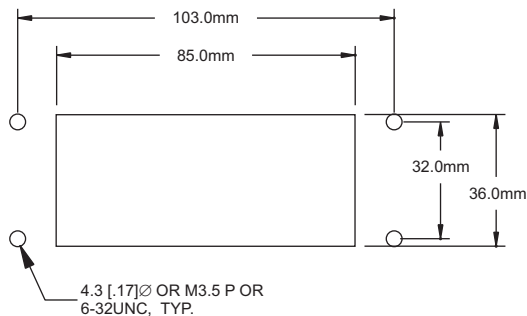
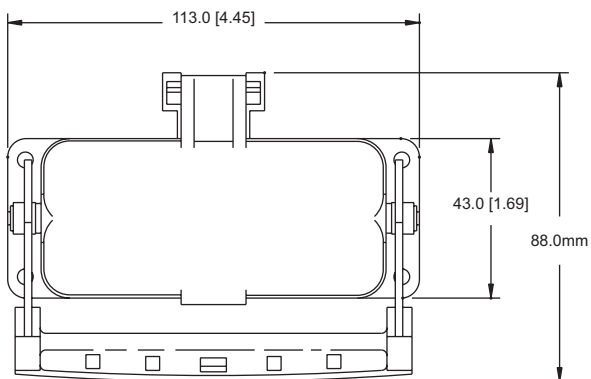

Housing Size: 8

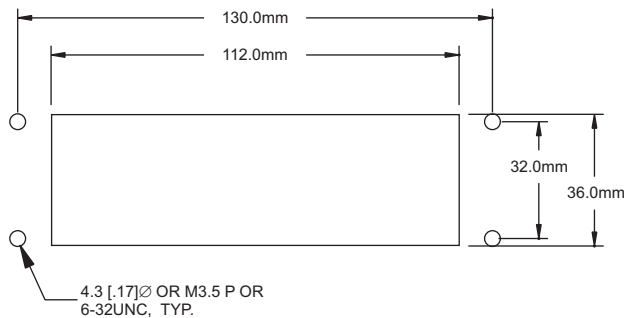
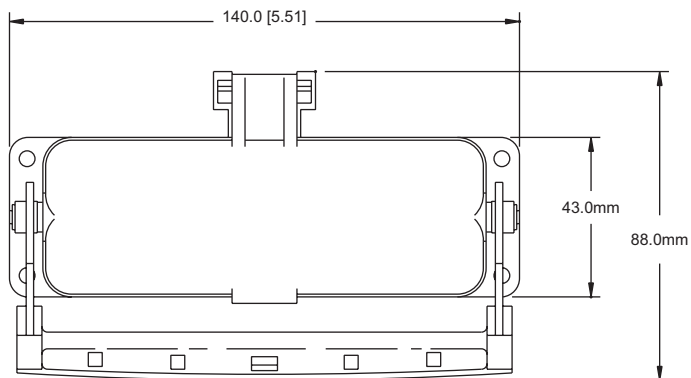

Housing Size: 10

