

## Data sheet | Item number: 859-793

Optocoupler module; Nominal input voltage: 5 VDC; Output voltage range: 3 ... 60 VDC; Limiting continuous current: 0.1 A; 2-wire connection; Module width: 6 mm; gray

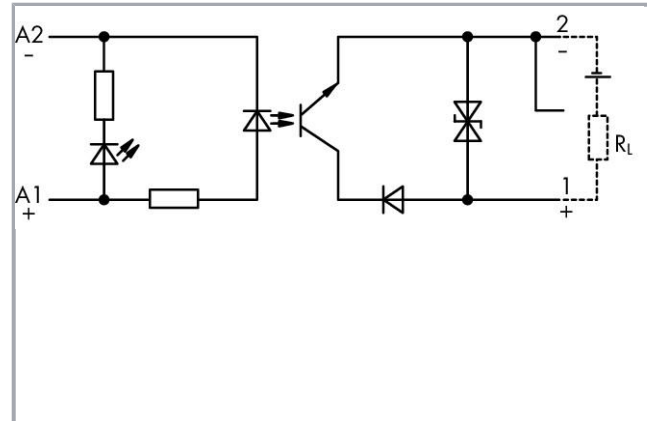

[www.wago.com/859-793](http://www.wago.com/859-793)

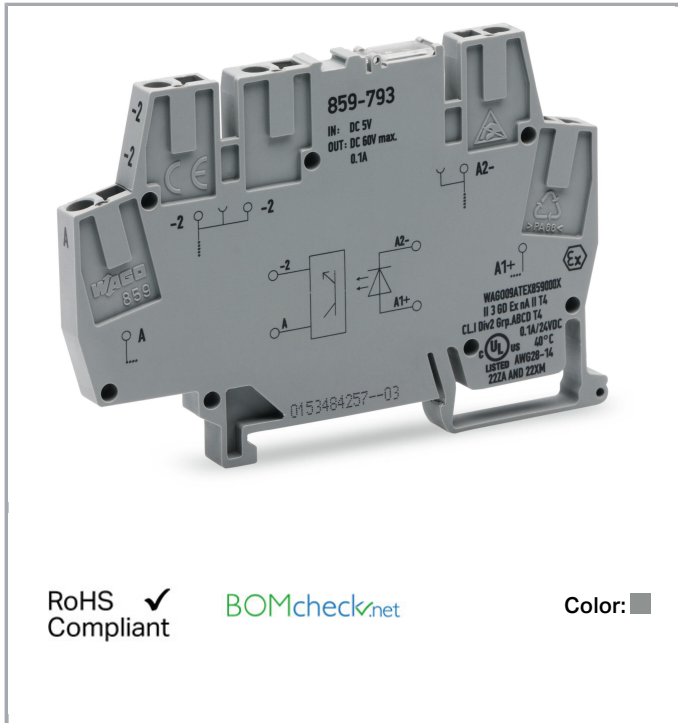

RoHS  Compliant

[BOMcheck.net](https://www.bomcheck.net)

Color: ■

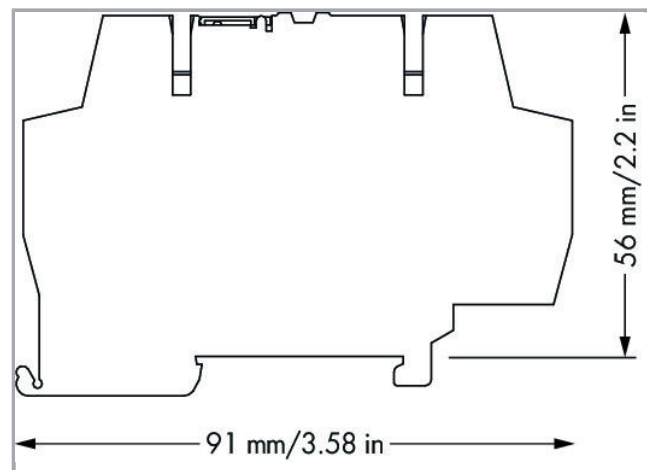
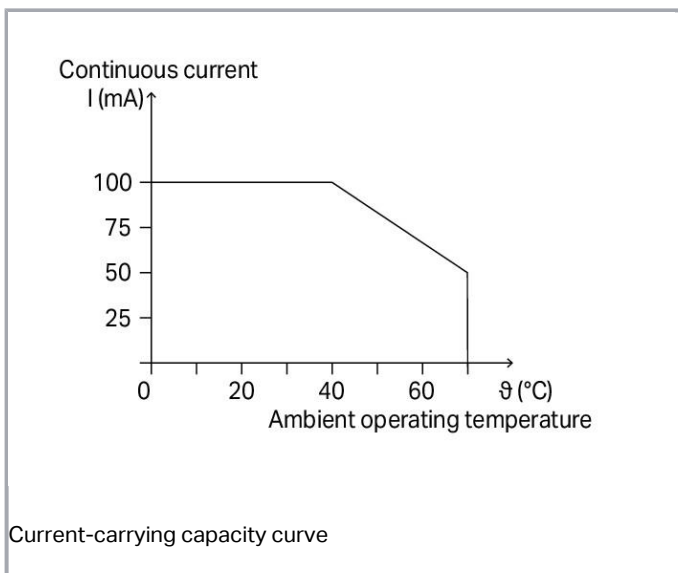

## Item description

Subject to changes.

WAGO Kontakttechnik GmbH & Co. KG  
Hansastr. 27  
32423 Minden  
Phone: +49571 887-0 | Fax: +49571 887-169  
Email: [info.de@wago.com](mailto:info.de@wago.com) | Web: [www.wago.com](http://www.wago.com)

Do you have any questions about our products?  
We are always happy to take your call at +49 (571) 887-44222.

**Note:**

Optocouplers and solid state relays are designed for use in signal processing networks, which are not supplied by the low-voltage power supply networks.

**Data****Technical Data****Control circuit**

Nominal input voltage $U_N$	DC 5 V
Input voltage range (low level)	DC 0 ... 0.8 V
Input voltage range (high level)	DC 2 ... 6.25 V
Nominal input current at $U_N$	7.5 mA

**Load circuit:**

Circuit type	2-conductor termination
Limiting continuous current	0.1 A
Output voltage range	DC 3 ... 60 V
Max. voltage drop at output	$\leq$ DC 2.5 V
Leakage current at nominal voltage	$\leq$ 25 $\mu$ A
Turn-on time	$\leq$ 20 $\mu$ s
Drop-out time	$\leq$ 120 $\mu$ s
Switching frequency	$\leq$ 1.5 kHz

**Signaling**

Status indication	LED red
-------------------	---------

**Safety and protection:**

Dielectric strength, control/load circuit (AC, 1 min)	2.5 kVrms
---	-----------

**Connection data**

Connection technology	CAGE CLAMP®
Solid conductor	0.08 ... 2.5 mm <sup>2</sup> / 28 ... 14 AWG
Fine-stranded conductor	0.08 ... 2.5 mm <sup>2</sup> / 28 ... 14 AWG
Strip length	5 ... 6 mm / 0.2 ... 0.24 inch

Subject to changes.



## Geometrical Data

Width	6 mm / 0.236 inch
Height from upper-edge of DIN-35 rail	56 mm / 2.205 inch
Depth	91 mm / 3.583 inch

## Mechanical data

Type of mounting	DIN-35 rail
------------------	-------------

## Material Data

Color	gray
Fire load	0.483 MJ
Weight	17.9 g

## Environmental Requirements

Surrounding air (operating) temperature at $U_N$	-40 ... 70 °C
Surrounding air (storage) temperature	-40 ... 70 °C
Processing temperature	-25 ... +50 °C

## Standards and specifications

Standards/specifications	EN 60664-1; EN 61000-6-2; EN 61000-6-3; EN 50121-3-2; EN 61373; UL 508
--------------------------	--

## Commercial data

Product Group	6 (Interface Electronics)
Packaging type	BOX
Country of origin	DE
GTIN	4055143606271
Customs Tariff No.	85365005000

## Approvals / Certificates

### UL-Approvals

Logo	Approval	Additional Approval Text	Certificate name
	<b>UL</b>	UL 508	E175199
	UL International Netherlands B.V. (ORDINARY)		Sec.4

Subject to changes.



LOCATIONS)

## Compatible products

### End plate

**Item no.: 859-525**

End and intermediate plate; 1 mm thick; gray

[www.wago.com/859-525](http://www.wago.com/859-525)

### ferrule

**Item no.: 216-221**Ferrule; Sleeve for 0.5 mm<sup>2</sup> / 20 AWG; insulated; electro-tin plated; white[www.wago.com/216-221](http://www.wago.com/216-221)**Item no.: 216-222**Ferrule; Sleeve for 0.75 mm<sup>2</sup> / 18 AWG; insulated; electro-tin plated; gray[www.wago.com/216-222](http://www.wago.com/216-222)**Item no.: 216-223**Ferrule; Sleeve for 1 mm<sup>2</sup> / AWG 18; insulated; electro-tin plated; red[www.wago.com/216-223](http://www.wago.com/216-223)**Item no.: 216-224**Ferrule; Sleeve for 1.5 mm<sup>2</sup> / AWG 16; insulated; electro-tin plated; black[www.wago.com/216-224](http://www.wago.com/216-224)**Item no.: 216-321**Ferrule; Sleeve for 0.25 mm<sup>2</sup> / AWG 24; insulated; electro-tin plated; yellow[www.wago.com/216-321](http://www.wago.com/216-321)**Item no.: 216-322**Ferrule; Sleeve for 0.34 mm<sup>2</sup> / 22 AWG; insulated; electro-tin plated; green[www.wago.com/216-322](http://www.wago.com/216-322)

### Jumper

**Item no.: 859-402**

Push-in type jumper bar; 2-way; Nominal current 18 A; insulated; light gray

[www.wago.com/859-402](http://www.wago.com/859-402)**Item no.: 859-402/000-005**

Push-in type jumper bar; 2-way; Nominal current 18 A; insulated; red

[www.wago.com/859-402/000-005](http://www.wago.com/859-402/000-005)**Item no.: 859-402/000-006**

Push-in type jumper bar; 2-way; Nominal current 18 A; insulated; blue

[www.wago.com/859-402/000-006](http://www.wago.com/859-402/000-006)**Item no.: 859-402/000-029**

Push-in type jumper bar; 2-way; Nominal current 18 A; insulated; yellow

[www.wago.com/859-402/000-029](http://www.wago.com/859-402/000-029)

Subject to changes.

WAGO Kontakttechnik GmbH &amp; Co. KG

Hansastr. 27















32423 Minden

Phone: +49571 887-0 | Fax: +49571 887-169

Email: [info.de@wago.com](mailto:info.de@wago.com) | Web: [www.wago.com](http://www.wago.com)

Do you have any questions about our products?

We are always happy to take your call at +49 (571) 887-44222.

	<b>Item no.: 859-403</b> Push-in type jumper bar; 3-way; Nominal current 18 A; insulated; light gray	<a href="http://www.wago.com/859-403">www.wago.com/859-403</a>
	<b>Item no.: 859-403/000-005</b> Push-in type jumper bar; 3-way; Nominal current 18 A; insulated; red	<a href="http://www.wago.com/859-403/000-005">www.wago.com/859-403/000-005</a>
	<b>Item no.: 859-403/000-006</b> Push-in type jumper bar; 3-way; Nominal current 18 A; insulated; blue	<a href="http://www.wago.com/859-403/000-006">www.wago.com/859-403/000-006</a>
	<b>Item no.: 859-403/000-029</b> Push-in type jumper bar; 3-way; Nominal current 18 A; insulated; yellow	<a href="http://www.wago.com/859-403/000-029">www.wago.com/859-403/000-029</a>
	<b>Item no.: 859-404</b> Push-in type jumper bar; 4-way; Nominal current 18 A; insulated; light gray	<a href="http://www.wago.com/859-404">www.wago.com/859-404</a>
	<b>Item no.: 859-404/000-005</b> Push-in type jumper bar; 4-way; Nominal current 18 A; insulated; red	<a href="http://www.wago.com/859-404/000-005">www.wago.com/859-404/000-005</a>
	<b>Item no.: 859-404/000-006</b> Push-in type jumper bar; 4-way; Nominal current 18 A; insulated; blue	<a href="http://www.wago.com/859-404/000-006">www.wago.com/859-404/000-006</a>
	<b>Item no.: 859-404/000-029</b> Push-in type jumper bar; 4-way; Nominal current 18 A; insulated; yellow	<a href="http://www.wago.com/859-404/000-029">www.wago.com/859-404/000-029</a>
	<b>Item no.: 859-405</b> Push-in type jumper bar; 5-way; Nominal current 18 A; insulated; light gray	<a href="http://www.wago.com/859-405">www.wago.com/859-405</a>
	<b>Item no.: 859-405/000-005</b> Push-in type jumper bar; 5-way; Nominal current 18 A; insulated; red	<a href="http://www.wago.com/859-405/000-005">www.wago.com/859-405/000-005</a>
	<b>Item no.: 859-405/000-006</b> Push-in type jumper bar; 5-way; Nominal current 18 A; insulated; blue	<a href="http://www.wago.com/859-405/000-006">www.wago.com/859-405/000-006</a>
	<b>Item no.: 859-405/000-029</b> Push-in type jumper bar; 5-way; Nominal current 18 A; insulated; yellow	<a href="http://www.wago.com/859-405/000-029">www.wago.com/859-405/000-029</a>
	<b>Item no.: 859-406</b> Push-in type jumper bar; 6-way; Nominal current 18 A; insulated; light gray	<a href="http://www.wago.com/859-406">www.wago.com/859-406</a>
	<b>Item no.: 859-406/000-005</b> Push-in type jumper bar; 6-way; Nominal current 18 A; insulated; red	<a href="http://www.wago.com/859-406/000-005">www.wago.com/859-406/000-005</a>

Subject to changes.



**Item no.: 859-406/000-006**  
Push-in type jumper bar; 6-way; Nominal current 18 A; insulated; blue

[www.wago.com/859-406/000-006](http://www.wago.com/859-406/000-006)



**Item no.: 859-406/000-029**  
Push-in type jumper bar; 6-way; Nominal current 18 A; insulated; yellow

[www.wago.com/859-406/000-029](http://www.wago.com/859-406/000-029)



**Item no.: 859-407**  
Push-in type jumper bar; 7-way; Nominal current 18 A; insulated; light gray

[www.wago.com/859-407](http://www.wago.com/859-407)



**Item no.: 859-407/000-005**  
Push-in type jumper bar; 7-way; Nominal current 18 A; insulated; red

[www.wago.com/859-407/000-005](http://www.wago.com/859-407/000-005)



**Item no.: 859-407/000-006**  
Push-in type jumper bar; 7-way; Nominal current 18 A; insulated; blue

[www.wago.com/859-407/000-006](http://www.wago.com/859-407/000-006)



**Item no.: 859-407/000-029**  
Push-in type jumper bar; 7-way; Nominal current 18 A; insulated; yellow

[www.wago.com/859-407/000-029](http://www.wago.com/859-407/000-029)



**Item no.: 859-408**  
Push-in type jumper bar; 8-way; Nominal current 18 A; insulated; light gray

[www.wago.com/859-408](http://www.wago.com/859-408)



**Item no.: 859-408/000-005**  
Push-in type jumper bar; 8-way; Nominal current 18 A; insulated; red

[www.wago.com/859-408/000-005](http://www.wago.com/859-408/000-005)



**Item no.: 859-408/000-006**  
Push-in type jumper bar; 8-way; Nominal current 18 A; insulated; blue

[www.wago.com/859-408/000-006](http://www.wago.com/859-408/000-006)



**Item no.: 859-408/000-029**  
Push-in type jumper bar; 8-way; Nominal current 18 A; insulated; yellow

[www.wago.com/859-408/000-029](http://www.wago.com/859-408/000-029)



**Item no.: 859-409**  
Push-in type jumper bar; 9-way; Nominal current 18 A; insulated; light gray

[www.wago.com/859-409](http://www.wago.com/859-409)



**Item no.: 859-409/000-005**  
Push-in type jumper bar; 9-way; Nominal current 18 A; insulated; red

[www.wago.com/859-409/000-005](http://www.wago.com/859-409/000-005)



**Item no.: 859-409/000-006**  
Push-in type jumper bar; 9-way; Nominal current 18 A; insulated; blue

[www.wago.com/859-409/000-006](http://www.wago.com/859-409/000-006)



**Item no.: 859-409/000-029**  
Push-in type jumper bar; 9-way; Nominal current 18 A; insulated; yellow

[www.wago.com/859-409/000-029](http://www.wago.com/859-409/000-029)

**Item no.: 859-410**

Subject to changes.



Push-in type jumper bar; 10-way; Nominal current 18 A; insulated; light gray

[www.wago.com/859-410](http://www.wago.com/859-410)



**Item no.: 859-410/000-005**  
Push-in type jumper bar; 10-way; Nominal current 18 A; insulated; red

[www.wago.com/859-410/000-005](http://www.wago.com/859-410/000-005)



**Item no.: 859-410/000-006**  
Push-in type jumper bar; 10-way; Nominal current 18 A; insulated; blue

[www.wago.com/859-410/000-006](http://www.wago.com/859-410/000-006)



**Item no.: 859-410/000-029**  
Push-in type jumper bar; 10-way; Nominal current 18 A; insulated; yellow

[www.wago.com/859-410/000-029](http://www.wago.com/859-410/000-029)

**tools**



**Item no.: 210-720**  
Operating tool; Blade: 3.5 x 0.5 mm; with a partially insulated shaft

[www.wago.com/210-720](http://www.wago.com/210-720)

**check**



**Item no.: 859-500**  
Test pin; 1 mm Ø; with solder connection for test wire

[www.wago.com/859-500](http://www.wago.com/859-500)

**Marking accessories**



**Item no.: 2009-145**  
Mini-WSB Inline; for Smart Printer; on reel; stretchable 5 - 5.2 mm; plain; snap-on type; white

[www.wago.com/2009-145](http://www.wago.com/2009-145)



**Item no.: 2009-145/000-002**  
Mini-WSB Inline; for Smart Printer; on reel; stretchable 5 - 5.2 mm; plain; snap-on type; yellow

[www.wago.com/2009-145/000-002](http://www.wago.com/2009-145/000-002)



**Item no.: 2009-145/000-005**  
Mini-WSB Inline; for Smart Printer; on reel; stretchable 5 - 5.2 mm; plain; snap-on type; red

[www.wago.com/2009-145/000-005](http://www.wago.com/2009-145/000-005)



**Item no.: 2009-145/000-006**  
Mini-WSB Inline; for Smart Printer; on reel; stretchable 5 - 5.2 mm; plain; snap-on type; blue

[www.wago.com/2009-145/000-006](http://www.wago.com/2009-145/000-006)



**Item no.: 2009-145/000-007**  
Mini-WSB Inline; for Smart Printer; on reel; stretchable 5 - 5.2 mm; plain; snap-on type; gray

[www.wago.com/2009-145/000-007](http://www.wago.com/2009-145/000-007)



**Item no.: 2009-145/000-012**  
Mini-WSB Inline; for Smart Printer; on reel; stretchable 5 - 5.2 mm; plain; snap-on type; orange















[www.wago.com/2009-145/000-012](http://www.wago.com/2009-145/000-012)



**Item no.: 2009-145/000-023**  
Mini-WSB Inline; for Smart Printer; on reel; stretchable 5 - 5.2 mm; plain; snap-on type; green





[www.wago.com/2009-145/000-023](http://www.wago.com/2009-145/000-023)

Subject to changes.

	<p><b>Item no.: 2009-145/000-024</b>                  Mini-WSB Inline; for Smart Printer; on reel; stretchable 5 - 5.2 mm; plain; snap-on type; violet</p>	<a href="http://www.wago.com/2009-145/000-024">www.wago.com/2009-145/000-024</a>
	<p><b>Item no.: 210-110</b>                  Fiber-tip pen</p>	<a href="http://www.wago.com/210-110">www.wago.com/210-110</a>
	<p><b>Item no.: 248-501</b>                  Miniature WSB Quick marking system; plain; Marker width 5 mm; 10 strips with 10 markers per card</p>	<a href="http://www.wago.com/248-501">www.wago.com/248-501</a>
	<p><b>Item no.: 248-501/000-002</b>                  Mini-WSB marking card; as card; not stretchable; plain; snap-on type; yellow</p>	<a href="http://www.wago.com/248-501/000-002">www.wago.com/248-501/000-002</a>
	<p><b>Item no.: 248-501/000-005</b>                  Mini-WSB marking card; as card; not stretchable; plain; snap-on type; red</p>	<a href="http://www.wago.com/248-501/000-005">www.wago.com/248-501/000-005</a>
	<p><b>Item no.: 248-501/000-006</b>                  Mini-WSB marking card; as card; not stretchable; plain; snap-on type; blue</p>	<a href="http://www.wago.com/248-501/000-006">www.wago.com/248-501/000-006</a>
	<p><b>Item no.: 248-501/000-007</b>                  Mini-WSB marking card; as card; not stretchable; plain; snap-on type; gray</p>	<a href="http://www.wago.com/248-501/000-007">www.wago.com/248-501/000-007</a>
	<p><b>Item no.: 248-501/000-012</b>                  Mini-WSB marking card; as card; not stretchable; plain; snap-on type; orange</p>	<a href="http://www.wago.com/248-501/000-012">www.wago.com/248-501/000-012</a>
	<p><b>Item no.: 248-501/000-017</b>                  Mini-WSB marking card; as card; not stretchable; plain; snap-on type; light green</p>	<a href="http://www.wago.com/248-501/000-017">www.wago.com/248-501/000-017</a>
	<p><b>Item no.: 248-501/000-023</b>                  Mini-WSB marking card; as card; not stretchable; plain; snap-on type; green</p>	<a href="http://www.wago.com/248-501/000-023">www.wago.com/248-501/000-023</a>
	<p><b>Item no.: 248-501/000-024</b>                  Mini-WSB marking card; as card; not stretchable; plain; snap-on type; violet</p>	<a href="http://www.wago.com/248-501/000-024">www.wago.com/248-501/000-024</a>
	<p><b>Item no.: 248-502</b>                  Mini-WSB marking card; as card; MARKED; 1 ... 10 (10x); not stretchable; Horizontal marking; snap-on type; white</p>	<a href="http://www.wago.com/248-502">www.wago.com/248-502</a>
	<p><b>Item no.: 248-502/000-024</b>                  Mini-WSB marking card; as card; MARKED; 1 ... 10 (10x); not stretchable; Horizontal marking; snap-on type; violet</p>	<a href="http://www.wago.com/248-502/000-024">www.wago.com/248-502/000-024</a>
	<p><b>Item no.: 248-503</b>                  Mini-WSB marking card; as card; MARKED; 11 ... 20 (10x); not stretchable; Horizontal marking; snap-on type; white</p>	<a href="http://www.wago.com/248-503">www.wago.com/248-503</a>

Subject to changes.



	<b>Item no.: 248-503/000-024</b> Mini-WSB marking card; as card; MARKED; 11 ... 20 (10x); not stretchable; Horizontal marking; snap-on type; violet	<a href="http://www.wago.com/248-503/000-024">www.wago.com/248-503/000-024</a>
	<b>Item no.: 248-504</b> Mini-WSB marking card; as card; MARKED; 21 ... 30 (10x); not stretchable; Horizontal marking; snap-on type; white	<a href="http://www.wago.com/248-504">www.wago.com/248-504</a>
	<b>Item no.: 248-504/000-024</b> Mini-WSB marking card; as card; MARKED; 21 ... 30 (10x); not stretchable; Horizontal marking; snap-on type; violet	<a href="http://www.wago.com/248-504/000-024">www.wago.com/248-504/000-024</a>
	<b>Item no.: 248-505/000-024</b> Mini-WSB marking card; as card; MARKED; 31 ... 40 (10x); not stretchable; Horizontal marking; snap-on type; violet	<a href="http://www.wago.com/248-505/000-024">www.wago.com/248-505/000-024</a>
	<b>Item no.: 248-506</b> Mini-WSB marking card; as card; MARKED; 41 ... 50 (10x); not stretchable; Horizontal marking; snap-on type; white	<a href="http://www.wago.com/248-506">www.wago.com/248-506</a>

## Downloads

### Documentation

#### Bid Text

859-793 docx - Datei	Feb 20, 2019	docx 15.6 kB	Download
859-793 X81 - Datei	Feb 19, 2019	xml 4.0 kB	Download

#### Instruction Leaflet

Relay modules, Optocoupler modules	V 1.2.0 Aug 30, 2019	pdf 2.2 MB	Download
------------------------------------	-------------------------	---------------	----------

#### Additional Information

Disposal; Electrical and electronic equipment, Packaging	V 1.0.0	pdf 265.8 kB	Download
--	---------	-----------------	----------

## CAD/CAE-Data

### CAD data

2D/3D Models 859-793	URL	Download
----------------------	-----	----------

### CAE data

Subject to changes.

EPLAN Data Portal 859-793

[Download](#)

WSCAD Universe 859-793

[Download](#)

## Installation Notes

### Inserting a conductor

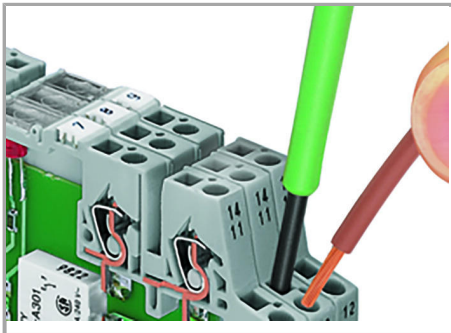

Connection of conductor

### Jumpered

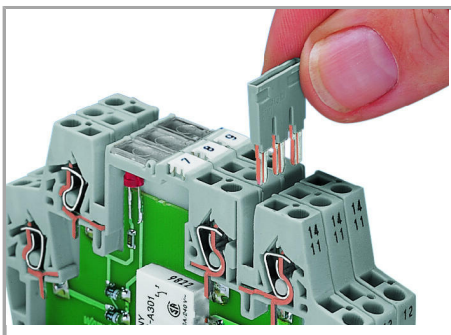

Easy commoning using adjacent jumpers

### Marking

Subject to changes.



Marking using miniature WSB quick marking card

Subject to changes.