

Data sheet | Item number: 859-304

Relay module; Nominal input voltage: 24 VDC; 1 changeover contact; Red status indicator; Module width: 6 mm; 2,50 mm²; gray

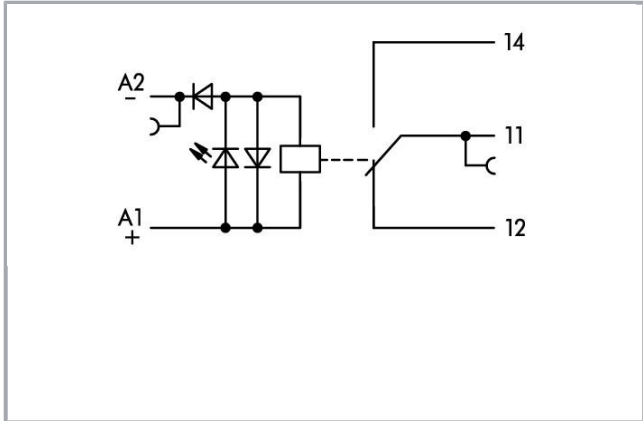

www.wago.com/859-304

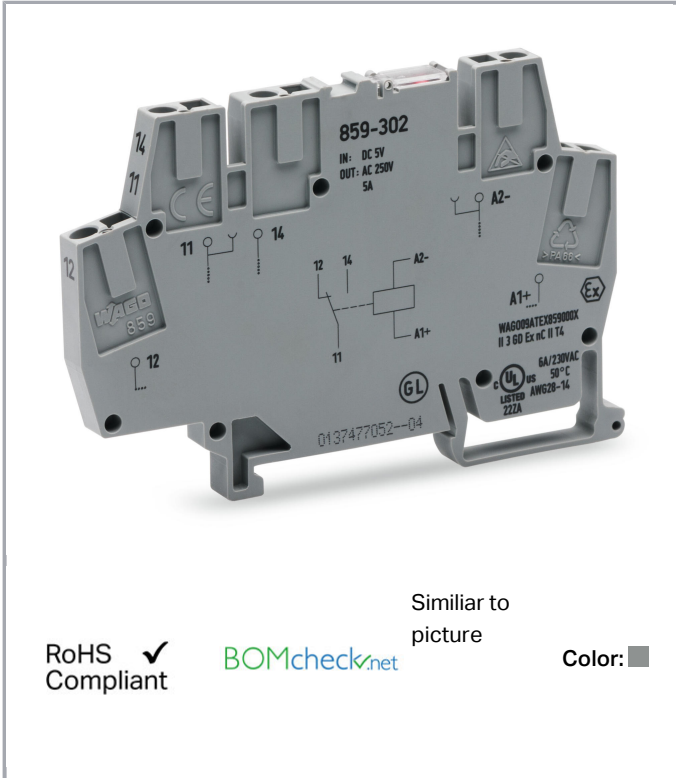

RoHS Compliant

BOMcheck.net

Similar to picture

Color: ■

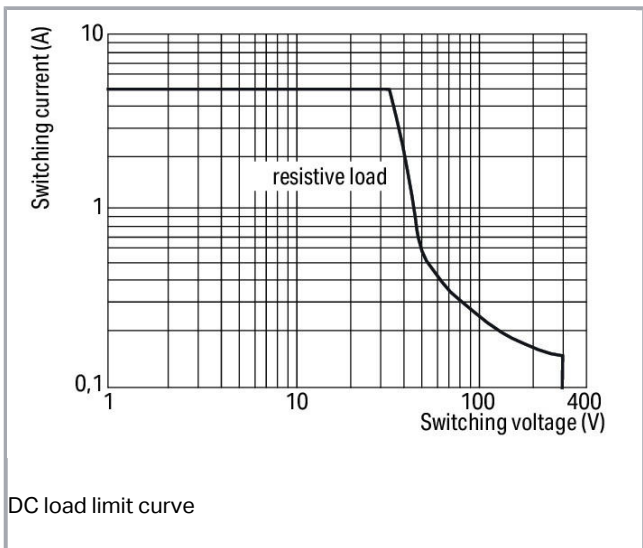
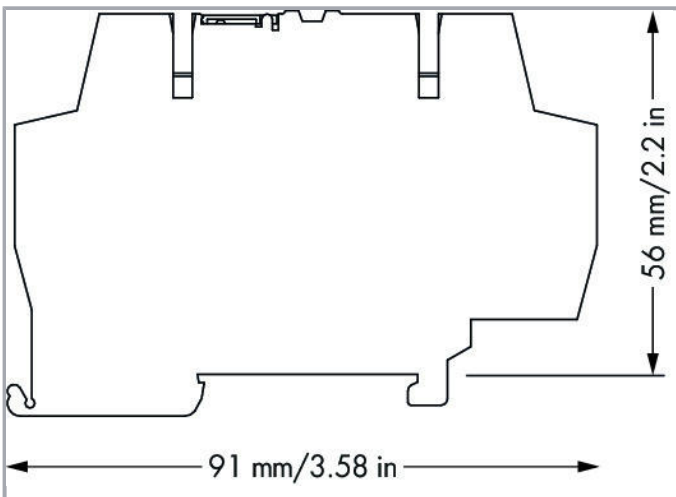

Subject to changes.

WAGO Kontakttechnik GmbH & Co. KG
Hansastr. 27
32423 Minden
Phone: +49571 887-0 | Fax: +49571 887-169
Email: info.de@wago.com | Web: www.wago.com

Do you have any questions about our products?
We are always happy to take your call at +49 (571) 887-44222.

Item description

Note:

Inductive loads have to be attenuated by an appropriate protective circuit in order to protect relay coils and contacts.

Data

Technical Data

Control circuit

Nominal input voltage U_N	DC 24 V
Input voltage range	-15 ... +20 %
Nominal input current at U_N	10 mA

Load circuit:

Number of changeover/switchover contacts	1
Contact material (relay)	AgSnO ₂
Limiting continuous current	5 A
Max. make current (resistive)	(AC) 20 A / 0.02 s
Max. switching voltage	AC 250 V
Max. switching power (resistive)	AC 1250 VA; DC see load limit curve
Recommended minimum load	10 V / 10 mA; 24 V / 1 mA
Pull-in time (typ.)	15 ms
Drop-out time (typ.)	25 ms
Bounce time (typ.)	3.5 ms
Electrical life (N.O.; resistive load; 23 °C)	50 x 10 ³ switching operations
Mechanical life	5 x 10 ⁶ switching operations
Max. switching load with load/without load	6 min ⁻¹ / 180 min ⁻¹

Signaling

Status indication	LED red
-------------------	---------

Safety and protection:

Rated voltage	250 V
---------------	-------

Subject to changes.



Rated impulse voltage	4 kV
Pollution degree	2
Dielectric strength, control/load circuit (AC, 1 min)	4 kVrms
Dielectric strength open contact (AC, 1 min)	1 kVrms

Connection data

Connection technology	CAGE CLAMP®
Solid conductor	0.08 ... 2.5 mm ² / 28 ... 14 AWG
Fine-stranded conductor	0.08 ... 2.5 mm ² / 28 ... 14 AWG
Strip length	5 ... 6 mm / 0.2 ... 0.24 inch

Geometrical Data

Width	6 mm / 0.236 inch
Height from upper-edge of DIN-35 rail	56 mm / 2.205 inch
Depth	91 mm / 3.583 inch

Mechanical data

Type of mounting	DIN-35 rail
------------------	-------------

Material Data

Color	gray
Weight	22.9 g

Environmental Requirements

Surrounding air (operating) temperature at U _N	-40 ... 50 °C
Surrounding air (storage) temperature	-40 ... 70 °C
Processing temperature	-25 ... +50 °C

Standards and specifications

Standards/specifications	EN 61010-2-201; EN 61810-1; EN 61373; GL; UL 508
--------------------------	--

Commercial data

Product Group	6 (Interface Electronics)
Packaging type	BOX
Country of origin	CN

Subject to changes.



WAGO Kontakttechnik GmbH & Co. KG
 Hansastr. 27
 32423 Minden
 Phone: +49571 887-0 | Fax: +49571 887-169
 Email: info.de@wago.com | Web: www.wago.com

Do you have any questions about our products?
 We are always happy to take your call at +49 (571) 887-44222.

GTIN	4055143606769
Customs Tariff No.	85364900990

Approvals / Certificates

Ship Approvals



Logo	Approval	Additional Approval Text	Certificate name
	DNV GL Det Norske Veritas, Germanischer Lloyd	-	TAA00001D1
	NK Nippon Kaiji Kyokai	-	TA17255M
	PRS Polski Rejestr Statków	-	TE/2186 /880590/18

UL-Approvals

Logo	Approval	Additional Approval Text	Certificate name
	UL UL International Netherlands B.V. (ORDINARY LOCATIONS)	UL 508	E175199 Sec.4

Compatible products

Jumper

	Item no.: 859-402 Push-in type jumper bar; 2-way; Nominal current 18 A; insulated; light gray	www.wago.com/859-402
	Item no.: 859-402/000-005 Push-in type jumper bar; 2-way; Nominal current 18 A; insulated; red	www.wago.com/859-402/000-005

Subject to changes.



Item no.: 859-402/000-006
Push-in type jumper bar; 2-way; Nominal current 18 A; insulated; blue

www.wago.com/859-402/000-006



Item no.: 859-402/000-029
Push-in type jumper bar; 2-way; Nominal current 18 A; insulated; yellow

www.wago.com/859-402/000-029



Item no.: 859-403
Push-in type jumper bar; 3-way; Nominal current 18 A; insulated; light gray

www.wago.com/859-403



Item no.: 859-403/000-005
Push-in type jumper bar; 3-way; Nominal current 18 A; insulated; red

www.wago.com/859-403/000-005



Item no.: 859-403/000-006
Push-in type jumper bar; 3-way; Nominal current 18 A; insulated; blue

www.wago.com/859-403/000-006



Item no.: 859-403/000-029
Push-in type jumper bar; 3-way; Nominal current 18 A; insulated; yellow

www.wago.com/859-403/000-029



Item no.: 859-404
Push-in type jumper bar; 4-way; Nominal current 18 A; insulated; light gray

www.wago.com/859-404



Item no.: 859-404/000-005
Push-in type jumper bar; 4-way; Nominal current 18 A; insulated; red

www.wago.com/859-404/000-005



Item no.: 859-404/000-006
Push-in type jumper bar; 4-way; Nominal current 18 A; insulated; blue

www.wago.com/859-404/000-006



Item no.: 859-404/000-029
Push-in type jumper bar; 4-way; Nominal current 18 A; insulated; yellow

www.wago.com/859-404/000-029



Item no.: 859-405
Push-in type jumper bar; 5-way; Nominal current 18 A; insulated; light gray

www.wago.com/859-405



Item no.: 859-405/000-005
Push-in type jumper bar; 5-way; Nominal current 18 A; insulated; red

www.wago.com/859-405/000-005



Item no.: 859-405/000-006
Push-in type jumper bar; 5-way; Nominal current 18 A; insulated; blue

www.wago.com/859-405/000-006

















Item no.: 859-405/000-029
Push-in type jumper bar; 5-way; Nominal current 18 A; insulated; yellow











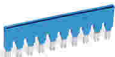

www.wago.com/859-405/000-029

Item no.: 859-406

Subject to changes.

	Push-in type jumper bar; 6-way; Nominal current 18 A; insulated; light gray	www.wago.com/859-406
	Item no.: 859-406/000-005 Push-in type jumper bar; 6-way; Nominal current 18 A; insulated; red	www.wago.com/859-406/000-005
	Item no.: 859-406/000-006 Push-in type jumper bar; 6-way; Nominal current 18 A; insulated; blue	www.wago.com/859-406/000-006
	Item no.: 859-406/000-029 Push-in type jumper bar; 6-way; Nominal current 18 A; insulated; yellow	www.wago.com/859-406/000-029
	Item no.: 859-407 Push-in type jumper bar; 7-way; Nominal current 18 A; insulated; light gray	www.wago.com/859-407
	Item no.: 859-407/000-005 Push-in type jumper bar; 7-way; Nominal current 18 A; insulated; red	www.wago.com/859-407/000-005
	Item no.: 859-407/000-006 Push-in type jumper bar; 7-way; Nominal current 18 A; insulated; blue	www.wago.com/859-407/000-006
	Item no.: 859-407/000-029 Push-in type jumper bar; 7-way; Nominal current 18 A; insulated; yellow	www.wago.com/859-407/000-029
	Item no.: 859-408 Push-in type jumper bar; 8-way; Nominal current 18 A; insulated; light gray	www.wago.com/859-408
	Item no.: 859-408/000-005 Push-in type jumper bar; 8-way; Nominal current 18 A; insulated; red	www.wago.com/859-408/000-005
	Item no.: 859-408/000-006 Push-in type jumper bar; 8-way; Nominal current 18 A; insulated; blue	www.wago.com/859-408/000-006
	Item no.: 859-408/000-029 Push-in type jumper bar; 8-way; Nominal current 18 A; insulated; yellow	www.wago.com/859-408/000-029
	Item no.: 859-409 Push-in type jumper bar; 9-way; Nominal current 18 A; insulated; light gray	www.wago.com/859-409
	Item no.: 859-409/000-005 Push-in type jumper bar; 9-way; Nominal current 18 A; insulated; red	www.wago.com/859-409/000-005













Subject to changes.

	Item no.: 859-409/000-006 Push-in type jumper bar; 9-way; Nominal current 18 A; insulated; blue	www.wago.com/859-409/000-006
	Item no.: 859-409/000-029 Push-in type jumper bar; 9-way; Nominal current 18 A; insulated; yellow	www.wago.com/859-409/000-029
	Item no.: 859-410 Push-in type jumper bar; 10-way; Nominal current 18 A; insulated; light gray	www.wago.com/859-410
	Item no.: 859-410/000-005 Push-in type jumper bar; 10-way; Nominal current 18 A; insulated; red	www.wago.com/859-410/000-005
	Item no.: 859-410/000-006 Push-in type jumper bar; 10-way; Nominal current 18 A; insulated; blue	www.wago.com/859-410/000-006
	Item no.: 859-410/000-029 Push-in type jumper bar; 10-way; Nominal current 18 A; insulated; yellow	www.wago.com/859-410/000-029
ferrule		
	Item no.: 216-221 Ferrule; Sleeve for 0.5 mm ² / 20 AWG; insulated; electro-tin plated; white	www.wago.com/216-221
	Item no.: 216-222 Ferrule; Sleeve for 0.75 mm ² / 18 AWG; insulated; electro-tin plated; gray	www.wago.com/216-222
	Item no.: 216-223 Ferrule; Sleeve for 1 mm ² / AWG 18; insulated; electro-tin plated; red	www.wago.com/216-223
	Item no.: 216-224 Ferrule; Sleeve for 1.5 mm ² / AWG 16; insulated; electro-tin plated; black	www.wago.com/216-224
	Item no.: 216-321 Ferrule; Sleeve for 0.25 mm ² / AWG 24; insulated; electro-tin plated; yellow	www.wago.com/216-321
	Item no.: 216-322 Ferrule; Sleeve for 0.34 mm ² / 22 AWG; insulated; electro-tin plated; green	www.wago.com/216-322
tools		
	Item no.: 210-720 Operating tool; Blade: 3.5 x 0.5 mm; with a partially insulated shaft	www.wago.com/210-720
End plate		
	Item no.: 859-525 End and intermediate plate; 1 mm thick; gray	www.wago.com/859-525
check		
	Item no.: 859-500 Test pin; 1 mm Ø; with solder connection for test wire	www.wago.com/859-500

Subject to changes.



Marking accessories

	Item no.: 2009-145 Mini-WSB Inline; for Smart Printer; on reel; stretchable 5 - 5.2 mm; plain; snap-on type; white	www.wago.com/2009-145
	Item no.: 2009-145/000-002 Mini-WSB Inline; for Smart Printer; on reel; stretchable 5 - 5.2 mm; plain; snap-on type; yellow	www.wago.com/2009-145/000-002
	Item no.: 2009-145/000-005 Mini-WSB Inline; for Smart Printer; on reel; stretchable 5 - 5.2 mm; plain; snap-on type; red	www.wago.com/2009-145/000-005
	Item no.: 2009-145/000-006 Mini-WSB Inline; for Smart Printer; on reel; stretchable 5 - 5.2 mm; plain; snap-on type; blue	www.wago.com/2009-145/000-006
	Item no.: 2009-145/000-007 Mini-WSB Inline; for Smart Printer; on reel; stretchable 5 - 5.2 mm; plain; snap-on type; gray	www.wago.com/2009-145/000-007
	Item no.: 2009-145/000-012 Mini-WSB Inline; for Smart Printer; on reel; stretchable 5 - 5.2 mm; plain; snap-on type; orange	www.wago.com/2009-145/000-012
	Item no.: 2009-145/000-023 Mini-WSB Inline; for Smart Printer; on reel; stretchable 5 - 5.2 mm; plain; snap-on type; green	www.wago.com/2009-145/000-023
	Item no.: 2009-145/000-024 Mini-WSB Inline; for Smart Printer; on reel; stretchable 5 - 5.2 mm; plain; snap-on type; violet	www.wago.com/2009-145/000-024
	Item no.: 210-110 Fiber-tip pen	www.wago.com/210-110
	Item no.: 248-501 Miniature WSB Quick marking system; plain; Marker width 5 mm; 10 strips with 10 markers per card	www.wago.com/248-501
	Item no.: 248-501/000-002 Mini-WSB marking card; as card; not stretchable; plain; snap-on type; yellow	www.wago.com/248-501/000-002
	Item no.: 248-501/000-005 Mini-WSB marking card; as card; not stretchable; plain; snap-on type; red	www.wago.com/248-501/000-005
	Item no.: 248-501/000-006 Mini-WSB marking card; as card; not stretchable; plain; snap-on type; blue	www.wago.com/248-501/000-006

Subject to changes.



Item no.: 248-501/000-007
Mini-WSB marking card; as card; not stretchable; plain; snap-on type; gray

www.wago.com/248-501/000-007



Item no.: 248-501/000-012
Mini-WSB marking card; as card; not stretchable; plain; snap-on type; orange

www.wago.com/248-501/000-012



Item no.: 248-501/000-017
Mini-WSB marking card; as card; not stretchable; plain; snap-on type; light green

www.wago.com/248-501/000-017



Item no.: 248-501/000-023
Mini-WSB marking card; as card; not stretchable; plain; snap-on type; green

www.wago.com/248-501/000-023



Item no.: 248-501/000-024
Mini-WSB marking card; as card; not stretchable; plain; snap-on type; violet

www.wago.com/248-501/000-024



Item no.: 248-502
Mini-WSB marking card; as card; MARKED; 1 ... 10 (10x); not stretchable; Horizontal marking; snap-on type; white

www.wago.com/248-502



Item no.: 248-502/000-024
Mini-WSB marking card; as card; MARKED; 1 ... 10 (10x); not stretchable; Horizontal marking; snap-on type; violet

www.wago.com/248-502/000-024



Item no.: 248-503
Mini-WSB marking card; as card; MARKED; 11 ... 20 (10x); not stretchable; Horizontal marking; snap-on type; white

www.wago.com/248-503



Item no.: 248-503/000-024
Mini-WSB marking card; as card; MARKED; 11 ... 20 (10x); not stretchable; Horizontal marking; snap-on type; violet

www.wago.com/248-503/000-024



Item no.: 248-504
Mini-WSB marking card; as card; MARKED; 21 ... 30 (10x); not stretchable; Horizontal marking; snap-on type; white

www.wago.com/248-504



Item no.: 248-504/000-024
Mini-WSB marking card; as card; MARKED; 21 ... 30 (10x); not stretchable; Horizontal marking; snap-on type; violet

www.wago.com/248-504/000-024



Item no.: 248-505/000-024
Mini-WSB marking card; as card; MARKED; 31 ... 40 (10x); not stretchable; Horizontal marking; snap-on type; violet

www.wago.com/248-505/000-024



Item no.: 248-506
Mini-WSB marking card; as card; MARKED; 41 ... 50 (10x); not stretchable; Horizontal marking; snap-on type; white

www.wago.com/248-506



Item no.: 793-501
WMB marking card; as card; not stretchable; plain; snap-on type; white

www.wago.com/793-501

Subject to changes.



Item no.: 793-501/000-002
WMB marking card; as card; not stretchable; plain; snap-on type; yellow

www.wago.com/793-501/000-002



Item no.: 793-501/000-005
WMB marking card; as card; not stretchable; plain; snap-on type; red

www.wago.com/793-501/000-005



Item no.: 793-501/000-006
WMB marking card; as card; not stretchable; plain; snap-on type; blue

www.wago.com/793-501/000-006



Item no.: 793-501/000-007
WMB marking card; as card; not stretchable; plain; snap-on type; gray

www.wago.com/793-501/000-007



Item no.: 793-501/000-012
WMB marking card; as card; not stretchable; plain; snap-on type; orange

www.wago.com/793-501/000-012



Item no.: 793-501/000-017
WMB marking card; as card; not stretchable; plain; snap-on type; light green

www.wago.com/793-501/000-017



Item no.: 793-501/000-023
WMB marking card; as card; not stretchable; plain; snap-on type; green

www.wago.com/793-501/000-023



Item no.: 793-501/000-024
WMB marking card; as card; not stretchable; plain; snap-on type; violet

www.wago.com/793-501/000-024



Item no.: 793-5501
WMB marking card; as card; for terminal block width 5 - 17.5 mm; stretchable 5 - 5.2 mm; plain; snap-on type; white

www.wago.com/793-5501



Item no.: 793-5501/000-002
WMB marking card; as card; for terminal block width 5 - 17.5 mm; stretchable 5 - 5.2 mm; plain; snap-on type; yellow

www.wago.com/793-5501/000-002



Item no.: 793-5501/000-005
WMB marking card; as card; stretchable 5 - 5.2 mm; plain; snap-on type; red

www.wago.com/793-5501/000-005



Item no.: 793-5501/000-006
WMB marking card; as card; stretchable 5 - 5.2 mm; plain; snap-on type; blue

www.wago.com/793-5501/000-006



Item no.: 793-5501/000-007
WMB marking card; as card; stretchable 5 - 5.2 mm; plain; snap-on type; gray

www.wago.com/793-5501/000-007

Subject to changes.



Item no.: 793-5501/000-012

WMB marking card; as card; stretchable 5 - 5.2 mm; plain; snap-on type; orange

www.wago.com/793-5501/000-012



Item no.: 793-5501/000-017

WMB marking card; as card; stretchable 5 - 5.2 mm; plain; snap-on type; light green

www.wago.com/793-5501/000-017



Item no.: 793-5501/000-023

WMB marking card; as card; stretchable 5 - 5.2 mm; plain; snap-on type; green

www.wago.com/793-5501/000-023



Item no.: 793-5501/000-024

WMB marking card; as card; stretchable 5 - 5.2 mm; plain; snap-on type; violet

www.wago.com/793-5501/000-024

Downloads

Documentation

Bid Text

859-304 X81 - Datei	Feb 19, 2019	xml 4.6 kB	Download
------------------------	--------------	---------------	----------

859-304 docx - Datei	Feb 20, 2019	docx 17.2 kB	Download
-------------------------	--------------	-----------------	----------

Instruction Leaflet

Relay modules, Optocoupler modules	V 1.2.0 Aug 30, 2019	pdf 2.2 MB	Download
------------------------------------	-------------------------	---------------	----------

Additional Information

Disposal; Electrical and electronic equipment, Packaging	V 1.0.0	pdf 265.8 kB	Download
--	---------	-----------------	----------

CAD/CAE-Data

CAD data

2D/3D Models 859-304	URL	Download
----------------------	-----	----------

CAE data

EPLAN Data Portal 859-304	Download
---------------------------	----------

Subject to changes.

Installation Notes

Inserting a conductor

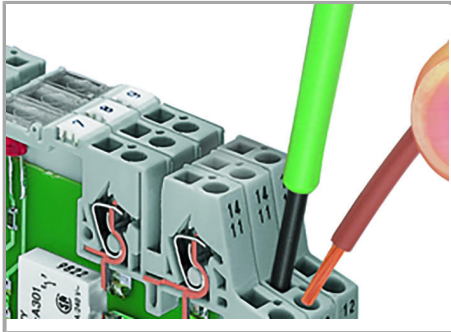

Connection of conductor

Jumpered

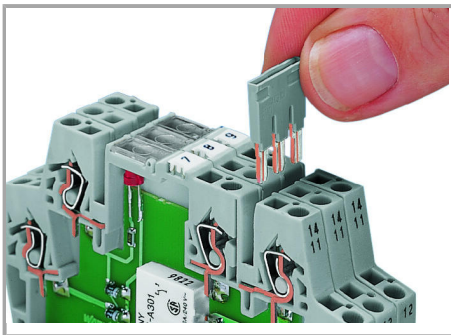

Easy commoning using adjacent jumpers

Marking

Subject to changes.



Marking using miniature WSB quick marking card

Subject to changes.