

Data sheet | Item number: 733-105

1-conductor female plug; 100% protected against mismatching; 0.5 mm²; Pin spacing 2.5 mm; 5-pole; 0,50 mm²; light gray

www.wago.com/733-105

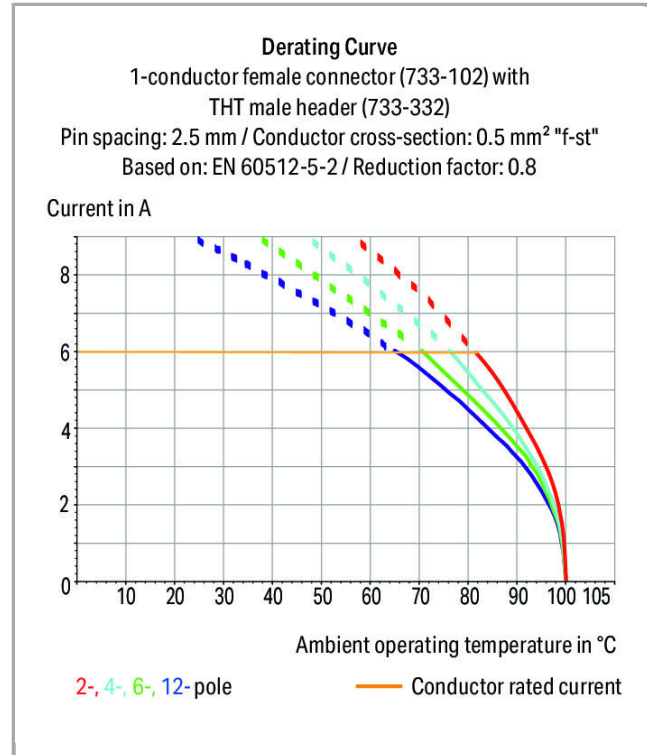

Subject to changes.

WAGO Kontakttechnik GmbH & Co. KG
Hansastr. 27
32423 Minden
Phone: +49571 887-0 | Fax: +49571 887-169
Email: info.de@wago.com | Web: www.wago.com

Do you have any questions about our products?
We are always happy to take your call at +49 (571) 887-44222.

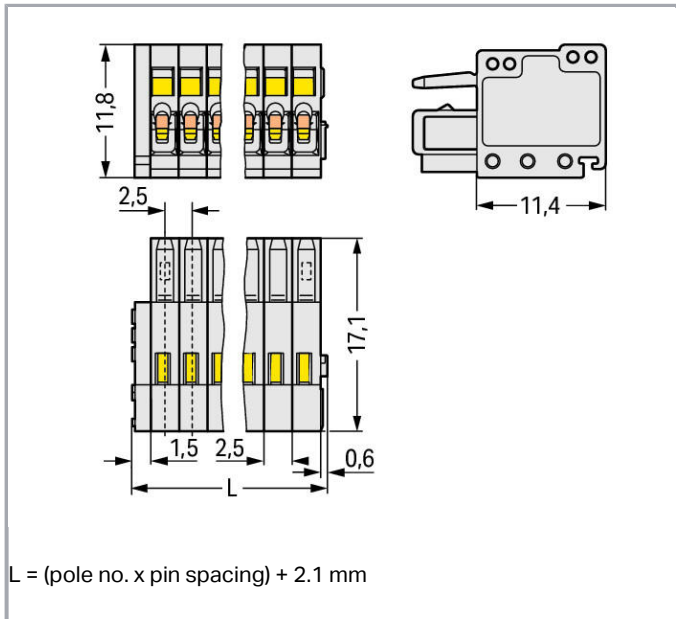

Item description

- Universal connection for all conductor types
- Easy cable pre-assembly and on-unit wiring via vertical and horizontal CAGE CLAMP® actuation
- Strain relief plates for factory and in-the-field assembly
- 100% protected against mismatching
- Coding via coding fingers

Safety information 1:

The *MULTI CONNECTION SYSTEM (MCS)* is designed without breaking capacity for compliance with DIN EN 61984. When used as intended, MCS Connectors shall not be connected/disconnected when live or under load. The circuit design should ensure header pins, which can be touched, are not live when unmated.

Data

Electrical data

Ratings per IEC/EN 60664-1

Rated voltage (III / 3)	100 V
Rated impulse voltage (III / 3)	2.5 kV
Rated voltage (III / 2)	160 V
Rated impulse voltage (III / 2)	2.5 kV
Rated voltage (II / 2)	320 V
Rated impulse voltage (II / 2)	2.5 kV

Subject to changes.

WAGO Kontakttechnik GmbH & Co. KG
 Hansastr. 27
 32423 Minden
 Phone: +49571 887-0 | Fax: +49571 887-169
 Email: info.de@wago.com | Web: www.wago.com

Do you have any questions about our products?
 We are always happy to take your call at +49 (571) 887-44222.



Rated current	6 A
Legend (ratings)	(III / 2) $\hat{=}$ Overvoltage category III / Pollution degree 2

Approvals per UL 1059

Rated voltage UL (Use Group B)	150 V
Rated current UL (Use Group B)	4 A

Approvals per CSA

Rated voltage CSA (Use Group B)	150 V
Rated current CSA (Use Group B)	4 A

Connection data

Connection technology	CAGE CLAMP [®]
Actuation type	Operating tool
Solid conductor	0.08 ... 0.5 mm ² / 28 ... 20 AWG
Fine-stranded conductor	0.08 ... 0.5 mm ² / 28 ... 20 AWG
Fine-stranded conductor with ferrule with plastic collar	0.25 ... 0.34 mm ²
Fine-stranded conductor with ferrule without plastic collar	0.25 ... 0.34 mm ²
Strip length	5 ... 6 mm / 0.2 ... 0.24 inch
No. of poles	5
Total number of connection points	5
Total number of potentials	5
Number of connection types	1
Number of levels	1
Conductor entry direction to mating direction	0°

Geometrical Data

Pin spacing	2.5 mm / 0.098 inch
Width	14.6 mm / 0.574 inch
Height	11.8 mm / 0.465 inch
Depth	17.1 mm / 0.673 inch

Plug connection

Contact type (pluggable connector)	Female connector/socket
Connector connection type	for conductors
Mismating protection	Yes

Subject to changes.

Material Data

Color	light gray
Material group	I
Insulating material	Polyamide 66 (PA 66)
Flammability class per UL94	V0
Clamping spring material	Chrome nickel spring steel (CrNi)
Contact material	Copper alloy
Contact plating	tin-plated
Fire load	0.041 MJ
Weight	2.2 g

Environmental Requirements



Limit temperature range	-60 ... +100 °C
-------------------------	-----------------

Commercial data

Product Group	3 (Multi Conn. System)
Packaging type	BOX
Country of origin	DE
GTIN	4044918294034
Customs Tariff No.	85366990990

Approvals / Certificates



Country specific Approvals

Logo	Approval	Additional Approval Text	Certificate name
	CCA DEKRA Certification B.V.	EN 61984	2169534.01
	CCA DEKRA Certification B.V.	IEC 61984	NL-31141
	CSA DEKRA Certification B.V.	C22.2	1465035



Ship Approvals

Certificate

Subject to changes.

Logo	Approval	Additional Approval Text	name
	ABS American Bureau of Shipping	-	19- HG1869876- PDA
	DNV GL Det Norske Veritas, Germanischer Lloyd	-	TAE000016Z
	LR Lloyds Register	IEC 61984	96/20035 (E5)

UL-Approvals



Logo	Approval	Additional Approval Text	Certificate name
	UL UL International Germany GmbH	UL 1977	E45171
	UR Underwriters Laboratories Inc.	UL 1059	20190122- E45172

Compatible products









Strain relief plate

	Item no.: 734-128 Strain relief plate; 12.5 mm wide; light gray	www.wago.com/734-128
--	---	--

ferrule

	Item no.: 216-131 Ferrule; Sleeve for 0.25 mm ² / AWG 24; uninsulated; electro-tin plated	www.wago.com/216-131
	Item no.: 216-132 Ferrule; Sleeve for 0.34 mm ² / AWG 24; uninsulated; electro-tin plated	www.wago.com/216-132

Subject to changes.

	Item no.: 216-151 Ferrule; Sleeve for 0.25 mm ² / AWG 24; uninsulated; electro-tin plated	www.wago.com/216-151
	Item no.: 216-152 Ferrule; Sleeve for 0.34 mm ² / AWG 24; uninsulated; electro-tin plated	www.wago.com/216-152
	Item no.: 216-301 Ferrule; Sleeve for 0.25 mm ² / AWG 24; insulated; electro-tin plated; yellow	www.wago.com/216-301
	Item no.: 216-302 Ferrule; Sleeve for 0.34 mm ² / 22 AWG; insulated; electro-tin plated; green	www.wago.com/216-302
	Item no.: 216-321 Ferrule; Sleeve for 0.25 mm ² / AWG 24; insulated; electro-tin plated; yellow	www.wago.com/216-321
	Item no.: 216-322 Ferrule; Sleeve for 0.34 mm ² / 22 AWG; insulated; electro-tin plated; green	www.wago.com/216-322
Marking accessories		
	Item no.: 210-331/250-202 Marking strips; as a DIN A4 sheet; MARKED; 1-16 (400x); Height of marker strip: 2.3 mm/0.091 in; Strip length 182 mm; Horizontal marking; Self-adhesive; white	www.wago.com/210-331/250-202
	Item no.: 210-331/250-204 Marking strips; as a DIN A4 sheet; MARKED; 17-32 (400x); Height of marker strip: 2.3 mm/0.091 in; Strip length 182 mm; Horizontal marking; Self-adhesive; white	www.wago.com/210-331/250-204
	Item no.: 210-331/250-206 Marking strips; as a DIN A4 sheet; MARKED; 33-48 (400x); Height of marker strip: 2.3 mm/0.091 in; Strip length 182 mm; Horizontal marking; Self-adhesive; white	www.wago.com/210-331/250-206
	Item no.: 210-331/250-207 Marking strips; as a DIN A4 sheet; MARKED; 1-48 (100x); Height of marker strip: 2.3 mm/0.091 in; Strip length 182 mm; Horizontal marking; Self-adhesive; white	www.wago.com/210-331/250-207
check		
	Item no.: 735-500 Test pin; 1 mm Ø; with solder connection for test wire	www.wago.com/735-500
tools		
	Item no.: 210-251 Operating tool; for MCS MICRO & MINI with CAGE CLAMP® connection; yellow	www.wago.com/210-251
	Item no.: 210-719 Operating tool; Blade: 2.5 x 0.4 mm; with a partially insulated shaft	www.wago.com/210-719
	Item no.: 233-331 Operating tool; insulated; yellow	www.wago.com/233-331
	Item no.: 233-332 Operating tool; made of insulating material	www.wago.com/233-332

Subject to changes.



Item no.: 233-335
Operating tool

www.wago.com/233-335



Item no.: 733-130
Operating tool; loose; natural

www.wago.com/733-130



Item no.: 733-191
Operating tool; loose; yellow

www.wago.com/733-191

Downloads

Documentation

Additional Information

Technical explanations	Apr 3, 2019	pdf 3.6 MB	Download
------------------------	-------------	---------------	----------

CAD/CAE-Data

CAD data

2D/3D Models 733-105	URL	Download
----------------------	-----	----------

CAE data

EPLAN Data Portal 733-105	Download
---------------------------	----------

Installation Notes

Protected Against Mismatching

Subject to changes.

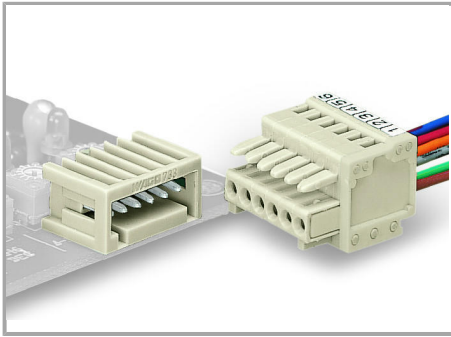

Male headers and female connectors are 100 % protected against mismatching.

Only mating halves with the same pole number can be connected.

Inserting a conductor

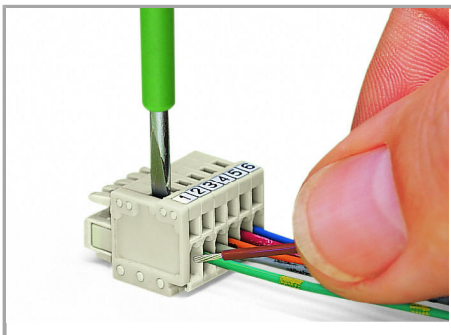

Inserting a conductor via (2.5 x 0.4) mm screwdriver. Operation is performed perpendicular to conductor entry.

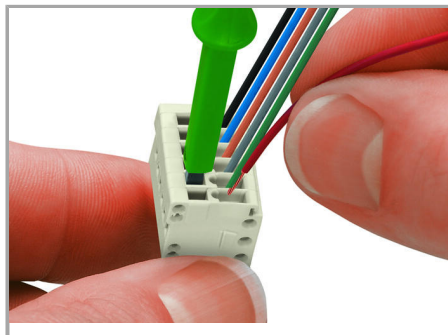

Inserting a conductor via screwdriver (233-335) – CAGE CLAMP® actuation parallel to conductor entry.

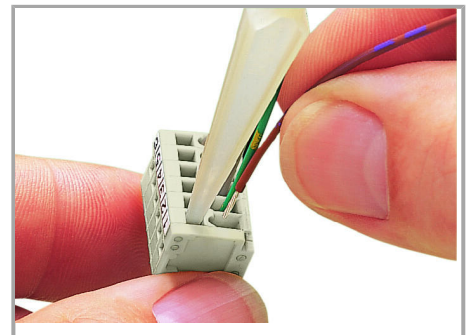

Subject to changes.

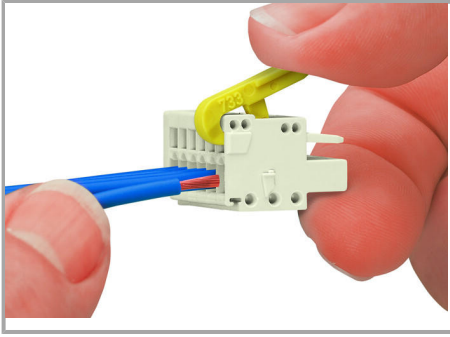

Inserting a conductor via 733-191 Operating Lever.

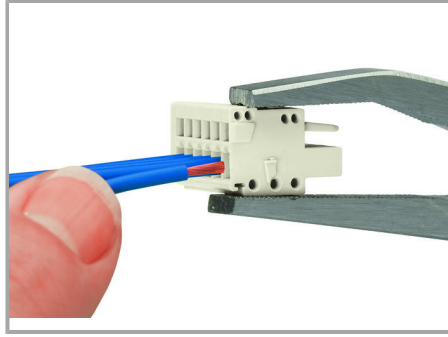

Inserting a conductor via 210-251 Operating Tool.

Coding

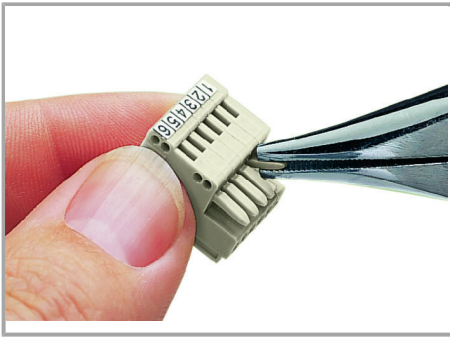

Coding a female connector – removing coding finger(s).

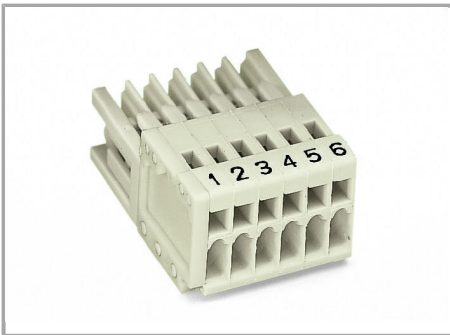

Assembly

Subject to changes.

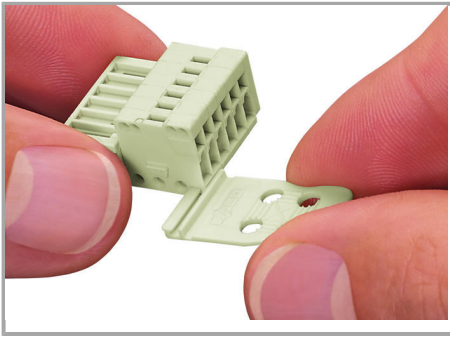

Strain relief plates for factory or in-the-field assembly.

Testing

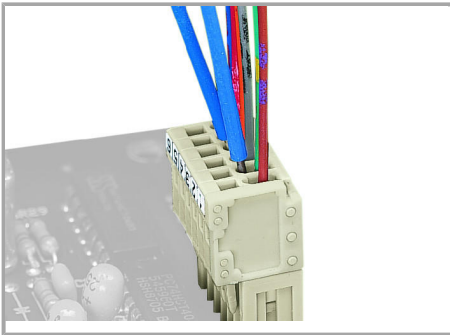

Testing via 1 mm Ø test pin (735-500) – touch contact.

Product family

MCS MICRO

[Show all products from the family](#)

Subject to changes.