

Electrical Installation Products

Series 773, 873, 222, 224, 243 and 862

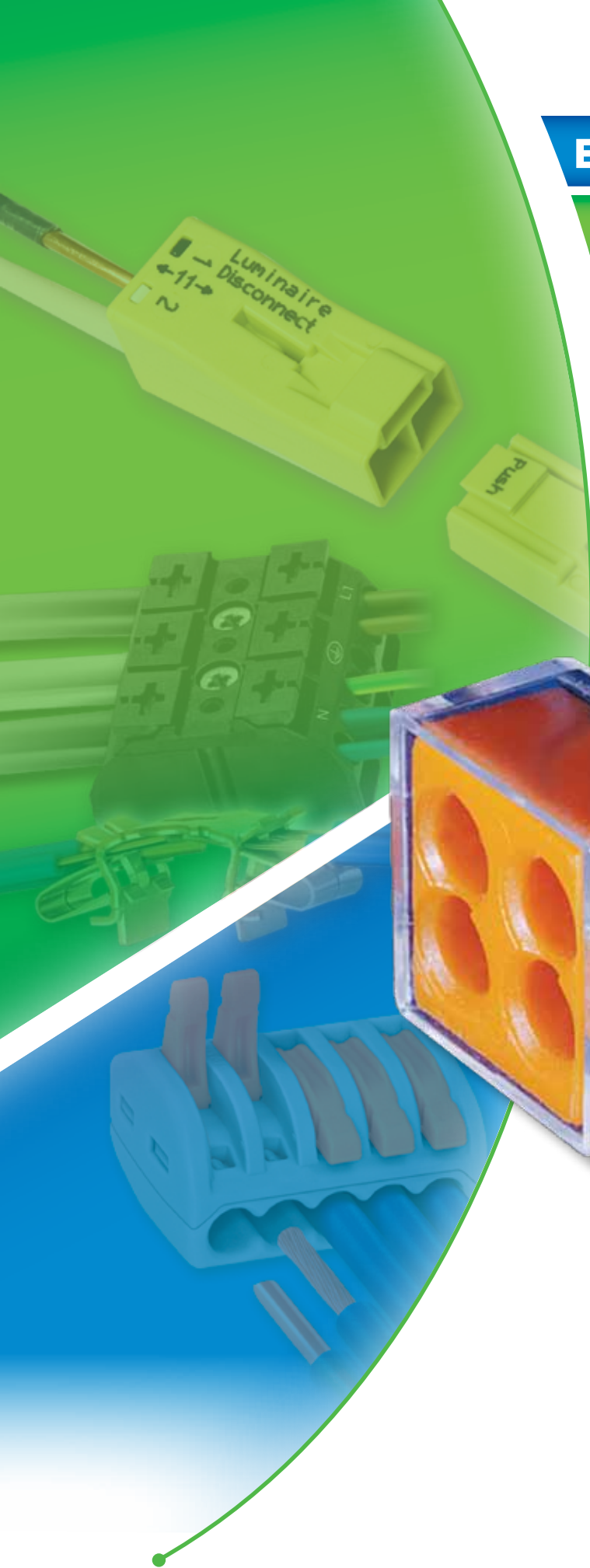

WAGO[®]
INNOVATIVE CONNECTIONS

PUSHWIRE® Connectors for Junction Boxes, (solid and stranded wire), 773 Series WALL-NUTS®



Simply strip conductor to 12 mm/0.47 in. using the built-in strip-length gauge



Then insert stripped conductor firmly into connector. Check for complete insertion through clear/transparent housing.



Wire Removal
Solid - Pull & Twist; Remove wire
Stranded - Cut Wire; Discard connector
Restrip conductor and insert into new connector

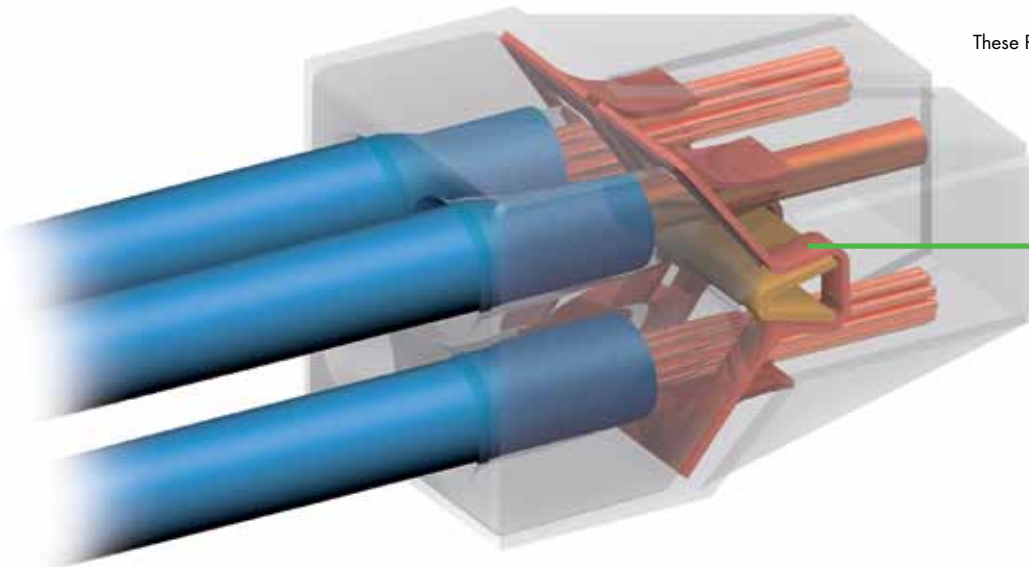

These PUSHWIRE® connectors clamp the following copper conductors:



solid



stranded



Integrated test port allows for easy testing of connection integrity

- Common (splice) up to 8 solid or stranded conductors in the same connector
- Option: mount to chassis or DIN rail via separate carrier
- The PUSHWIRE® connection clamps stranded or solid copper conductors
- Cross section up to 10 AWG
- Save up to 50% in wiring time over twist-type connectors

PUSHWIRE® Connectors for Junction Boxes, (solid and stranded wire), 773 Series WALL-NUTS®

<p>2 x 0.75 – 2.5 mm² "s" 2 x 1.5 – 2.5 mm² "r" 400 V/ 4 kV/2* 24 A Max. op. temp. 105 °C</p> <p>12 mm / 0.47 in</p> <p>UL LISTED Splicing wire connector 667 F</p> <p>SF</p>	<p>2 x AWG 18 – 12 "sol." 2 x AWG 16 – 12 "str." (≤19) 600 V 1000 V signs & fixtures</p>	<p>4 x 0.75 – 2.5 mm² "s" 4 x 1.5 – 2.5 mm² "r" 400 V/ 4 kV/2* 24 A Max. op. temp. 105 °C</p> <p>12 mm / 0.47 in</p> <p>UL LISTED Splicing wire connector 667 F</p> <p>SF</p>	<p>4 x AWG 18 – 12 "sol." 4 x AWG 16 – 12 "str." (≤19) 600 V 1000 V signs & fixtures</p>	<p>6 x 0.75 – 2.5 mm² "s" 6 x 1.5 – 2.5 mm² "r" 400 V/ 4 kV/2* 24 A Max. op. temp. 105 °C</p> <p>12 mm / 0.47 in</p> <p>UL LISTED Splicing wire connector 667 F</p> <p>SF</p>	<p>6 x AWG 18 – 12 "sol." 6 x AWG 16 – 12 "str." (≤19) 600 V 1000 V signs & fixtures</p>
-----------------------------------------------------------------------------------------------------------------------------------------------------------------------------------------------------------------------------	----------------------------------------------------------------------------------------------------------	-----------------------------------------------------------------------------------------------------------------------------------------------------------------------------------------------------------------------------	----------------------------------------------------------------------------------------------------------	-----------------------------------------------------------------------------------------------------------------------------------------------------------------------------------------------------------------------------	----------------------------------------------------------------------------------------------------------

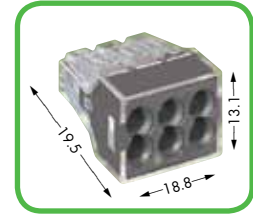
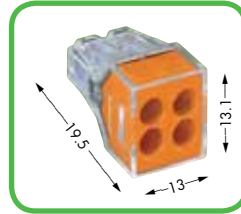
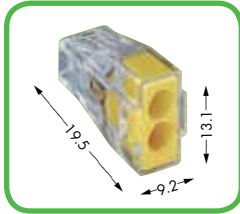

Item No.	Pack.-unit pcs	Item No.	Pack.-unit pcs	Item No.	Pack.-unit pcs
Pushwire connectors for junction boxes, 2-conductor connectors, color of housing transparent, color of cover yellow		Pushwire connectors for junction boxes, 4-conductor connectors, color of housing transparent, color of cover orange		Pushwire connectors for junction boxes, 6-conductor connectors, color of housing transparent, color of cover black	
773-162	100 pc/box	773-164	100 pc/box	773-166	50 pc/box
773-102/VE00-0500	500 pc/bag	773-104/PW05-400	400 pc/jar	773-106/PW00-250	250 pc/jar
773-102/PW05-650	650 pc/jar	773-104/VE00-0500	500 pc/bag	773-166/VE00-0500	500 pc/bag
773-102/VE00-2500	2500 pc/bag	773-104/VE00-2500	2500 pc/bag	773-166/VE00-2500	2500 pc/bag
51011251	10 pc/blister pack	5101252	10 pc/blister pack	51011253	10 pc/blister pack

<p>8 x 0.75 – 2.5 mm² "s" 8 x 1.5 – 2.5 mm² "r" 400 V/ 4 kV/2* 24 A Max. op. temp. 105 °C</p> <p>12 mm / 0.47 in</p> <p>UL LISTED Splicing wire connector 667 F</p> <p>SF</p>	<p>8 x AWG 18 – 12 "sol." 8 x AWG 16 – 12 "str." (≤19) 600 V 1000 V signs & fixtures</p>	<p>3 x 0.75 – 2.5 mm² "s" 3 x 1.5 – 2.5 mm² "r" 1 x 0.75 "sol.+rig." 400 V/ 4 kV/2* 24 A Max. op. temp. 105 °C</p> <p>12 mm / 0.47 in</p> <p>UL LISTED Splicing wire connector 667 F</p> <p>SF</p>	<p>3 x AWG 18 – 12 "sol." 3 x AWG 16 – 12 "str." (≤19) 1 x AWG 18 "sol.+str." (≤19) 600 V 1000 V signs & fixtures</p>	<p>3 x 1.5 – 6 mm² "s + st" 400 V/ 4 kV/2* 32 A Max. op. temp. 105 °C</p> <p>12 mm / 0.47 in</p> <p>UL LISTED Splicing wire connector 667 F</p> <p>SF</p>	<p>3 x AWG 14 – 10 "sol." + "str." (≤19) 600 V 1000 V signs & fixtures</p>
-----------------------------------------------------------------------------------------------------------------------------------------------------------------------------------------------------------------------------	----------------------------------------------------------------------------------------------------------	------------------------------------------------------------------------------------------------------------------------------------------------------------------------------------------------------------------------------------------------------	-------------------------------------------------------------------------------------------------------------------------------------------	------------------------------------------------------------------------------------------------------------------------------------------------------------------------------------------	--------------------------------------------------------------------------------------------

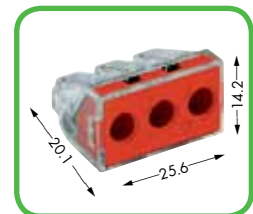
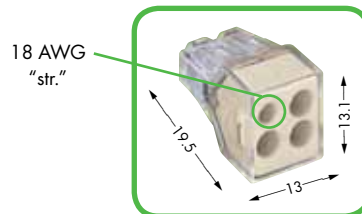
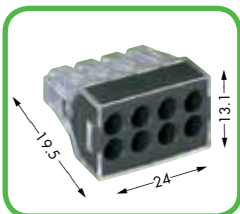

Item No.	Pack.-unit pcs	Item No.	Pack.-unit pcs	Item No.	Pack.-unit pcs
Pushwire connectors for junction boxes, 8-conductor connectors, color of housing transparent, color of cover dark grey		Pushwire connectors for junction boxes, 4-conductor connectors, filled with contact paste "Alu-Plus", color of housing transparent, color of cover light grey		Pushwire connectors for junction boxes, 3-conductor connectors, color of housing transparent, color of cover red	
773-168	50 pc/box	773-124	100 pc/box	773-173	50 pc/box
773-108/VE00-2500	2500 pc/bag	773-124/VE01-0000	2500 pc/bag	773-173/PW05-200	200 pc/jar
51013414	10 pc/blister pack			773-173/VE00-0500	500 pc/bag
				773-173/VE00-2500	2500 pc/bag
				51015201	5 pc/blister pack

Packaging Options



Box









Blister Pack



Jar

PUSHWIRE® Connectors for Junction Boxes, (solid and stranded wire), 773 Series WALL-NUTS® for Grounding and Bonding





2 x 0.75–2.5 mm ² "s" 2 x 1.5–2.5 mm ² "r" 400 V/4 kV/2* 24 A Max. op. temp. 105°C	2 x AWG 18-12 "sol." 2 x AWG 16-12 "str." (≤19) 600 V 1000 V signs & fixtures	4 x 0.75 – 2.5 mm ² "s" 4 x 1.5 – 2.5 mm ² "r" 400 V/4 kV/2* 24 A Max. op. temp. 105°C	4 x AWG 18 – 12 "sol." 4 x AWG 16–12 "str." (≤19) 600 V 1000 V signs & fixtures	6 x 0.75 – 2.5 mm ² "s" 6 x 1.5 – 2.5 mm ² "r" 400 V/4 kV/2* 24 A Max. op. temp. 105°C	6 x AWG 18 – 12 "sol." 6 x AWG 16 – 12 "str." (≤19) 600 V 1000 V signs & fixtures
 12 mm / 0.47 in  	 12 mm / 0.47 in  	 12 mm / 0.47 in  			

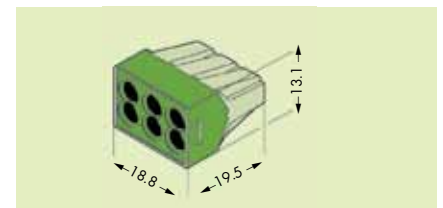
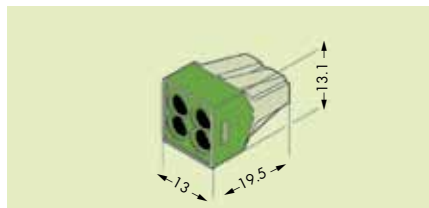
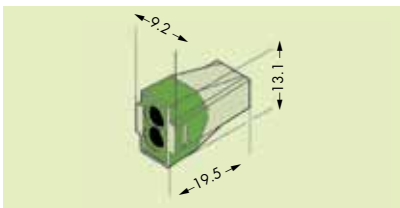

Item No.	Pack.-unit pcs	Item No.	Pack.-unit pcs	Item No.	Pack.-unit pcs
Pushwire connectors for junction boxes, 2-conductor connectors, color of housing transparent, color of cover green		Pushwire connectors for junction boxes, 4-conductor connectors, color of housing transparent, color of cover green		Pushwire connectors for junction boxes, 6-conductor connectors, color of housing transparent, color of cover green	
773-112	100 pc/box	773-114	100 pc/box	773-116	50 pc/box

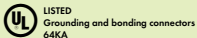

773 Series WALL-NUTS® for High Temp Applications

8 x 0.75 – 2.5 mm ² "s" 8 x 1.5 – 2.5 mm ² "r" 400 V/4 kV/2* 24 A Max. op. temp. 105°C	8 x AWG 18 – 12 "sol." 8 x AWG 16 – 12 "str." (≤19) 600 V 1000 V signs & fixtures	Carrier for Push-Wire Connectors Carrier width 18 mm / 0.7 in	4 x 0.75 – 2.5 mm ² "s" 4 x 1.5 – 2.5 mm ² "r" 400 V/4 kV/2* 24 A Max. op. temp. 150°C	4 x AWG 18 – 12 "sol." 4 x AWG 16 – 12 "str." (≤19) 4 x AWG 18 "str." tinned ≤ 7 600 V 1000 V signs & fixtures
 12 mm / 0.47 in  	 12 mm / 0.47 in  			

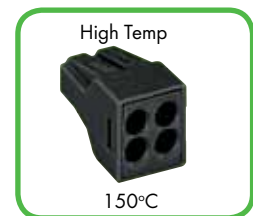
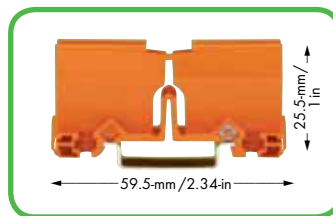

Item No.	Pack.-unit pcs	Item No.	Pack.-unit pcs	Item No.	Pack.-unit pcs
Pushwire connectors for junction boxes, 8-conductor connectors, color of housing transparent, color of cover green		Fixing carrier for 4 pushwire connectors orange		Pushwire connectors for high temperature applications, 4-conductor connectors, color of housing black, color of cover black	
773-118	50 pc/box	light grey	773-331 50 pc/box	773-514	50 pc/box
		Marker strip, plain	243-110 1 ea		

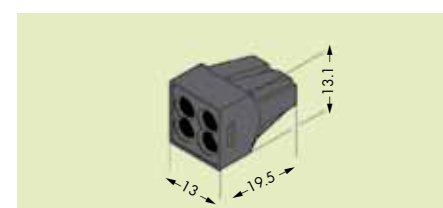
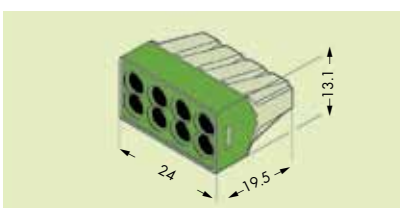

PUSHWIRE® Connectors for Junction Boxes, (solid and stranded wire), 773 Series WALL-NUTS® Suitable for EEx e Applications

Conductor Range:	AWG 18-12 (solid) AWG 16-12 (stranded ≤19) AWG 14-10 (3-conductor only)*	Color:	Light Gray (housing and cover)
Electrical specs:	600 V / 20 A maximum 600 V / 30 A maximum (3-conductor only)*	Strip length: 	12 mm / 0.47 in 15 mm / 0.53 in (3-conductor only)*

The WAGO 773 Series for applications in hazardous areas is an extension of the WAGO PUSHWIRE® connectors product group and has the same benefits in installation, technology, and reliable connection as the standard 773 Series for commercial and residential applications. The world's first PUSHWIRE® connectors offer the following features:

- Compact design allows a high concentration of more connectors in an Ex-junction box or Ex-terminal box resulting in space-savings and cost-effective installation solutions
- Easy wiring provides time-saving installation and saves money
- Resistance to vibration (shock-proof)
- Built-in test slot for easy troubleshooting
- Maintenance-free connection

Height: 13.1 mm / 0.516 in
Width: 9 mm / 0.354 in
Depth: 19.1 mm / 0.752 in





Height: 13.1 mm / 0.516 in
Width: 13 mm / 0.512 in
Depth: 19.1 mm / 0.752 in



Height: 13.1 mm / 0.516 in
Width: 19 mm / 0.748 in
Depth: 19.1 mm / 0.752 in



Item No.	Pack.-unit pcs	Item No.	Pack.-unit pcs	Item No.	Pack.-unit pcs
 773-492	100	 773-494	100	 773-496	100

Height: 13.1 mm / 0.516 in
Width: 24 mm / 0.945 in
Depth: 19.1 mm / 0.752 in





Height: 14.2 mm / 0.559 in
Width: 25.6 mm / 1.008 in
Depth: 20.1 mm / 0.791 in



Height: 30 mm / 1.181 in
Width: 18 mm / 0.709 in
Depth: 61 mm / 2.402 in



Item No.	Pack.-unit pcs	Item No.	Pack.-unit pcs	Item No.	Pack.-unit pcs
 773-498	100	 773-493	50	773-331	50 (5 x 10)



NOTE: For hazardous applications, this 773 Series MUST be used in conjunction with the mounting carrier specified on this page (item number 773-331).

Certification according to ATEX / UL Ex is based upon the use of the entire system (connector and fixing carrier).



Simple insertion of 773 into carrier - no tools required



End stops are locked in place to secure the connectors



Mounting carrier with connectors snaps on DIN RAIL



Removal of carrier from DIN RAIL

PUSHWIRE® Connector for Luminaire Disconnect, 873 Series LUMI-NUTS®



Molded in color coding for circuit wiring:
 Black = L
 White = N
 Red = dimming and switching (3-pole)
 Green = Ground (3-pole)
 Inkjet marking for additional requirements



Integrated locking latch - automatic locking with mating of connectors - simple push down to disengage

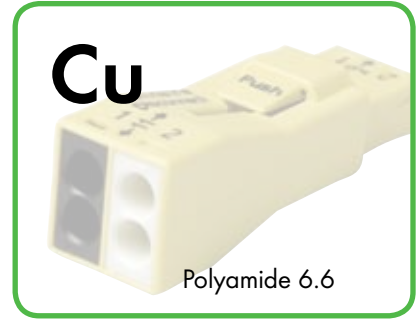

Copper (not brass) for electrical integrity. UL94V-0 rated housing for utmost in flame-retardation

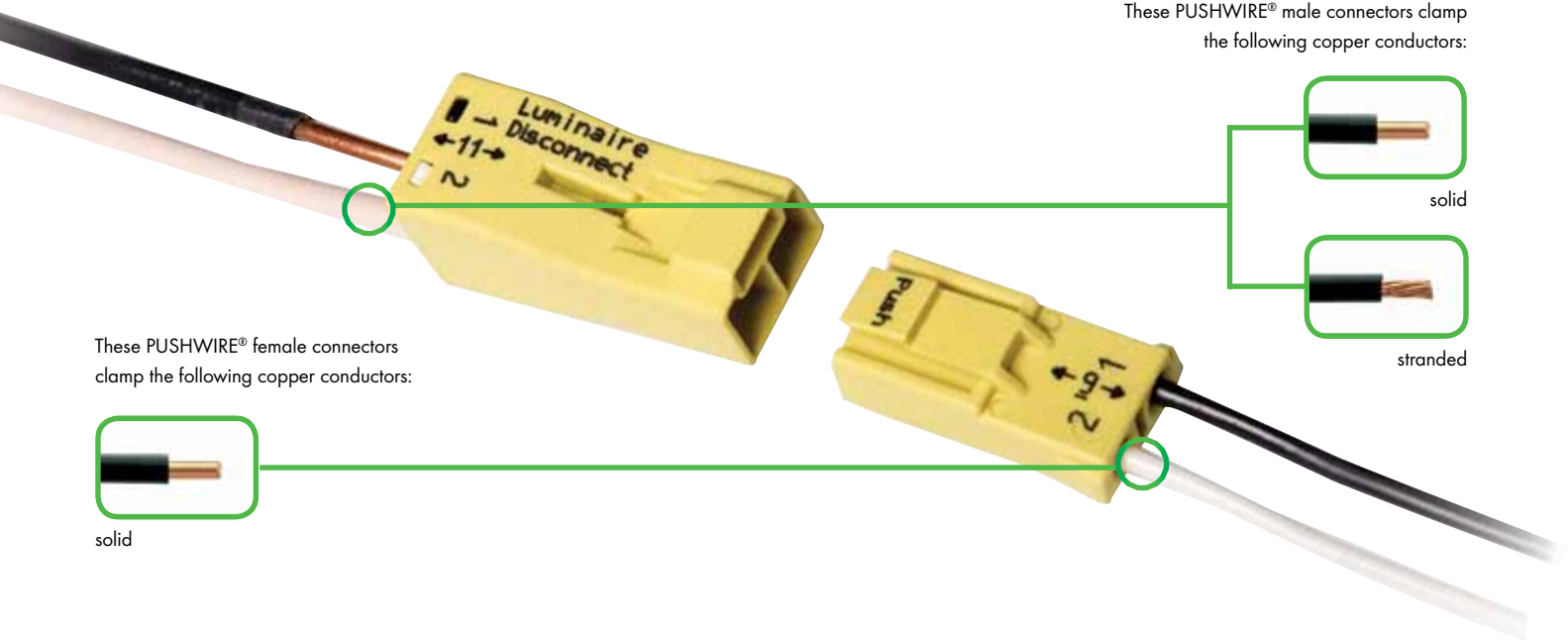

These PUSHWIRE® male connectors clamp the following copper conductors:

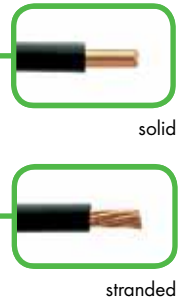

These PUSHWIRE® female connectors clamp the following copper conductors:



solid

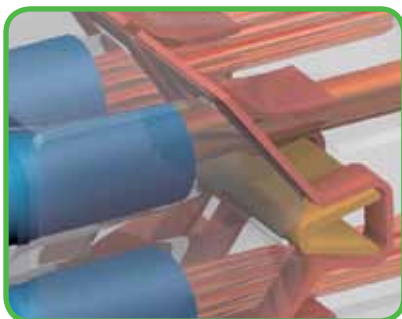

Engineered two-piece construction: Copper current bar and stainless steel spring combine to provide optimal contact pressure independent of the housing





Completely touch-proof in the unmated position



100% protected against mis-mating

PUSHWIRE® Connector for Luminaire Disconnect, 873 Series LUMI-NUTS®

Male Connector 2 x AWG 18-12 "sol." per pole 2 x AWG 16-12 ≤19 "str." per pole 600 V 20 A Current capacity at max conductor size  11-13 mm/0.47 in	Female Connector 1 x AWG 18 "sol." per pole 600 V 6 A 9-11 mm/0.39 in	Male Connector 2 x AWG 18-12 "sol." per pole 2 x AWG 16-12 ≤19 "str." per pole 600 V 20 A Current capacity at max conductor size  11-13 mm/0.47 in	Female Connector 1 x AWG 18 "sol." per pole 600 V 6 A 9-11 mm/0.39 in	Male Connector 2 x AWG 18-12 "sol." per pole 2 x AWG 16-12 ≤19 "str." per pole 600 V 20 A Current capacity at max conductor size  11-13 mm/0.47 in	Female Connector 1 x AWG 18 "sol." per pole 600 V 6 A 9-11 mm/0.39 in
--------------------------------------------------------------------------------------------------------------------------------------------------------------------------------------------------------------------------------------------------------------	------------------------------------------------------------------------------------------	--------------------------------------------------------------------------------------------------------------------------------------------------------------------------------------------------------------------------------------------------------------	------------------------------------------------------------------------------------------	----------------------------------------------------------------------------------------------------------------------------------------------------------------------------------------------------------------------------------------------------------------	------------------------------------------------------------------------------------------

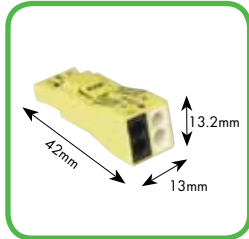

Fits through 1/2 in knockout

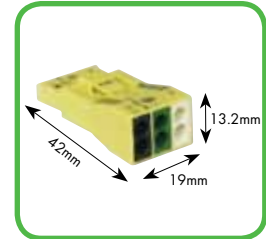
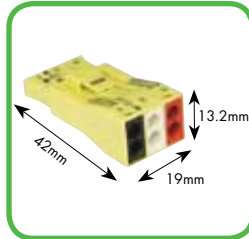

Item No.	Pack.-unit pcs	Item No.	Pack.-unit pcs	Item No.	Pack.-unit pcs
Pushwire connectors for luminaire disconnect, 2-pole connectors		Pushwire connectors for luminaire disconnect, 3-pole connectors, for switching and dimming applications		Pushwire connectors for luminaire disconnect, 3-pole connectors, with "make first/break last" ground circuit	
873-902		873-903		873-953	
873-902/K194-4045	25 pc/box	873-903/K194-4045	20 pc/box	873-953/VE00-0500	500 pc/bag
873-902/PW05-200	200 pc/jar	873-903/PW05-100	100 pc/jar		
873-902/VE00-0500	500 pc/bag	873-903/VE00-0500	500 pc/bag		
873-902/VE00-5000	5,000 pc/bag				

Packaging Options



Box



Jar

Optimal Installation

Exclusive dual port design *eliminates* the need for additional splicing connectors when wiring multiple luminaires, *minimizing component costs and labor.*

Daisy chain to...

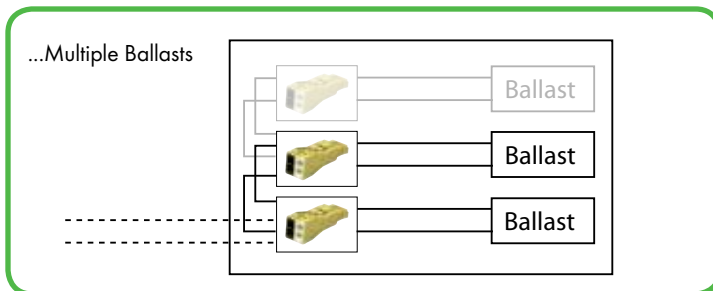
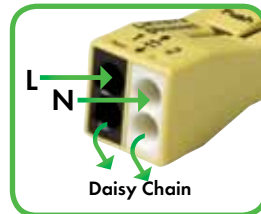

Field Wiring

Factory Wiring

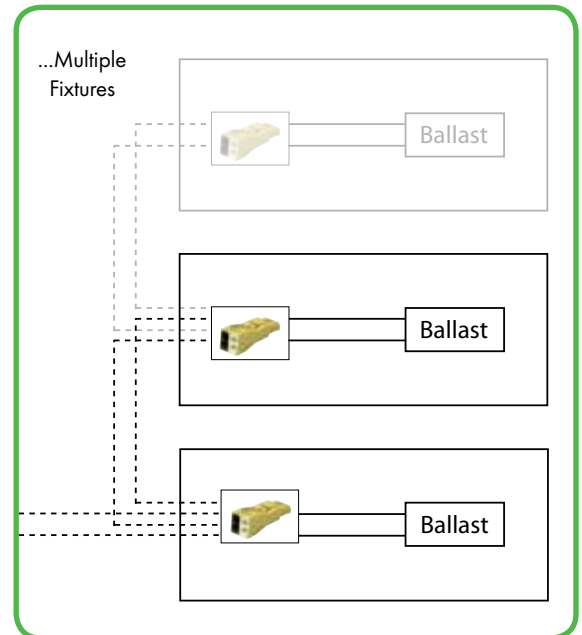

Additional Specifications

Meets: 2008 NEC 410.130(G) and CEC 30-308(4) for non-residential fluorescent luminaires
 UL2459 listed insulated multi-pole splicing connector (luminaire disconnect)
 CSA 22.2 No. 2459 certified insulated multi-pole splicing connector (luminaire disconnect)
 EN/IEC 60998 and EN/IEC61984 certified connector
 Max operating temperature: 105°C
 Flammability rating: UL94V-0



Listed

Luminaire Disconnect
3NLY

Compact Splicing Connectors, 222 Series LEVER-NUTS®



1) Strip Wire



2) Push up lever



3) Insert conductor and push down lever

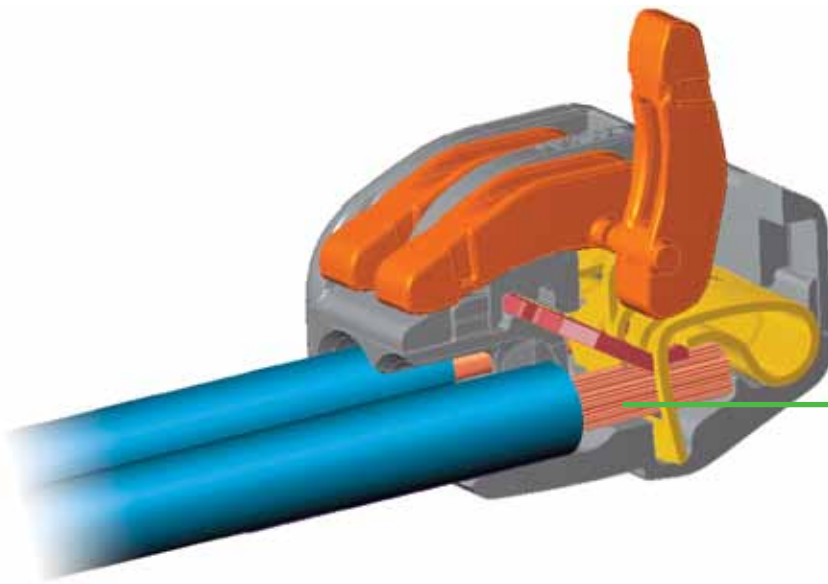

These CAGE CLAMP® connectors clamp the following copper conductors:



solid



stranded



fine stranded



fine stranded,
tip bonded



fine stranded with
crimp ferrule



find stranded with
crimped pin terminal





Wiring of flexible conductors
in a junction box



Integrated test port allows for easy testing of
connection integrity

Compact Splicing Connectors, 222 Series LEVER-NUTS®

Cross section:	28 – 12 AWG (solid, stranded and flexible)	
Electrical specs:	600 V (1000 V signs and fixtures) 20 A maximum * Based on 2008 NEC current rating of max conductor size	
Strip length: 	9 - 10 mm / 0.37 in	
Maximum operating temperature: 105° C		Approvals: UL, ENEC, PSE, ABS Also approved for grounding and bonding

For all connections requiring...

- Stranded / solid wires
- Wide range of wire sizes
- Combination of different wire sizes and types in one connector
- Small space consumption
- Built-in test point
- Protection against electrical shock, touch safe
- Low installed cost and safe operation
- Maintenance-free connection
- A reusable connector

2-conductor connector



3-conductor connector



5-conductor connector



Item No.	Pack.-unit pcs	Item No.	Pack.-unit pcs	Item No.	Pack.-unit pcs
222-412		222-413		222-415	
222-412/K194-4045	50 pc box (1=50)	222-413/K194-4045	50 pc box (1=50)	222-415/K194-4045	40 pc box (1=40)
222-412/PW05-0005	5 pc blister pack	222-413/PW05-0005	5 pc blister pack	222-415/PW05-0005	5 pc blister pack
222-412/PW05-350	350 pc jar	222-413/PW05-250	250 pc jar	222-415/PW05-150	150 pc jar
222-412/VE00-2500	2,500 pc bulk bag	222-413/VE00-2500	2,500 pc bulk bag	222-415/VE00-1000	1,000 pc bulk bag

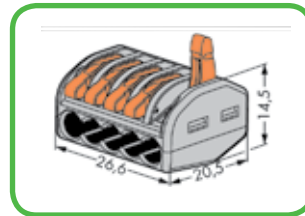
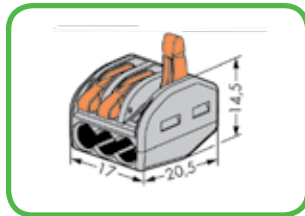
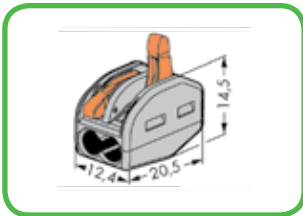

Accessories	Item No.	Pack.-unit pcs
Wire cutting and stripping tool (34-8 AWG)	206-124	1
Operating tool for Series 222	210-101	1

Packaging Options



Box



Blister Pack



Jar



Operating tool



Wire cutting and stripping tool

222 Series Mounting Carrier for LEVER-NUTS®

Mounting carrier for 222 Series compact connectors Accommodates: 2 x 222-415 1 x 222-415 + 1 x 222-413 3 x 222-413 1 x 222-415 + 2 x 222-412 4 x 222-412 3 x 222-412 + 1 x 222-413	Strain relief plate for 222-500 mounting carrier	Universal right angled adapter for 222-500 mounting carrier 773-332 mounting carrier 273-150 mounting carrier
---------------------------------------------------------------------------------------------------------------------------------------------------------------------------------------------------------------------------------	---------------------------------------------------------	----------------------------------------------------------------------------------------------------------------------------



Item No.	Pack.-unit pcs	Item No.	Pack.-unit pcs	Item No.	Pack.-unit pcs
Mounting carrier, orange, for 2-, 3- or 5-conductor compact connectors		Strain relief plate, orange, for snap-on fixing to 222-500 mounting carrier		Universal right angled adapter, gray, in combination with mounting carriers for DIN 35 rail mounting	
222-500	50 (5x10)	222-505	50 (5x10)	222-510	50 (5x10)
Self-adhesive marker strips, plain	210-334				
	1 card				

Assembly



Snapping of lateral connector safety lock



Mounting of strain relief plate to the mounting carrier



Snapping the universal right angled adapter on the mounting carrier

Mounting



Horizontal mounting with strain relief plate on DIN 35 rail using universal right angled adapter



Strain relief by cable tie on the carrier, transverse to the connectors wiring direction. Molded marking of clamping units.



Horizontal mounting with strain relief plate on level surfaces. Testing connectors via test slots in the carrier.

Lighting & "Service" Connectors, Series 224

Fixture Side

CAGE CLAMP®

Power Input Side

PUSH WIRE®

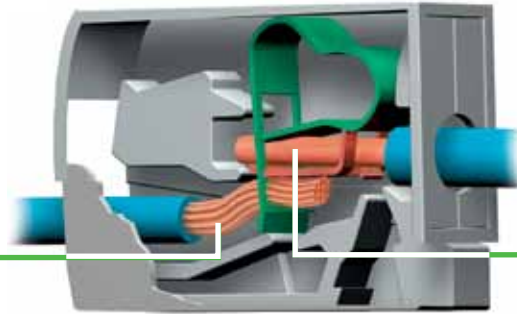

These PUSHWIRE® connectors clamp the following copper conductors:



solid



stranded



fine stranded



fine stranded,
tip bonded



fine stranded with
crimped ferrule



fine stranded with
crimped pin terminal



solid

Fixture Side

CAGE CLAMP®



Connection of conductors (lighting side):
Press button fully and insert stripped conductor into square entry and release



To remove: Press button and withdraw conductor

Power Input Side

PUSH WIRE®



Connection of conductors (installation side):
Introduce stripped solid conductor into circular entry and push to stop



Removal: Hold wire to be removed and twist alternating left and right while pulling the conductor

- The perfect in-line connector for solid-to-stranded wire
- Also with double service connection
- Tool-free connection



Testing through separate test slot

Lighting & "Service" Connectors, Series 224

Power input side
1.0 - 2.5 mm² "s"
Fixture side
0.5 - 2.5 mm² "s + f-st"
400 V/4 kV/2** ; 24 A
9 - 11 mm / 0.39 in
* VDE CCA N S D R GLBV

Power input side
2-x-1.0 - 2.5 mm² "s"
Fixture side
0.5 - 2.5 mm² "s + f-st"
400 V/4 kV/2** ; 24 A
9 - 11 mm / 0.39 in
* VDE CCA N S D R GLBV

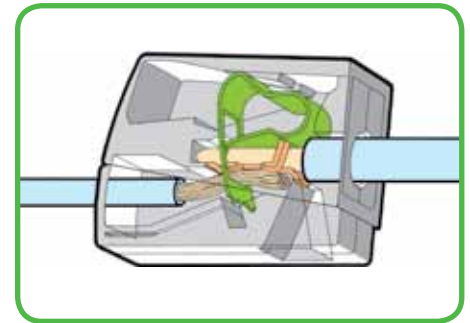

Cutaway of lighting connector

Item No.	Pack.-unit pcs	Item No.	Pack.-unit pcs
Lighting connectors, standard version, continuous service temperature 105°C, grey	224-101 1000 (10 x 100)	2-conductor lighting connectors, standard version, continuous service temperature 105°C, white	224-112 1000 (10 x 100)
version for increased continuous service temperature 120°C, black	224-104 100	version for increased continuous service temperature 120°C, black	224-114 100
"Service" connector, grey	224-201 50		

Stripped length

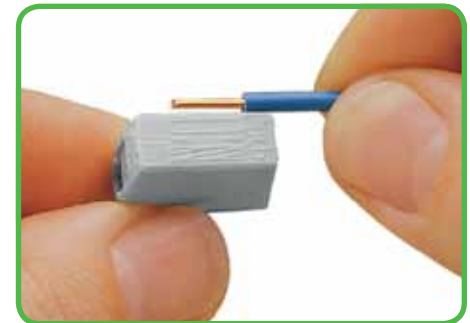

Strip conductor to 9 - 11 mm / 0.39 in

Dimensions (in mm)

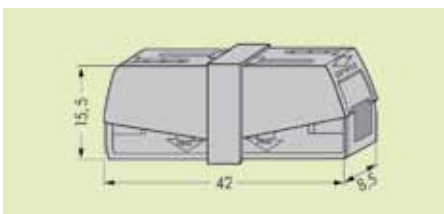
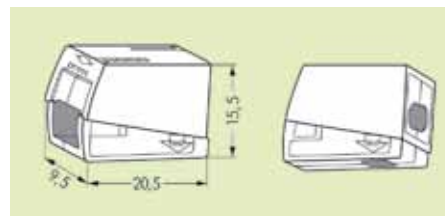
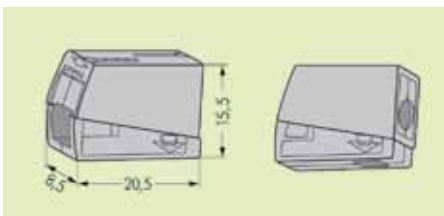

Testing



Testing through separate test slot

MICRO PUSHWIRE® Connectors for Junction Boxes, Fixing Carrier Series 243

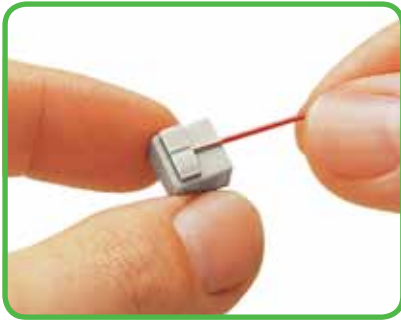

Stripped Length
Strip solid wire to 5-6 mm/.22 in

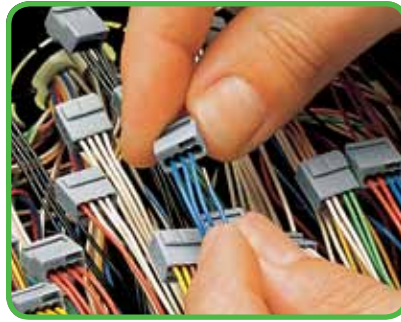

Connection
Insert stripped conductor FULLY



Removal
Hold wire to be removed and twist alternating left and right while pulling the conductor

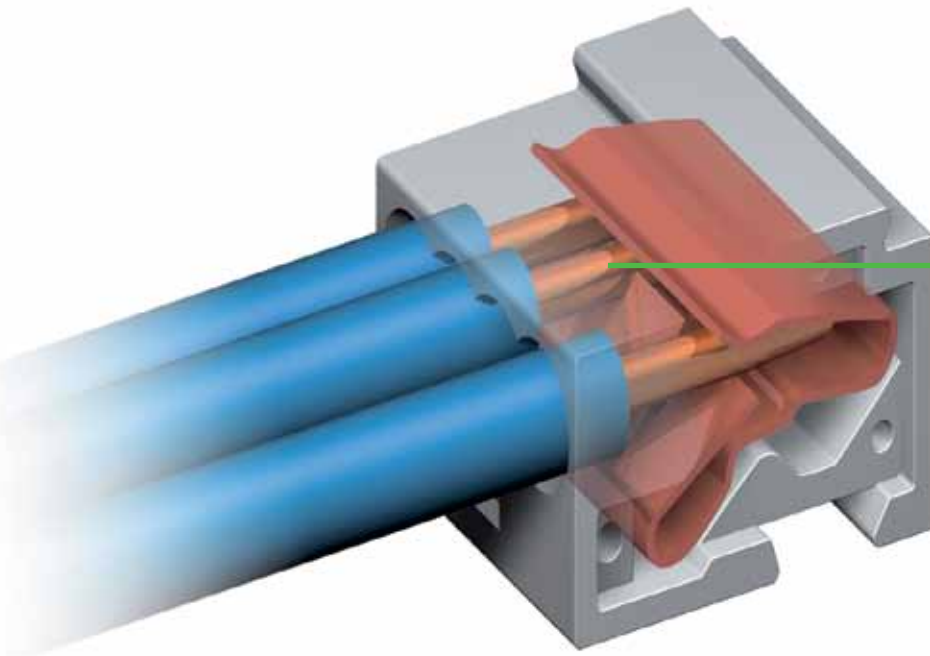

These PUSHWIRE® connectors clamp the following copper conductors:



solid





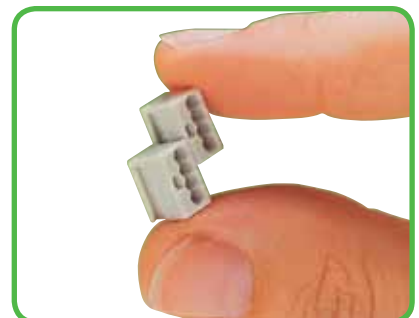









Testing



Connector Blocks
Assembly of modular connectors to connector strips

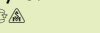

MICRO PUSHWIRE® Connectors for Junction Boxes, Fixing Carrier

Series 243

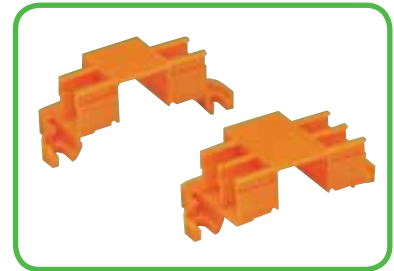
<p>4x0.6– 0.8 Ø mm "s"***</p> <p>100 V/ 1.5 kV/2</p> <p>6 A</p>	<p>4 x AWG 22 – 20 "sol."***</p> <p>125 V, 7 A </p> <p>150 V, 7 A </p>	<p>8x0.6– 0.8 Ø mm "s"***</p> <p>100 V/ 1.5 kV/2</p> <p>6 A</p>	<p>8 x AWG 22 – 20 "sol."***</p> <p>125 V, 7 A </p> <p>150 V, 7 A </p>	<p>Fixing carrier for MICRO push-wire connectors</p>
<p> 5 – 6 mm / 0.22 in</p> <p>*    </p>		<p> 5 – 6 mm / 0.22 in</p> <p>*    </p>		



Item No.	Pack.-unit pcs	Item No.	Pack.-unit pcs	Item No.	Pack.-unit pcs	
MICRO pushwire connectors for junction boxes, 4-conductor connectors		MICRO pushwire connectors for junction boxes, 8-conductor connectors		Fixing carrier		
dark grey	243-204	1000 (10 x 100)	dark grey	243-208	500 (10 x 50)	
red	243-804	1000 (10 x 100)	red	243-808	500 (10 x 50)	
light grey	243-304	1000 (10 x 100)	light grey	243-308	500 (10 x 50)	
yellow	243-504	1000 (10 x 100)	yellow	243-508	500 (10 x 50)	
				for 4 pushwire connectors	243-112	50 (5 x 10)
				for 6 pushwire connectors	243-113	50 (5 x 10)
				Marker strip, plain	243-110	1

<p>4x 0.4 – 0.5 Ø mm "s"</p> <p>100 V/ 1.5 kV/2</p> <p>6 A</p>	<p>4 x AWG 26 – 24 "sol."</p>
<p> 5 – 6 mm / 0.22 in</p> <p>*  </p>	



Item No.	Pack.-unit pcs
MICRO pushwire connector for junction boxes, 4-conductor connector	
transparent	243-144
	1000 (10 x 100)

Dimensions (in mm)

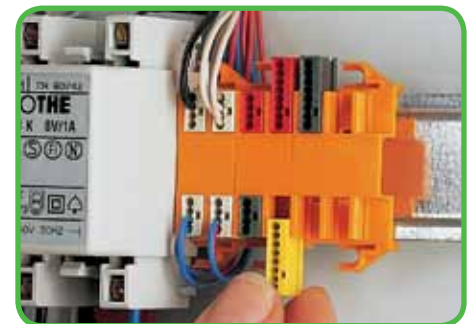
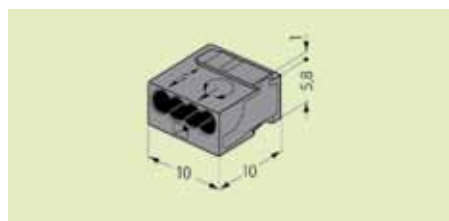

Inserting a MICRO PUSHWIRE® connector for junction boxes into the carrier

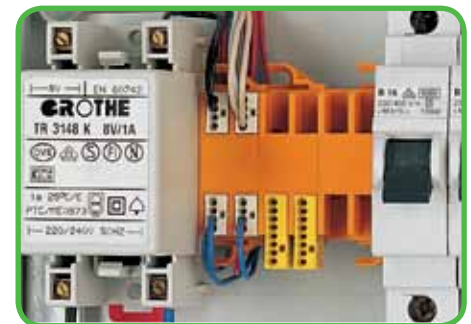

Example of doorbell application - mounted on DIN 35 rail

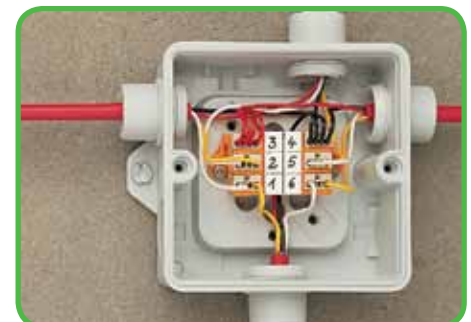

Typical application in a terminal box for burglar alarm - screw fixing

* You can find approvals on the Internet at www.wago.us

**When using wires of the same diameter only, 0.5 Ø mm/AWG 24 or 1.0 Ø mm/AWG 18 are also possible

Cost Effective Terminal Blocks for Chassis Mounting, Series 862

Conductor Connection



- Four conductors per pole
- For solid and stranded conductors
- Mixed wiring with solid and stranded conductors of different cross sections

Marking



- Available pre-printed with single phase, 2 phase or 3 phase markings. Optional marker strip allows for marking via permanent marker or thermal printer (TP-343).

Jumpering



- Commoning with jumper bar

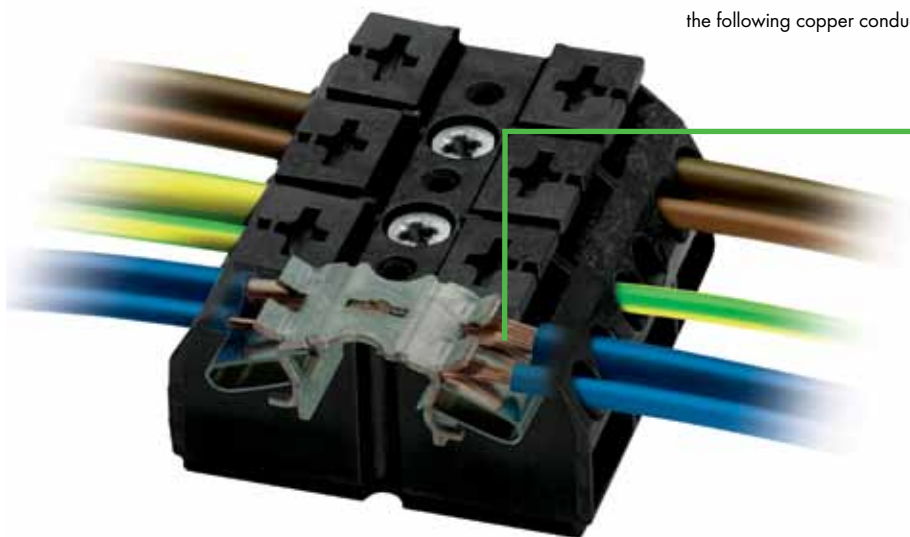

These CAGE CLAMP[®]S connectors clamp the following copper conductors:



solid



stranded



fine stranded



fine stranded,
tip bonded



fine stranded with
crimped ferrule



fine stranded with
crimped pin terminal

Cost-Effective Features:

The 862 Series chassis-mount terminal blocks minimize wiring costs and simplify mounting, while offering multiple connection points, marking and handling.

- Connects up to four conductors (sizes 22 - 12 AWG). Due to multiple connection points/pole, different sizes can be used within same terminal block position.
- CAGE CLAMP[®]S termination technology: solid conductors, stranded conductors with ferrules or ultrasonically bonded conductors are simply connected by pushing conductor into the contact.
- Integrated push button, with molded-in slots, accommodates fast and easy wiring of all conductor types – by hand or slotted tip/Phillips screwdriver.
- Convenient automatic grounding contact available.
- Snap-in mounting feet for fast assembly.
- Flexible marking options: standard marking (pre-marked), marker strip or custom marked for large quantity orders.
- Built-in test points simplify testing with 2mm/0.079 in. diameter test plug.

TP-343 printer for marking strip



Ground (earth) contact



- Makes an automatic contact to the mounting plate
- Varnish coating is penetrated automatically

Cost Effective Terminal Blocks for Chassis Mounting, Series 862, Fastening Options

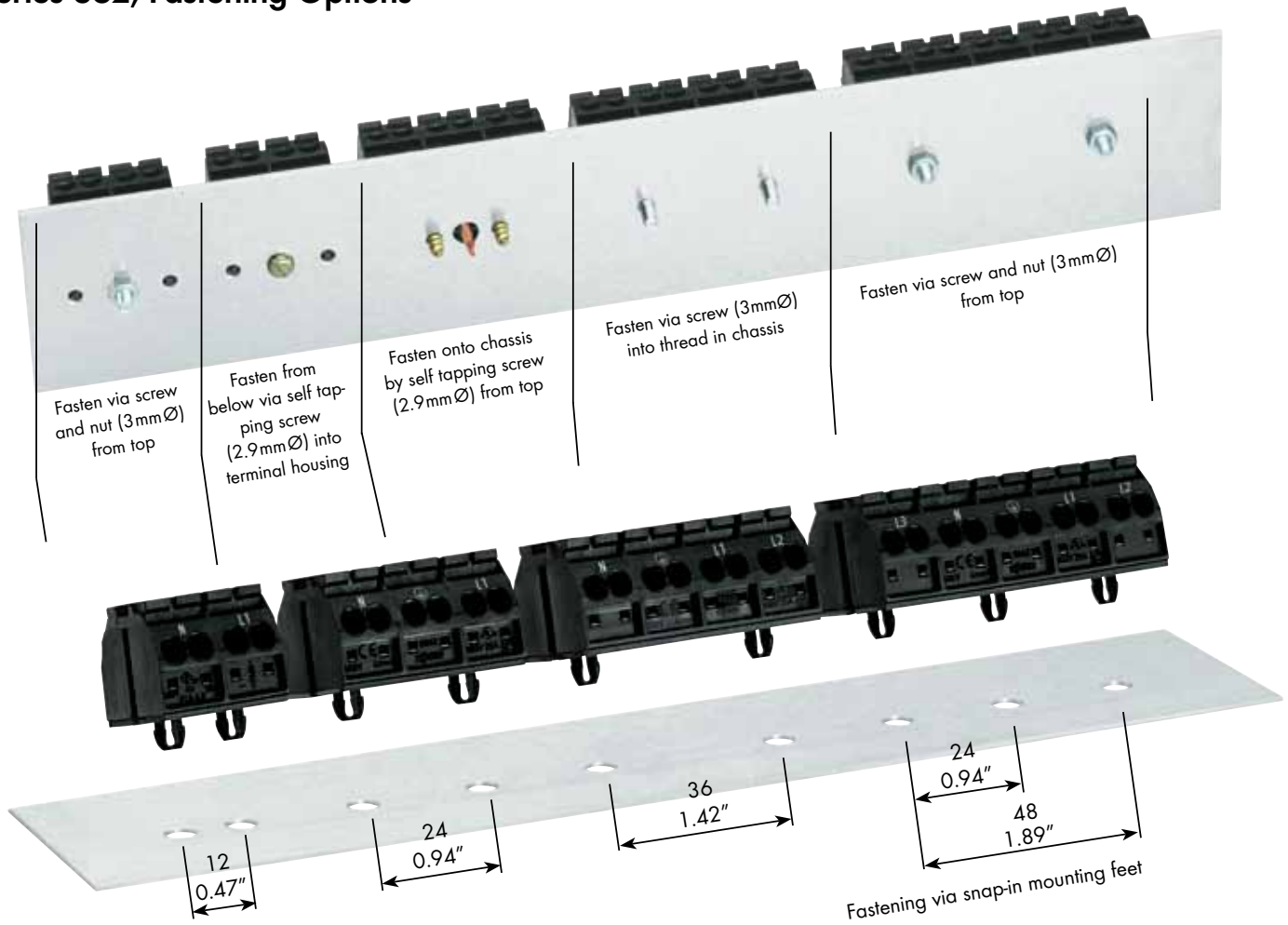

Dimensions (mm)

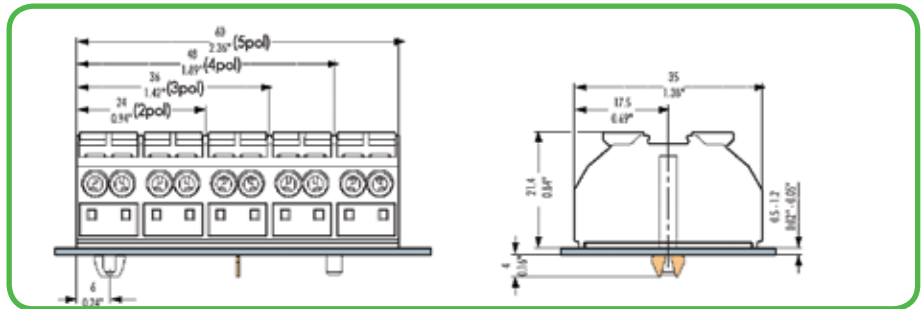
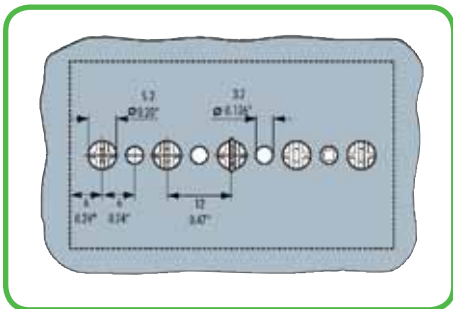

Mounting Foot









Item No.	Pack.-unit pcs
Mounting foot for DIN Rail mounting,	
209-120	25

Testing



Testing with test plug 2 mm Ø

Terminal Blocks for Chassis Mounting, Series 862

	<p>4 x 0.5 – 4 mm² 500 V/6 kV/2 32 A</p> <p>4 x AWG 22 - 12  4 x AWG 20 -12  300 V, 20 A 600 V, 5 A 600 V, 20 A **</p> <p> 10 – 11 mm / 0.41 in</p>	<p>4 x 0.5 – 4 mm² 500 V/6 kV/2 32 A</p> <p>4 x AWG 22 - 12  4 x AWG 20 -12  300 V, 20 A 600 V, 5 A 600 V, 20 A **</p> <p> 10 – 11 mm / 0.41 in</p>
--	---------------------------------------------------------------------------------------------------------------------------------------------------------------------------------------------------------------------------------------------------------------------------------------------------------------------------------------------------------------------------------------------------------------------------------------------	-------------------------------------------------------------------------------------------------------------------------------------------------------------------------------------------------------------------------------------------------------------------------------------------------------------------------------------------------------------------------------------------------------------------------------------------------

**  with conditions of acceptability

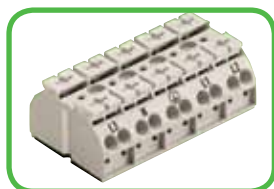

Available in black and white









2 poles /8 connection points



3 poles /12 connection points

without ground/ earth contact	with ground/ earth contact	Item No. black	Item No. white	Pack.-unit pcs	Item No. black	Item No. white	Pack.-unit pcs
for fastening screw 3 mm / 0.118 in Ø or for self tapping screw 2.9 mm / 0.114 in Ø from top							
without marking		862-0552	862-0652	500			
L1-N (pre-marked)		862-1552	862-1652	500			
N-L1 (pre-marked)		862-2552	862-2652	500			
for self tapping screw 2.9 mm / 0.114 mm Ø from below							
without marking		862-0562	862-0662	500			
L1-N (pre-marked)		862-1562	862-1662	500			
N-L1 (pre-marked)		862-2562	862-2662	500			
1 snap-in foot per pole							
without marking		862-0532	862-0632	500			
L1-N (pre-marked)		862-1532	862-1632	500			
N-L1 (pre-marked)		862-2532	862-2632	500			
for fastening screw 3 mm / 0.008 in Ø or for self tapping screw 2.9 mm / 0.114 in Ø from top							
without marking					862-0503	862-0603	250
PE-N-L1 (pre-marked)					862-1503	862-1603	250
N-PE-L1 (pre-marked)					862-2503	862-2603	250
(pre-marked) N-PE-L1					862-8503	862-8603	250
(pre-marked) PE-N-L1					862-9503	862-9603	250
1 snap-in foot per pole							
without marking					862-0533	862-0633	250
PE-N-L1 (pre-marked)					862-1533	862-1633	250
N-PE-L1 (pre-marked)					862-2533	862-2633	250
(pre-marked) N-PE-L1					862-8533	862-8633	250
(pre-marked) PE-N-L1					862-9533	862-9633	250
snap-in feet at pos. 1+3							
without marking					862-0593	862-0693	250
PE-N-L1 (pre-marked)					862-1593	862-1693	250
N-PE-L1 (pre-marked)					862-2593	862-2693	250
(pre-marked) N-PE-L1					862-8593	862-8693	250
(pre-marked) PE-N-L1					862-9593	862-9693	250

Accessories

<p>Comb-type jumper bar, can easily be inserted into the wire entry, 32 A</p>  <p>862-482 5</p>	<p>Test plug, with cable 500 mm / 1'7.7"</p>  <p>2 mm / 0.079 in Ø, red</p> <p>210-136 1</p>	<p>Test plug, with cable 500 mm / 1'7.7"</p>  <p>2.3 mm / 0.091 in Ø, yellow</p> <p>210-137 50 (5 x 10)</p>
<p>Screwdriver, with partially insulated shaft</p>  <p>(3.5 x 0.5) mm (.14 x .0025) in</p> <p>210-720 1</p>	<p>Marker strip, white, plain for central marking;</p>  <p>7.5 mm wide, on roll, 50 m long</p> <p>709-178 1</p>	<p>Marker strip, translucent, plain for central marking;</p>  <p>7.5 mm wide, on roll, 50 m long</p> <p>709-177 1</p>

Terminal Blocks for Chassis Mounting, Series 862

4 x 0.5 – 4 mm ² 500 V/6 kV/2 32 A	4 x AWG 22 - 12 4 x AWG 20 - 12 300 V, 20 A 600 V, 5 A 600 V, 20 A**	4 x 0.5 – 4 mm ² 500 V/6 kV/2 32 A	4 x AWG 22 - 12 4 x AWG 20 - 12 300 V, 20 A 600 V, 5 A 600 V, 20 A**
10 - 11 mm / 0.41 in		10 - 11 mm / 0.41 in	

** with conditions of acceptability



Available in black and white



4 poles /16 connection points



5 poles /20 connection points

without ground/ earth contact	with ground/ earth contact	Item No. black	Item No. white	Pack.-unit pcs	Item No. black	Item No. white	Pack.-unit pcs
for fastening screw 3 mm Ø or for self tapping screw 2.9 mm Ø from top							
without marking		862-0504	862-0604	200			
	PE-N-L1-L2 (pre-marked)	862-1504	862-1604	200			
	N-PE-L1-L2 (pre-marked)	862-2504	862-2604	200			
	(pre-marked) N-PE-L1-L2	862-8504	862-8604	200			
	(pre-marked) PE-N-L1-L2	862-9504	862-9604	200			
1 snap-in foot per pole							
without marking		862-0534	862-0634	200			
	PE-N-L1-L2 (pre-marked)	862-1534	862-1634	200			
	N-PE-L1-L2 (pre-marked)	862-2534	862-2634	200			
	(pre-marked) N-PE-L1-L2	862-8534	862-8634	200			
	(pre-marked) PE-N-L1-L2	862-9534	862-9634	200			
snap-in feet at pos. 1+4							
without marking		862-0594	862-0694	200			
	PE-N-L1-L2 (pre-marked)	862-1594	862-1694	200			
	N-PE-L1-L2 (pre-marked)	862-2594	862-2694	200			
	(pre-marked) N-PE-L1-L2	862-8594	862-8694	200			
	(pre-marked) PE-N-L1-L2	862-9594	862-9694	200			
for fastening screw 3 mm Ø or for self tapping screw 2.9 mm Ø from top							
without marking					862-0505	862-0605	200
	PE-N-L1-L2-L3 (pre-marked)				862-1505	862-1605	200
	L3-N-PE-L1-L2 (pre-marked)				862-2505	862-2605	200
	(pre-marked) L3-N-PE-L1-L2				862-8505	862-8605	200
	(pre-marked) PE-N-L1-L2-L3				862-9505	862-9605	200
1 snap-in feet at pos. 2+4							
without marking					862-0525	862-0625	200
	PE-N-L1-L2-L3 (pre-marked)				862-1525	862-1625	200
	L3-N-PE-L1-L2 (pre-marked)				862-2525	862-2625	200
	(pre-marked) L3-N-PE-L1-L2				862-8525	862-8625	200
	(pre-marked) PE-N-L1-L2-L3				862-9525	862-9625	200
snap-in feet at pos. 1+3+5							
without marking					862-0515	862-0615	200
	PE-N-L1-L2-L3 (pre-marked)				862-1515	862-1615	200
	L3-N-PE-L1-L2 (pre-marked)				862-2515	862-2615	200
	(pre-marked) L3-N-PE-L1-L2				862-8515	862-8615	200
	(pre-marked) PE-N-L1-L2-L3				862-9515	862-9615	200

Ferrules		Sleeve for mm ²	AWG	Color	Stripped length mm	L	L1	D mm	D	D2	Item No.	Pack.-unit pcs
	Insulated ferrules	0.5	22	white	12.0	16.0	10.0	3.1	2.6	1.0	216-241	1000
		0.75	20	grey	12.0	16.0	10.0	3.3	2.8	1.2	216-242	1000
		1.0	18	red	12.0	16.0	10.0	3.5	3.0	1.4	216-243	1000
		1.5	16	black	12.0	16.0	10.0	4.0	3.5	1.7	216-244	1000
	Uninsulated ferrules	0.5	22		10	10		2.1		1.0	216-141	1000
		0.75	20		10	10		2.3		1.2	216-142	1000
		1.0	18		10	10		2.5		1.4	216-143	1000
		1.5	16		10	10		2.8		1.7	216-144	1000

Tools					
	Crimp Tool		Stripper / Cutter		Thermal Transfer Printer TP-343
	206-204		206-124		258-343/PW05-0100
	0.25 - 4 mm ²		0.02 - 10 mm ²		
	AWG 24 - 12		AWG 34 - 8		

Carrier Rails, Series 210

Carrier rail 35 x 7.5 mm,
1-mm/0.039 in thick,
acc. to EN 60715,
Steel, zinc-plated and yellow chromated
I_N 76 A (referred to a length of 1 m)

Carrier rail 35 x 15 mm,
1.5 mm/0.059 in and 2.3 mm/0.091 in thick,
acc. to EN 60715,
Steel, zinc-plated and yellow chromated
I_N 125 A (referred to a length of 1 m)

Carrier rail 35 x 15 mm,
2.3 mm/0.091 in thick,
acc. to EN 60715,
Copper, unplated
I_N 309 A (referred to a length of 1 m)

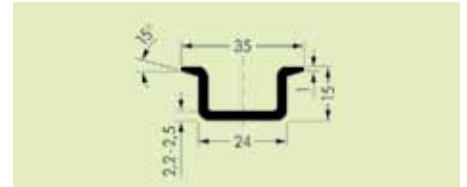
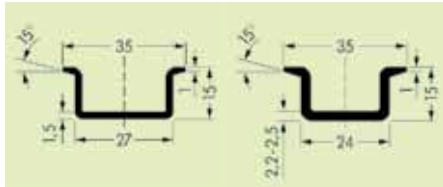
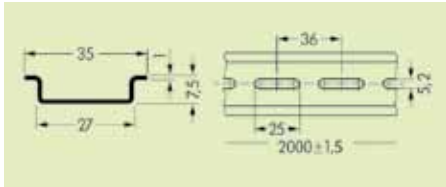
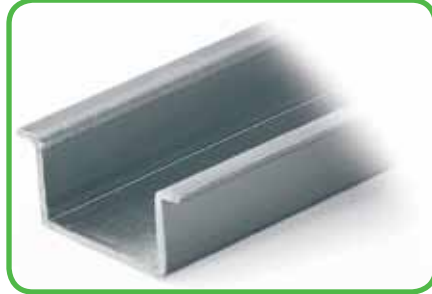

Item No.	Pack.-unit pcs	Item No.	Pack.-unit pcs	Item No.	Pack.-unit pcs
Steel rail 35 x 7.5 mm, 1 mm/0.039 in th., unslotted 2 m/6'6" long 210-113	10	Steel rail 35 x 15 mm, 2 m/6'6" long 1.5 mm thick 210-114 unslotted	10	Copper carrier rail 35 x 15 mm, 2.3 mm/0.091 in thick, unslotted 2 m/6'6" long 210-198	10
Steel rail 35 x 7.5 mm, 1 mm/0.039 in th., slotted 2 m/6'6" long 210-112	10	1.5 mm thick 210-197 slotted	10		
		2.3 mm thick 210-118 unslotted	10		

Angled support bracket
Steel, zinc-plated and yellow chromated

End Stop

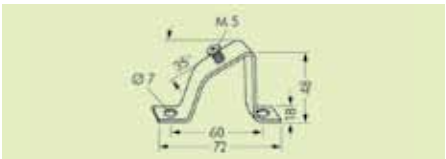

Item No.	Pack.-unit pcs	Item No.	Pack.-unit pcs
Angled support bracket, without screw 210-148	10	6 mm wide 249-116	100
Screw M 5 x 8 210-149	100 (5 x 20)	10 mm wide 249-117	100

Operating Tools, Series 210, Series 209

<p>Screwdrivers with partially insulated shaft for optimum handling of CAGE CLAMP® connection in terminal blocks and connectors</p>	<p>Multipole operating tools for front-entry terminal blocks (insulated)</p>	<p>Screwdrivers (DIN 5264) for optimum handling of CAGE CLAMP® connection in terminal blocks and connectors</p>
--------------------------------------------------------------------------------------------------------------------------------------------	-------------------------------------------------------------------------------------	------------------------------------------------------------------------------------------------------------------------



Item No.	Pack.-unit pcs	Item No.	Pack.-unit pcs	Item No.	Pack.-unit pcs
Screwdriver, with partially insulated shaft, blade 2.5 x 0.4 mm/0.098 x 0.016 in suitable for series 218, 233, 234, 235, 250, 253, 279, 733, 734, 735, 770, 2001	210-719	1	Operating tool, solid non-conducting material suitable for series 279 1-way	209-129	1
Screwdriver, with partially insulated shaft, blade 3.5 x 0.5 mm/0.137 x 0.020 in suitable for series 231, 232, 236, 255, 256, 257, 264, 280, 281, 721, 722, 736, 737, 738, 742, 745, 804, 869, 2002, 2004	210-720	1	suitable for series 279 2-way	279-432	1
Screwdriver, with partially insulated shaft, blade 5.5 x 0.8 mm/0.217 x 0.031 in suitable for series 282, 283, 284, 285, 745, 2006, 2010, 2016	210-721	1	3-way	279-433	1
Screwdriver, with partially insulated shaft, - set -, consists of 210-719, 210-720 und 210-721	210-722	1	10-way	279-440	1
			suitable for series 264*, 280, 281**	1-way	209-130
			1-way	209-130	1
			2-way	280-432	1
			3-way	280-433	1
			4-way	280-434	1
			5-way	280-435	1
			6-way	280-436	1
			7-way	280-437	1
			8-way	280-438	1
			9-way	280-439	1
			10-way	280-440	1
			Operating tool with partially insulated shaft, (3.5 x 0.5) mm blade, short, for 260, 261, 262, 264, 270, 280, 281, 869, 870, 880 Series	210-657	1
			Operating tool with partially insulated shaft, (3.5 x 0.5) mm blade, short angled, ideal for 280 Series actuator and sensor terminal blocks, along with 231, 232, 236, 255, 256, 257, 260, 261, 262, 264, 280, 281, 721, 736, 738, 742, 745, 804, 869, 870, 880, 2002 and 2004 Series	210-658	1
			5-way	281-440	1
			* only 1- and 2-way		
			** only up to 3-way		

Application notes



Set of screwdrivers in a box



Commoning of front-entry through terminal blocks with comb type jumper bars with the aid of a 10-way operating tool



The blade dimensions of the a. m. screwdrivers (DIN 5264) are particularly appropriate for easy front-entry sensor and actuator terminal blocks of series 280

Voltage Tester, Testboy and Banana Plugs, Series 206, Series 215

<p>Voltage tester Profipol 12 V to 400 V AC 12 V to 500 V DC</p> <p>Weight 138 g / 0.304 lbs</p>	<p>Testboy</p>	<p>Banana plugs for sockets Ø 4 mm 0.08 – 2.5 mm² AWG 28 – 14 42 V 20 A L 9 – 11 mm / 0.39 in</p>
----------------------------------------------------------------------------------------------------------	----------------	--------------------------------------------------------------------------------------------------------------------------------

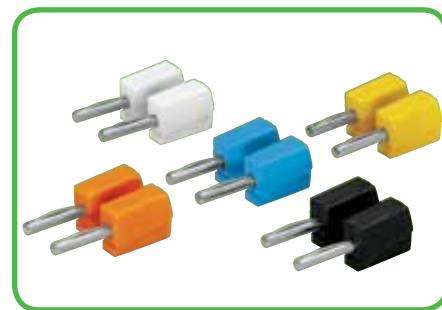
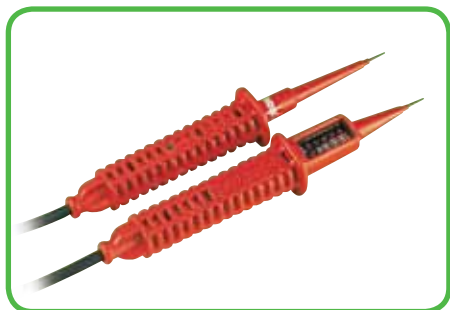

Item No.	Pack.-unit pcs	Item No.	Pack.-unit pcs	Item No.	Pack.-unit pcs
Voltage tester Profipol		Testboy, with integrated flashlight		Banana plugs, for sockets Ø 4 mm	
206-802	1	206-804	1	color mixed	50
Voltage range	AC 12V to 400V DC 12V to 500V	Voltage range	120V up to AC 1000V	orange, blue, yellow, white, black	
LED indication AC	12V, 50V, 100V, 230V, 400V			Banana plugs, for sockets Ø 4 mm	
DC	12V, 60V, 120V, 280V, 500V			orange	50
Type of protection	IP 65			red	50
Operating time	30 s max.			black	50
Temperature range	-10° up to + 50° C			green	50
				yellow	50
				blue	50
				grey	50
				green-yellow	50

Application notes



Voltage testing of pushwire connectors

- LED band provides clear voltage range readings (white scale = AC voltage red scale = DC voltage)
- LED indication of polarity
- Double-pole voltage testing
- Type of protection IP 65
- Switching is not necessary
- 85 cm long highly flexible and nonskid test cable



A device that will reliably detect AC voltages in cables, sockets, fuses, switches, connector boxes, etc.

The following can be detected by the WAGO Testboy:

- Live conductors
- Line breaks
- Blown fuses
- Defective switches
- Defective lamps





Connection of conductors:
Press button fully and insert stripped conductor into square entry and release

Wire Cutter and Stripping Tools, Series 206

<p>Wire cutter acc. to VDE for copper and aluminum wires up to 35 mm²/2 AWG</p> <p>Weight 200 g / 0.441 lbs</p>	<p>Quickstrip 10 wire stripper 0.02 mm² – 10 mm² "f-st" (6 mm² "s") wire cutter up to 10 mm² "f-st" (1.5 mm² "s") 34 - 8 AWG Weight 136 g / 0.297 lbs</p>	<p>Quickstrip 16 wire stripper 4 mm² – 16 mm² wire cutter up to 10 mm² "f-st" (1.5 mm² "s") 12 - 6 AWG Weight 136 g / 0.297 lbs</p>
----------------------------------------------------------------------------------------------------------------------------	----------------------------------------------------------------------------------------------------------------------------------------------------------------------------------------------------------------------------------	-------------------------------------------------------------------------------------------------------------------------------------------------------------------------------------------------



Item No.	Pack.-unit pcs	Item No.	Pack.-unit pcs
Wire cutter 206-118	1	Stripping tool Quickstrip 10 206-124	1
		Stripping tool Quickstrip 16 206-125	1

Accessories, Series 206			
	<p>Standard blade cassette</p> <p>0.02 mm² up to 10 mm²</p> <p> 206-126 1</p>	<p>Standard blade cassette</p> <p>4 mm² up to 16 mm²</p> <p> 206-128 1</p>	
	<p>"V" blade cassette</p> <p>0.02 mm² up to 4 mm² for PTFE</p> <p> 206-127 1</p>		

Application notes



Cutting of wire



Quickstrip 16: Stripping of wire



Quickstrip 16 Cutting of wire

- Automatic adjustment to wire size
- No damage to wire strands
- Gripping pressure of jaws adjusts automatically to wire insulation diameter
- Full cycle strip – jaws open after stripping, ensures no nicked strands
- Exact strip length may be set by sliding of black setting stop
- Replaceable stripping jaw assembly
- Self-sharpening, fully protected wire cutter
- Glass fiber reinforced polyamide tool body

Crimping Tool Variocrimp 4, Variocrimp 16, Ferrules, Series 206, Series 216

<p>Crimping tools for ferrules insulated or uninsulated</p> <p>Variocrimp 4 from 0.25 mm² – 4 mm² Weight 400 g / 0.882 lbs</p> <p>Variocrimp 16 from 6 mm² – 16 mm² Weight 580 g / 1.28 lbs</p>	<p>Insulated ferrules</p>
-----------------------------------------------------------------------------------------------------------------------------------------------------------------------------------------------------------------------------------------------------	---------------------------



Item No.	Pack.-unit pcs	Sleeve for mm ² AWG	Color	Stripped length mm	L	L1	D mm	D1	D2	Item No.	Pack.-unit pcs
Variocrimp 4 206-204 0.25 mm ² - 4 mm ² / AWG 24 - 12	1	0.25 24	yellow	7.5	10.5	6.0	2.5	2.0	0.8	216-321	1000
		0.25 24	yellow	9.5	12.5	8.0	2.5	2.0	0.8	216-301	1000
		0.35 24	green	7.5	10.5	6.0	2.5	2.0	0.8	216-322	1000
		0.34 24	green	9.5	12.5	8.0	2.5	2.0	0.8	216-302	1000
Variocrimp 16 206-216 6 mm ² - 16 mm ² / AWG 10 - 6	1	0.5 22	white	7.5	11.5	6.0	3.0	2.5	1.1	216-221	1000
		0.5 22	white	9.5	13.5	8.0	3.0	2.5	1.1	216-201	1000
		0.75 20	grey	8.0	12.0	6.0	3.3	2.8	1.3	216-222	1000
		0.75 20	grey	10.0	14.0	8.0	3.3	2.8	1.3	216-202	1000
		1.0 18	red	8.0	12.0	6.0	3.6	3.0	1.5	216-223	1000
		1.0 18	red	10.0	14.0	8.0	3.6	3.0	1.5	216-203	1000
		1.5 16	black	8.0	12.0	6.0	4.0	3.4	1.8	216-224	1000
		1.5 16	black	10.0	14.0	8.0	4.0	3.4	1.8	216-204	1000
		2.08 14	yellow	10.0	14.5	8.0	4.2	3.6	2.05	216-205	1000
		2.5 14	blue	10.0	15.0	8.0	4.8	4.2	2.3	216-206	1000
		4.0 12	grey	12.0	16.8	9.5	5.4	4.8	2.9	216-207	1000
		6.0 10	yellow	14.0	20.0	12.0	6.8	6.2	3.5	216-208	100
10.0 8	red	16.0	21.0	12.0	8.1	7.5	4.6	216-209	100		
16.0 6	blue	23.0	29.0	18.0	9.6	8.8	5.8	216-210	100		

Application notes



Introduce conductor with ferrule into crimping station. Squeeze handles until ratchet mechanism is released.

- With the Variocrimp 4, the built-in crimping pressure control automatically adjusts the crimping force to the conductor cross section used. With the Variocrimp 16 it is necessary to select the wire gauge on the tool before crimping.
- Each tool has only one crimping station for all wire sizes handled.
- Uniform compact crimping from all four sides for high conductor retention.
- No necessity to centralize the conductor into the terminal ferrule.
- Conductor and ferrule insertion possible from both sides (for left and right handers).
- Built-in ratchet to guarantee complete crimping every time.
- Tools open automatically after crimping operation is complete.
- Comfortable handles for operator.

Insulated ferrules, extra long, for TOBJOB®S and 862 Series terminal blocks											
0.5	22	white	12.0	16.0	10.0	3.1	2.6	1.0	216-241	1000	
0.75	20	grey	12.0	16.0	10.0	3.3	2.8	1.2	216-242	1000	
0.75	20	grey	14.0	18.0	12.0	3.3	2.8	1.2	216-262	1000	
1.0	18	red	12.0	16.0	10.0	3.5	3.0	1.4	216-243	1000	
1.0	18	red	14.0	18.0	12.0	3.5	3.0	1.4	216-263	1000	
1.5	16	black	12.0	16.0	10.0	4.0	3.5	1.7	216-244	1000	
1.5	16	black	14.0	18.0	12.0	4.0	3.5	1.7	216-264	1000	
1.5	16	black	20.0	24.0	18.0	4.0	3.5	1.7	216-284	1000	
2.5	14	blue	12.0	17.0	10.0	4.7	4.2	2.2	216-246	1000	
2.5	14	blue	14.0	19.0	12.0	4.7	4.2	2.2	216-266	1000	
2.5	14	blue	20.0	25.0	18.0	4.7	4.2	2.2	216-286	1000	
4.0	12	grey	14.0	20.0	12.0	5.4	4.8	2.8	216-267	500	
4.0	12	grey	20.0	26.0	18.0	5.4	4.8	2.8	216-287	500	
6.0	10	yellow	14.0	20.0	12.0	6.9	6.3	3.5	216-208	500	
6.0	10	yellow	20.0	26.0	18.0	6.9	6.3	3.5	216-288	500	
10.0	8	red	20.0	28.0	18.0	8.4	7.6	4.5	216-289	500	
16.0	6	blue	23.0	28.0	18.0	9.6	8.8	5.8	216-210	500	

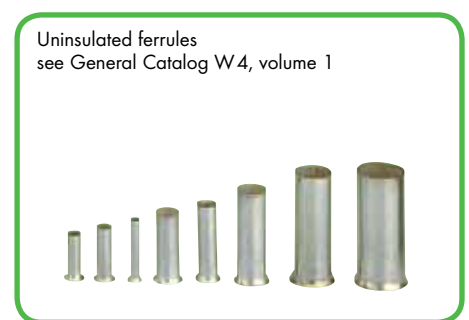
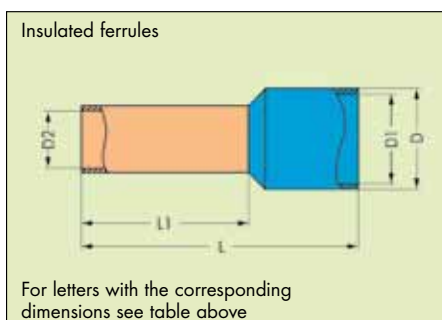

TTP-345 Thermal Transfer Printer



Thermal Transfer Printer

+

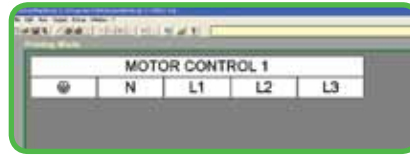

ProServe Software
 • Unique multi-line marking

=



Marked 862 Series

Item No.	Item No.	Item No.
Thermal Transfer Printer 258-345/0000-0100	Marker strips	Ink ribbon
Print resolution 300 dpi	For series 862, 7.5 mm, white	38 mm 258-145 300 m
Print speed up to 76 mm/sec.	709-178 50 m	100 mm 258-157 300 m
Software: ProServe Software; smartMARKING		
Download at www.wago.us	For series 862, 7.5 mm, translucent	
Consult Factory	709-177 50 m	

Wire Marking with TTP-345



211-155; 211-156



211-111...115; 211-121...125;
 211-129 (shown)

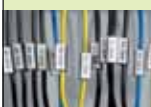

211-161; 211-162

Item No.	Item No.	Item No.
Marker card for TT printer, 12 mm 211-111	Labels on roll for thermal transfer printers	3 to 1 pre-flattened polyolefin heat shrink tubing, 100 ft
Slides into marking sleeves below	Marker surface "S" = 8 mm, "B" = 18 mm,	1/8" (18 - 24 AWG), diam. before/after shrinking .125/.039 in
For various wire sizes	"L" = 35 mm for cable diameter max. 9 mm	white 51223870
1.6-3.2 mm or 0.25 mm ² -1.5 mm ² 211-112	9000 labels per roll 211-155	yellow 51227742
2.2-4.5 mm or 0.5 mm ² -4 mm ² 211-113		
3.7-5.9 mm or 2.5 mm ² -6 mm ² 211-114	Marker surface "S" = 13 mm, "B" = 23 mm,	3/16" (12-18 AWG), diam. before/after shrinking .187/.059 in
4.8-7.5 mm or 6 mm ² -16 mm ² 211-115	"L" = 51 mm for cable diameter max. 12 mm	white 51223870
	5000 labels per roll 211-156	yellow 51227743
Marker card for TT printer, 23 mm 211-121	Core marker for threading	1/4" (6 - 10 AWG), diam. before/after shrinking .250/.083 in
Slides into marking sleeves below	on roll, 2,000 pcs,	white 51223870
For various wire sizes	white / 0.75 - 1.5 mm 211-161	yellow 51227744
1.6-3.2 mm or 0.25 mm ² -1.5 mm ² 211-122	on roll, 2,000 pcs,	
2.2-4.5 mm or 0.5 mm ² -4 mm ² 211-123	white / 2.5 - 6.0 mm 211-162	
3.7-5.9 mm or 2.5 mm ² -6 mm ² 211-124		
4.8-7.5 mm or 6 mm ² -16 mm ² 211-125		
Marking sleeve for cable tie, 23 mm,		
for single cores from 10 mm 211-129		
Cable tie, (2.5 x 100) mm		
807-0090/0101-0100		
 211-121 with marking sleeve		

Notes

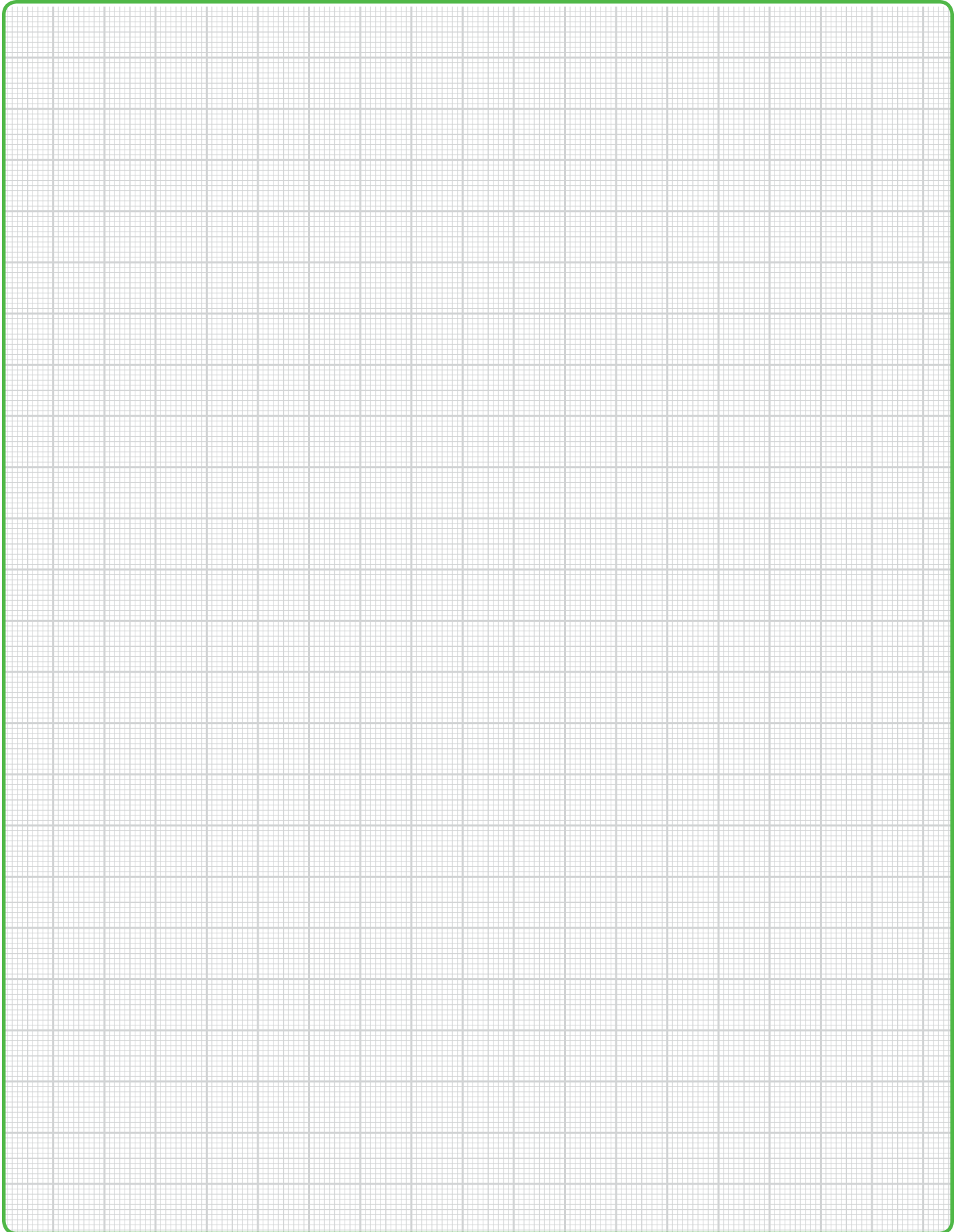

Notes

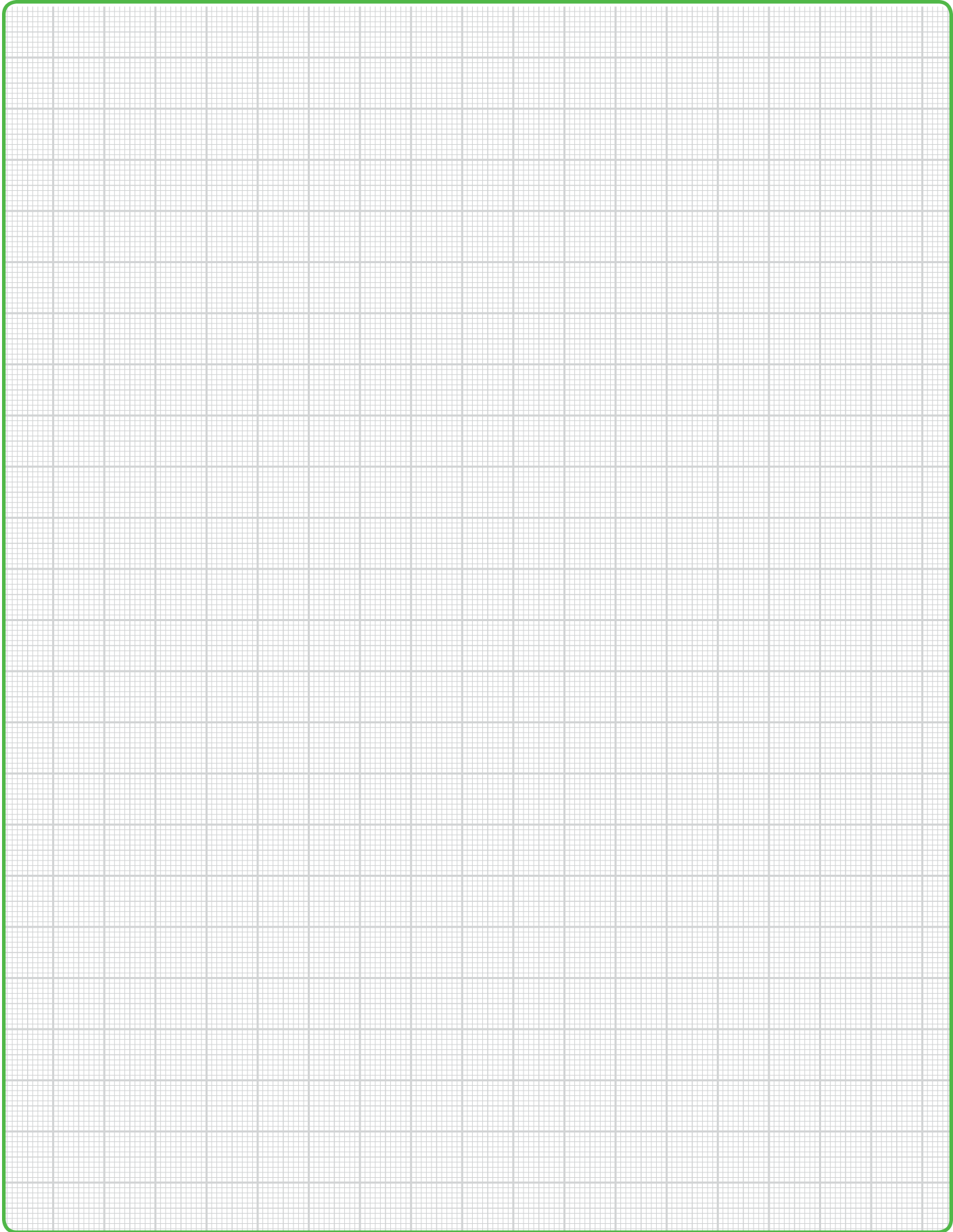

Notes

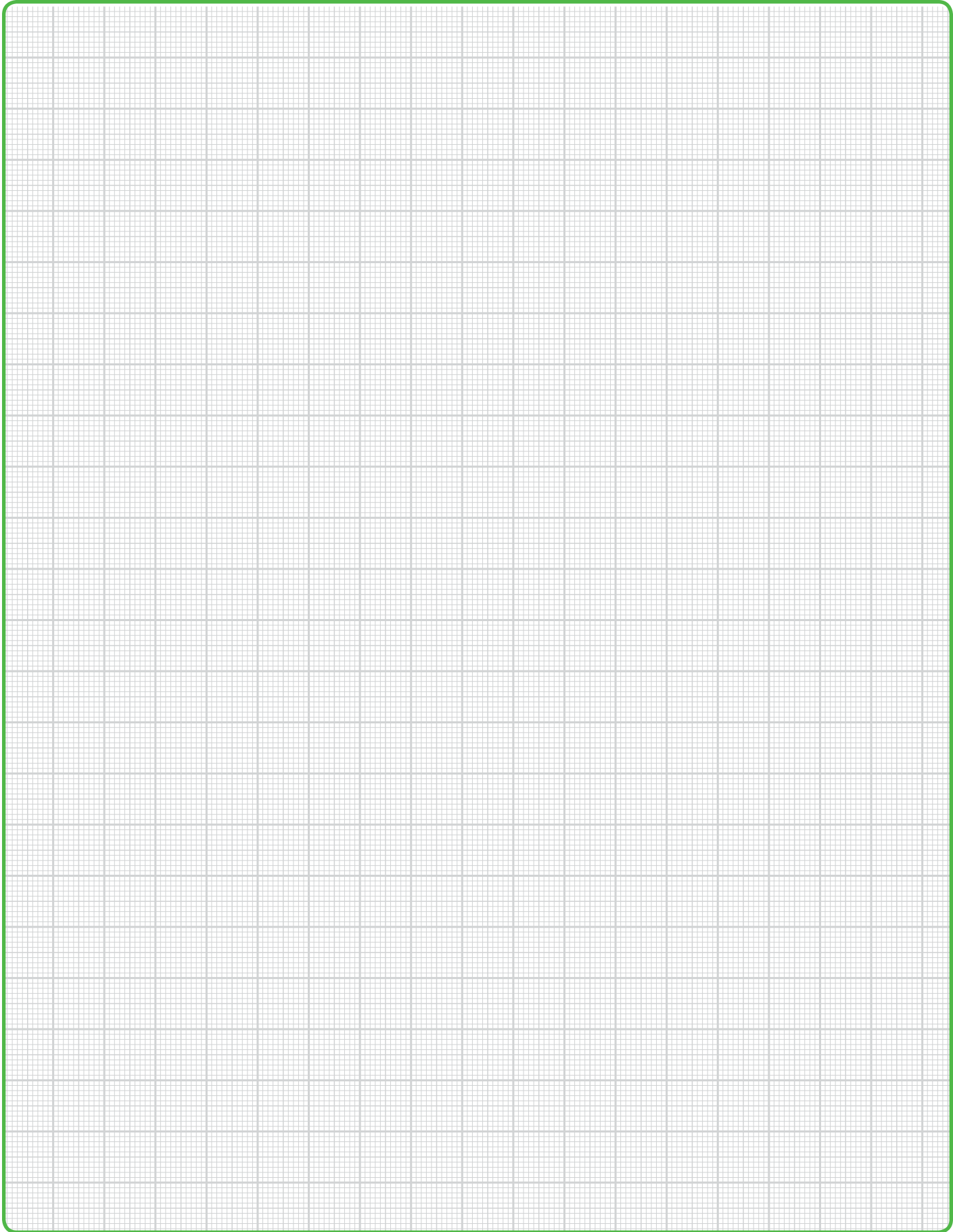

WAGO Service Worldwide

Germany

WAGO Kontakttechnik
Minden
Tel. ++49/571/887/0
Fax ++49/571/887/169

Austria

WAGO Kontakttechnik
Wien
Tel. ++43/1/615/07/80
Fax ++43/1/615/07/75

Belgium

WAGO Kontakttechnik
Zaventem
Tel. ++32/2/7/17/90/90
Fax ++32/2/7/17/90/99

China

WAGO ELECTRONIC Co. Ltd.
Tianjin
Tel ++86/22/59617688
Fax ++86/22/59617668

England

WAGO, Ltd.
Rugby
Tel. ++44/1788/568008
Fax ++44/1788/568050

France

WAGO CONTACT S.A.
Paris
Tel. ++33/148172590
Fax ++33/148632520

Italy

WAGO ELETTRONICA SRL
Casalecchio di Reno (BO)
Tel. ++39/051/6132112
Fax ++39/051/6272174

Japan

WAGO Co. of JAPAN Ltd.
Tokyo
Tel. ++81/3/5627/2050
Fax ++81/3/5627/2055

Poland

WAGO ELWAG sp. z o. o.
Wroclaw
Tel. ++48/71/3604670/78
Fax ++48/71/3604699

Singapore

WAGO Electronic Pte. Ltd.
Singapore
Tel. ++65/62866776
Fax ++65/62842425

Switzerland

WAGO CONTACT SA
Domdidier
Tel. ++41/26/676/75/86
Fax ++65/26/676/75/01

Mexico

WAGO Corporation
Queretaro
Tel. 001/800/309/5975
+ 52/442/221/5946
Fax + 52/442/221/5063

Canada

WAGO Corporation
Tel. 800/DIN Rail (346-7245)
Fax 262/255-3232

WAGO Corporation
N120 W19129 Freistadt Road
Germantown, Wisconsin 53022
Telephone: 800 / DIN Rail (346-7245)
Fax: 262 / 255-3232
info.us@wago.com
www.wago.us

