

Item no.: 231-604/019-000
 Product description: MALE CONNECTOR; WITH FIXING FLANGE; 4 POLE; PIN SPACING 5 MM / 0.197 IN; CAGE CLAMP®CONNECTION; FOR SCREW OR SIMILAR MOUNTING TYPES

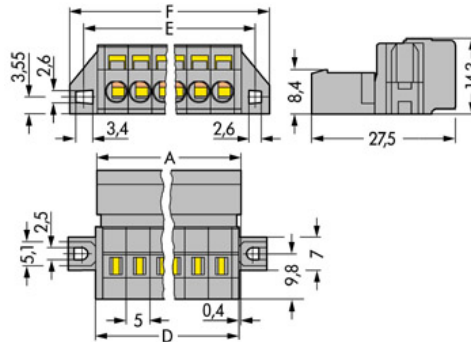

Packing unit 50 pieces

Product group	3 (Multi Conn. System)
Pin spacing from	5 mm
Pin spacing from	0,197 in
pole count	4
Cross section from [mm ²]	0,08 mm ²
Cross section to [mm ²]	2,5 mm ²
Cross section from [AWG]	28 AWG
Cross section to [AWG]	12 AWG
Connection method	CAGE CLAMP®CONNECTION
Measured voltage EN	250 V
Measured shock voltage	4 kV
Pollution degree	3
Current intensity EN	12 A
Weight	7,3 g
Color	grey
No. of connection Points	4
No. of potentials	4
Height	14,3 mm
Height	0,563 in
Width	34,8 mm
Width	1,37 in
Depth	27,5 mm



Depth	1,083 in
Strip length from	8 mm
Strip length to	9 mm
Strip length	0,33 in



Item number	Admission office	Approval no.	Voltage [V]	Current [A]	Cross section [mm ²]
231-604/019-000	ABS	04-HG469925-PDA	400	12	5,0
231-604/019-000	BV	11915/A0	400	16	2,5
231-604/019-000	CCA	5764	250	12	0,08-2,5
231-604/019-000	CSA	154112-1466354	300	15	22-12
231-604/019-000	DEMKO	88126	250		2,5
231-604/019-000	GL	17296-00HH	400	12	5,0
231-604/019-000	KEMA	2083746.02	250	12	0,08-2,5
231-604/019-000	KR	HMB05880-EL003	250/400	12/16	2,5
231-604/019-000	LR	96/20035	400	12	5,0
231-604/019-000	NEMKO	P94101840	250		2,5
231-604/019-000	RMR	11130002	400	12	5,0
231-604/019-000	UR	E45171	600	15	12
231-604/019-000	UR	E45172	300	15	22-12

Sorting criteria: admission office - approval number

© WAGO Kontakttechnik GmbH & Co. KG

Specifications are subject to changes and errors may be expected