

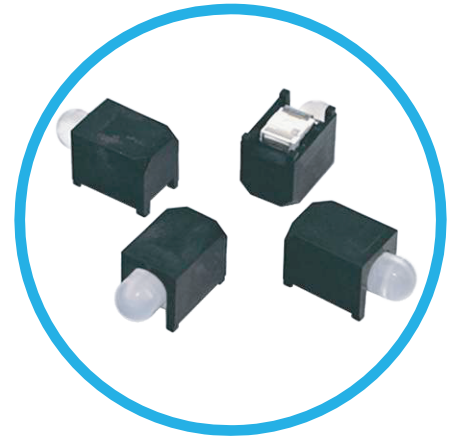

6300T Series 3mm (T-1) LED SMD Right Angle Circuit Board Indicator



6300T15 - Red/Green
Single level Surface Mount CBI, available in five different LED colors



Applications

- Industrial
- Infrastructure
- Storage Servers
- Switchers
- Telecommunications
- Medical
- Food Service
- IoT
- Automation & Control

Key Features

- Surface mount device
- LED Bulb Size: 0.112" (2.85mm)
- Compatible with automatic placement equipment
- Compatible with infrared and vapor phase solder processes
- Black case enhances contrast ratio
- Housing material meets UL94V-0
- Lens material meets UL94-HB
- Black housing enhances contrast ratio equipment
- Compliant with RoHS and REACH requirements
- Elimination of Mixed Technology Boards (SMT and Through-Hole components)
- Available in automation-friendly tape and reel
- Available in 3 different colors (red, green and yellow) and 2 different bi-colors (red/green and green/yellow)
- Red - Made with GaAsP/GaP
- Green - Made with GaP
- Diffused Lens
- Viewing Angle: 50 degrees
- Moisture Sensitive Level (MSL): 3
- Package: 1000 pcs/reel

Ordering Data

Part Number*	Color	Reel Qty
6300T1	Red	1,000 pcs/reel
6300T5	Green	1,000 pcs/reel
6300T7	Yellow	1,000 pcs/reel
6300T15	Red/Green	1,000 pcs/reel
6300T75	Yellow/Green	1,000 pcs/reel

*Please consult the specific product data sheet for others colors

Product Dimensions

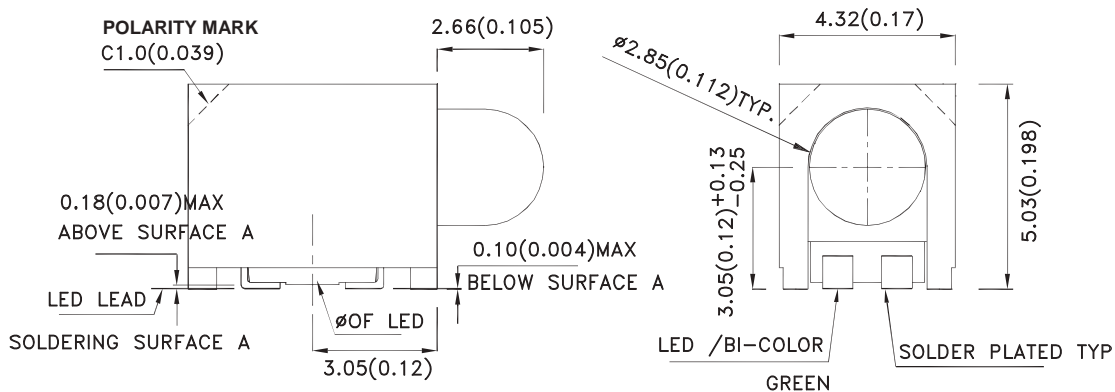

Recommended Soldering Pattern

Tolerance: $\pm 0.1 (0.004)$

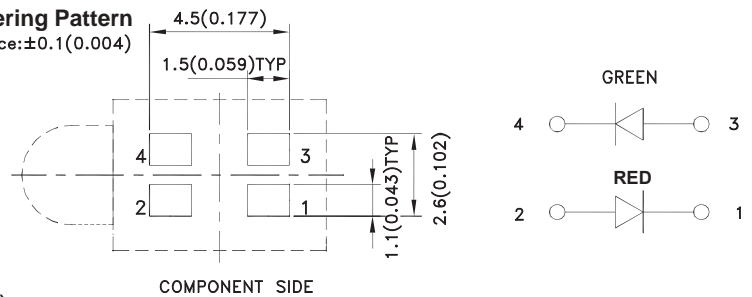

Notes:

1. All dimensions are in millimeters (inches).
2. Tolerance is ± 0.25 mm (0.01") unless otherwise noted.
3. The specifications, characteristics and technical data described in the datasheet are subject to change without prior notice
4. The device has a single mounting surface. The device must be mounted according to the specifications.

Product Specifications

Part No.	Emitting Color (Material)	Lens Type	Iv (mcd) [2] @ 20mA		Viewing Angle [1]
			Min.	Typ.	2 θ 1/2
6300T15	High Efficiency Red (GaAsP/GaP)	Diffused	3	6.7	50°
	Super Bright Green (GaP)		5	9	

Notes:

1. θ 1/2 is the angle from optical centerline where the luminous intensity is 1/2 of the optical peak value.
2. Luminous intensity / luminous Flux: +/-15%.
3. Luminous intensity value is traceable to CIE127-2007 standards.

Electrical / Optical Characteristics at TA=25°C

Symbol	Parameter	Emitting Color	Typ.	Max.	Units	Test Conditions
λ_{peak}	Peak Wavelength	High Efficiency Red Super Bright Green	627 565		nm	I _F =20mA
λ_D [1]	Dominant Wavelength	High Efficiency Red Super Bright Green	617 568		nm	I _F =20mA
$\Delta\lambda_{1/2}$	Spectral Line Half-width	High Efficiency Red Super Bright Green	45 30		nm	I _F =20mA
C	Capacitance	High Efficiency Red Super Bright Green	15 15		pF	V _F =0V;f=1MHz
V _F [2]	Forward Voltage	High Efficiency Red Super Bright Green	2 2.2	2.5 2.5	V	I _F =20mA
I _R	Reverse Current	High Efficiency Red Super Bright Green		10 10	uA	V _R = 5V

Notes:

1. Wavelength: +/-1nm.
2. Forward Voltage: +/-0.1V.
3. Wavelength value is traceable to CIE127-2007 standards.
4. Excess driving current and / or operating temperature higher than recommended conditions may result in severe light degradation or premature failure.

Absolute Maximum Ratings at TA=25°C

Parameter	High Efficiency Red	Super Bright Green	Units
Power Dissipation	75	62.5	mW
DC Forward Current	30	25	mA
Peak Forward Current [1]	160	140	mA
Reverse Voltage	5		V
Operating / Storage Temperature	-40°C To +85°C / -40°C To +100°C		

Notes:

1. 1/10 Duty Cycle, 0.1ms Pulse Width.
2. Relative humidity levels maintained between 40% and 60% in production area are recommended to avoid the build-up of static electricity – Ref JEDEC/JESD625-A and JEDEC/J-STD-033.

Product Specifications

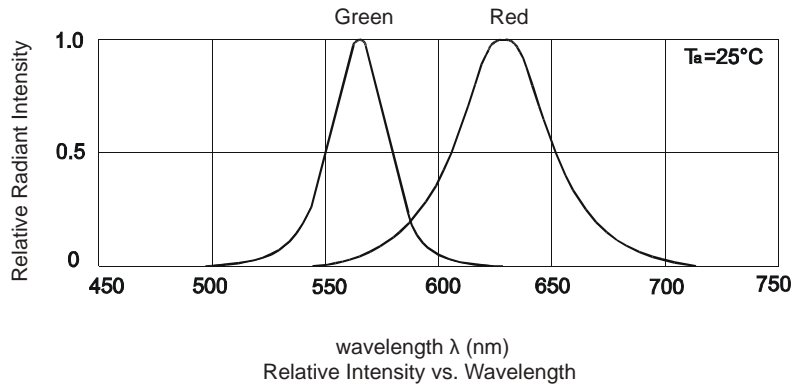

High Efficiency Red

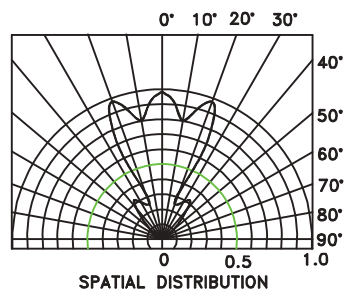
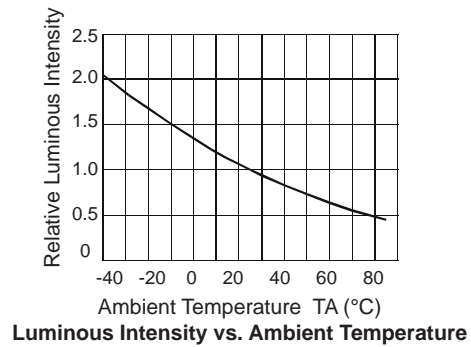
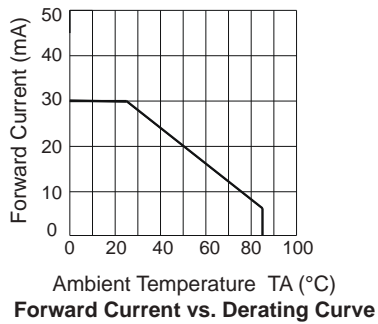
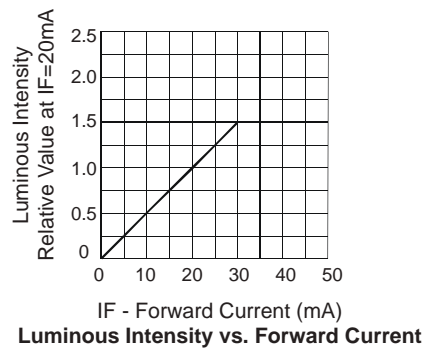
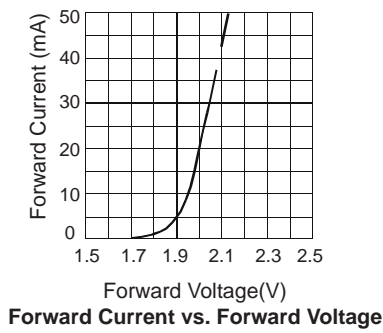

Product Specifications

Super Bright Green

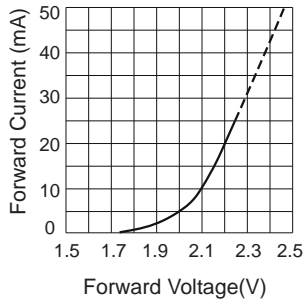

Forward Current vs. Forward Voltage

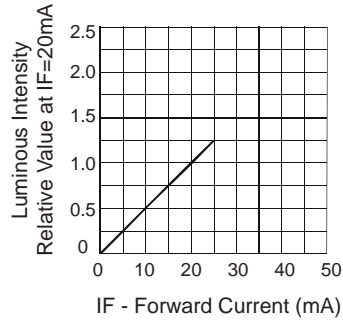

Luminous Intensity vs. Forward Current

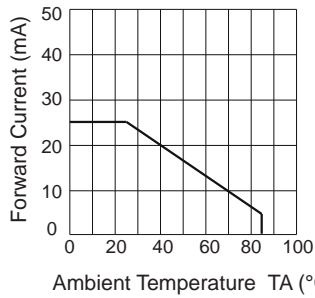

Forward Current vs. Derating Curve

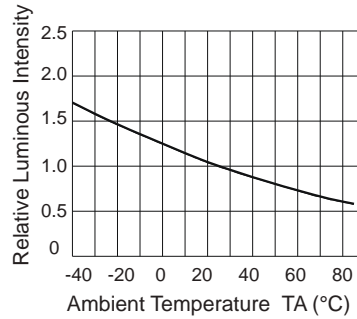

Luminous Intensity vs. Ambient Temperature

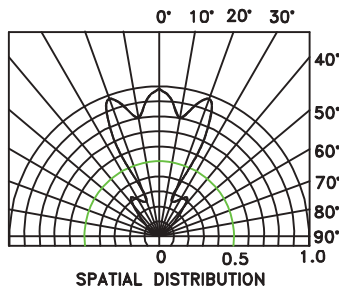

Test Conditions : IF=20mA Ta=25°C RH<75%RH

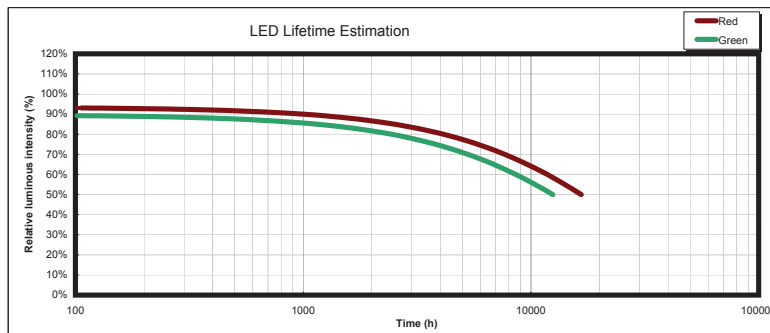

*Data shown is a simulation trend with extrapolation from the actual result of 1000h testing. The inferential time may change with prolonged life time test. Samples should be tested from 1000h to 6000h if more accurate data is required.

Packaging Specifications

Reflow soldering is recommended and the soldering profile is shown below. Other soldering methods are not recommended as they might cause damage to the product.

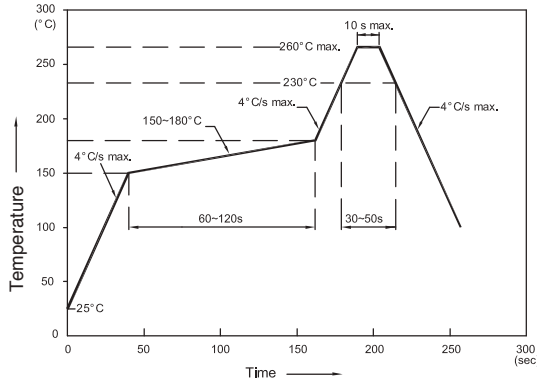

NOTES:

1. We recommend the reflow temperature $245^{\circ}\text{C} (+/-5^{\circ}\text{C})$. The maximum soldering temperature should be limited to 260°C .
2. Don't cause stress to the epoxy resin while it is exposed to high temperature
3. Number of reflow process shall be 2 times or less.

Recommended Soldering Pattern (Units: mm; Tolerance: ± 0.1)

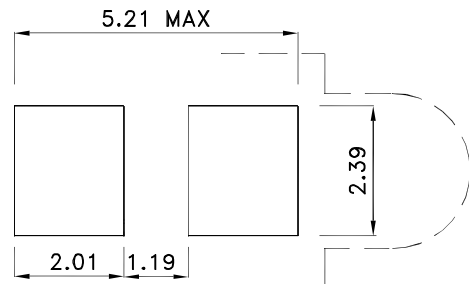

Tape and Reel Specifications

Tape Dimension (Units : mm)

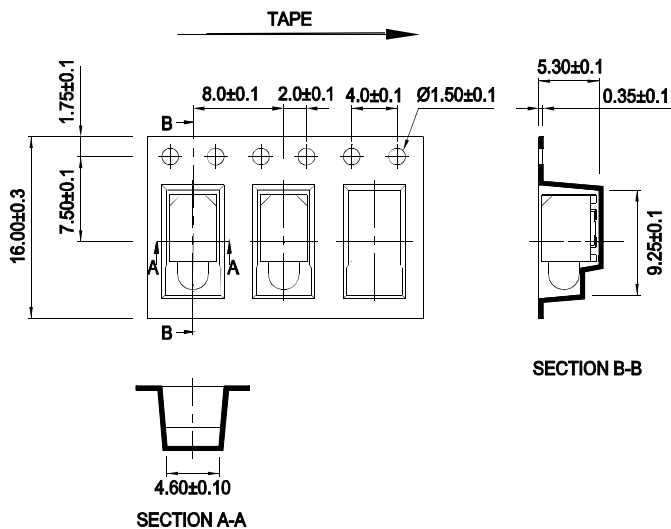

Reel Dimension Units: mm [inches] 13" Reel

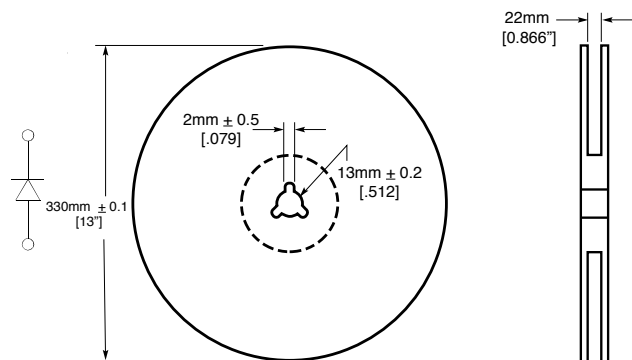

Packing Specifications

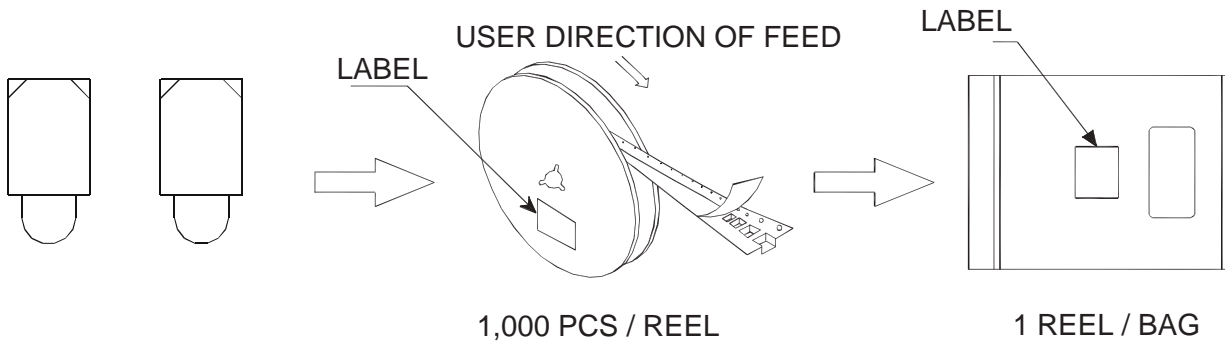

Terms and Conditions

1. The information included in this document reflects representative usage scenarios and is intended for technical reference only.
2. The part number, type, and specifications mentioned in this document are subject to future change and improvement without notice. Before production usage customer should refer to the latest datasheet for the updated specifications.
3. When using the products referenced in this document, please make sure the product is being operated within the environmental and electrical limits specified in the datasheet. If customer usage exceeds the specified limits, VCC will not be responsible for any subsequent issues.
4. The information in this document applies to typical usage in consumer electronics applications. If customer's application has special reliability requirements or have life-threatening liabilities, such as automotive or medical usage, please consult with VCC representative for further assistance.
5. The contents and information of this document may not be reproduced or re-transmitted without permission by VCC.

Application Notes

Introduction

6300T series are surface-mounted right-angle light-emitting diode (LED) circuit-board indicators. It offers the convenience of surface-mount production while offering the right-angle height profile of circuit-board indicator lamps. The part is suitable for automated SMT and lead-free reflow soldering production. The clear silicone lens extends out to provide broad viewing angles. When installed on customer's circuit board, it can provide illuminated indication or backlight panel indicators.

Transport and Storage

Surface mount devices (SMD) are moisture sensitive components. Atmospheric moisture will seep into the component package, so when placed on the circuit board for 160-200°C reflow soldering, the high temperatures cause the absorbed moisture to vaporize and rapidly expand, creating vapor pressure that could damage the LED component by causing cracks in the lens, delamination of the chip and wire bonds, or other reliability issues.

1. Transportation

The product is packed in anti-static, moisture-proof mylar bags. The package should be carefully handled to avoid external pressure and accidental puncture during transport. Proper anti-static practices should be in place. If package leakage or damage is found before opening, suggest customer take the damaged package off-line for additional testing and bake to dry before use.

2. Storage Conditions (Before Opening)

To prevent moisture-absorption reliability issues, the parts must be properly stored. Suggest do not open the moisture-proof package until immediately before usage (except for sample inspection purposes). The opened package must be re-sealed with fresh desiccant and humidity indicator and stored in a dry box (<30/60% RH).

3. Humidity Control (After Opening)

After opening the moisture-proof packaging, immediately check the humidity indicator card contained inside to confirm the parts have been exposed to excess moisture. The production environment should follow IPC/JEDEC J-STD-020 standards for temperature, humidity, and exposure time. SMD environmental exposure time accumulates as long as the parts are outside the packaging, unless they are being baked dry.

Table 1: IPC/JEDEC J-STD-020 Moisture Sensitivity Levels (MSL)

MSL	Allowed Exposure After Opening	
	Time	Conditions
LEVEL 1	No Limit	≤ 30°C/85%RH
LEVEL 2	1 Year	≤ 30°C/60%RH
LEVEL 2a	4 Weeks	≤ 30°C/60%RH
LEVEL 3	168 Hours	≤ 30°C/60%RH
LEVEL 4	72 Hours	≤ 30°C/60%RH
LEVEL 5	48 Hours	≤ 30°C/60%RH
LEVEL 5a	24 Hours	≤ 30°C/60%RH
LEVEL 6	Immediately upon open	≤ 30°C/60%RH

4. Storage of Unused And Remaining Parts

If the full reel was not consumed during production, the production environment was within limits (<30/60% RH), and the exposure time did not exceed the limits in Table 1, then the remaining parts may be stored as below:

- Re-sealed with desiccant.
- Stored within a dry box (5% RH). The dry box storage time would not count against the total exposure time. When the stored parts are taken out, the exposure time is accumulated from the previous production run.

Application Notes

5. Humidity Control Of PCB-Mounted Parts

If the moisture-sensitive SMD parts will not undergo further reflow or other high-temperature processes, then no special treatment is required. However, if the PCB assembly requires further reflow or other high-temperature process, including rework, then the mounted SMD's exposure time should continue to accumulate against the MSL limit, unless the board is kept in a dry environment (<5% RH). If the exposure time exceeds the MSL limit, the board and part must be baked dry to reset the exposure time before undergoing further reflow.

Installation and Usage

If the part's silicone lens extends beyond the board's edge after installation, proper protection should be made (such as covers) to prevent accidental impact or stress on the exposed lens that would cause damage or detachment. The silicone lens may withstand up to 1.5-newton in shear force when properly mounted. If external protection is not available, strongly suggest following these handling procedures to prevent damage:

1. When the PCB assembly is handled or transported after reflow soldering, care must be taken to prevent accidental contact or impact on the exposed silicone lens.
2. When the PCB assembly is installed into the casing or panel, care must be taken to maintain sufficient clearance for the lens.
3. Do not subject the silicone lens to outside impact or friction.

Cleaning

1. Do not use unknown chemicals or acidic solvents to clean the part. Please check to insure the cleaning solvent will not corrode epoxy resin, silicone resin, silver plating, and other component materials before using.
2. VCC suggests ethanol as a safe solvent for use with the surface mount devices. Softly wipe away any surface particles, avoiding excessive force scratching the surface or damaging the structures. Then place down and allow to naturally dry under room temperature conditions before further use. Do not soak the component in the solvent.

Compliances and Approvals

