

AC Filter 2-Stage, Broad Band Attenuation



Quick connect terminals 6.3x0.8 mm
 Case MB



Quick connect terminals 6.3x0.8 mm
 Case MF



Quick connect terminals 6.3x0.8 mm
 Case 09

See below:
[Approvals and Compliances](#)

Description

- Line filter in standard and medical version
- 2 positions
- 3 Designs:

Unique Selling Proposition

- Broad band attenuation
- 3 Filter designs for various applications
- Completely closed steel housing
- Wide temperature range

Characteristics

- Designed for current applications of 1 - 36 A
- Protection against interference voltage from the mains
 Possible interferences generated in the equipment are strongly attenuated
- Especially designed for industrial applications such as: Frequency Converters, Stepper Motor Drives, UPS-Systems, Inverters
- Suitable for use in equipment according to IEC/UL 60950
 Suitable for use in medical equipment according to IEC/UL 60601-1

Other versions on request

- Version with wire connection
- Version with varistor for overvoltage protection

References

Alternative: Standard version

Weblinks

[pdf data sheet](#), [html datasheet](#), [General Product Information](#), [Distributor-Stock-Check](#), [Detailed request for product](#), [Microsite](#)

Technical Data

Ratings IEC	1 - 36A @ Ta 40 °C / 250VAC; 50Hz
Ratings UL/CSA	1 - 30A @ Ta 40 °C / 125/250VAC; 60Hz
Leakage Current	standard < 0.5 mA (250 V / 60Hz) medical (M5) < 5 µA resp. (M80) < 80 µA (250 V / 60 Hz)
Dielectric Strength	1.7kVDC between L-N 2.75kVDC between L/N-PE Test voltage (2 sec)
Allowable Operation Temperature	-40°C to 100°C
Climatic Category	40/100/21 acc. to IEC 60068-1
IP-Protection	from rear-side IP20 IEC 60529
Protection Class	Suitable for appliances with protection class I acc. to IEC 61140
Terminal	Quick connect terminal 6.3 x 0.8 mm Bolt and nut M4
Material: Housing	Metal

Line Filter	Standard and Medical Version, IEC 60939, UL 1283, CSA C22.2 no. 8 Technical Details
MTBF	> 200'000h acc. to MIL-HB-217 F

Approvals and Compliances



Detailed information on product approvals, code requirements, usage instructions and detailed test conditions can be looked up in [Details about Approvals](#)

SCHURTER products are designed for use in industrial environments. They have approvals from independent testing bodies according to national and international standards. Products with specific characteristics and requirements such as required in the automotive sector according to IATF 16949, medical technology according to ISO 13485 or in the aerospace industry can be offered exclusively with customer-specific, individual agreements by SCHURTER.

Approvals







The approval mark is used by the testing authorities to certify compliance with the safety requirements placed on electronic products.

Approval Reference Type: FMBB NEO

Approval Logo	Certificates	Certification Body	Description
	VDE Approvals	VDE	Certificate Number: 40030410
	UL Approvals	UL	UL File Number: E72928



Product standards

Product standards that are referenced

Organization	Design	Standard	Description
	Designed according to	IEC 60320-1	Appliance couplers for household and similar general purposes
	Designed according to	IEC 60939	Passive filters for suppressing electromagnetic interference
	Designed according to	IEC 60127-6	Miniature fuses. Part 6. Fuse-holders for miniature fuse-links
	Designed according to	UL 498	Standard for Attachment Plugs and Receptacles
	Designed according to	UL 1283	Electromagnetic interference filters
	Designed according to	CSA C22.2 no. 42	General Use Receptacles, Attachment Plugs, and Similar Wiring Devices
	Designed according to	CSA C22.2 no. 8	Electromagnetic interference (EMI) filters





Application standards

Application standards where the product can be used

Organization	Design	Standard	Description
	Designed for applications acc.	IEC/UL 60950	IEC 60950-1 includes the basic requirements for the safety of information technology equipment.
	Designed for applications acc.	IEC 60601-1	Medical electrical equipment - Part 1: General requirements for basic safety and essential performance

Compliances

The product complies with following Guide Lines

Identification	Details	Initiator	Description
	CE declaration of conformity	SCHURTER AG	The CE marking declares that the product complies with the applicable requirements laid down in the harmonisation of Community legislation on its affixing in accordance with EU Regulation 765/2008.
	RoHS	SCHURTER AG	Directive RoHS 2011/65/EU, Amendment (EU) 2015/863
	China RoHS	SCHURTER AG	The law SJ / T 11363-2006 (China RoHS) has been in force since 1 March 2007. It is similar to the EU directive RoHS.
	REACH	SCHURTER AG	On 1 June 2007, Regulation (EC) No 1907/2006 on the Registration, Evaluation, Authorization and Restriction of Chemicals 1 (abbreviated as "REACH") entered into force.
	Medical Technology	SCHURTER AG	Suitable for use in medical equipment according to IEC/UL 60601-1

Dimension [mm]

Case 09 with quick connect terminals

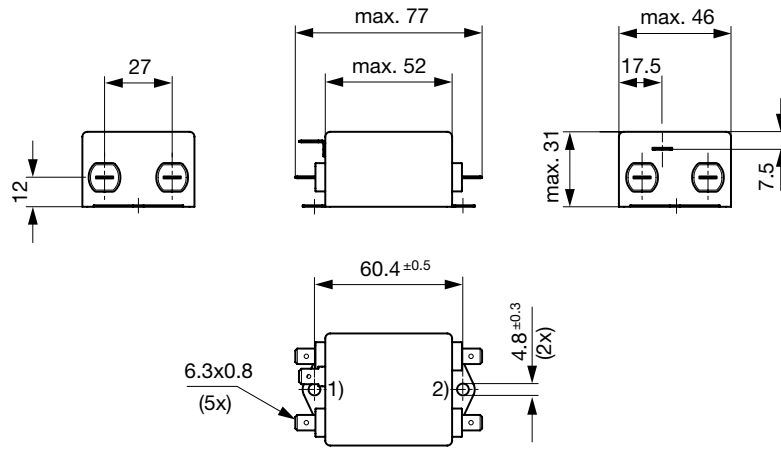

- 1) Line
- 2) Load

Case MB with quick connect terminals

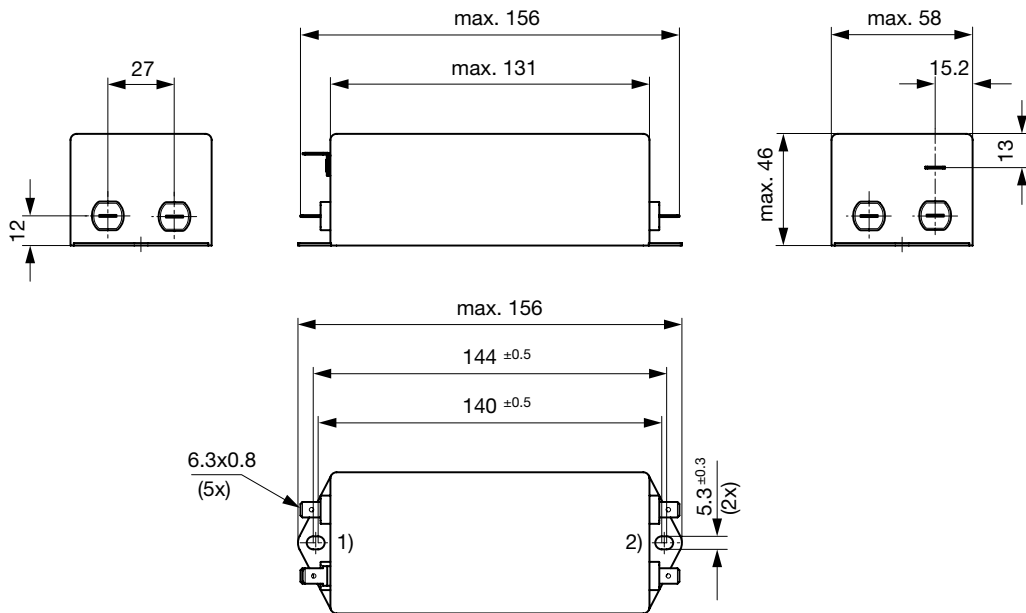

- 1) Line
- 2) Load

Case MB with bolt and nut M4

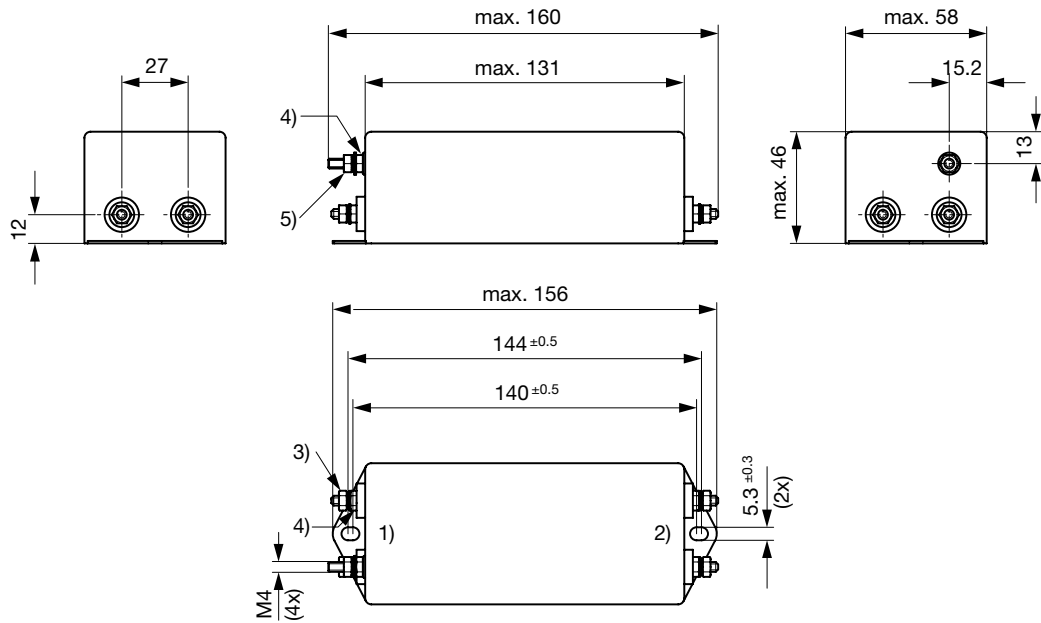

- 1) Line
- 2) Load
- 3) Nut torque 0.8...1 Nm, keep lock-nut fastened
- 4) Lock-nut do not unscrew
- 5) PE: M4x16, 1.2...1.5 Nm, keep lock-nut fastened

Case MC with quick connect terminals

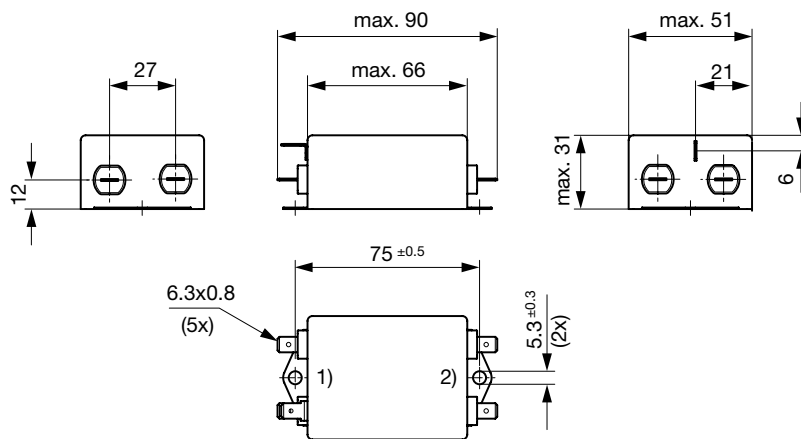

- 1) Line
- 2) Load

Case MD with quick connect terminals

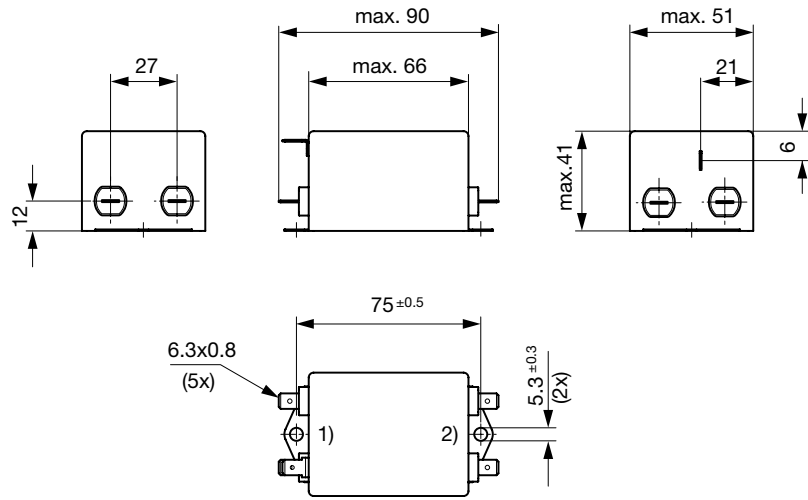

- 1) Line
- 2) Load

Case ME with quick connect terminals

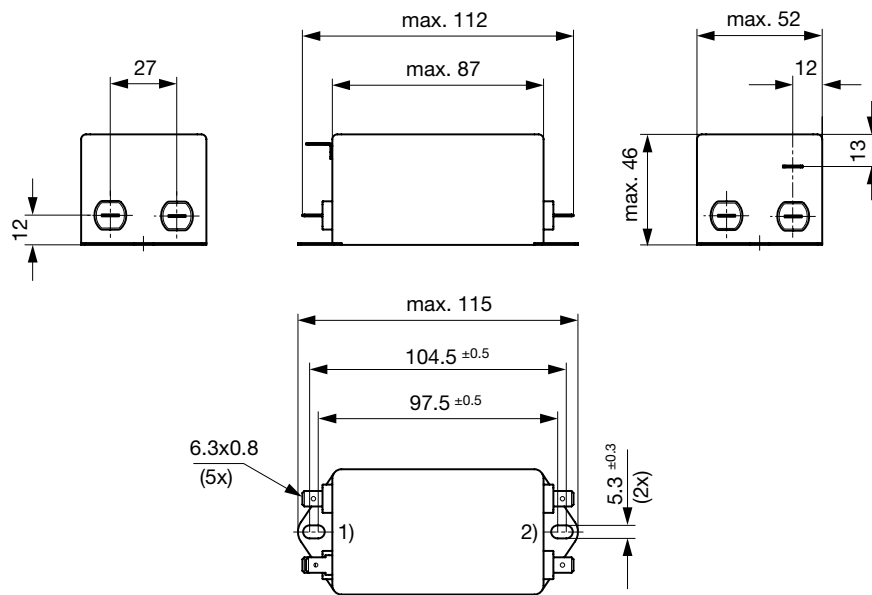

- 1) Line
- 2) Load

Case MF with quick connect terminals

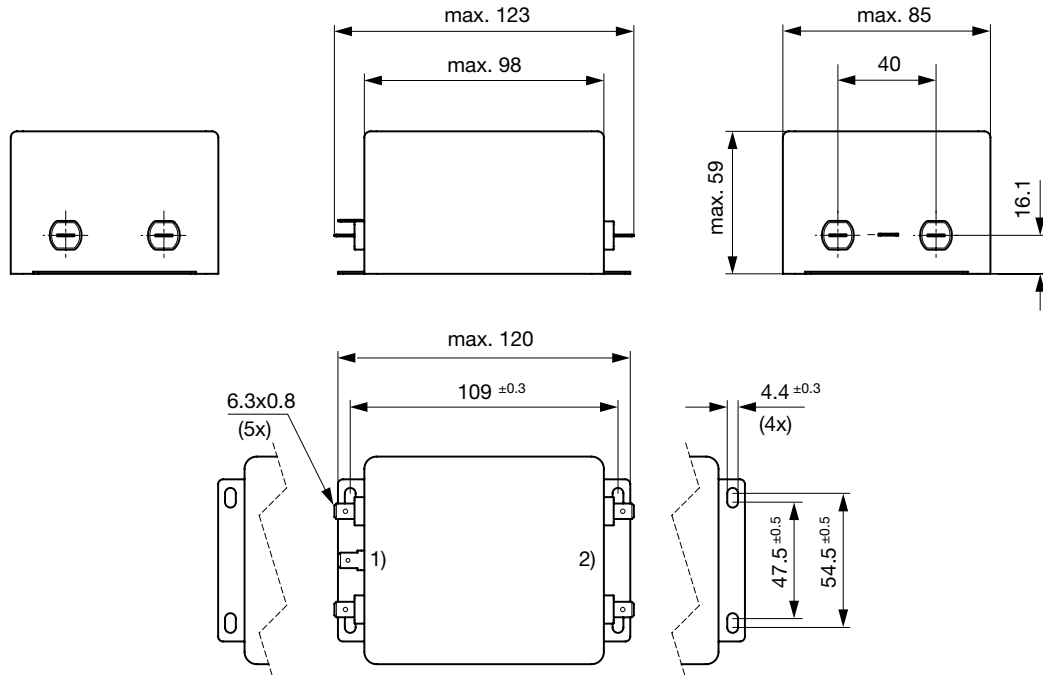

- 1) Line
- 2) Load

Case MF with bolt and nut M4

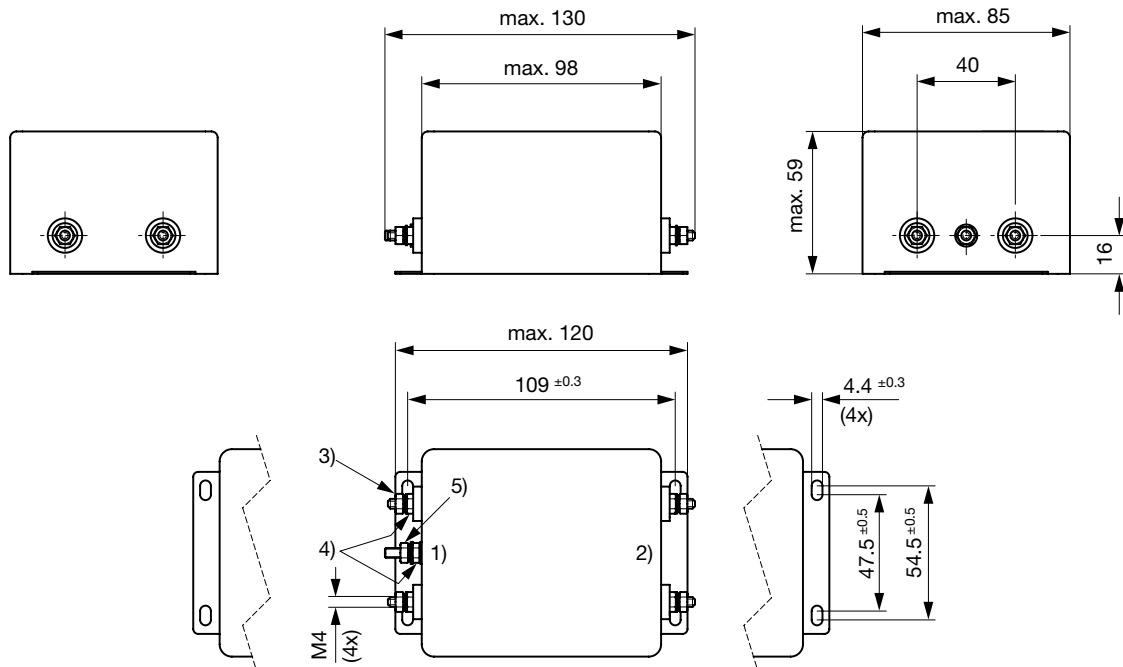

- 1) Line
- 2) Load
- 3) Nut torque 0.8...1 Nm, keep lock-nut fastened
- 4) Lock-nut do not unscrew
- 5) PE: M4x16, 1.2...1.5 Nm, keep lock-nut fastened

Case with wire leads

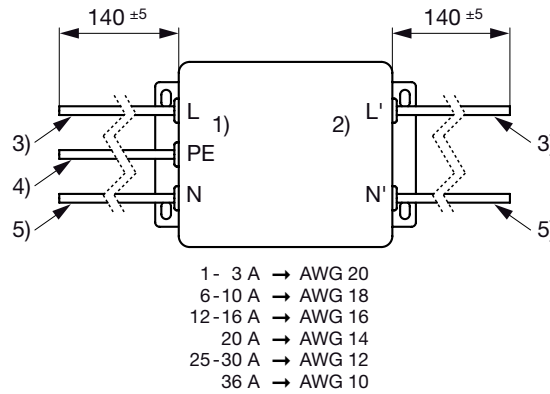

- 1) Line
- 2) Load
- 3) Brown
- 4) Yellow-Green
- 5) Blue

Diagrams

Design C and D

Design F

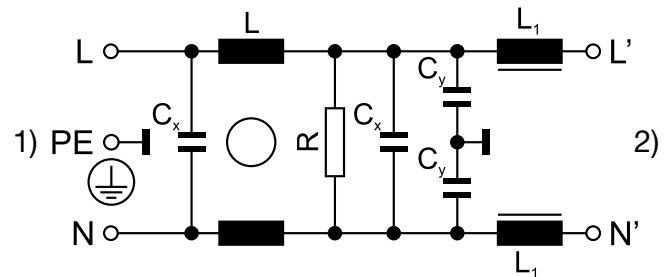
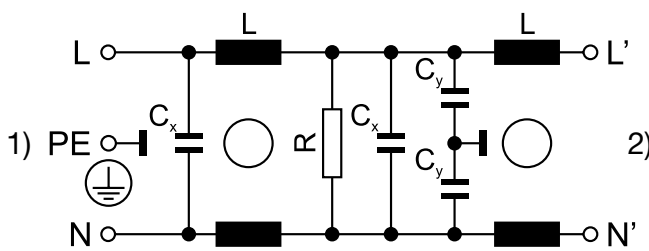

- 1) Line, 2) Load
- Bleeding resistor $R = 1 \text{ M}\Omega$
- Medical (M5) without C_y

Attenuation Loss 0.1/100Ω differential mode 100/0.1Ω differential mode - - - - 50Ω differential mode ____ 50Ω common mode

Standard version

1 A / Design C

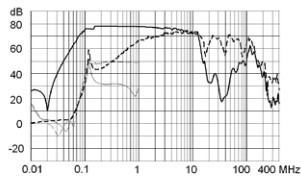

3 A / Design C

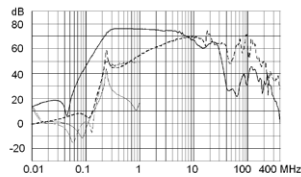

6 A / Design C

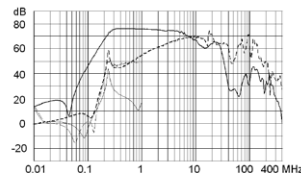

10 A / Design C

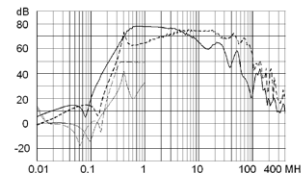

12 A / Design C

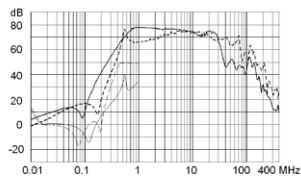

16 A / Design C

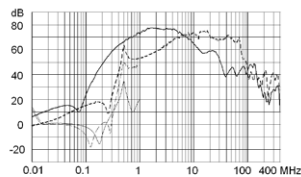

20 A / Design C

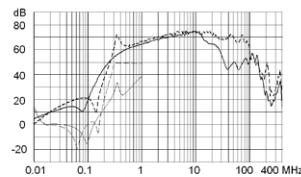

30 A / Design C

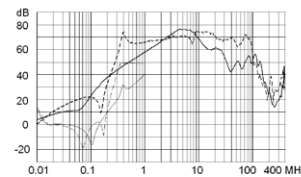

1 A / Design D

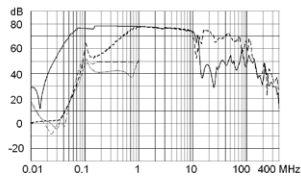

3 A / Design D

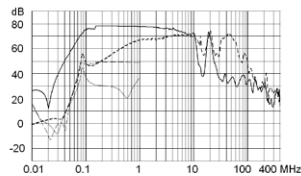

6 A / Design D

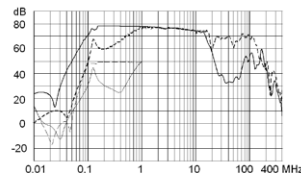

10 A / Design D

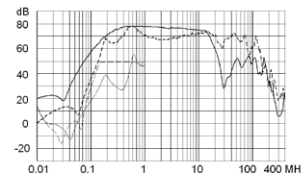

12 A / Design D

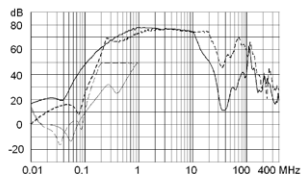

16 A / Design D

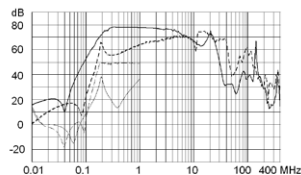

25 A / Design D

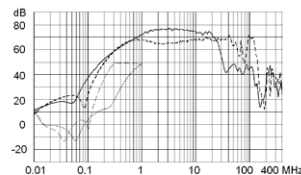

36 A / Design D

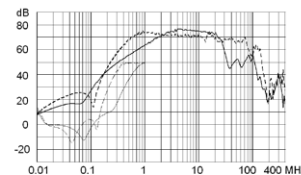

1 A / Design F

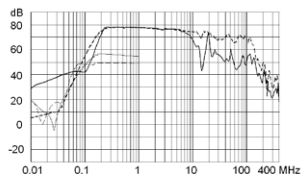

3 A / Design F

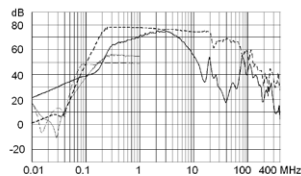

6 A / Design F

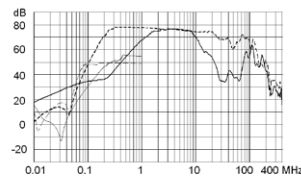

10 A / Design F

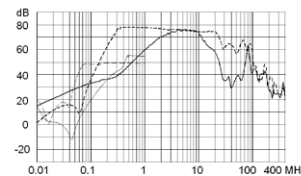

12 A / Design F

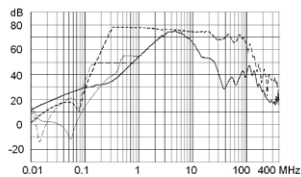

16 A / Design F

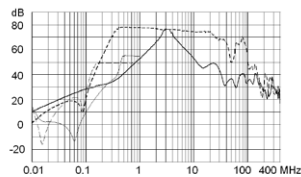

Medical version (M5)

1 A / Design C

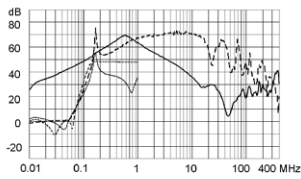

3 A / Design C

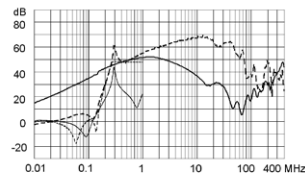

6 A / Design C

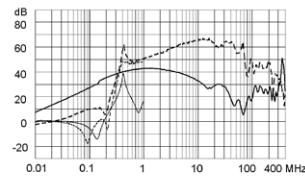

10 A / Design C

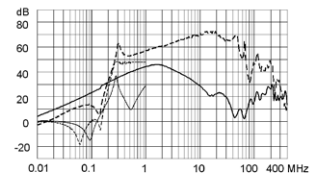

12 A / Design C

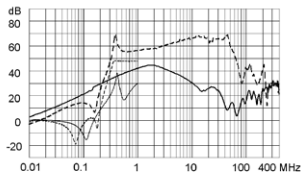

16 A / Design C

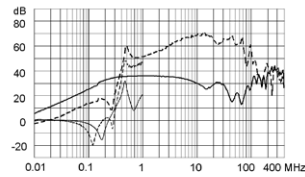

20 A / Design C

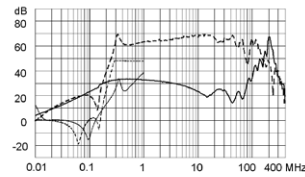

30 A / Design C

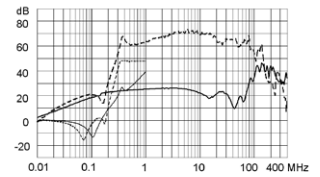

1 A / Design D

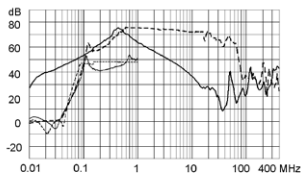

3 A / Design D

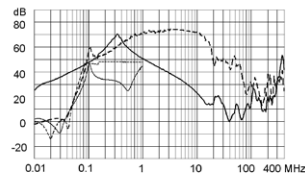

6 A / Design D

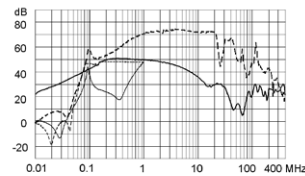

10 A / Design D

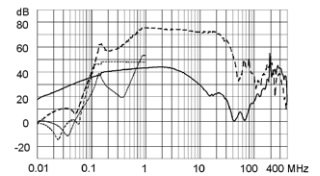

12 A / Design D

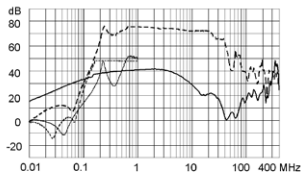

16 A / Design D

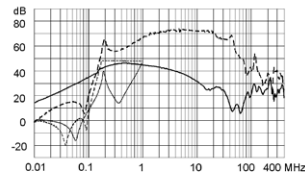

25 A / Design D

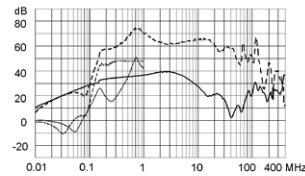

36 A / Design D

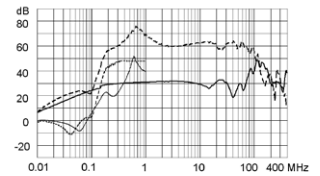

1 A / Design F

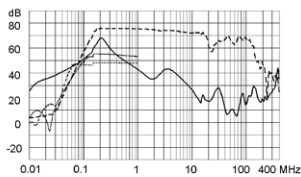

3 A / Design F

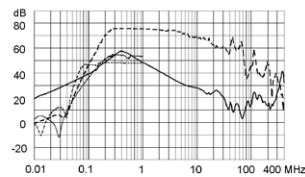

6 A / Design F

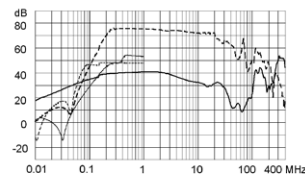

10 A / Design F

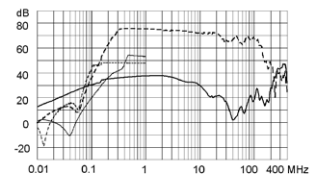

12 A / Design F

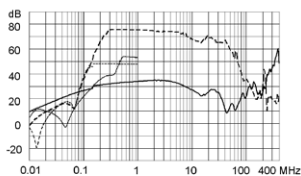

16 A / Design F

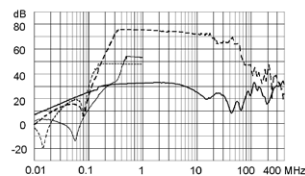

All Variants

Rated current	Filter-Type	Terminal	Design	L	L1	Cx	Cy	Ri	Power Loss	Weight	Housings	Packaging	Order Number
[A]				[mH]	[mH]	[µF]	[nF]	[mΩ]	[W]	[g]		[ST]	
1	Standard	Quick connect terminal 6.3 x 0.8 mm	C	12	-	0.22	4.7	945	1.9	125g	09	15	5500.2600.01
3	Standard	Quick connect terminal 6.3 x 0.8 mm	C	2.5	-	0.22	4.7	120	2.2	130g	09	15	5500.2601.01
6	Standard	Quick connect terminal 6.3 x 0.8 mm	C	0.97	-	0.22	4.7	26.2	1.9	130g	09	15	5500.2602.01
10	Standard	Quick connect terminal 6.3 x 0.8 mm	C	0.8	-	0.47	4.7	12.9	2.6	200g	MC	10	5500.2603.01
12	Standard	Quick connect terminal 6.3 x 0.8 mm	C	0.58	-	0.47	4.7	10.1	2.9	200g	MC	10	5500.2604.01
16	Standard	Quick connect terminal 6.3 x 0.8 mm	C	0.65	-	0.33	4.7	8	4.1	265g	MD	10	5500.2605.01
20	Standard	Quick connect terminal 6.3 x 0.8 mm	C	0.6	-	1	4.7	4.6	3.7	390g	ME	5	5500.2606.01
30	Standard	Bolt and nut M4	C	0.6	-	1	10	2.5	4.5	855g	MF	3	5500.2607.03
1	Standard	Quick connect terminal 6.3 x 0.8 mm	D	22	-	0.33	4.7	1320	2.7	165g	MC	10	5500.2610.01
3	Standard	Quick connect terminal 6.3 x 0.8 mm	D	9.8	-	0.47	4.7	226	4.1	225g	MD	10	5500.2611.01
6	Standard	Quick connect terminal 6.3 x 0.8 mm	D	7.8	-	1	4.7	55.4	4	350g	ME	5	5500.2612.01
10	Standard	Quick connect terminal 6.3 x 0.8 mm	D	4.5	-	1	4.7	23.6	4.7	625g	MB	4	5500.2613.01
12	Standard	Quick connect terminal 6.3 x 0.8 mm	D	3.25	-	1	4.7	16	4.6	630g	MB	4	5500.2614.01
16	Standard	Quick connect terminal 6.3 x 0.8 mm	D	2.8	-	1	4.7	10.9	5.6	826g	MF	3	5500.2615.01
25	Standard	Bolt and nut M4	D	2.0	-	2.2	4.7	4.8	6	830g	MB	4	5500.2616.03
36	Standard	Bolt and nut M4	D	1.23	-	2.2	4.7	3.3	8.5	810g	MB	4	5500.2617.03
1	Standard	Quick connect terminal 6.3 x 0.8 mm	F	22	0.49	0.33	4.7	1200	2.4	180g	MC	10	5500.2620.01
3	Standard	Quick connect terminal 6.3 x 0.8 mm	F	9.8	0.16	0.47	4.7	194	3.5	240g	MD	10	5500.2621.01
6	Standard	Quick connect terminal 6.3 x 0.8 mm	F	7.8	0.11	1	4.7	60	4.3	400g	ME	5	5500.2622.01
10	Standard	Quick connect terminal 6.3 x 0.8 mm	F	4.5	0.06	1	4.7	21	4.2	645g	MB	4	5500.2623.01
12	Standard	Quick connect terminal 6.3 x 0.8 mm	F	3.25	0.05	1	4.7	14.6	4.2	695g	MB	4	5500.2624.01
16	Standard	Quick connect terminal 6.3 x 0.8 mm	F	2.8	0.043	1	4.7	13.7	7	950g	MF	3	5500.2625.01
1	Medical (M5)	Quick connect terminal 6.3 x 0.8 mm	C	12	-	0.22	-	945	1.9	125g	09	15	5500.2600.04
3	Medical (M5)	Quick connect terminal 6.3 x 0.8 mm	C	2.5	-	0.22	-	120	2.2	130g	09	15	5500.2601.04
6	Medical (M5)	Quick connect terminal 6.3 x 0.8 mm	C	0.97	-	0.22	-	26.2	1.9	130g	09	15	5500.2602.04
10	Medical (M5)	Quick connect terminal 6.3 x 0.8 mm	C	0.8	-	0.47	-	12.9	2.6	200g	MC	10	5500.2603.04
12	Medical (M5)	Quick connect terminal 6.3 x 0.8 mm	C	0.58	-	0.47	-	10.1	2.9	200g	MC	10	5500.2604.04
16	Medical (M5)	Quick connect terminal 6.3 x 0.8 mm	C	0.65	-	0.33	-	8	4.1	265g	MD	10	5500.2605.04
20	Medical (M5)	Quick connect terminal 6.3 x 0.8 mm	C	0.6	-	1	-	4.6	3.7	390g	ME	5	5500.2606.04
30	Medical (M5)	Bolt and nut M4	C	0.6	-	1	-	2.5	4.5	855g	MF	3	5500.2607.06
1	Medical (M5)	Quick connect terminal 6.3 x 0.8 mm	D	22	-	0.33	-	1320	2.7	165g	MC	10	5500.2610.04
3	Medical (M5)	Quick connect terminal 6.3 x 0.8 mm	D	9.8	-	0.47	-	226	4.1	225g	MD	10	5500.2611.04
6	Medical (M5)	Quick connect terminal 6.3 x 0.8 mm	D	7.8	-	1	-	55.4	4	350g	ME	5	5500.2612.04
10	Medical (M5)	Quick connect terminal 6.3 x 0.8 mm	D	4.5	-	1	-	23.6	4.7	625g	MB	4	5500.2613.04
12	Medical (M5)	Quick connect terminal 6.3 x 0.8 mm	D	3.25	-	1	-	16	4.6	630g	MB	4	5500.2614.04
16	Medical (M5)	Quick connect terminal 6.3 x 0.8 mm	D	2.8	-	1	-	10.9	5.6	826g	MF	3	5500.2615.04
25	Medical (M5)	Bolt and nut M4	D	2.0	-	2.2	-	4.8	6	830g	MB	4	5500.2616.06
36	Medical (M5)	Bolt and nut M4	D	1.23	-	2.2	-	3.3	8.5	810g	MB	4	5500.2617.06
1	Medical (M5)	Quick connect terminal 6.3 x 0.8 mm	F	22	0.49	0.33	-	1200	2.4	180g	MC	10	5500.2620.04
3	Medical (M5)	Quick connect terminal 6.3 x 0.8 mm	F	9.8	0.16	0.47	-	194	3.5	240g	MD	10	5500.2621.04
6	Medical (M5)	Quick connect terminal 6.3 x 0.8 mm	F	7.8	0.11	1	-	60	4.3	400g	ME	5	5500.2622.04
10	Medical (M5)	Quick connect terminal 6.3 x 0.8 mm	F	4.5	0.06	1	-	21	4.2	645g	MB	4	5500.2623.04
12	Medical (M5)	Quick connect terminal 6.3 x 0.8 mm	F	3.25	0.05	1	-	14.6	4.2	695g	MB	4	5500.2624.04
16	Medical (M5)	Quick connect terminal 6.3 x 0.8 mm	F	2.8	0.043	1	-	13.7	7	950g	MF	3	5500.2625.04
1	Medical (M80)	Quick connect terminal 6.3 x 0.8 mm	C	12	-	0.22	0.47	945	1.9	125g	09	15	5500.2600.07
3	Medical (M80)	Quick connect terminal 6.3 x 0.8 mm	C	2.5	-	0.22	0.47	120	2.2	130g	09	15	5500.2601.07
6	Medical (M80)	Quick connect terminal 6.3 x 0.8 mm	C	0.97	-	0.22	0.47	26.2	1.9	130g	09	15	5500.2602.07
10	Medical (M80)	Quick connect terminal 6.3 x 0.8 mm	C	0.8	-	0.47	0.47	12.9	2.6	200g	MC	10	5500.2603.07
12	Medical (M80)	Quick connect terminal 6.3 x 0.8 mm	C	0.58	-	0.47	0.47	10.1	2.9	200g	MC	10	5500.2604.07
16	Medical (M80)	Quick connect terminal 6.3 x 0.8 mm	C	0.65	-	0.33	0.47	8	4.1	265g	MD	10	5500.2605.07
20	Medical (M80)	Quick connect terminal 6.3 x 0.8 mm	C	0.6	-	1	0.47	4.6	3.7	390g	ME	5	5500.2606.07
30	Medical (M80)	Bolt and nut M4	C	0.6	-	1	0.47	2.5	4.5	855g	MF	3	5500.2607.09
1	Medical (M80)	Quick connect terminal 6.3 x 0.8 mm	D	22	-	0.33	0.47	1320	2.7	165g	MC	10	5500.2610.07

Rated current	Filter-Type	Terminal	Design	L	L1	Cx	Cy	Ri	Power Loss	Weight	Housings	Packaging	Order Number
[A]				[mH]	[mH]	[µF]	[nF]	[mΩ]	[W]	[g]		[ST]	
3	Medical (M80)	Quick connect terminal 6.3 x 0.8 mm	D	9.8	-	0.47	0.47	226	4.1	225 g	MD	10	5500.2611.07
6	Medical (M80)	Quick connect terminal 6.3 x 0.8 mm	D	7.8	-	1	0.47	55.4	4	350 g	ME	5	5500.2612.07
10	Medical (M80)	Quick connect terminal 6.3 x 0.8 mm	D	4.5	-	1	0.47	23.6	4.7	625 g	MB	4	5500.2613.07
12	Medical (M80)	Quick connect terminal 6.3 x 0.8 mm	D	3.25	-	1	0.47	16	4.6	630 g	MB	4	5500.2614.07
16	Medical (M80)	Quick connect terminal 6.3 x 0.8 mm	D	2.8	-	1	0.47	10.9	5.6	826 g	MF	3	5500.2615.07
25	Medical (M80)	Bolt and nut M4	D	2.0	-	2.2	0.47	4.8	6	830 g	MB	4	5500.2616.09
36	Medical (M80)	Bolt and nut M4	D	1.23	-	2.2	0.47	3.3	8.5	810 g	MB	4	5500.2617.09
1	Medical (M80)	Quick connect terminal 6.3 x 0.8 mm	F	22	0.49	0.33	0.47	1200	2.4	180 g	MC	10	5500.2620.07
3	Medical (M80)	Quick connect terminal 6.3 x 0.8 mm	F	9.8	0.16	0.47	0.47	194	3.5	240 g	MD	10	5500.2621.07
6	Medical (M80)	Quick connect terminal 6.3 x 0.8 mm	F	7.8	0.11	1	0.47	60	4.3	400 g	ME	5	5500.2622.07
10	Medical (M80)	Quick connect terminal 6.3 x 0.8 mm	F	4.5	0.06	1	0.47	21	4.2	645 g	MB	4	5500.2623.07
12	Medical (M80)	Quick connect terminal 6.3 x 0.8 mm	F	3.25	0.05	1	0.47	14.6	4.2	695 g	MB	4	5500.2624.07
16	Medical (M80)	Quick connect terminal 6.3 x 0.8 mm	F	2.8	0.043	1	0.47	13.7	7	950 g	MF	3	5500.2625.07

Most Popular.

Availability for all products can be searched real-time: <https://www.schurter.com/en/Stock-Check/Stock-Check-SCHURTER>

- Design
- C) high symmetrical and asymmetrical noise attenuation
 - D) Excellent high frequency noise attenuation
 - F) Excellent low frequency noise attenuation