

IEC Appliance Inlet C14 with Filter



Screw-on mounting
from front side

Snap-in version
from front side



See below:
[Approvals and Compliances](#)

Description

- Panel mount :
Snap-in or screw-on mounting from front side
- 2 Functions :
Appliance Inlet Protection class I , Line filter in standard and medical version
- Quick connect terminals 6.3 x 0.8 mm

Unique Selling Proposition

- Ultra-compact design
- High quality filter case made of stainless steel
- Highly resistant since potted filter
- Various filter variants

Characteristics

- All single elements are already wired
- For applications according IEC/UL 62368-1 we recommend variants with bleed resistor
Suitable for use in medical equipment according to IEC/UL 60601-1

Other versions on request

- Capacity CX 100 nF
- Medical Version (M80)

References

Alternative: version without line filter [6100-3](#); [6100-4](#)
 We recommend for new applications the type [5120](#)

Weblinks

[pdf data sheet](#), [html datasheet](#), [General Product Information](#), [Approvals](#), [Distributor-Stock-Check](#), [Accessories](#), [Detailed request for product](#)

Technical Data

| | |
|---------------------------------|---|
| Ratings IEC | 1 - 10A @ Ta 40 °C / 250VAC; 50Hz |
| Ratings UL/CSA | 1 - 15A @ Ta 40 °C / 250VAC; 60Hz |
| Leakage Current | standard < 0.5mA (250V / 60Hz) medical < 5 µA (250 V / 60 Hz) |
| Dielectric Strength | > 1.7kVDC between L-N > 2.7kVDC between L/N-PE Test voltage (2sec) |
| Allowable Operation Temperature | -25 °C to 85 °C |
| Climatic Category | 25/085/21 acc. to IEC 60068-1 |
| IP-Protection | from front side IP40 acc. to IEC 60529 |
| Protection Class | Suitable for appliances with protection class I acc. to IEC 61140 |
| Terminal | Quick connect terminals 6.3 x 0.8 mm |
| Panel Thickness S | Screw: max 5 mm Mounting screw torque max 0.5Nm Snap-in: 0.8mm to 3mm |
| Material: Housing | Thermoplastic, black, UL 94V-0 |

| | |
|-------------------------|--|
| Appliance inlet/-outlet | C14 acc. to IEC 60320-1, UL 498, CSA C22.2 no. 42 (for cold conditions) pin-temperature 70 °C, 10A, Protection Class I |
| Line Filter | Standard and Medical Version, IEC 60939, UL 1283, CSA C22.2 no. 8 Technical Details |
| MTBF | > 3'100'000h acc. to MIL-HB-217 F |

Approvals and Compliances



Detailed information on product approvals, code requirements, usage instructions and detailed test conditions can be looked up in [Details about Approvals](#)

SCHURTER products are designed for use in industrial environments. They have approvals from independent testing bodies according to national and international standards. Products with specific characteristics and requirements such as required in the automotive sector according to IATF 16949, medical technology according to ISO 13485 or in the aerospace industry can be offered exclusively with customer-specific, individual agreements by SCHURTER.

Approvals







The approval mark is used by the testing authorities to certify compliance with the safety requirements placed on electronic products.

Approval Reference Type: 5110

| Approval Logo | Certificates | Certification Body | Description |
|--|---------------|--------------------|--|
|  | VDE Approvals | VDE | Certificate Number: 40035745 |
|  | UL Approvals | UL | UL File Number: E72928 |
|  | CQC Approvals | CQC | CQC Certificate Number: CQC18001207813 |



Product standards

Product standards that are referenced

| Organization | Design | Standard | Description |
|--|-----------------------|------------------|---|
|  | Designed according to | IEC 60320-1 | Appliance couplers for household and similar general purposes |
|  | Designed according to | IEC 60939 | Passive filters for suppressing electromagnetic interference |
|  | Designed according to | IEC 61058-1 | Switches for appliances. Part 1. General requirements |
|  | Designed according to | UL 498 | Standard for Attachment Plugs and Receptacles |
|  | Designed according to | UL 1283 | Electromagnetic interference filters |
|  | Designed according to | CSA C22.2 no. 42 | General Use Receptacles, Attachment Plugs, and Similar Wiring Devices |
|  | Designed according to | CSA C22.2 no. 8 | Electromagnetic interference (EMI) filters |





Application standards

Application standards where the product can be used

| Organization | Design | Standard | Description |
|--|--------------------------------|----------------|--|
|  | Designed for applications acc. | IEC/UL 62368-1 | IEC 62368-1 includes the basic requirements for safety of audio, video, information technology and office equipment. |
|  | Designed for applications acc. | IEC 60601-1 | Medical electrical equipment - Part 1: General requirements for basic safety and essential performance |

Compliances

The product complies with following Guide Lines

| Identification | Details | Initiator | Description |
|--|------------------------------|-------------|---|
|  | CE declaration of conformity | SCHURTER AG | The CE marking declares that the product complies with the applicable requirements laid down in the harmonisation of Community legislation on its affixing in accordance with EU Regulation 765/2008. |
|  | RoHS | SCHURTER AG | Directive RoHS 2011/65/EU, Amendment (EU) 2015/863 |
|  | China RoHS | SCHURTER AG | The law SJ / T 11363-2006 (China RoHS) has been in force since 1 March 2007. It is similar to the EU directive RoHS. |
|  | REACH | SCHURTER AG | On 1 June 2007, Regulation (EC) No 1907/2006 on the Registration, Evaluation, Authorization and Restriction of Chemicals 1 (abbreviated as "REACH") entered into force. |
|  | Medical Equipment | SCHURTER AG | Suitable for use in medical equipment according to IEC/UL 60601-1 |

Dimension [mm]

Screw-on mounting

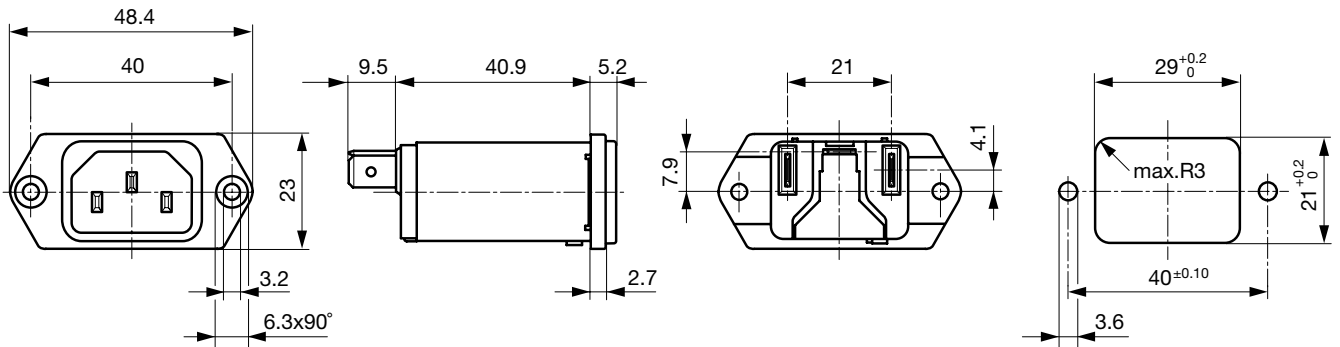

Snap-in mounting

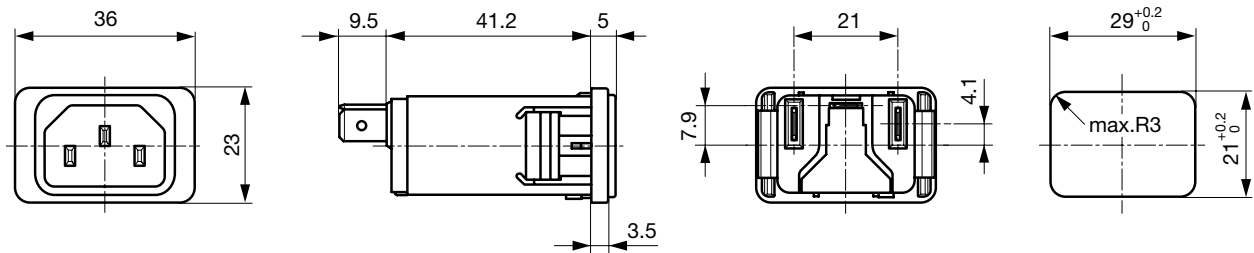

Technical Data of Filter-Components

| Rated Current [A] | Filter-Type | Inductances L [mH] | Capacitance CX [nF] | Capacitance CY [nF] | R [MΩ] |
|-------------------|------------------------------|--------------------|---------------------|---------------------|--------|
| 1 | Standard version | 2 x 11 | 47 | 2.2 | - |
| 2 | Standard version | 2 x 4 | 47 | 2.2 | - |
| 3 | Standard version | 2 x 2.5 | 47 | 2.2 | - |
| 4 | Standard version | 2 x 1.6 | 47 | 2.2 | - |
| 6 | Standard version | 2 x 0.7 | 47 | 2.2 | - |
| 8 | Standard version | 2 x 0.6 | 47 | 2.2 | - |
| 10 | Standard version | 2 x 0.4 | 47 | 2.2 | - |
| 15 | Standard version | 2 x 0.1 | 47 | 2.2 | - |
| 1 | Medical Version (M5) | 2 x 11 | 47 | - | 1 |
| 2 | Medical Version (M5) | 2 x 4 | 47 | - | 1 |
| 3 | Medical Version (M5) | 2 x 2.5 | 47 | - | 1 |
| 4 | Medical Version (M5) | 2 x 1.6 | 47 | - | 1 |
| 6 | Medical Version (M5) | 2 x 0.7 | 47 | - | 1 |
| 8 | Medical Version (M5) | 2 x 0.6 | 47 | - | 1 |
| 10 | Medical Version (M5) | 2 x 0.4 | 47 | - | 1 |
| 15 | Medical Version (M5) | 2 x 0.1 | 47 | - | 1 |
| 10 | Standard and Medical Version | 2 x 0.4 | 47 | 2.2 | 1 |

Diagrams

Standard version

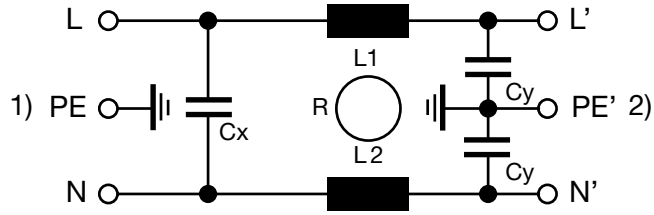

1) Line
2) Load

Medical Version (M5)

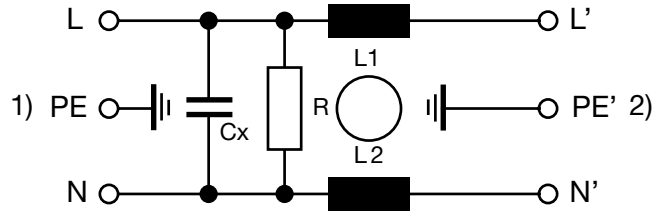

1) Line
2) Load

Attenuation Loss

--- 50Ω differential mode ___ 50Ω common mode

Standard version

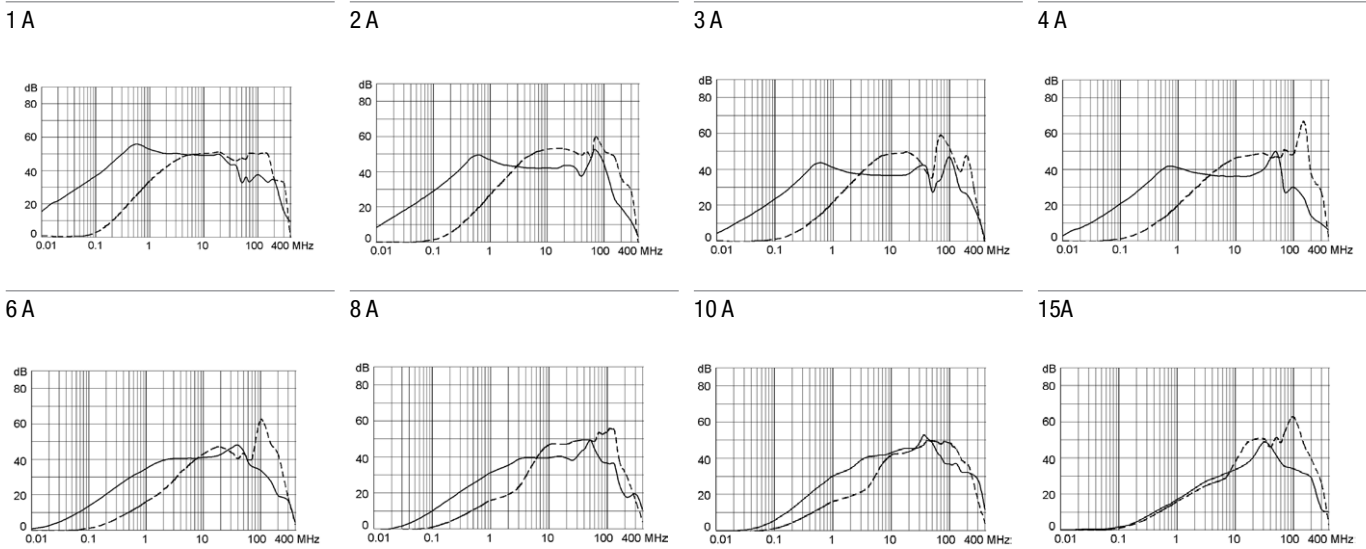

Medical version (M5)

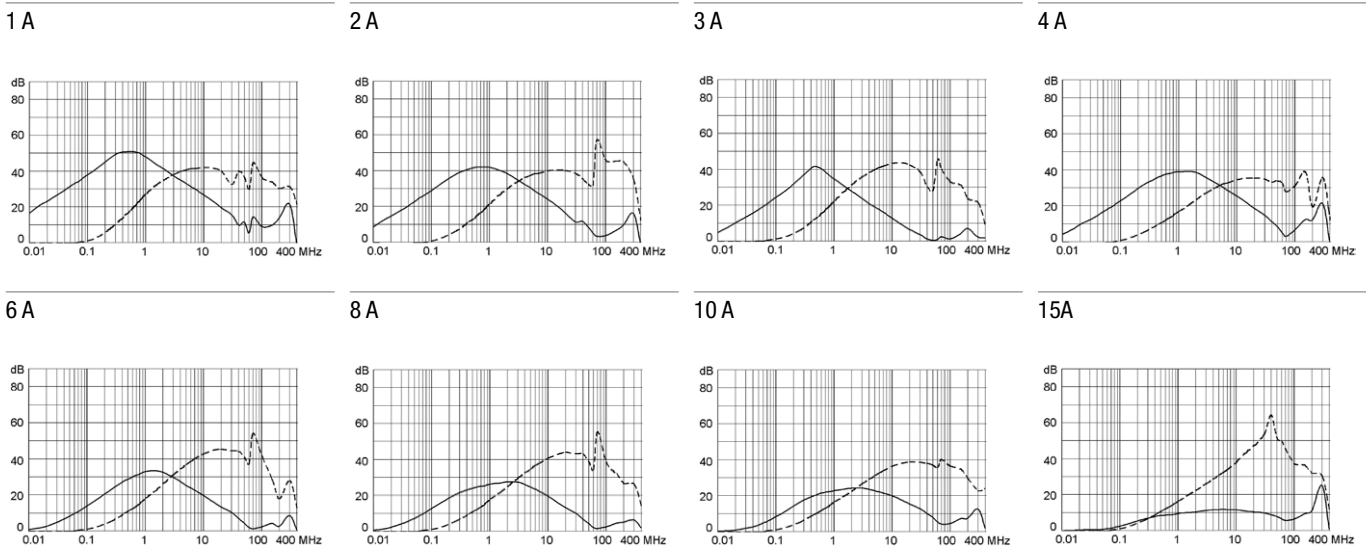

All Variants

| Rated Current [A] | Filter-Type | Panel mounting | Order Number |
|-------------------|----------------------|----------------|--------------|
| 1 | Standard version | Snap-in | 5110.0143.1 |
| 2 | Standard version | Snap-in | 5110.0243.1 |
| 3 | Standard version | Snap-in | 5110.0343.1 |
| 4 | Standard version | Snap-in | 5110.0443.1 |
| 6 | Standard version | Snap-in | 5110.0643.1 |
| 8 | Standard version | Snap-in | 5110.0843.1 |
| 10 | Standard version | Snap-in | 5110.1043.1 |
| 15 | Standard version | Snap-in | 5110.1543.1 |
| 1 | Standard version | Screw | 5110.0133.1 |
| 2 | Standard version | Screw | 5110.0233.1 |
| 3 | Standard version | Screw | 5110.0333.1 |
| 4 | Standard version | Screw | 5110.0433.1 |
| 6 | Standard version | Screw | 5110.0633.1 |
| 8 | Standard version | Screw | 5110.0833.1 |
| 10 | Standard version | Screw | 5110.1033.1 |
| 15 | Standard version | Screw | 5110.1533.1 |
| 1 | Medical Version (M5) | Snap-in | 5110.0143.3 |
| 2 | Medical Version (M5) | Snap-in | 5110.0243.3 |
| 3 | Medical Version (M5) | Snap-in | 5110.0343.3 |
| 4 | Medical Version (M5) | Snap-in | 5110.0443.3 |
| 6 | Medical Version (M5) | Snap-in | 5110.0643.3 |
| 8 | Medical Version (M5) | Snap-in | 5110.0843.3 |
| 10 | Medical Version (M5) | Snap-in | 5110.1043.3 |
| 15 | Medical Version (M5) | Snap-in | 5110.1543.3 |
| 1 | Medical Version (M5) | Screw | 5110.0133.3 |
| 2 | Medical Version (M5) | Screw | 5110.0233.3 |
| 3 | Medical Version (M5) | Screw | 5110.0333.3 |
| 4 | Medical Version (M5) | Screw | 5110.0433.3 |
| 6 | Medical Version (M5) | Screw | 5110.0633.3 |
| 8 | Medical Version (M5) | Screw | 5110.0833.3 |
| 10 | Medical Version (M5) | Screw | 5110.1033.3 |
| 15 | Medical Version (M5) | Screw | 5110.1533.3 |

Most Popular.

Availability for all products can be searched real-time:<https://www.schurter.com/en/Stock-Check/Stock-Check-SCHURTER>

Packaging unit 10 Pcs

Accessories

Description



Wire Harness
 Wire harness for SCHURTER products

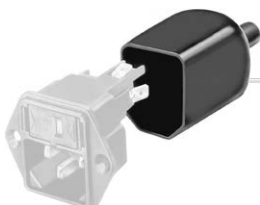

Assorted Covers
 Rear Cover

0859.0048



Cord retaining kits
 Cord retaining strain relief

| | |
|----------------|-----------|
| Flat head, A | 4700.0001 |
| Countersunk, C | 4700.0003 |

Mating Outlets/Connectors

Category / Description

[Appliance Outlet Overview complete](#)



4787, Mounting: Screw-on mounting, Appliance Outlet: IEC Solder terminals, 10 A, Suitable for appliances with protection class I 4787

4788, Mounting: Snap-in version, Appliance Outlet: IEC Solder terminals or quick connect terminals, 10 A, Suitable for appliances with protection class I 4788

IEC Appliance Outlet F or H, Screw-on Mounting, Front Side, Solder, PCB or Quick-connect Terminal 5091

[Appliance Outlet further types to 5110](#)

[Connector Overview complete](#)



4782 Mounting: Power Cord, 3 x 1 mm² / 3 x 18 AWG, Cable, Connector: IEC C13 4782

4785 Mounting: Power Cord, 3 x 1 mm² / 3 x 18 AWG, Cable, Connector: IEC C13 4785

4012 Mounting: Power Supply Cord, 3 x 1 mm², Screw clamps, Connector: IEC C13 4012

4300-06 Mounting: Power Cord, 3 x 1 mm² / 3 x 18 AWG, Cable, Connector: IEC C13 4300-06

4781 Mounting: Power Cord, 3 x 1 mm² / 3 x 18 AWG, Cable, Connector: IEC C15 4781

[Connector further types to 5110](#) ...