

Series CA8 Contactors and CAT8 Starters

An ingenious miniature contactor and starter system

Sprecher + Schuh's CA8 Series of miniature contactors and starters provide an extremely compact and reliable method of controlling motors of 7.5 HP or less (@460V). The CA8 is an economical choice for applications where space is limited or where a minimal enclosure is desired.

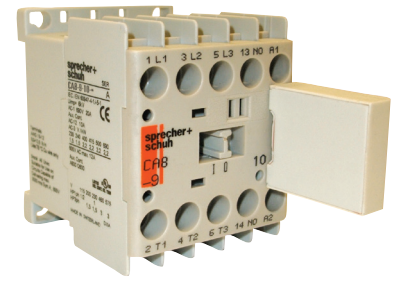

Small but rugged

Even though their contacts and coils are not replaceable, Sprecher + Schuh has subjected this series of contactors to monitored endurance tests that demonstrate their ruggedness. At full load, under 3-phase power, the contacts in the CA8 have an electrical life of 700,000 operations, while the AC magnet system has a mechanical life of 15,000,000 operations.

all auxiliary contact blocks can be snapped-on or removed without changing any existing power wiring. Other accessories include a snap-on RC Link (surge suppressor), mechanical interlocks and space saving adaptors for connecting auxiliary components.



The CAT8 Starter – Efficient and reliable

This miniature starter features the new CT8 Thermal Overload Relay. A complex current limiting calibration procedure performed after each unit ensures the consistent high quality of Sprecher + Schuh's thermal overload relay. Today's Class 10 T-frame design, like the CT8 Series, has been recognized by many motor manufacturers as the ideal type to assure optimum motor protection due to less use of copper and iron.



Effortless installation

Both the CA8 Contactor and the CAT8 Starter are DIN-rail mountable for instant installation and modification. Fittings are also included on the CA8 for base mounting. All terminals are clearly marked and shipped in the open position for installation with either manual or power screwdrivers.

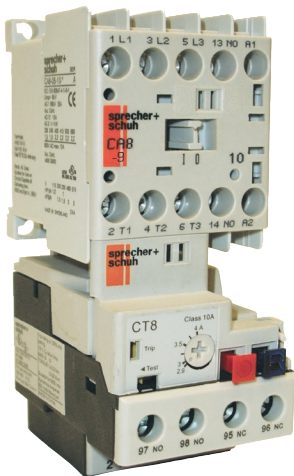

CAT8 starters feature the CT8 thermal overload.

Accessories require no additional panel space

The entire CA8 System is logically engineered. Modular accessories like auxiliary contact blocks snap-on without increasing the CA8's original width of 45mm. Also, due to its horizontal switching movement, the basic contactor has the same low profile whether an AC or DC operating magnet is used. This permits the use of enclosures with shallow mounting depths. Once the CA8 is installed,



45mm
(= 1 7/16)



9A
12A

A **Series CA8 Miniature Contactors, Starters, Overloads & Industrial Relays**

CA8 Contactors

- ✓ Rated 690V
- ✓ RoHs Compliant
- ✓ Conforming to U.S., Canadian, and IEC Standards
- ✓ Same Dimensions for AC and DC

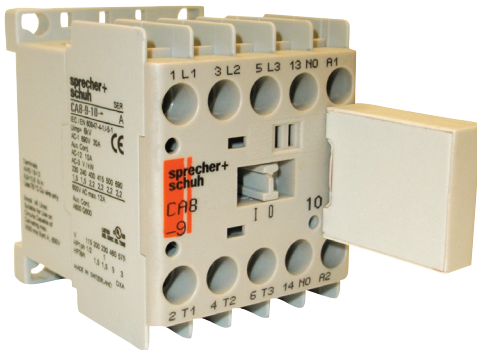
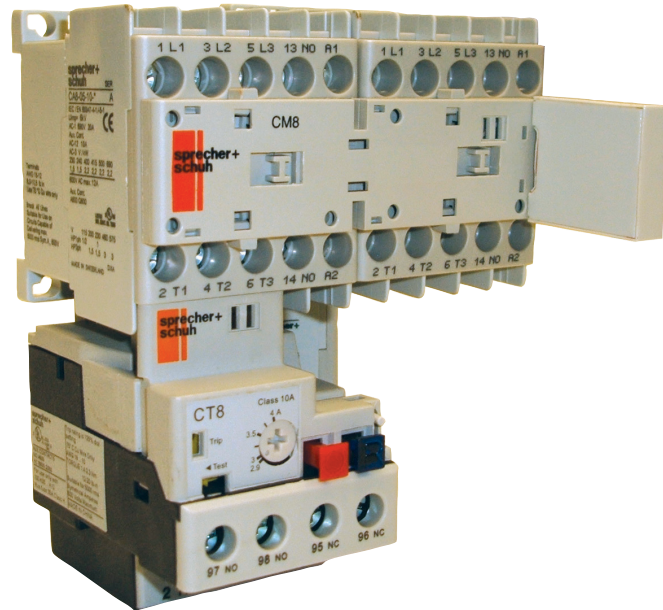

Pluggable Surge Suppressor Modules

- Suppressor modules are simply plugged on the front of the contactors, next to the auxiliary contact blocks.
- No wiring required.
- Fast and easy installation.

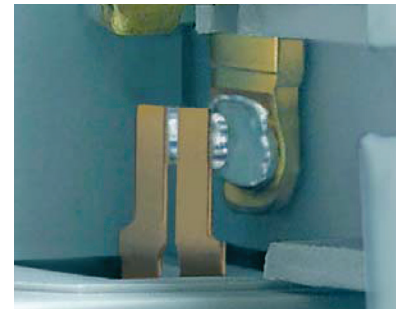

Auxiliary Contact Reliability

- Bifurcated, AgNi (silver/nickel) plated contacts for high contact reliability for 2mA/15V electronic signals.
- H-shaped self cleaning auxiliary contacts provide a 4-way current path ensure high contact reliability for low energy switching.

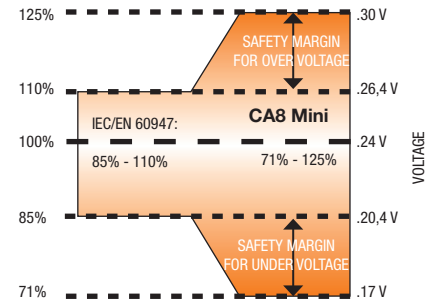
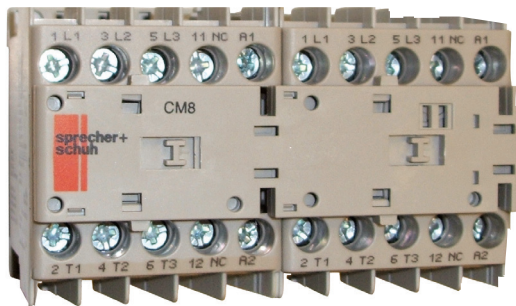

High Performance AC & DC Coils

- Wide range DC coils can provide reliability in case of over- and under-voltage, a common issue with battery-fed control power supply systems.
- The low coil consumption allows the contactors to be directly controlled via a PLC.
- Optional, integral factory-installed surge suppressor modules for AC and DC for limiting coil switching transients.

MIRROR AND MECHANICALLY LINKED DESIGN

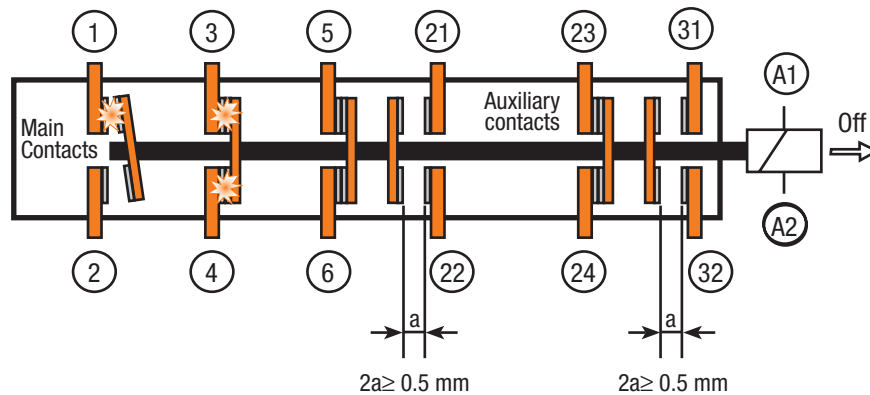

All Around Safety

- CA8: mechanically linked performance between main contacts and internal auxiliary contacts as per IEC 60947-5-1. This feature provides status feedback in the event of a contact weld.
- CA8/Auxiliary contacts: mechanically linked performance between main contacts and auxiliary contacts as per IEC 60947-5-1 for CA8 models with DC coils. Mechanically linked provides status feedback in the event of a contact weld. Mirror contact between main and auxiliary contacts as per IEC 60947-4-1 for CA8 models with AC coils. Mirror contacts prevent any unclear status indications if a N.O. power pole welds.

A
CA8 Contactors

Non-Reversing, Three Pole Contactors With AC Coil, Series CA8 (Open type only) ①⑦

I _e [A]	Ratings for Switching AC Motors (AC2 / AC3 / AC4)										Auxiliary Contacts per Contactor		Open Type	
	3 Ø kW (50 Hz)				UL/CSA HP (60 Hz)									
					1 Ø		3 Ø							
40°C														
AC-1	230V	400V 415V	500V	690V	115V	230V	200V	230V	460V	575V	NO	NC	Catalog Number	Price
20	3	4	4	4	1/2	1-1/2	2	2	5	5	1	0	CA8-09-10-*	101.18
											0	1	CA8-09-01-*	101.18
20	3	5.5	5.5	5.5	3/4	2	3	3	7-1/2	7-1/2	1	0	CA8-12-10-*	121.62
											0	1	CA8-12-01-*	121.62



CA8-09-10 contactor

Non-Reversing, Three Pole Contactors With DC Coil, Series CA8 (Open type only) ①②⑦

I _e [A]	Ratings for Switching AC Motors (AC2 / AC3 / AC4)										Auxiliary Contacts per Contactor		Open Type	
	3 Ø kW (50 Hz)				UL/CSA HP (60 Hz)									
					1 Ø		3 Ø							
40°C														
AC-1	230V	400V 415V	500V	690V	115V	230V	200V	230V	460V	575V	NO	NC	Catalog Number	Price
20	3	4	4	4	1/2	1-1/2	2	2	5	5	1	0	CA8-09C-10-*	123.66
											0	1	CA8-09C-01-*	123.66
20	3	5.5	5.5	5.5	3/4	2	3	3	7-1/2	7-1/2	1	0	CA8-12C-10-*	155.34
											0	1	CA8-12C-01-*	155.34

AC Coil Codes ①③

AC Coil Code	Voltage Range	
	50 Hz	60 Hz
12	12V	12V
24Z	24V	24V
48Z	48V	48V
120	110V	120V
208	200V-220V	208V-220V
240	240V	240V
380 ⑤	Use Coil Code 400	
400 ⑤	400V	400V
480	440V	480V
575 ⑥	Use Coil Code 600	
600 ⑥	525V	600V

DC Coil Codes ①③

DC Coil Code	Voltage
12D	12V
24D	24V ④
110D	110V
125D	125V
220D	220V

Ordering Instructions

Specify Catalog Number	
Replace (*) with Coil Code	See Coil Codes on this page

- ① CA8 not available without coil. Coils and contacts not replaceable.
- ② Select Coil Code from DC Coil Code table only.
- ③ The coil codes shown are the most commonly stocked items. Contact your Sprecher + Schuh representative to determine if other voltages are available.
- ④ Integrated diode surge suppressor coils available. Order coil code **24DD**. Example: CA8-09C-10-**24D** becomes CA8-09C-10-**24DD**. Add \$37.81 to list price.
- ⑤ The European Community has agreed that 400V is the nominal voltage in lieu of 380V. Use this code when 380V is required.
- ⑥ Use this code for 575V applications.
- ⑦ See page A27 regarding mechanically linked contacts and mirror contact performance.

Non-Reversing, Four Pole Contactors With AC Coil, Series CA8 (Open type only) ①④⑧

I _e [A]	Ratings for Switching AC Motors (AC2 / AC3)										Contact configuration main poles		Open Type	
	3 Ø kW (50 Hz)				UL/CSA HP (60 Hz)									
					1 Ø		3 Ø							
40°C	230V	400V	500V	690V	115V	230V	200V	230V	460V	575V	NO	NC	Catalog Number	Price
AC-1	230V	400V	500V	690V	115V	230V	200V	230V	460V	575V				
20	3	4	4	4	1/2	1-1/2	2	2	5	5	4	0	CA8-09-M40-*	101.18
											3	1	CA8-09-M31-*	116.51
											2	2	CA8-09-M22-*	116.51
20	3	5.5	5.5	5.5	3/4	2	3	3	7-1/2	7-1/2	4	0	CA8-12-M40-*	121.62
											3	1	CA8-12-M31-*	136.95
											2	2	CA8-12-M22-*	136.95



CA8-09-M40 contactor

Non-Reversing, Four Pole Contactors With DC Coil, Series CA8 (Open type only) ①②④⑧

I _e [A]	Ratings for Switching AC Motors (AC2 / AC3)										Contact configuration main poles		Open Type	
	3 Ø kW (50 Hz)				UL/CSA HP (60 Hz)									
					1 Ø		3 Ø							
40°C	230V	400V	500V	690V	115V	230V	200V	230V	460V	575V	NO	NC	Catalog Number	Price
AC-1	230V	400V	500V	690V	115V	230V	200V	230V	460V	575V				
20	3	4	4	4	1/2	1-1/2	2	2	5	5	4	0	CA8-09C-M40-*	123.66
											3	1	CA8-09C-M31-*	138.99
											2	2	CA8-09C-M22-*	138.99
20	3	5.5	5.5	5.5	3/4	2	3	3	7-1/2	7-1/2	4	0	CA8-12C-M40-*	155.34
											3	1	CA8-12C-M31-*	170.67
											2	2	CA8-12C-M22-*	170.67

AC Coil Codes ①③

AC Coil Code	Voltage Range	
	50 Hz	60 Hz
12	12V	12V
24Z	24V	24V
48Z	48V	48V
120	110V	120V
208	200V-220V	208V-220V
240	240V	240V
380 ⑥	Use Coil Code 400	
400 ⑥	400V	400V
480	440V	480V
575 ⑦	Use Coil Code 600	
600 ⑦	525V	600V

DC Coil Codes ①③

DC Coil Code	Voltage
12D	12V
24D	24V ⑥
110D	110V
125D	125V
220D	220V

Ordering Instructions

Specify Catalog Number	
Replace (*) with Coil Code	See Coil Codes on this page

- ① CA8 not available without coil. Coils and contacts not replaceable.
- ② Select Coil Code from DC Coil Code table only.
- ③ The coil codes shown are the most commonly stocked items. Contact your Sprecher + Schuh representative to determine if other voltages are available.
- ④ No auxiliary contacts provided in the base of a CA8. Add auxiliaries from page A21.
- ⑤ Integrated diode surge suppressor coils available. Order coil code **24DD**.
Example: CA8-09C-10-**24D** becomes CA8-09C-10-**24DD**. Add \$37.81 to list price.
- ⑥ The European Community has agreed that 400V is the nominal voltage in lieu of 380V. Use this code when 380V is required.
- ⑦ Use this code for 575V applications.
- ⑧ See page A27 regarding mechanically linked contacts and mirror contact performance.

A
CA8 Contactors

Reversing, Three Pole Contactors With AC Coil, Series CAU8 (Open type only) ①②③

I _e [A]	Ratings for Switching AC Motors (AC2 / AC3 / AC4)										Auxiliary Contacts per Contactor		Open Type	
	3 Ø kW (50 Hz)				UL/CSA HP (60 Hz)									
	40°C				1 Ø		3 Ø							
AC-1	230V	400V 415V	500V	690V	115V	230V	200V	230V	460V	575V	NO	NC	Catalog Number	Price
20	3	4	4	4	1/2	1-1/2	2	2	5	5	0	1	CAU8-09-02-∗-LW	238.13
											2	1	CAU8-09-42-∗-PW	251.41
20	3	5.5	5.5	5.5	3/4	2	3	3	7-1/2	7-1/2	0	1	CAU8-12-02-∗-LW	323.97
											2	1	CAU8-12-42-∗-PW	310.69



CAU8...LW Includes:

- Mechanical interlock (CM8)

CAU8...PW Includes:

- Mechanical and electrical interlock (CM8) ②
- Reversing power and control wiring (using Wiring Kit Cat.# CAUT8-PW)
- Top mount auxiliary contact block (Cat.# CA8-P20 on the -42- models)

Reversing, Three Pole Contactors With DC Coil, Series CAU8 (Open type only) ①②③

I _e [A]	Ratings for Switching AC Motors (AC2 / AC3 / AC4)										Auxiliary Contacts per Contactor		Open Type	
	3 Ø kW (50 Hz)				UL/CSA HP (60 Hz)									
	40°C				1 Ø		3 Ø							
AC-1	230V	400V 415V	500V	690V	115V	230V	200V	230V	460V	575V	NO	NC	Catalog Number	Price
20	3	4	4	4	1/2	1-1/2	2	2	5	5	0	1	CAU8-09C-02-∗-LW	299.45
											2	1	CAU8-09C-42-∗-PW	312.73
20	3	5.5	5.5	5.5	3/4	2	3	3	7-1/2	7-1/2	0	1	CAU8-12C-02-∗-LW	378.14
											2	1	CAU8-12C-42-∗-PW	391.43

AC Coil Codes ①③

AC Coil Code	Voltage Range	
	50 Hz	60 Hz
12	12V	12V
24Z	24V	24V
48Z	48V	48V
120	110V	120V
208	200V-220V	208V-220V
240	240V	240V
380 ⑤	Use Coil Code 400	
400 ⑤	400V	400V
480	440V	480V
575 ⑤	Use Coil Code 600	
600 ⑤	525V	600V

DC Coil Codes ①③

DC Coil Code	Voltage
12D	12V
24D	24V ④
110D	110V
125D	125V
220D	220V

Ordering Instructions

Specify Catalog Number	
Replace (∗) with Coil Code	See Coil Codes on this page

- ① CA8 not available without coil. Coils and contacts not replaceable.
- ② Internal NC contacts on each contactor are used for electrical interlocking.
- ③ The coil codes shown are the most commonly stocked items. Contact your Sprecher + Schuh representative to determine if other voltages are available.
- ④ Integrated diode surge suppressor coils available. Order coil code **24DD**. Example: CAU8-09C-02-**24D** becomes CAU8-09C-02-**24DD**. Add \$75.63 to list price.
- ⑤ The European Community has agreed that 400V is the nominal voltage in lieu of 380V. Use this code when 380V is required.
- ⑥ Use this code for 575V applications.
- ⑦ Does not apply to CAU8...-PW.
- ⑧ See page A27 regarding mechanically linked contacts and mirror contact performance.

Non-Reversing, Three Pole Starters With AC Coil, Series CAT8 (Open type only) ①⑦

I_e [A]	Ratings for Switching AC Motors (AC2 / AC3 / AC4)										Auxiliary Contacts per Contactor		Open Type	
	3 Ø kW (50 Hz)				UL/CSA HP (60 Hz)									
					1 Ø		3 Ø				NO	NC	Catalog Number	Price
40°C														
AC-1	230V	400V 415V	500V	690V	115V	230V	200V	230V	460V	575V				
20	3	4	4	4	1/2	1-1/2	2	2	5	5	1	0	CAT8-09-10-*-◆	171.7
											0	1	CAT8-09-01-*-◆	171.7
20	3	5.5	5.5	5.5	3/4	2	3	3	7-1/2	7-1/2	1	0	CAT8-12-10-*-◆	200.31
											0	1	CAT8-12-01-*-◆	200.31

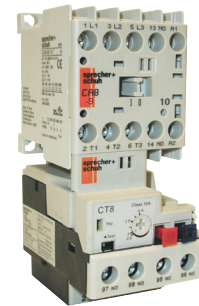

Representative model of a CAT8-09... starter with the CT8 bimetallic overload relay

Non-Reversing, Three Pole Starters With DC Coil, Series CAT8 (Open type only) ①②⑦

I_e [A]	Ratings for Switching AC Motors (AC2 / AC3 / AC4)										Auxiliary Contacts per Contactor		Open Type	
	3 Ø kW (50 Hz)				UL/CSA HP (60 Hz)									
					1 Ø		3 Ø				NO	NC	Catalog Number	Price
40°C														
AC-1	230V	400V 415V	500V	690V	115V	230V	200V	230V	460V	575V				
20	3	4	4	4	1/2	1-1/2	2	2	5	5	1	0	CAT8-09C-10-*-◆	195.20
											0	1	CAT8-09C-01-*-◆	195.20
20	3	5.5	5.5	5.5	3/4	2	3	3	7-1/2	7-1/2	1	0	CAT8-12C-10-*-◆	234.04
											0	1	CAT8-12C-01-*-◆	234.04

NOTE: CAT8 starters are priced to include Sprecher + Schuh's economical CT8 bimetallic overload relay. See A23 for selection.

AC Coil Codes ①③

AC Coil Code	Voltage Range	
	50 Hz	60 Hz
12	12V	12V
24Z	24V	24V
48Z	48V	48V
120	110V	120V
208	200V-220V	208V-220V
240	240V	240V
380 ⑥	Use Coil Code 400	
400 ⑥	400V	400V
480	440V	480V
575 ⑥	Use Coil Code 600	
600 ⑥	525V	600V

DC Coil Codes ①③

DC Coil Code	Voltage
12D	12V
24D	24V ④
110D	110V
125D	125V
220D	220V

Ordering Instructions

Specify Catalog Number	
Replace (*) with Coil Code	Coil Codes on this page O/L Relay Code on A23
Replace (◆) with O/L Relay Code	

- ① CA8 not available without coil. Coils and contacts not replaceable.
- ② Select Coil Code from DC Coil Code table only.
- ③ The coil codes shown are the most commonly stocked items. Contact your Sprecher + Schuh representative to determine if other voltages are available.
- ④ Integrated diode surge suppressor coils available. Order coil code **24DD**.
Example: CAT8-09C-10-**24D** becomes CAT8-09C-10-**24DD**. Add \$37.81 to list price.
- ⑤ The European Community has agreed that 400V is the nominal voltage in lieu of 380V. Use this code when 380V is required.
- ⑥ Use this code for 575V applications.
- ⑦ See page A27 regarding mechanically linked contacts and mirror contact performance.

A
CA8 Contactors

Reversing, Three Pole Starters With AC Coil, Series CAUT8 (Open type only) ①②⑦

I _e [A]	Ratings for Switching AC Motors (AC2 / AC3 / AC4)										Auxiliary Contacts per Contactor		Open Type	
	3 Ø kW (50 Hz)				UL/CSA HP (60 Hz)									
					1 Ø		3 Ø							
40°C														
AC-1	230V	400V 415V	500V	690V	115V	230V	200V	230V	460V	575V	NO	NC	Catalog Number	Price
20	3	4	4	4	~	~	2	2	5	5	0	1	CAUT8-09-02-*-*♦-LW	336.24
											2	1	CAUT8-09-42-*-*♦-PW	349.52
20	3	5.5	5.5	5.5	~	~	3	3	7-1/2	7-1/2	0	1	CAUT8-12-02-*-*♦-LW	404.71
											2	1	CAUT8-12-42-*-*♦-PW	418.00



CAUT8...LW Includes:

- Mechanical interlock
- Utilizes CT8 bimetallic overload relay. Select code from page A23.

CAUT8...PW Includes:

- Mechanical and electrical interlock ②
- Utilizes CT8 bimetallic overload relay. Select code from page A23.
- Reversing power and control wiring (using Wiring Kit Cat.# CAUT8-PW)
- Top mount auxiliary contact block (Cat.# CA8-P20 on the -42- models)

Reversing, Three Pole Starters With DC Coil, Series CAUT8 (Open type only) ①②⑦

I _e [A]	Ratings for Switching AC Motors (AC2 / AC3 / AC4)										Auxiliary Contacts per Contactor		Open Type	
	3 Ø kW (50 Hz)				UL/CSA HP (60 Hz)									
					1 Ø		3 Ø							
40°C														
AC-1	230V	400V 415V	500V	690V	115V	230V	200V	230V	460V	575V	NO	NC	Catalog Number	Price
20	3	4	4	4	~	~	2	2	5	5	0	1	CAUT8-09C-02-*-*♦-LW	423.11
											2	1	CAUT8-09C-42-*-*♦-PW	436.39
20	3	5.5	5.5	5.5	~	~	3	3	7-1/2	7-1/2	0	1	CAUT8-12C-02-*-*♦-LW	501.80
											2	1	CAUT8-12C-42-*-*♦-PW	515.09

AC Coil Codes ①③

AC Coil Code	Voltage Range	
	50 Hz	60 Hz
12	12V	12V
24Z	24V	24V
48Z	48V	48V
120	110V	120V
208	200V-220V	208V-220V
240	240V	240V
380 ⑤	Use Coil Code 400	
400 ⑤	400V	400V
480	440V	480V
575 ⑥	Use Coil Code 600	
600 ⑥	525V	600V

DC Coil Codes ①③



DC Coil Code	Voltage
12D	12V
24D	24V ④
110D	110V
125D	125V
220D	220V

Ordering Instructions

Specify Catalog Number	
Replace (*) with Coil Code	Coil Codes on this page O/L Relay Code on A23
Replace (♦) with O/L Relay Code	

- ① CA8 not available without coil. Coils and contacts not replaceable.
- ② NC contacts on each contactor are used for electrical interlocking.
- ③ The coil codes shown are the most commonly stocked items. Contact your Sprecher + Schuh representative to determine if other voltages are available.
- ④ Integrated diode surge suppressor coils available. Order coil code **24DD**. Example: CAUT8-09C-02-**24D** becomes CAUT8-09C-02-**24DD**. Add \$75.63 to list price.
- ⑤ The European Community has agreed that 400V is the nominal voltage in lieu of 380V. Use this code when 380V is required.
- ⑥ Use this code for 575V applications.
- ⑦ See page A27 regarding mechanically linked contacts and mirror contact performance.

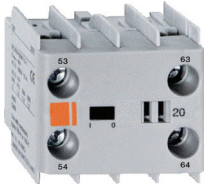
Auxiliary Contact Blocks (2 & 4 Pole) ①②

Auxiliary Contact Blocks	NO	NC	Contact Arrangement	Catalog No.	Price	Auxiliary Contact Blocks	NO	NC	Contact Arrangement	Catalog No.	Price
 <p>2-Pole</p> <p>Typical auxiliary contact block</p>	1	1		CA8-P11	25.14	 <p>2-Pole</p> <p>Typical auxiliary contact block</p>	1	1		CS8-P11E	25.14
	0	2		CA8-P02	25.14		0	2		CS8-P02E	25.14
	2	0		CA8-P20	25.14		2	0		CS8-P20E	25.14
	2	2		CA8-P22	49.36		2	2		CS8-P22Z	49.36
	3	1		CA8-P31	49.36		3	1		CS8-P31Z	49.36
 <p>4-Pole</p>	1	3		CA8-P13	49.36	1	3		CS8-P13E	49.36	
	0	4		CA8-P04	49.36	0	4		CS8-P04E	49.36	
	4	0		CA8-P40	49.36	4	0		CS8-P40E	49.36	

A
CA8 Contactors



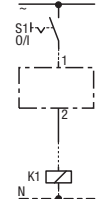



Electronic Timer

Module	Description	Function	Connection Diagrams	For use with...	Pkg Qty	Catalog Number	Price Each
	Solid-State Timing Element – • 110...250V AC or DC • Includes 35mm Hat Rail adapter	On-Delay 0.1...3 s On-Delay 1...30 s		CA8/CS8 all	10	CRZE8-3S CRZE8-30S	135.93

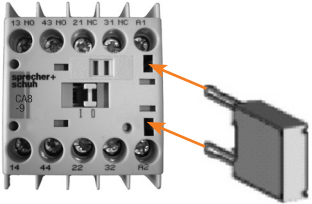
① Auxiliary contacts mirror contact performance per IEC 60947-4-1. Contacts are bifurcated (H-bridge) with a minimum rating of 2mA @ 15V.

② See page A27 regarding mechanically linked contacts and mirror contact performance.

Miscellaneous Accessories

Accessory	Description	Catalog Number	Price
	<p>Surge Suppressor CR__8 - for limiting voltage spikes when switching off coil. Coil itself provides sufficient limitation at voltages over 240V.</p> <p>RC Link (Type CRC8...) for AC Control 24-48VAC 110-280VAC 380-480VAC</p>	<p>CRC8-50 CRC8-280 CRC8-480</p>	<p>31.07</p>
	<p>Diode Link (Type CRD8...) for DC Control ❶ 12-250VDC (diode)</p>	<p>CRD8-250</p>	<p>31.07</p>
	<p>Varistor Link (Type CRV8...) for AC/DC Control 12-55VAC/12-77VDC 56-136VAC/78-180VDC 137-277VAC/181-250VDC</p>	<p>CRV8-55 CRV8-136 CRV8-277</p>	<p>31.07</p>
	<p>Mechanical Interlock Kit - For interlocking of two adjacent contactor – without additional space requirement in width – attachable from the front (top) of contactor – optional auxiliary contact blocks can be mounted on the top (does not interfere with mounting CR__8)</p>	<p>CM8</p>	<p>9.66</p>
	<p>Wiring Kit - For connecting line, load and control wiring of a CAU8 reversing contactor. – works with CT8 Overloads</p>	<p>CAUT8-PW</p>	<p>12.67</p>
	<p>Connection Modules - For KTA7 motor circuit controller with a CA8 contactor.</p>	<p>KT7-25S-PEK12</p>	<p>65.10</p>
	<p>Feeder Terminal for Compact Bus Bars - Supply of compact bus bars. For use with CA8-09 and CA8-12 34 Amps max.</p>	<p>CA8-WT</p>	<p>39.76</p>
	<p>Three-Phase Compact Bus Bars - For use with CA8-09 and CA8-12 Contactors with 45 mm spacing. (3 connections) 34 Amps max.</p>	<p>CA8-W453</p>	<p>48.55</p>
	<p>Three-Phase Compact Bus Bars - For use with CA8-09 and CA8-12 Contactors with 45 mm spacing. (4 connections) 34 Amps max.</p>	<p>CA8-W454</p>	<p>54.37</p>

❶ CA8 contactors with 24 VDC coils can be special ordered with integrated diodes (built-in) rather than applying CRD8 to the coil terminals.

CAT8 Starters with CT8 Thermal Overload Relay

For use with contactor....	Amp Range	Overload Relay Code (◆)	Catalog Number (of Overload Relay used)	Price Adder
1 or 3-Phase, Auto/Manual, Class 10				
CA8-09	0.10...0.16	8A16	CT8-A16	Standard
	0.16...0.25	8A25	CT8-A25	Standard
	0.25...0.4	8A40	CT8-A40	Standard
	0.35...0.5	8A50	CT8-A50	Standard
	0.45...0.63	8A63	CT8-A63	Standard
	0.55...0.8	8A80	CT8-A80	Standard
	0.75...1.0	8B10	CT8-B10	Standard
	0.90...1.3	8B13	CT8-B13	Standard
	1.10...1.6	8B16	CT8-B16	Standard
	1.4...2.0	8B20	CT8-B20	Standard
	1.8...2.5	8B25	CT8-B25	Standard
	2.3...3.2	8B32	CT8-B32	Standard
	2.9...4.0	8B40	CT8-B40	Standard
	3.5...4.8	8B48	CT8-B48	Standard
4.5...6.3	8B63	CT8-B63	Standard	
5.5...7.5	8B75	CT8-B75	Standard	
CA8-09 or 12	7.2...10	8C10	CT8-C10	Standard
CA8-12	9.0...12.5	8C12	CT8-C12	Standard

Obsolete Contactors Cross Reference, Series CA4 to Series CA8 (Open Type Only)

I_e [A]		Ratings for Switching AC Motors (AC2 / AC3 / AC4)									Auxiliary Contacts per Contactor		Series CA4 Obsolete Catalog Number	Series CA8 Replacement Catalog Number
		kW (50 Hz)			UL/CSA HP (60 Hz)									
		230V	400V 415V	500V	1 Ø		3 Ø							
AC-3	AC-1				115V	230V	200V	230V	460V	575V	NO	NC		
9	20	3	4	4	1/2	1-1/2	2	2	5	5	1	0	CA4-9-10	
											0	1	CA4-9-01	
~	20	3	4	4	1/2	1-1/2	2	2	5	5	1	0		CA8-09-10
											0	1		CA8-09-01
12	20	3	5.5	4	1/2	2	3	3	7-1/2	10	1	0	CA4-12-10	
											0	1	CA4-12-01	
~	20	3	5.5	5.5	3/4	2	3	3	7-1/2	7-1/2	1	0		CA8-12-10
											0	1		CA8-12-01



CA4-9-10 Contactor

Technical Information

		CA8-09		CA8-12				CA8-09		CA8-12	
Rated Insulation Voltage U_i						Wye-Delta (Star Delta)					
to IEC947-1		[V]	690V			50 Hz		≤230V	[A]	20	20
UL/CSA		[V]	600V					≤240V	[A]	20	20
Rated Impulse Voltage Withstand U_{imp}		[kV]	6					400V	[A]	15.5	15.5
Rated Voltage U_e-Main Contacts								415V	[A]	15.5	15.5
AC 50/60Hz		[V]	230, 240, 400, 415, 500, 690					500V	[A]	12.4	12.4
DC		[V]	24, 48, 110, 220, 440					690V	[A]	8.9	8.9
Operating Frequency for AC Loads		[Hz]	50/60Hz					230V	[kW]	5.5	5.5
Switching Motor Loads								240V	[kW]	5.5	5.5
Standard IEC Ratings								400V	[kW]	7.5	10
AC-2, AC-3, AC-4		230V	[A]	11.3	11.3			415V	[kW]	7.5	11
DOL & Reversing		240V	[A]	11.3	11.3			500V	[kW]	7.5	7.5
50Hz@60° C		400V	[A]	8.5	11.5			690V	[kW]	7.5	7.5
		415V	[A]	8.5	11.5			200V	[Hp]	3	5
		500V	[A]	6.8	9.2			230V	[Hp]	3	5
		690V	[A]	4.9	6.7			460V	[Hp]	7.5	10
		230V	[kW]	3	3			575V	[Hp]	7.5	10
		240V	[kW]	3	3			AC-1 Load, 3Ø Switching			
		400V	[kW]	4	5.5			Ambient Temperature 40° C			
		415V	[kW]	4	5.5			I_e	[A]	20	20
		500V	[kW]	4	5.5			230V	[kW]	8	8
		690V	[kW]	4	5.5			240V	[kW]	8.3	8.3
								400V	[kW]	14	14
								415V	[kW]	14	14
								500V	[kW]	17	17
								690V	[kW]	24	24
								Ambient Temperature 60° C			
								I_e	[A]	16	16
								230V	[kW]	6.4	6.4
								240V	[kW]	6.7	6.7
								400V	[kW]	11	11
								415V	[kW]	12	12
								500V	[kW]	14	14
								690V	[kW]	19	19
								Continuous Current (UL/CSA)			
								General Purpose Rating (40° C)			
								Open	[A]	15	18
								Enclosed	[A]	15	18
								Lighting Loads			
								Gas Dischrg.Lamps-AC-5a, 220...240VAC (40°C)			
								Enclosed	[A]	18	18
								Open	[A]	15	15
								Single compensated			
								10kA	[μF]	750	750
								Max. capacitance at prospective short circuit current available at the contactor			
								20kA	[μF]	400	400
								50kA	[μF]	~	~
								Incandescent Lamps			
								- AC-5b			
								Electrical endurance~100,000 operations 230/240V			
								[A]		9.0	9.0
Maximum Operating Rate		AC2	[ops/hour]	300	300						
At 9A for AC3; 20A for AC2/4		AC3	[ops/hour]	600	600						
Starting time $t_A = 0.25s$		AC4	[ops/hour]	300	300						
AC4 (200,000 Op. Cycles) 50Hz		230V	[A]	3.9	3.9						
		240V	[A]	3.9	3.9						
		400V	[A]	3.6	3.6						
		415V	[A]	3.6	3.6						
		500V	[A]	3.2	3.2						
		230V	[kW]	0.75	0.75						
		240V	[kW]	0.75	0.75						
		400V	[kW]	1.5	1.5						
		415V	[kW]	1.5	1.5						
		500V	[kW]	1.5	1.5						
Max. Operating Rate			[ops/hour]	250	250						

Electrical Data

		CA8-09	CA8-12			CA8-09	CA8-12
Switching power transformers AC-6a (50Hz)							
Inrush = η							
Rated transformer current	$\eta = 30$						
	$\leq 230V$	[A]	5.4				
	$\leq 240V$	[A]	5.4				
	$\leq 400V$	[A]	4.1				
	$\leq 415V$	[A]	4.1				
	$\leq 500V$	[A]	3.2				
	230VAC	[kVA]	2				
	240VAC	[kVA]	2				
	400VAC	[kVA]	2.8				
	415VAC	[kVA]	2.8				
	500VAC	[kVA]	2.8				
	690VAC	[kVA]	4				
DC Ratings							
DC-1 Rating at 60°C							
1 Pole	24VDC	[A]	9				
	48/60VDC	[A]	6/1.5				
	110VDC	[A]	1				
	220VDC	[A]	0.3				
	440VDC	[A]	0.1				
2 Pole in Series	24VDC	[A]	9				
	48/60VDC	[A]	8				
	110VDC	[A]	6				
	220VDC	[A]	1.2				
	440VDC	[A]	0.3				
3 Pole in Series	24VDC	[A]	9				
	48VDC	[A]	9				
	110VDC	[A]	9				
	220VDC	[A]	4				
	440VDC	[A]	0.6				
Shunt-wound Motors							
Starting, reverse current braking, reversing stepping DC-3, 60°C							
3 Poles in series	24V	[A]	9				
	48/60V	[A]	6				
	110V	[A]	3				
	220V	[A]	1.2				
	440V	[A]	0.2				
Series-wound Motors							
Starting, reverse current braking, reversing stepping DC-5, 60°C							
3 poles in series	24V	[A]	9				
	48/60V	[A]	3				
	110V	[A]	1				
	220V	[A]	0.1				
	440V	[A]	~				
Short Time Withstand-I_{CW}, 60°C							
	10s	[A]	96				
Short Circuit Coordination (Max. Fuse or Circuit Breaker Rating)							
50 kA Max. DIN fuse gG per IEC 60947-4-1 (Contactor and Fuse only)							
Available Fault Current							
Type 1 Coordination (690V)	max.	[A]	35				
Type 2 Coordination (690V)	max.	[A]	20				
Class K5 and RK5 fuses ①	max.	[A]	40				
Resistance and Watt Loss I_e AC3							
Resistance per power pole		[mΩ]	2.2				
Watt Loss - 3 power poles @400V		[W]	0.9				
Coil and AC @400V, warm		[W]	2.7				
3 power poles DC, warm		[W]	3.5				
Coil Data							
			CA8-09			CA8-12	
Voltage Range							
AC: 50Hz, 60Hz, 50/60 Hz	Pickup	[x U_s]				0.85...1.1	
	Dropout	[x U_s]				0.2...0.75	
DC	Pickup	[x U_s]				0.80...1.1	
	Dropout	[x U_s]				9, 12, 24, 110V DC: 0.7...1.25	
						0.1...0.75	
Coil Consumption							
AC: 50Hz, 60Hz, 50/60 Hz	Pickup	[VA]				35	
	Hold-in	[VA/W]				5/1.8	
DC	Pickup	[W]				cold 3.0, warm 2.6	
	Hold-in	[W]				cold 3.0, warm 2.6	
Operating Times							
AC: 50Hz, 60Hz, 50/60 Hz	Pickup	[ms]				15...40	
	Dropout	[ms]				15...33	
with RC Suppressor	Dropout	[ms]				15...28	
DC	Pickup	[ms]				18...40	
	Dropout	[ms]				6...12	
with Integ. Suppression	Dropout	[ms]				8...12	
with external diode Suppression	Dropout	[ms]				35...50	
Minimal changeover time for reversing		[ms]				>50	

① UL listed combination.

Mechanical Data

			CA8-09	CA8-12
Service Life				
Mechanical	AC/DC	[Mil.Op.]	15	
Electrical	AC-3(400V)	[Mil.Op.]	0.7	
Reversing combination, mechanical, electrical		[Mil.Op.]	0.7	

Shipping Weights

AC-CA8	[kg]	0.16
	[Lbs]	0.35
AC-CAU8	[kg]	0.35
	[Lbs]	0.77
DC-CA8	[kg]	0.20
	[Lbs]	0.44
DC-CAU8	[kg]	0.43
	[Lbs]	0.91

Terminations - Screw Type Terminals

Main contacts and Auxiliary contacts



Terminal Type	Combination	Screw Head: Cross, Slotted, Pozidrive		
Fine stranded w/ ferrule	1 wire	[mm ²]	0.75...2.5	
	2 wires	[mm ²]	0.75...2.5	
Solid or coarse stranded	1 wire	[mm ²]	1...4	
	2 wires	[mm ²]	1...2.5 + 1...4	
Torque Requirement		[AWG]	18...12	
		[Nm]	1.2	
		[Lb-in]	10.6	

Environmental and General Specifications

Ambient Temperature ②

Storage	-55...+80° C (-67...176° F)
Operation	-25...+60° C (-13...140° F) (40° C per UL)
Conditioned 15% current reduction after AC-1 at >60° C	-25...+70° C (-13...158° F)

Altitude at installed site 2000 meters above sea level per IEC 60947-4

Resistance to Corrosion / Humidity

Damp-alternating climate: cyclic to IEC 68-2, 56 cycles.
Dry Heat: IEC 68-2, +100°C (212°F), relative humidity <50%, 7 days.
Damp tropical: IEC 68-2, +40°C (104°F), relative humidity <92%, 56 days.

Shock Resistance IEC 68-2/EN 60068

Vibration Resistance IEC 68-2/EN 60068

Operating Position Refer to Dimension Page A29

Standards IEC/EN 60947-1, -4-1, -5-1, -5-4;
UL 508; CSA 22.2. No. 14

Approvals CE, cULus, CCC

High Fault Short Circuit Ratings per UL508 and CSA 22.2 No.14

Overload Cat. No.	Contactor Cat. No.	Max. starter FLC (A)	Fuse Ratings			UL Listed Circuit Breaker Ratings ①			Group Installation ①	
			Max. available fault current (kA)	Max. voltage (V)	UL Class J, CC, CSA HRCI-J fuse max. (A)	Short Circuit Rating (kA)	Max. voltage (V)	Max. CB Rating (A)	Max. CB rating (A)	
CT8	A16...A40	CA8-09	10	50	600	1	5	600	15	30
	A50...A63					2				
	A80...B10					3				
	B13					4				
	B16					5				
	B20					8				
	B25					10				
	B32					12				
	B40...B48					15				
	B63					20				
	B75					25				
	C10					CA8-09...12				
	C12	CA8-12	13.8			50				

① Group installation ratings can be applied when used with CA8 Compact Bus Bars (see A22) in a minimum 1,152 cu. in. enclosure with two latches.

② Ambient is the temperature outside the enclosure.

Auxiliary Contacts

		Built-in Auxiliary Contacts										Add-on Auxiliary Contacts									
Current Switching																					
AC-12 I_{th}	at 40°C [A]	10										10									
	at 60°C [A]	6										6									
AC-15, switching electromagnetic loads at:	[V]	24	120	240	400	480	500	600	690			24	120	240	400	480	500	600	690		
	[A]	6	6	3	1.8	1.5	1.4	1.2	1			3	3	2	1.2	1	1	0.6	0.6		
DC-13, switching DC electromagnets at:	[V]	24	48	110	125	220	250	400	440	600		24	48	110	125	220	250	400	440	600	
	[A]	2.8	1.2	0.55	0.55	0.27	0.27	0.15	0.15	0.10		2.3	1	0.55	0.55	0.27	0.27	0.15	0.15	0.10	
DC-12, L/R < 1 ms resistive loads at:	[V]	24	48	110	125	220	250	400	440												
	[A]	6	4	0.6	0.6	0.2	0.2	0.08	0.08												
DC-14, L/R < 15 ms inductive loads with economy resistor in series at:	[V]	24	48	110	125	220	250	400	440												
	[A]	4	2.5	0.4	0.4	0.12	0.12	0.05	0.05												
Low Level Signal Switching																					
Contact design		X-stamped										H-bridge, bi-furcated									
Minimum switching recommendation	[V]	17V										15V									
	[mA]	10mA										2mA									
Short-Circuit Protection - gG Fuse																					
Type 2 Coordination	[A]	10										10									
Load carrying capacity per UL/CSA																					
Rated Voltage	AC [V]	600 max.										600 max.									
Continuous Rating	40°C [A]	10 general purpose										10 general purpose									
Switching Capacity	AC	Heavy pilot duty (A600)										Heavy pilot duty (B600)									
Rated Voltage	DC [V]	600 max.										600 max.									
Switching Capacity	DC	Standard pilot duty (Q600)										Standard pilot duty (Q600)									
Mechanically Linked Contacts IEC 60947-5-1, Annex L		Yes										No									
Mirror Contacts IEC 60947-4, Annex F		Yes										Yes									

Contact Ratings (Per NEMA/UL A600, B600 & Q600)

Standard	Circuit Voltage	Make (Amps/VA)	Break (Amps/VA)	Continuous Amps
A600	120AC	60A/7200VA	60A/720VA	10
	240AC	30A/7200VA	30A/720VA	
	480AC	15A/7200VA	15A/720VA	
	600AC	12A/7200VA	12A/720VA	
B600	120AC	30A/3600VA	3.0A/360VA	10
	240AC	15A/3600VA	1.5A/360VA	
	480AC	7.5A/3600VA	0.75A/360VA	
	600AC	6A/3600VA	0.60A/360VA	
Q600	125DC	0.55/69VA	0.55/69VA	2.5
	250DC	0.27/69VA	0.27/69VA	
	301-600DC	0.1A/69VA	0.1A/69VA	

Mechanically Linked Contacts and Mirror Contact Performance

Type	Coil	Add-on Auxiliary Contact	Conforms to IEC	Status
CA8	AC or DC	None	60947-5-1	Mechanically linked within the base contactor
	DC	Yes	60947-5-1	Mechanically linked within the base contactor and with add-on auxiliary contacts
	AC	Yes	60947-4-1	Mechanically linked within the base contactor and mirror contact performance with add-on auxiliary contacts

Definitions

- Mechanically linked contacts (IEC 60947-5-1 Annex L):
 - N.C. Auxiliary Contact will not re-close if a N.O. power pole welds.
 - N.O. Power Pole or Auxiliary Contact will not close if N.C. contact welds.
 - The term "Positive Guided" contacts is the same as mechanically linked.
- Mirror Contacts (IEC 60947-4-1 Annex F): N.C. Auxiliary Contact will not be in closed position if a N.O. power pole welds.

Life-Load Curves

- Locate the Rated Operational Current (I_e) along the bottom of the chart and follow the graph lines up to the intersection of the appropriate contactor's life-load curve.
- Read the estimated contact life along the vertical axis.

Instructions on **How to** read Life Curves

can be found on page A8

AC-1, AC3
(400...460V AC)

AC-1 Non- or slightly inductive loads, resistance furnaces;
AC-3 Switching of squirrel-cage motors while starting
 $U_e = 400...415$ VAC

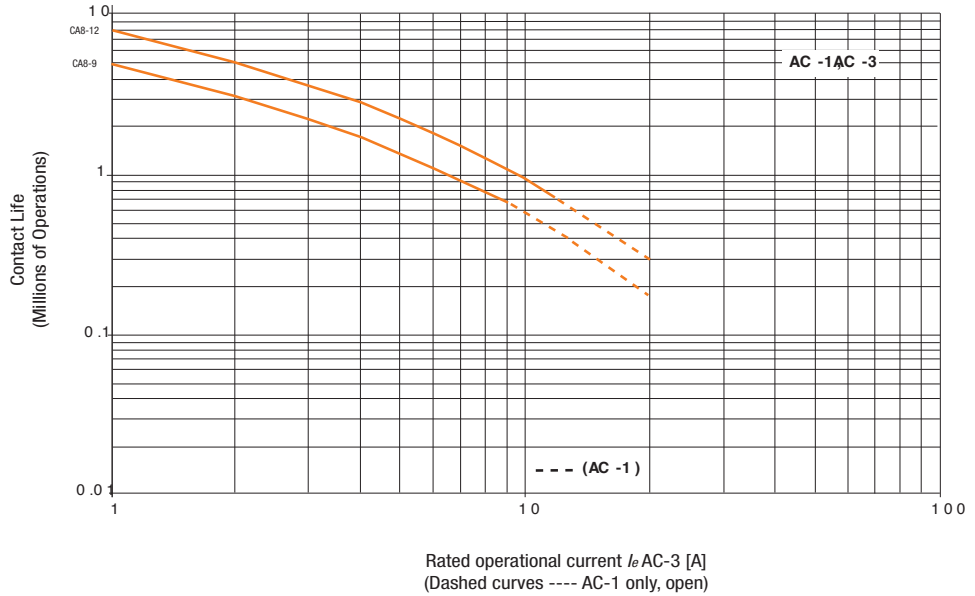

AC-4
(400...460V AC)

AC-4 Stepping of squirrel-cage motors
 $U_e = 400...415$ VAC

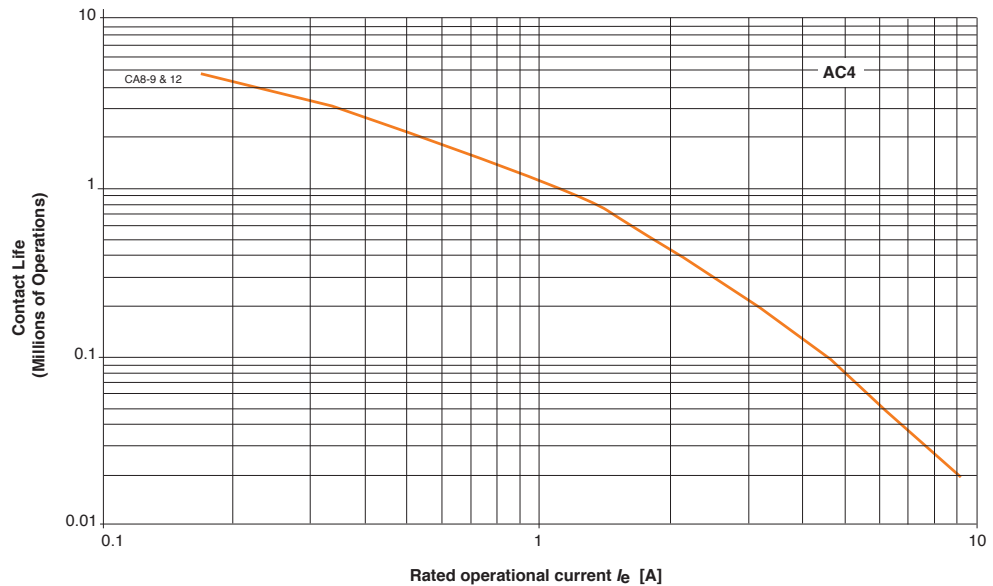

NOTE: The life-load curves shown here are based on Sprecher+Schuh tests according to the requirements defined in IEC 60947-4-1. Since contact life in any given application is dependent on environmental conditions and duty cycle, actual application contact life may vary from that indicated by the curves shown here.

Series CA8 & Series CAU8 (Contactors & Reversing Contactors)

Dimensions are in millimeters (inches). Dimensions not intended for manufacturing purposes.

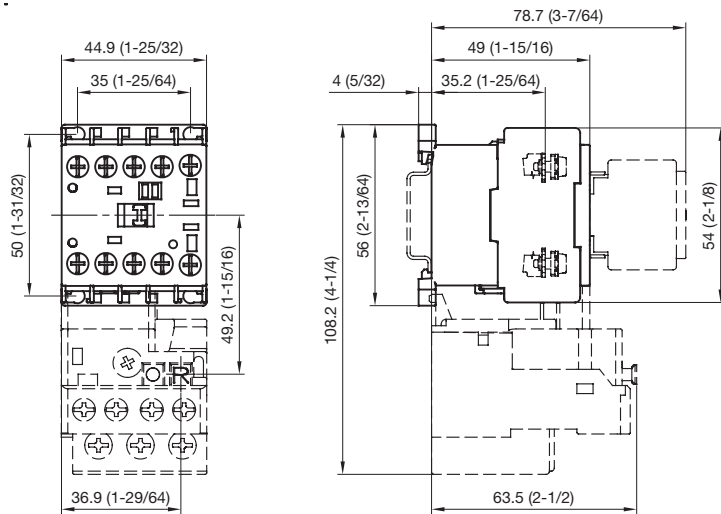

Mounting Position with Accessories

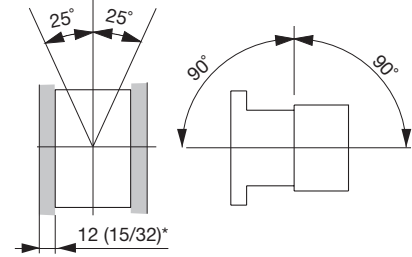

* Minimum distance to grounded parts or walls

Reversing Contactors & Accessories

Contactor with...	Dim. [mm]	Dim. [inches]
reversing with mechanical interlock	89.8	3.53
with aux. contact block	78.7	3.1
with timer		
on contactor	81.7	3.25
at side of contactor	66.9	2.63
with neutral terminal		
at side of contactor	64.9	2.56
with protection element		
with nameplate	51	2