

Terminals

Terminals

Series V7-W Screw Terminals - General Description	N2
<i>Quick Selection Guide</i>	N3
Standard Feed-Through Blocks	N5
Specialty Feed-Through Blocks	N8
Grounding Blocks	N10
Fuse Blocks	N13
Isolation Blocks	N16
Sensor Blocks	N18
Plug-in Style Blocks	N20
Component Blocks	N22
Thermocouple Blocks	N23
<i>Accessories Matrix</i>	N24
<i>Technical Information</i>	N31
<i>Dimensions</i>	N35
Series V7 Terminal Marking Systems - General Description	N38
<i>Marker Coordination Table</i>	N40
<i>Marker Cards, Tabs and Rods</i>	N41
<i>Custom Printed Marker Cards</i>	N45
V7 Plotter System and Accessories	N47

Series V7-W Terminals

A comprehensive selection of rugged connections



Sprecher + Schuh's new V7-W terminals are designed to meet the three most important criteria when selecting a terminal block line – ease of wiring, secure connections and durability. The line is also comprehensive, offering a wide array of terminal types for most circuits and functions, from control to low level power.

The size you need

V7-W feed-through terminals come in ten sizes and are rated to 600VAC (800V-IEC). They accommodate a full range of wire sizes from 30AWG to 3/0 AWG (0.5mm² to 70mm² wire cross section). Many “specialty” feed-through terminals are also available that provide multiple terminations or increase the density of connections. This reduces panel space and saves money.

Comprehensive selection of special terminals

Aside from the broad selection of standard feed-through terminals, many special terminals are also part of the new V7-W line, including:

- Two level terminals
- High Current terminals
- Ground terminals
- Dual connection terminals
- Diode terminals
- Plug-in style terminals
- Various isolating terminals
- Fuse terminals
- Sensor terminals
- Thermocouple terminals
- Proximity switch terminals

Even the most varied circuit requirements can be supported by the broad selection offered with this line.

Super reliable connections

The most important aspect of a terminal block is to join wires in a reliable connection. With V7-W terminals, a cone shaped guide allows easy insertion of the wire into a nickel plated barrel. As tightening torque is applied to strong stainless steel screws, the wire is secured between a recessed contact

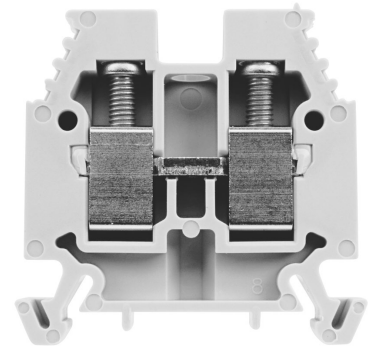

Stainless steel screws and nickel plated current bars provide a strong, corrosion resistant connection

pad and serrated current bar. This corrosion-resistant clamping mechanism provides excellent performance in the most demanding industrial conditions.







Superior insulation and protection features

All metal parts are recessed, providing a touch-safe, dead front design for optimum safety. Terminal bodies are manufactured from Polyamide 6.6, known for its excellent thermal stability, impact resistance and resistance to electrical creepage. The insulating cases are rated up to 90°C (195°) for continuous operation. They also stay elastic down to -40°C (-40°F) without fracturing.



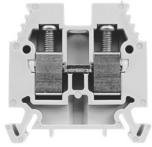

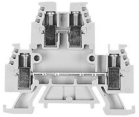

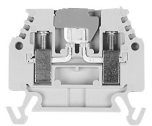
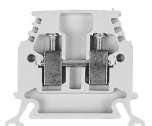
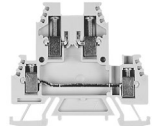
International approvals

Sprecher + Schuh's V7-W terminal block line is UL recognized and CSA Certified. Many terminals have also been certified for use in hazardous locations. The line also carries the CE Mark for use in most international markets.

Quick Selection Guide (refer to page indicated for complete information and detailed pricing)

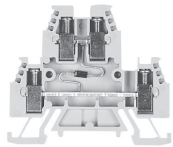
Terminal	Description	Type	Overall Term. Width	Cross-sec. [mm ²]	Catalog Number	See Page...	
Through Terminals							
	Standard Feed-Through Blocks Provides one straight-through circuit for wire sizes up to 70 mm ² .	Color: gray (other colors available)	5	2.5	V7-W3	N5	
			6	4	V7-W4	N5	
			7	6	V7-W6	N5	
			8	10	V7-W10	N6	
			11	16	V7-W16S	N6	
			14	35	V7-W35	N7	
			23	70	V7-W70	N7	
  	Specialty Feed-Through Blocks Provides one straight-through circuit with 3 wire terminals.	Color: gray (other colors available)	5	2.5	V7-W3TW	N9	
		Return Terminals Single circuit terminal block with terminals on common side.	Color: gray	5	2.5	V7-WR3	N9
			Two Level Terminals	Color: gray	5	2.5	V7-WD3
	6	4		V7-WD4	N8		
	7	6		V7-WD6	N8		
Ground Terminals							
	Grounding Terminals	Color: green / yellow	6	4	V7-WG4	N10	
			7	6	V7-WG6	N10	
			8	10	V7-WG10S	N10	
			13	16	V7-WG16	N11	
			18	35	V7-WG35	N11	
			22	70	V7-WG70	N11	
			6	2.5	V7-WDG4C	N12	
Isolation and Plug-in Style Blocks							
	Knife Style Isolation Blocks Used to isolate a circuit after power has been removed by an appropriate disconnect switch.	Color: gray	5	2.5	V7-WKD3	N16	
			5	2.5	V7-WKD3TP	N16	
			9	6	V7-WKD6	N16	
	Handle Style Isolation Block Used to isolate a circuit after power has been removed by an appropriate disconnect switch.	Color: black	9	4	V7-H7	N17	
		Plug-in Style Block Accepts plugs listed on opposite page.	without insert	6	2.5	V7-W4P	N20
	without insert, with test plug screws		6	2.5	V7-W4PTP	N20	
	Two & Three Level Plug-in Style Terminal Blocks - Accepts plugs listed on opposite page.	two level, without insert	6	2.5	V7-WD4P	N21	
		three level, without insert, with ground	6	2.5	V7-WDG4P	N21	

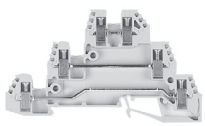
Quick Selection Guide (refer to page indicated for complete information and detailed pricing)

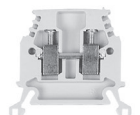
Terminal	Description	Type	Overall Term. Width	Cross-sec. [mm ²]	Catalog Number	See Page...
Isolation and Plug-in Style Blocks (continued)						
Inserts for V7-W4P— Order Separately						
	Disconnect Plug				V7-DP4	N28
	Component Plug				V7-CP4	N28
	Fuse Plug	5 x 20 mm; without indication 5 x 20 mm; with LED 5 x 20 mm; with LED			V7-FP4 V7-FP424 V7-FP4250	N28
Two Level Component Terminals						
	Diode Terminals	with a fixed connection with a diode in forward bias with a diode in reverse bias	6 6 6	4 4 4	V7-WD4C V7-WD4DF V7-WD4DR	N22
Fusible Terminals						
	Fuse Terminals (fuses not supplied)	5 x 20 mm, without indication 5 x 20 mm, without indication 5 x 20 mm, with LED 5 x 20 mm, with neon lamp 6.3 x 32 mm, without indication 6.3 x 32 mm, without indication 6.3 x 32 mm, with LED 6.3 x 32 mm, with neon lamp	8 8 8 8 9 9 9 9	4 4 4 4 4 4 4 4	V7-WFB4 V7-WFB10V V7-WFB424 V7-WFB4250 V7-H6 V7-WFB10VA V7-H5 V7-H4	N13 N15 N13 N13 N14 N15 N14 N14
Sensor Terminals						
	Sensor Supply Terminal (Initiator)	without LED with LED PNP with LED NPN	5 5 5	2.5 2.5 2.5	V7-WTF3 V7-WTF3LP V7-WTF3LN	N18 N18 N18
	Sensor Terminal (Initiator)	no indicator with LED PNP with LED NPN	5 5 5	2.5 2.5 2.5	V7-WTS3 V7-WTS3LP V7-WTS3LN	N19 N19 N19
Thermocouple Terminals						
	Thermocouple Terminals	Chromel / Constantan Iron / Constantan Copper / Constantan	10 10 10	2.5 2.5 2.5	V7-WTC3E V7-WTC3J V7-WTC3T	N23 N23 N23

Standard Feed-Through Blocks ①

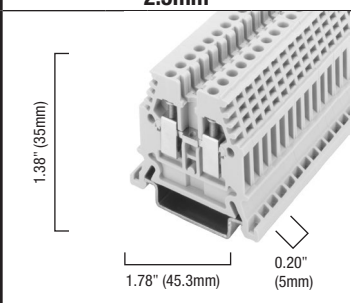
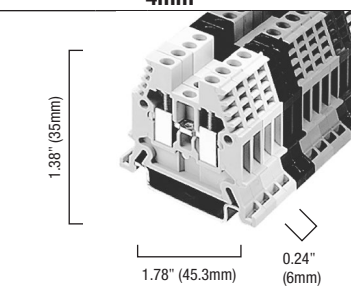
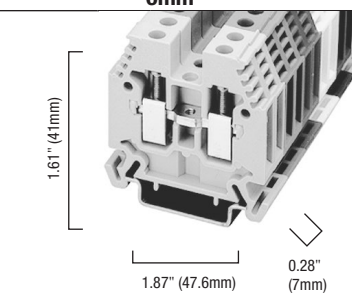
Ordering and Technical Information ①	2.5mm ²			4mm ²			6mm ²		
									
	Single circuit terminal block			Single circuit terminal block			Single circuit terminal block		
	Catalog Number	Price Ea. (Std Pkg)	Pkg. Qty	Catalog Number	Price Ea. (Std Pkg)	Pkg. Qty	Catalog Number	Price Ea. (Std Pkg)	Pkg. Qty
Terminal -	Gray V7-W3	2.70	50	V7-W4	3.10	50	V7-W6	3.25	50
	Red V7-W3-RE	2.85	50	V7-W4-RE	3.25	50	V7-W6-RE	3.50	50
	Blue V7-W3-B	2.85	50	V7-W4-B	3.25	50	V7-W6-B	3.50	50
	Black V7-W3-BL	2.85	50	V7-W4-BL	3.25	50	V7-W6-BL	3.50	50
	Green V7-W3-G	2.85	50	V7-W4-G	3.25	50	V7-W6-G	3.50	50
	Yellow V7-W3-Y	2.85	50	V7-W4-Y	3.25	50	V7-W6-Y	3.50	50
	Orange V7-W3-OR	2.85	50	V7-W4-OR	3.25	50	V7-W6-OR	3.50	50
	White V7-W3-W	2.85	50	V7-W4-W	3.25	50	V7-W6-W	3.50	50
	Brown V7-W3-BR	2.85	50	V7-W4-BR	3.25	50	V7-W6-BR	3.50	50
Accessories (also see pages N26 to N31)									
End Barrier	V7-EB3	1.20	50	V7-EB3	1.20	50	V7-EB10	1.20	50
End Anchors									
DIN Rail — Normal Duty	V7-EA35	1.75	50	V7-EA35	1.75	50	V7-EA35	1.75	50
DIN Rail — Heavy Duty	V7-EAH35	7.00	10	V7-EAH35	7.00	10	V7-EAH35	7.00	10
DIN Rail — Snap-in	V7-ER35	1.80	50	V7-ER35	1.80	50	V7-ER35	1.80	50
Jumpers									
Side Jumper — 10-pole Insulated	V7-SJ5-10	3.60	10	V7-SJ6-10	4.45	10	V7-CJ7-40 (40 pole)	37.00	5
Center Jumper — 50-pole	V7-CJ5-50	42.00	5	V7-CJ6-50	37.00	5	V7-CJ7-10	11.00	10
Center Jumper — 10-pole	V7-CJ5-10	8.90	10	V7-CJ6-10	9.40	10	V7-CJ7-3	4.10	10
Center Jumper — 3-pole	V7-CJ5-3	3.30	10	V7-CJ6-3	3.50	10	V7-CJ7-2	2.90	10
Center Jumper — 2-pole	V7-CJ5-2	2.25	10	V7-CJ6-2	2.40	10	V7-CJL7	1.35	10
Center Jumper Link	V7-CJL5	1.35	10	V7-CJL6	1.35	10	V7-CJL7	1.35	10
Center Jumper Cover — White	V7-CJCW5 ②	5.30	20	V7-CJCW6	5.30	20	V7-CJCW6	5.30	20
Other Accessories									
Partition Plate	V7-PP3	1.50	50	V7-PP3	1.50	50	V7-PP10	1.80	50
Separation Plate	V7-SP3	.90	50	V7-SP3	.90	50	V7-TP28	8.90	10
Test Plug				V7-TP28	8.90	10			
Test Plug				V7-TP6E	13.00	10			
Test Plug				V7-TP6EWL	13.00	10			
Test Plug Adapter	V7-TA285	17.75	10	V7-TA40	17.75	10	V7-TA40	17.75	10
Electrical Warning Plate (1-pole)	V7-EWP5	2.25	10	V7-EWP5	2.25	10	V7-EWP7	2.25	10
Screwdriver ③	V7-SCRDRV1	16.50	1	V7-SCRDRV1	16.50	1	V7-SCRDRV1	16.50	1
Marking Systems ④									
Blank Tags (cards of 100)	V7-SM5X9	12.00	5	V7-SM6X12	12.00	5	V7-SM6X12	12.00	5
	V7-SM5X12	12.00	5						
Pre-printed Tags (sticks of 10)	V7-MP5 ⑤	2.70	10	V7-MP ⑤	2.70	10	V7-MP ⑤	2.70	10
Terminal Block Specifications									
Approvals	UL	UL	IEC	UL	UL	IEC	UL	UL	IEC
Voltage Rating	600V AC/DC	600V AC/DC	800V AC/DC	600V AC/DC	600V AC/DC	800V AC/DC	600V AC/DC	600V AC/DC	800V AC/DC
Maximum Current	20 A	20 A	24 A	30 A	30 A	32 A	40 A	40 A	41 A
Wire Range (Rated Cross Section)	#22...#14 AWG	#30...#14 AWG	0.5...2.5mm ²	#22...#10 AWG	#22...#10 AWG	0.5...4mm ²	#22...#10 AWG	#22...#10 AWG	0.5...6mm ²
Wire Strip Length	0.39" (10 mm)			0.35" (9 mm)			0.47" (12 mm)		
Recommended Tightening Torque	5.0...5.6 lb-in. (0.6 Nm)			5.0...5.6 lb-in. (0.6 Nm)			5.6...6.8 lb-in. (0.7 Nm)		
Density	61 pcs./ft (200/m)			50 pcs./ft (166/m)			43 pcs./ft (142/m)		
Insulation Temperature Range	-40°...+195°F (-40°...+90°C)			-40°...+195°F (-40°...+90°C)			-40°...+195°F (-40°...+90°C)		
Mounting Rail	Fits all types shown on page N32			Fits all types shown on page N32			Fits all types shown on page N32		

① Special order with minimum quantities may be required for certain terminal colors.

② May only be used as a marking surface. Cannot be installed over a center jumper.

③ Specially designed to fit the screws on V7-W3, W4 and W6 terminals.

④ Custom marking tags available. See page N45 for full offering.

⑤ Catalog number is not complete. See pages N42...N43.

Standard Feed-Through Blocks ①

Ordering and Technical Information ①	10mm ²			16mm ²		
	Single circuit terminal block			Single circuit terminal block		
	Catalog Number	Price Ea. (Std Pkg)	Pkg. Qty	Catalog Number	Price Ea. (Std Pkg)	Pkg. Qty
Terminal - Gray Red Blue Black Green Yellow Orange White Brown	V7-W10	4.00	50	V7-W16S	6.90	50
	V7-W10-RE	4.10	50	V7-W16S-RE	7.20	50
	V7-W10-B	4.10	50	V7-W16S-B	7.20	50
	V7-W10-BL	4.10	50	V7-W16S-BL	7.20	50
	V7-W10-G	4.10	50	V7-W16S-G	7.20	50
	V7-W10-Y	4.10	50	V7-W16S-Y	7.20	50
	V7-W10-OR	4.10	50	V7-W16S-OR	7.20	50
	V7-W10-W	4.10	50	V7-W16S-W	7.20	50
	V7-W10-BR	4.10	50	V7-W16S-BR	7.20	50
	Accessories (also see pages N26 to N31)					
End Barrier	V7-EB10	1.20	50	V7-EB10	1.20	50
End Anchors DIN Rail — Normal Duty DIN Rail — Heavy Duty DIN Rail — Snap-in	V7-EA35	1.75	50	V7-EA35	1.75	50
	V7-EAH35	7.00	10	V7-EAH35	7.00	10
	V7-ER35	1.80	50	V7-ER35	1.80	50
Jumpers Side Jumper – 10-pole Insulated Center Jumper – 40-pole Center Jumper – 10-pole Center Jumper – 3-pole Center Jumper – 2-pole Center Jumper Link Center Jumper Cover – White ②	V7-SJ8-10	8.40	10			
	V7-CJ8-40	42.00	5			
	V7-CJ8-10	12.20	10	V7-CJS11-10	23.75	10
	V7-CJ8-3	4.10	10	V7-CJS11-3	7.10	10
	V7-CJ8-2	3.10	10	V7-CJS11-2	5.30	10
	V7-CJL8	1.35	10			
	V7-CJCW6	5.30	20			
Other Accessories Partition Plate Test Plug Test Plug Adapter Electrical Warning Plate (1-pole) Group Marking Carrier	V7-PP10	1.80	50	V7-PP10	1.80	50
	V7-TP28	8.90	10			
	V7-TA40	17.75	10			
	V7-EWP8	3.00	10			
	V7-GM35	3.60	10	V7-GM35	3.60	1
Marking Systems ③ Blank Tags (cards of 100) Pre-printed Tags (sticks of 10)	V7-SM8X12	12.00	5	V7-SM6X12	12.00	5
	V7-MP ④	2.70	10	V7-MP ④	2.70	10
Terminal Block Specifications						
Approvals			IEC			IEC
Voltage Rating	600V	600V	800V	600V	600V	800V
	AC/DC	AC/DC	AC/DC	AC/DC	AC/DC	AC/DC
Maximum Current	50 A	50 A	57 A	85 A	85 A	76 A
Wire Range (Rated Cross Section)	#22...	#22...	0.5...10	#14...	#14...	2.5...16
	#8 AWG	#8 AWG	mm ²	#4 AWG	#4 AWG	mm ²
Wire Strip Length	0.51" (13 mm)			0.51" (13 mm)		
Recommended Tightening Torque	12.2...13.4 lb-in. (1.4 Nm)			18...20 lb-in. (2.1 Nm)		
Density	38 pcs./ft (125/m)			27 pcs./ft (90/m)		
Insulation Temperature Range	-40°...+195°F (-40°...+90°C)			-40°...+195°F (-40°...+90°C)		
Mounting Rail	Fits all types shown on page N32			Fits all types shown on page N32		

- ① Special order with minimum quantities may be required for certain terminal colors.
- ② May only be used as a marking surface. Cannot be installed over a center jumper.
- ③ Custom marking tags available. See page N45 for full offering.
- ④ Catalog number is not complete. See pages N42...N43.

Standard Feed-Through Blocks ①

Ordering and Technical Information ①	35mm ²			70mm ²		
	Single circuit terminal block			Single circuit terminal block		
	Catalog Number	Price Ea. (Std Pkg)	Pkg. Qty	Catalog Number	Price Ea. (Std Pkg)	Pkg. Qty
Terminal - Gray	V7-W35	15	10	V7-W70	44	5
Blue	V7-W35-B	16	10	V7-W70-B	44	5
Accessories (also see pages N26 to N31)						
End Barrier	V7-EB35	2.25	25	Not Required		
End Anchors						
DIN Rail — Normal Duty	V7-EA35	1.75	50			
DIN Rail — Heavy Duty	V7-EAH35	7.00	10	V7-EAH35	7.00	10
DIN Rail — Snap-in	V7-ER35	1.80	50			
Jumpers						
Center Jumper – 3-pole	V7-CJ14-3	8.70	10			
Center Jumper – 2-pole	V7-CJ14-2	5.80	10			
Other Accessories						
Partition Plate	V7-PP35	2.50	25			
Group Marking Carrier	V7-GM35	3.60	10	V7-GM35	3.60	10
Marking Systems ②						
Blank Tags (cards of 100)	V7-SM6X12	12.00	5	V7-SM6X12	12.00	5
Pre-printed Tags (sticks of 10)	V7-MP ③	2.70	10	V7-MP ③	2.70	10
Terminal Block Specifications						
Approvals	UL	UL	IEC	UL	UL	IEC
Voltage Rating	600V AC/DC	600V AC/DC	750V AC/DC	600V AC/DC	600V AC/DC	750V AC/DC
Maximum Current	140 A	125 A	138 A	310 A	200 A	175 A
Wire Range (Rated Cross Section)	#14... #1/0 AWG	#14... #1/0 AWG	2.5...35 mm ²	#4... #3/0 AWG	#4... #3/0 AWG	4...70 mm ²
Wire Strip Length	0.67" (17 mm)			1.02" (26 mm)		
Recommended Tightening Torque	22.1lb-in. (2.5 Nm)			132.8 lb-in. (15 Nm)		
Density	21 pcs./ft (71/m)			13 pcs./ft (43/m)		
Insulation Temperature Range	-40°...+195°F (-40°...+90°C)			-40°...+195°F (-40°...+90°C)		
Mounting Rail	Fits all types shown on page N32			Fits all types shown on page N32		

① Special order with minimum quantities may be required for certain terminal colors.

② Custom marking tags available. See page N45 for full offering.

③ Catalog number is not complete. See pages N42...N43.

Specialty Feed-Through Blocks

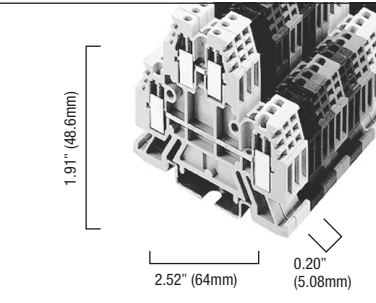
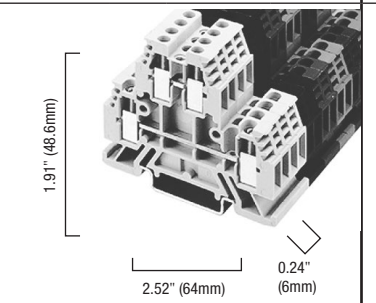
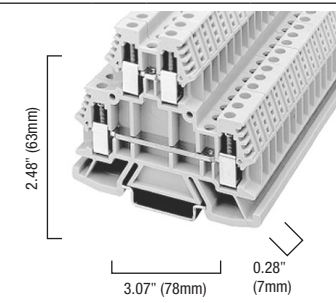
Ordering and Technical Information ①	2.5mm ²			4mm ²			6mm ²		
									
	Two circuit terminal block			Two circuit terminal block			Two circuit terminal block		
	Catalog Number	Price Ea. (Std Pkg)	Pkg. Qty	Catalog Number	Price Ea. (Std Pkg)	Pkg. Qty	Catalog Number	Price Ea. (Std Pkg)	Pkg. Qty
Terminal - Gray Blue	V7-WD3	6.50	50	V7-WD4 V7-WD4-B ①	6.00 6.20	50 50	V7-WD6	11.50	20
Accessories (also see pages N26 to N31)									
End Barrier	V7-EBD3	1.95	50	V7-EBD3	1.95	50	V7-EBD6	2.25	50
End Anchors									
DIN Rail — Normal Duty	V7-EA35	1.75	50	V7-EA35	1.75	50	V7-EA35	1.75	50
DIN Rail — Heavy Duty	V7-EAH35	7.00	10	V7-EAH35	7.00	10	V7-EAH35	7.00	10
DIN Rail — Snap-in	V7-ER35	1.80	50	V7-ER35	1.80	50	V7-ER35	1.80	50
Jumpers									
Side Jumper – 10-pole	V7-SJ5-10	3.60	10	V7-SJ6-10	4.45	10			
Center Jumper – 50-pole	V7-CJD5-50	42.00	5	V7-CJD6-50	37.00	5			
Center Jumper – 40-pole							V7-CJ7-40	37.00	5
Center Jumper – 10-pole	V7-CJD5-10	10.00	10	V7-CJD6-10	9.40	10	V7-CJ7-10	11.00	10
Center Jumper – 3-pole	V7-CJD5-3	3.80	10	V7-CJD6-3	3.50	10	V7-CJ7-3	4.10	10
Center Jumper – 2-pole	V7-CJD5-2	2.60	10	V7-CJD6-2	2.40	10	V7-CJ7-2	2.90	10
Center Jumper Link	V7-CJL5	1.35	10	V7-CJDL6	1.35	10	V7-CJL7	1.35	10
Other Accessories									
Partition Plate	V7-PPD3	2.25	50	V7-PPD3	2.25	50	V7-PPD6	2.25	50
Separation Plate	V7-SPD3	.90	50	V7-SPD3	.90	50			
Test Plug				V7-TP28	8.90	10	V7-TP28	8.90	10
Test Plug Adapter	V7-TA285	17.75	10	V7-TA40	17.75	10	V7-TA40	17.75	10
Electrical Warning Plate (1-pole)	V7-EWP5	2.25	10	V7-EWP6	2.25	10	V7-EWP7	2.25	10
Group Marking Carrier	V7-GM35	3.60	10	V7-GM35	3.60	10	V7-GM35	3.60	5
Marking Systems ②									
Blank Tags (cards of 100)	V7-SM5X9	12.00	5	V7-SM6X9	12.00	5	V7-SM6X12	12.00	5
Pre-printed Tags (sticks of 10)	V7-MP5 ③	2.70	10	V7-MP ③	2.70	10	V7-MP ③	2.70	10
Terminal Block Specifications									
Approvals	UL	UL	IEC	UL	UL	IEC	UL	UL	IEC
Voltage Rating	300V AC/DC	300V AC/DC	500V AC/DC	300V AC/DC	300V AC/DC	500V AC/DC	300V AC/DC	300V AC/DC	550V AC/DC
Maximum Current	15 A	15 A	24 A	20 A	20 A	32 A	55 A	50 A	41 A
Wire Range (Rated Cross Section)	#22... #14 AWG	#30... #14 AWG	0.5...2.5 2.5mm ²	#22... #12 AWG	#22... #10 AWG	0.5...4 4mm ²	#18... #8 AWG	#18... #8 AWG	0.5...6 mm ²
Wire Strip Length	0.39" (10 mm)			0.39" (9 mm)			0.35" (9 mm)		
Recommended Tightening Torque	5.0...5.6 lb-in. (0.6 Nm)			5.0...5.6 lb-in. (0.6 Nm)			6.2 lb-in. (0.7 Nm)		
Density	60 pcs./ft (200/m)			50 pcs./ft (166/m)			43 pcs./ft (142/m)		
Insulation Temperature Range	-40°...+195°F (-40°...+90°C)			-40°...+195°F (-40°...+90°C)			-40°...+195°F (-40°...+90°C)		
Mounting Rail	Fits all types shown on page N32			Fits all types shown on page N32			Fits all types shown on page N32		

① Special order with minimum quantities may be required for certain terminal colors.

② Custom marking tags available. See page N45 for full offering.

③ Catalog number is not complete. See pages N42...N43.

Specialty Feed-Through Blocks ①

Ordering and Technical Information ①	2.5mm ²			2.5mm ²		
	Single circuit three conductor terminal block			Single circuit terminal block with terminals on common side.		
	Catalog Number	Price Ea. (Std Pkg)	Pkg. Qty	Catalog Number	Price Ea. (Std Pkg)	Pkg. Qty
Terminal - Gray	V7-W3TW	4.70	50	V7-WR3	4.70	50
Blue	V7-W3TW-B	4.90	50			
Accessories (also see pages N26 to N31)						
End Barrier	V7-EB3TW	1.35	50	V7-EBR3	1.35	50
End Anchors						
DIN Rail — Normal Duty	V7-EA35	1.75	50	V7-EA35	1.75	50
DIN Rail — Heavy Duty	V7-EAH35	7.00	10	V7-EAH35	7.00	10
DIN Rail — Snap-in	V7-ER35	1.80	50	V7-ER35	1.80	50
Jumpers						
Side Jumper – 10-pole Insulated	V7-SJ5-10 ②	3.60	10	V7-SJ5-10	3.60	10
Center Jumper – 50-pole	V7-CJ5-50	42.00	5	V7-CJD5-50	42.00	5
Center Jumper – 10-pole	V7-CJ5-10	8.90	10	V7-CJD5-10	10.00	10
Center Jumper – 3-pole	V7-CJ5-3	3.30	10	V7-CJD5-3	3.80	10
Center Jumper – 2-pole	V7-CJ5-2	2.25	10	V7-CJD5-2	2.60	10
Center Jumper Link	V7-CJL5	1.35	10	V7-CJL5	1.35	10
Center Jumper Cover – White ③	V7-CJCW5	5.30	20	V7-CJCW5	5.30	20
Other Accessories						
Partition Plate	V7-PP10	1.80	50	V7-EBR3	1.35	50
Test Plug Adapter	V7-TA285	17.75	10	VZ-TA285	17.75	10
Electrical Warning Plate (1-pole)	V7-EWP5	2.25	10	VZ-EWP5	2.25	10
Group Marking Carrier	V7-GM35	3.60	10	V7-GM35	3.60	10
Marking Systems ④						
Blank Tags (cards of 100)	V7-SM5X9	12.00	5	V7-SM5X9	12.00	5
Pre-printed Tags (sticks of 10)	V7-MP5 ⑤	2.70	10	V7-MP5 ⑤	2.70	10
Terminal Block Specifications						
Approvals	UL	UL	IEC	UL	UL	IEC
Voltage Rating	600V AC/DC	600V AC/DC	800V AC/DC	300V AC/DC	300V AC/DC	500V AC/DC
Maximum Current	15 A	15 A	24 A	15 A	15 A	24 A
Wire Range (Rated Cross Section)	#22... #14 AWG	#30... #14 AWG	0.5...2.5 mm ²	#22... #14 AWG	#22... #14 AWG	0.5...2.5 mm ²
Wire Strip Length	0.35" (9 mm)			0.39" (10 mm)		
Recommended Tightening Torque	4.2...4.6 lb-in. (0.5 Nm)			5.0...5.6 lb-in. (0.6 Nm)		
Density	61 pcs./ft (200/m)			61 pcs./ft (200/m)		
Insulation Temperature Range	-40°...+195°F (-40°...+90°C)			-40°...+195°F (-40°...+90°C)		
Mounting Rail	Fits all types shown on page N32			Fits all types shown on page N32		

① Special order with minimum quantities may be required for certain terminal colors.







② Use side jumpers on the single conductor side only.

③ May only be used as a marking surface. Cannot be installed over a center jumper.

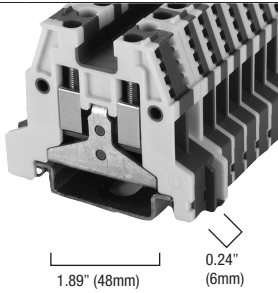
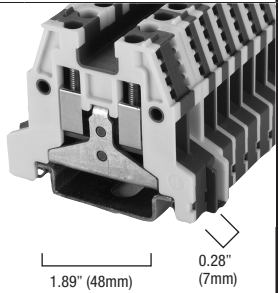
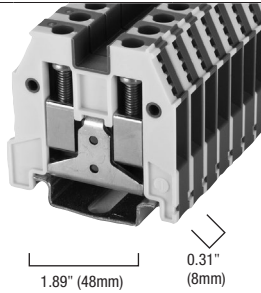
④ Custom marking tags available. See page N45 for full offering.

⑤ Catalog number is not complete. See pages N42...N43.

Grounding Blocks

Ordering and Technical Information ①	4mm ²			6mm ²			10mm ²		
									
	1.38" (35mm) 1.89" (48mm) 0.24" (6mm)			1.61" (41mm) 1.89" (48mm) 0.28" (7mm)			1.61" (41mm) 1.89" (48mm) 0.31" (8mm)		
	Single circuit grounding terminal block			Single circuit grounding terminal block			Single circuit grounding terminal block		
	Catalog Number	Price Ea. (Std Pkg)	Pkg. Qty	Catalog Number	Price Ea. (Std Pkg)	Pkg. Qty	Catalog Number	Price Ea. (Std Pkg)	Pkg. Qty
Terminal - green/yellow	V7-WG4	9.00	50	V7-WG6	9.50	50	V7-WG10S	11.50	10
Accessories (also see pages N26 to N31)									
End Barrier	V7-EB3-Y	1.95	50	V7-EB10-Y	1.50	50	V7-EB10-Y	1.50	50
End Anchors									
DIN Rail — Normal Duty	V7-EA35	1.75	50	V7-EA35	1.75	50	V7-EA35	1.75	50
DIN Rail — Heavy Duty	V7-EAH35	7.00	10	V7-EAH35	7.00	10	V7-EAH35	7.00	10
DIN Rail — Snap-in	V7-ER35	1.80	50	V7-ER35	1.80	50	V7-ER35	1.80	50
Other Accessories									
Group Marking Carrier	V7-GM35	3.60	10	V7-GM35	3.60	10	V7-GM35	3.60	10
Marking Systems ②									
Blank Tags (cards of 100)	V7-SM6X12	12.00	5	V7-SM6X12	12.00	5	V7-SM8X12	12.00	5
Pre-printed Tags (sticks of 10)	V7-MP ③	2.70	10	V7-MP ③	2.70	10			
Terminal Block Specifications									
Approvals			IEC			IEC			IEC
Voltage Rating	~	~	~	~	~	~	~	~	~
Maximum Current	Grounding			Grounding			Grounding		
Wire Range (Rated Cross Section)	#22... #14 AWG	#22... #12 AWG	4 mm ²	#22... #10 AWG	#22... #10 AWG	6 mm ²	#22... #8 AWG	#22... #8 AWG	10 mm ²
Wire Strip Length	0.43" (11 mm)			0.47" (12 mm)			0.43" (11 mm)		
Recommended Tightening Torque	5.6...6.8 lb-in. (0.7 Nm)			5.6...6.8 lb-in. (0.7 Nm)			7.1 lb-in. (0.8 Nm)		
Density	50 pcs./ft (166/m)			43 pcs./ft (142/m)			38 pcs./ft (125/m)		
Insulation Temperature Range	-40°...+195°F (-40°...+90°C)			-40°...+195°F (-40°...+90°C)			-40°...+195°F (-40°...+90°C)		
Mounting Rail	Fits all types shown on page N32			Fits all types shown on page N32			Fits all types shown on page N32		

① Refer to pages N24...N29 for a listing of all V7-W accessories.

② Custom marking tags available. See page N45 for full offering.

③ Catalog number is not complete. See pages N42...N43.

Grounding Blocks

Ordering and Technical Information ①	16mm ²			35mm ²			70mm ²		
	Single circuit grounding terminal block			Single circuit grounding terminal block			Single circuit grounding terminal block		
	Catalog Number	Price Ea. (Std Pkg)	Pkg. Qty	Catalog Number	Price Ea. (Std Pkg)	Pkg. Qty	Catalog Number	Price Ea. (Std Pkg)	Pkg. Qty
Terminal - green/yellow	V7-WG16	16.00	10	V7-WG35	21.25	10	V7-WG70	50.00	5
Accessories (also see pages N26 to N31)									
End Barrier	Not Required			Not Required			Not Required		
End Anchors									
DIN Rail — Normal Duty	Not Required			Not Required			Not Required		
DIN Rail — Heavy Duty	Not Required			Not Required			Not Required		
Other Accessories									
Group Marking Carrier	V7-GM35	3.60	10	V7-GM35	3.60	10	V7-GM35	3.60	10
Marking Systems ②									
Blank Tags (cards of 100)	V7-SM6X12	12.00	5	V7-SM6X12	12.00	5	V7-SM6X12	12.00	5
Pre-printed Tags (sticks of 10)	V7-MP ③	2.70	10	V7-MP ③	2.70	10	V7-MP ③	2.70	10
Terminal Block Specifications									
Approvals			IEC			IEC			IEC
Voltage Rating	~			~			~		
Maximum Current	Grounding			Grounding			Grounding		
Wire Range (Rated Cross Section)	#10... #4 AWG	#10... #4 AWG	16 mm ²	#6... #1/0 AWG	#6... #1/0 AWG	35 mm ²	#4... #2/0 AWG	#4... #2/0 AWG	70 mm ²
Wire Strip Length	0.70" (18 mm)			0.83" (21 mm)			1.02" (26 mm)		
Recommended Tightening Torque	22.1 lb-in. (2.5 Nm)			44.3 lb-in. (5.0 Nm)			132 lb-in. (15 Nm)		
Density	23 pcs./ft (76/m)			16 pcs./ft (55/m)			13 pcs./ft (42/m)		
Insulation Temperature Range	-40°...+195°F (-40°...+90°C)			-40°...+195°F (-40°...+90°C)			-40°...+195°F (-40°...+90°C)		
Mounting Rail	Fits all types shown on page N32			Fits all types shown on page N32			Fits all types shown on page N32		

① Refer to pages N24...N29 for a listing of all V7-W accessories.
 ② Custom marking tags available. See page N45 for full offering.
 ③ Catalog number is not complete. See pages N42...N43.

Two Level Grounding Block

Ordering and Technical Information ①			
	Two level grounding terminal block		
	Catalog Number	Price Ea. (Std Pkg)	Pkg. Qty
Terminal - green/yellow	V7-WDG4C	11.50	50
Accessories (also see pages N26 to N31)			
End Barrier	V7-EBD3-Y	1.95	50
End Anchors			
DIN Rail — Normal Duty	V7-EA35	1.75	50
DIN Rail — Heavy Duty	V7-EAH35	7.00	10
DIN Rail — Snap-in	V7-ER35	1.80	50
Jumpers			
Side Jumper - 10 pole insulated	V7-SJ6-10	4.45	10
Other Accessories			
Partition Plate	V7-PPD3	2.25	50
Group Marking Carrier	V7-GM35	3.60	10
Marking Systems ②			
Blank Tags (cards of 100)	V7-SM6X9	12.00	5
Pre-printed Tags (sticks of 10)	V7-MP ③	2.70	10
Terminal Block Specifications			
Approvals		IEC	
Voltage Rating	300V AC/DC	500V AC/DC	
Maximum Current	20A	32A	
Wire Range (Rated Cross Section)	#22...12 AWG	0.05...4mm ²	
Wire Strip Length	0.39" (10mm)		
Recommended Tightening Torque	5.0...5.6 lb-in. (0.6 Nm)		
Density	50 pcs./ft (166/m)		
Insulation Temperature Range	-40°...+195°F (-40°...90°C)		
Mounting Rail	Fits all types shown on page N32		

① Refer to pages N24...N29 for a listing of all V7-W accessories.

② Custom marking tags available. See page N45 for full offering.

③ Catalog number is not complete. See pages N42...N43.

Fuse Blocks

Ordering and Technical Information ①	4mm ²			4mm ²			4mm ²		
	Single circuit fuse block			Single circuit fuse block with LED blown fuse indication			Single circuit fuse block with neon blown fuse indication		
Terminal	Catalog Number	Price Ea. (Std Pkg)	Pkg. Qty	Catalog Number	Price Ea. (Std Pkg)	Pkg. Qty	Catalog Number	Price Ea. (Std Pkg)	Pkg. Qty
	V7-WFB4	14.00	50	V7-WFB424	26.25	50	V7-WFB4250	26.25	50
Accessories (also see pages N26 - N31)									
End Barrier	Not Required			Not Required			Not Required		
End Anchors									
DIN Rail — Normal Duty	V7-EA35	1.75	50	V7-EA35	1.75	50	V7-EA35	1.75	50
DIN Rail — Heavy Duty	V7-EAH35	7.00	10	V7-EAH35	7.00	10	V7-EAH35	7.00	10
DIN Rail — Snap-in	V7-ER35	1.80	50	V7-ER35	1.80	50	V7-ER35	1.80	50
Jumpers									
Side Jumper – 10-pole	V7-SJFB8-10	8.40	10	V7-SJFB8-10	8.40	10	V7-SJFB8-10	8.40	10
Other Accessories									
Partition Plate	V7-PPSL3	1.95	50	V7-PPSL3	1.95	50	V7-PPSL3	1.95	50
Group Marking Carrier	V7-GM35	3.60	10	V7-GM35	3.60	10	V7-GM35	3.60	10
Marking Systems ②									
Blank Tags (cards of 100)	V7-SM8X12	12.00	5	V7-SM8X12	12.00	5	V7-SM8X12	12.00	5
For Handle	V7-SM6X9	12.00	5	V7-SM6X9	12.00	5	V7-SM6X9	12.00	5
Pre-printed Tags (sticks of 10)	V7-MP ③	2.70	10	V7-MP ③	2.70	10	V7-MP ③	2.70	10
Terminal Block Specifications									
Approvals	UL	UL	IEC	UL	UL	IEC	UL	UL	IEC
Voltage Rating	300V AC/DC	300V AC/DC	500V AC/DC	300V AC/DC	300V AC/DC	500V AC/DC	300V AC/DC	300V AC/DC	500V AC/DC
Maximum Current	15 A	15 A	15 A ④	15 A	15 A	15 A ④	15 A	15 A	15 A ④
Wire Range (Rated Cross Section)	#22... #12 AWG	#22... #12 AWG	0.05...4 mm ²	#22... #12 AWG	#22... #12 AWG	0.05...4 mm ²	#22... #12 AWG	#22... #12 AWG	0.05...4 mm ²
Indicator Type	Non-Indicating			LED			Neon		
Leakage Current	~			2m A @ 24V			1m A @ 264V AC		
Working Voltage	Per Fuse Rating			10...57V AC/DC			85...264V AC		
Fuse Size (Not Supplied)	5 x 20 mm			5 x 20 mm			5 x 20 mm		
Wire Strip Length	0.31" (8mm)			0.31" (8mm)			0.31" (8mm)		
Recommended Tightening Torque	5.0...5.6 lb.-in. (0.6 Nm)			5.0...5.6 lb.-in. (0.6 Nm)			5.0...5.6 lb.-in. (0.6 Nm)		
Density	38 pcs./ft (125/m)			38 pcs./ft (125/m)			38 pcs./ft (125/m)		
Insulation Temperature Range	-40°...+195°F (-40...+90° C)			-40°...+195°F (-40...+90° C)			-40°...+195°F (-40...+90° C)		
Mounting Rail	Fits all types shown on page N32			Fits all types shown on page N32			Fits all types shown on page N32		

① Refer to pages N24...N29 for a listing of all V7-W accessories.
 ② Custom marking tags available. See page N45 for full offering.
 ③ Catalog number is not complete. See pages N42...N43.
 ④ IEC standards for 5 x 20 mm fuses do not include ratings above 6.3 A.

Fuse Blocks

Ordering and Technical Information ①	4mm ²			4mm ²			4mm ²		
	Single circuit fusible terminal block with neon blown fuse indicator			Single circuit fusible terminal block with LED blown fuse indicator			Single circuit fusible terminal block without a blown fuse indicator		
Terminal	Catalog Number	Price Ea. (Std Pkg)	Pkg. Qty	Catalog Number	Price Ea. (Std Pkg)	Pkg. Qty	Catalog Number	Price Ea. (Std Pkg)	Pkg. Qty
V7-H4	V7-H4	19.00	25	V7-H5	26.25	25	V7-H6	14.00	25
Accessories (also see pages N26 - N31)									
End Barrier	V7-N37	1.50	50	V7-N37	1.50	50	V7-N37	1.50	50
End Anchors									
DIN Rail — Normal Duty	V7-EA35	1.75	50	V7-EA35	1.75	50	V7-EA35	1.75	50
DIN Rail — Heavy Duty	V7-EAH35	7.00	10	V7-EAH35	7.00	10	V7-EAH35	7.00	10
DIN Rail — Snap-in	V7-ER35	1.80	50	V7-ER35	1.80	50	V7-ER35	1.80	50
Jumpers									
Side Jumper – 10-pole Uninsulated	V7-N49	6.10	10	V7-N49	6.10	10	V7-N49	6.10	10
Side Jumper – Insulating Sleeve	V7-SJS	2.70	10	V7-SJS	2.70	10	V7-SJS	2.70	10
Other Accessories									
Group Marking Carrier	V7-GM35	3.60	10	V7-GM35	3.60	10	V7-GM35	3.60	10
Marking Systems ②									
Blank Tags (cards of 100)	V7-SM8X12	12.00	5	V7-SM8X12	12.00	5	V7-SM8X12	12.00	5
Terminal Block Specifications									
Approvals	UL	UL	IEC	UL	UL	IEC	UL	UL	IEC
Voltage Rating	300V AC/DC	300V AC/DC	500V AC/DC	300V AC/DC	300V AC/DC	500V AC/DC	300V AC/DC	300V AC/DC	500V AC/DC
Maximum Current	12 A	12 A	12 A	12 A	12 A	12 A	12 A	12 A	12 A
Wire Range (Rated Cross Section)	#30... #12 AWG	#30... #12 AWG	0.05...2.5 mm ²	#30... #12 AWG	#30... #12 AWG	0.05...4 mm ²	#30... #12 AWG	#30... #12 AWG	0.05...4 mm ²
Indicator Type	Neon			LED			Non-Indicating		
Leakage Current	2m A @ 300V			2m A @ 24V					
Working Voltage	100...300V AC/DC			10...57V AC/DC			Per Fuse Rating		
Fuse Size (Not Supplied)	1/4" x 1-1/4"			1/4" x 1-1/4"			1/4" x 1-1/4"		
Wire Strip Length	0.38" (9.7 mm)			0.38" (9.7 mm)			0.38" (9.7 mm)		
Recommended Tightening Torque	3...7 lb.-in. (0.3...0.8 Nm)			3...7 lb.-in. (0.3...0.8 Nm)			3...7 lb.-in. (0.3...0.8 Nm)		
Density	33 pcs./ft (109/m)			33 pcs./ft (109/m)			33 pcs./ft (109/m)		
Insulation Temperature Range	-40°...+221°F (-40...+105° C)			-40°...+221°F (-40...+105° C)			-40°...+221°F (-40...+105° C)		
Mounting Rail	Fits all types shown on page N32			Fits all types shown on page N32			Fits all types shown on page N32		

① Refer to pages N24...N29 for a listing of all V7-W accessories.









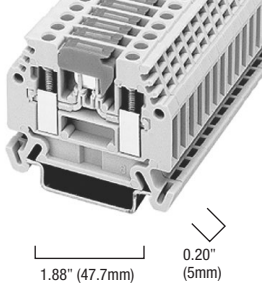
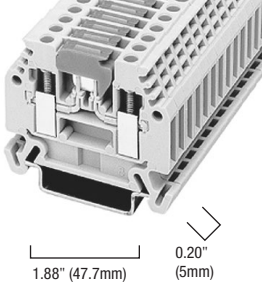
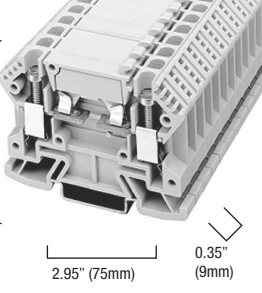

② Custom marking tags available. See page N45 for full offering.



Fuse Blocks

Ordering and Technical Information ①	4mm ²			4mm ²		
	Single circuit fuse block			Single circuit fuse block		
	Catalog Number	Price Ea. (Std Pkg)	Pkg. Qty	Catalog Number	Price Ea. (Std Pkg)	Pkg. Qty
Terminal	V7-WFB10V	16.75	25	V7-WFB10VA	16.75	25
Accessories (also see pages N26 to N31)						
End Barrier	V7-EBFB10V	1.95	50	V7-EBFB10V	1.95	50
End Anchors						
DIN Rail — Normal Duty	V7-EA35	1.75	50	V7-EA35	1.75	50
DIN Rail — Heavy Duty	V7-EAH35	7.00	10	V7-EAH35	7.00	10
DIN Rail — Snap-in	V7-ER35	1.80	50	V7-ER35	1.80	50
Other Accessories						
Replacement Fuse Knob	V7-FCA	5.25	5	V7-FCA	5.25	5
Group Marking Carrier	V7-GM35	3.60	10	V7-GM35	3.60	10
Marking Systems ②						
Blank Tags (cards of 100)	V7-SM6X12	12.00	5	V7-SM6X12	12.00	5
Pre-printed Tags (sticks of 10)	V7-MP ③	2.70	10	V7-MP ③	2.70	10
Terminal Block Specifications						
Approvals	cULus	IEC	cULus	IEC		
Voltage Rating	300V AC/DC	250V AC/DC	300V AC/DC	250V AC/DC		
Maximum Current	10 A	10 A	10 A	10 A		
Wire Range (Rated Cross Section)	#20...8 AWG	10mm ²	#20...8 AWG	10mm ²		
Indicator Type	Non-Indicating		Non-Indicating			
Leakage Current	~		~			
Working Voltage	Per Fuse Rating		Per Fuse Rating			
Fuse Size (Not Supplied)	5 x 20 mm		1/4 in. x 1-1/4 in. (6.3 x 32mm)			
Wire Strip Length	0.51" (13 mm)		0.51" (13 mm)			
Recommended Tightening Torque	13 lb-in. (1.5 Nm)		13 lb-in. (1.5 Nm)			
Density	23 pcs./ft (75/m)		23 pcs./ft (75/m)			
Insulation Temperature Range	-40°...+195°F (-40°...+90°C)		-40°...+195°F (-40°...+90°C)			
Mounting Rail	Fits all types shown on page N32		Fits all types shown on page N32			

① Refer to pages N24...N29 for a listing of all V7-W accessories.
 ② Custom marking tags available. See page N45 for full offering.
 ③ Catalog number is not complete. See pages N42...N43.

Isolation Blocks

Ordering and Technical Information 	2.5mm ²			2.5mm ²			6mm ²		
									
	Knife style isolating terminal block			Knife style isolating terminal block with test plug screws			Knife style isolating terminal block		
	Catalog Number	Price Ea. (Std Pkg)	Pkg. Qty	Catalog Number	Price Ea. (Std Pkg)	Pkg. Qty	Catalog Number	Price Ea. (Std Pkg)	Pkg. Qty
Terminal - Gray	V7-WKD3	7.90	50	V7-WKD3TP	9.70	50	V7-WKD6	21.25	20
Accessories (also see pages N26 to N31)									
End Barrier	V7-EBKD3	1.20	50	V7-EBKD3	1.20	50	Not Required		
End Anchors									
DIN Rail — Normal Duty	V7-EA35	1.75	50	V7-EA35	1.75	50	V7-EA35	1.75	50
DIN Rail — Heavy Duty	V7-EAH35	7.00	10	V7-EAH35	7.00	10	V7-EAH35	7.00	10
DIN Rail — Snap-in	V7-ER35	1.80	50	V7-ER35	1.80	50	V7-ER35	1.80	50
Jumpers									
Side jumper - 10-pole insulated	V7-SJ5-10	3.60	10	V7-SJ5-10	3.60	10			
Other Accessories									
Partition Plate	V7-PPSL3	1.95	50	V7-PPSL3	1.95	50			
Test Plug				V7-TP15	17.75	10			
Group Marking Carrier	V7-GM35	3.60	10	V7-GM35	3.60	10	V7-GM35	3.60	10
Marking Systems 									
Blank Tags (cards of 100)	V7-SM5X9	12.00	5	V7-SM5X9	12.00	5	V7-SM6X12	12.00	5
Pre-printed Tags (sticks of 10)	V7-MP5 	2.70	10	V7-MP5 	2.70	10	V7-MP5 	2.70	10
Terminal Block Specifications									
Approvals			IEC			IEC			IEC
Voltage Rating	600V AC/DC	600V AC/DC	800V AC/DC	300V AC/DC	300V AC/DC	800V AC/DC	600V AC/DC	600V AC/DC	800V AC/DC
Maximum Current	15A	15A	15A	15A	15A	15A	30A	30A	32A
Wire Range (Rated Cross Section)	#22... #14 AWG	#22... #14 AWG	0.5...2.5 mm ²	#22... #14 AWG	#22... #14 AWG	0.5...2.5 mm ²	#18... #10 AWG	#18... #10 AWG	0.5...6 mm ²
Wire Strip Length	0.35" (9 mm)			0.35" (9 mm)			0.55" (14 mm)		
Recommended Tightening Torque	5.0...5.6 lb-in. (0.6 Nm)			5.0...5.6 lb-in. (0.6 Nm)			7.1 lb-in. (0.8 Nm)		
Density	61 pcs./ft (200/m)			61 pcs./ft (200/m)			33 pcs./ft (111/m)		
Insulation Temperature Range	-40°...+195°F (-40°...+90°C)			-40°...+195°F (-40°...+90°C)			-40°...+195°F (-40°...+90°C)		
Mounting Rail	Fits all types shown on page N32			Fits all types shown on page N32			Fits all types shown on page N32		

 Refer to pages N24-29 for a listing of all V7-W accessories.
 Custom marking tags available. See page N45 for full offering.
 Catalog number is not complete. See pages N42...N43.

Isolation Blocks

Ordering and Technical Information 1	4mm²		
	Handle style isolating terminal block		
	Catalog Number	Price Ea. (Std Pkg)	Pkg. Qty
Terminal - Black	V7-H7	15.25	25
Accessories (also see pages N26 to N31)			
End Barrier	V7-N37	1.50	50
End Anchors			
DIN Rail — Normal Duty	V7-EA35	1.75	50
DIN Rail — Heavy Duty	V7-EAH35	7.00	10
DIN Rail — Snap-in	V7-ER35	1.80	50
Jumpers			
Side Jumper - 10 pole Uninsulated	V7-N49	6.10	10
Side Jumper - Insulating Sleeve	V7-SJS	2.70	10
Other Accessories			
Group Marking Carrier	V7-GM35	3.60	10
Marking Systems 2			
Blank Tags (cards of 100)	V7-SM8X12	12.00	5
Terminal Block Specifications			
Approvals			IEC
Voltage Rating	300V AC/DC	300V AC/DC	500V AC/DC
Maximum Current	15A	15A	15A
Wire Range (Rated Cross Section)	#30... 12 AWG	#30... 12 AWG	0.5...4 mm ²
Wire Strip Length	0.38" (9.7mm)		
Recommended Tightening Torque	3...7 lb-in. (0.3...0.8 Nm)		
Density	33 pcs./ft (109/m)		
Insulation Temperature Range	-40°...+221°F (-40°...105°C)		
Mounting Rail	Fits all types shown on page N32		

1 Refer to pages N24-29 for a listing of all V7-W accessories.
 2 Custom marking tags available. See page N45 for full offering.

Sensor Blocks

Ordering and Technical Information ❶	2.5mm ²			2.5mm ²			2.5mm ²		
	Three circuit terminal block			Three circuit terminal block with LED indicator for PNP devices			Three circuit terminal block with LED indicator for NPN devices		
Terminal - Gray	Catalog Number	Price Ea. (Std Pkg)	Pkg. Qty	Catalog Number	Price Ea. (Std Pkg)	Pkg. Qty	Catalog Number	Price Ea. (Std Pkg)	Pkg. Qty
	V7-WTF3	9.90	50	V7-WTF3LP ❶	20.50	50	V7-WTF3LN ❶	20.50	50
Accessories (also see pages N26 - N31)									
End Barrier	V7-EBTF3	1.95	50	V7-EBTF3	1.95	50	V7-EBTF3	1.95	50
End Anchors									
DIN Rail — Normal Duty	V7-EA35	1.75	50	V7-EA35	1.75	50	V7-EA35	1.75	50
DIN Rail — Heavy Duty	V7-EAH35	7.00	10	V7-EAH35	7.00	10	V7-EAH35	7.00	10
DIN Rail — Snap-in	V7-ER35	1.80	50	V7-ER35	1.80	50	V7-ER35	1.80	50
Jumpers									
Side Jumper – 20-pole Insulated - Red	V7-SJT5-20-R	10.50	10	V7-SJT5-20-R	10.50	10	V7-SJT5-20-R	10.50	10
Side Jumper – 20-pole Insulated - Blue	V7-SJT5-20-B	10.50	10	V7-SJT5-20-B	10.50	10	V7-SJT5-20-B	10.50	10
Center Jumper – 50-pole	V7-CJT5-50	42.00	5	V7-CJT5-50	42.00	5	V7-CJT5-50	42.00	5
Center Jumper – 10-pole	V7-CJT5-10	10.00	10	V7-CJT5-10	10.00	10	V7-CJT5-10	10.00	10
Center Jumper Link	V7-CJL5	1.35	10	V7-CJL5	1.35	10	V7-CJL5	1.35	10
Other Accessories									
Partition Plate	V7-PPTS3	1.25	50	V7-PPTS3	1.25	50	V7-PPTS3	1.25	50
Test Plug Adaptor	V7-TA285	17.75	10	V7-TA285	17.75	10	V7-TA285	17.75	10
Electrical Warning Plate (1-pole)	V7-EWP5	2.25	10	V7-EWP5	2.25	10	V7-EWP5	2.25	10
Group Marking Carrier	V7-GM35	3.60	10	V7-GM35	3.60	10	V7-GM35	3.60	10
Marking Systems ❷									
Blank Tags (cards of 100) ❸	V7-SM5X9	12.00	5	V7-SM5X9	12.00	5	V7-SM5X9	12.00	5
Pre-printed Tags (sticks of 10)	V7-MP5 ❸	2.70	10	V7-MP5 ❸	2.70	10	V7-MP5 ❸	2.70	10
Terminal Block Specifications									
Approvals	UL	UL	IEC	UL	UL	IEC	UL	UL	IEC
Voltage Rating	300V	300V	250V AC/DC	300V AC/DC	300V AC/DC	250V AC/DC	50V AC/DC	50V AC/DC	250V AC/DC
Maximum Current	10 A	10 A	24 A	10 A	10 A	24 A	10 A	10 A	24 A
Wire Range (Rated Cross Section)	#26... #14 AWG	#26... #14 AWG	0.5...2.5 mm ²	#26... #14 AWG	#26... #14 AWG	0.5...2.5 mm ²	#26... #14 AWG	#26... #14 AWG	0.5...2.5 mm ²
Leakage Current				2.69mA @ 50V			2.69mA @ 50V		
Wire Strip Length	0.31" (8 mm)			0.31" (8 mm)			0.31" (8 mm)		
Recommended Tightening Torque	4.2...4.6 lb-in. (0.5 Nm)			4.2...4.6 lb-in. (0.5 Nm)			4.2...4.6 lb-in. (0.5 Nm)		
Density	60 pcs./ft (197/m)			60 pcs./ft (197/m)			60 pcs./ft (197/m)		
Insulation Temperature Range	-40°...+195°F (-40°...+90°C)			-40°...+195°F (-40°...+90°C)			-40°...+195°F (-40°...+90°C)		
Mounting Rail	Fits all types shown on page N32			Fits all types shown on page N32			Fits all types shown on page N32		
Wiring Diagram	See page N35								

❶ May require special order with minimum quantities.
 ❷ Custom marking tags available. See page N45 for full offering.
 ❸ Catalog number is not complete. See pages N42...N43.

Sensor Blocks

Ordering and Technical Information ❶	2.5mm ²			2.5mm ²			2.5mm ²		
	Three level sensor block			Three level sensor block LED indicator for PNP devices			Three level sensor block LED indicator for NPN devices		
	Catalog Number	Price Ea. (Std Pkg)	Pkg. Qty	Catalog Number	Price Ea. (Std Pkg)	Pkg. Qty	Catalog Number	Price Ea. (Std Pkg)	Pkg. Qty
Terminal - Gray	V7-WTS3	9.40	50	V7-WTS3LP ❶	20.00	50	V7-WTS3LN ❶	20.50	50
Accessories (also see pages N26 - N31)									
End Barrier	V7-EBTS3	1.95	50	V7-EBTS3	1.95	50	V7-EBTS3	1.95	50
End Anchors									
DIN Rail — Normal Duty	V7-EA35	1.75	50	V7-EA35	1.75	50	V7-EA35	1.75	50
DIN Rail — Heavy Duty	V7-EAH35	7.00	10	V7-EAH35	7.00	10	V7-EAH35	7.00	10
DIN Rail — Snap-in	V7-ER35	1.80	50	V7-ER35	1.80	50	V7-ER35	1.80	50
Jumpers									
Side Jumper – 20-pole Insulated - Red	V7-SJT5-20-R	10.50	10	V7-SJT5-20-R	10.50	10	V7-SJT5-20-R	10.50	10
Side Jumper – 20-pole Insulated - Blue	V7-SJT5-20-B	10.50	10	V7-SJT5-20-B	10.50	10	V7-SJT5-20-B	10.50	10
Center Jumper – 50-pole	V7-CJT5-50	42.00	5	V7-CJT5-50	42.00	5	V7-CJT5-50	42.00	5
Center Jumper – 10-pole	V7-CJT5-10	10.00	10	V7-CJT5-10	10.00	10	V7-CJT5-10	10.00	10
Center Jumper Link	V7-CJL5	1.35	10	V7-CJL5	1.35	10	V7-CJL5	1.35	10
Other Accessories									
Partition Plate	V7-PPTS3	1.25	50	V7-PPTS3	1.25	50	V7-PPTS3	1.25	50
Test Plug Adapter	V7-TA285	17.75	10	V7-TA285	17.75	10	V7-TA285	17.75	10
Electrical Warning Plate (1-pole)	V7-EWP5	2.25	10	V7-EWP5	2.25	10	V7-EWP5	2.25	10
Group Marking Carrier	V7-GM35	3.60	10	V7-GM35	3.60	10	V7-GM35	3.60	10
Marking Systems ❷									
Blank Tags (cards of 100) ❸	V7-SM5X9	12.00	5	V7-SM5X9	12.00	5	V7-SM5X9	12.00	5
Pre-printed Tags (sticks of 10)	V7-MP5 ❸	2.70	10	V7-MP5 ❸	2.70	10	V7-MP5 ❸	2.70	10
Terminal Block Specifications									
Approvals			IEC			IEC			IEC
Voltage Rating	300V	300V	250V AC/DC	300V AC/DC	300V AC/DC	250V AC/DC	300V AC/DC	300V AC/DC	250V AC/DC
Maximum Current	10 A	10 A	24 A	10 A	10 A	24 A	10 A	10 A	24 A
Wire Range (Rated Cross Section)	#26... #14 AWG	#26... #14 AWG	0.5...2.5 mm ²	#26... #14 AWG	#26... #14 AWG	0.5...2.5 mm ²	#26... #14 AWG	#26... #14 AWG	0.5...2.5 mm ²
Leakage Current	2.69mA @ 50V			2.69mA @ 50V			2.69mA @ 50V		
Wire Strip Length	0.31" (8 mm)			0.31" (8 mm)			0.31" (8 mm)		
Recommended Tightening Torque	4.2...4.6 lb-in. (0.5 Nm)			4.2...4.6 lb-in. (0.5 Nm)			4.2...4.6 lb-in. (0.5 Nm)		
Density	60 pcs./ft (197/m)			60 pcs./ft (197/m)			60 pcs./ft (197/m)		
Insulation Temperature Range	-40°...+195°F (-40°...+90°C)			-40°...+195°F (-40°...+90°C)			-40°...+195°F (-40°...+90°C)		
Mounting Rail	Fits all types shown on page N32			Fits all types shown on page N32			Fits all types shown on page N32		
Wiring Diagram	See page N35								

- ❶ May require special order with minimum quantities.
- ❷ Custom marking tags available. See page N45 for full offering.
- ❸ Catalog number is not complete. See pages N42...N43.

Plug-in Style Blocks

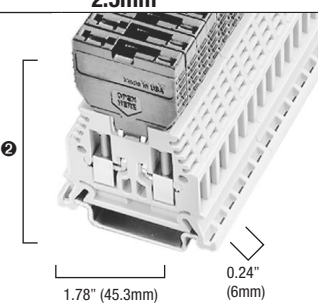
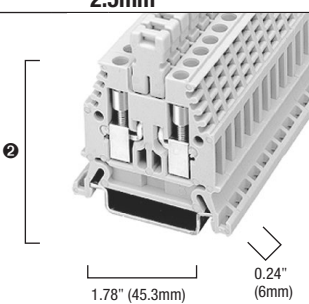
Ordering and Technical Information ^①	2.5mm ²			2.5mm ²		
						
	Pluggable terminal block			Pluggable terminal block with test plug screws		
	Catalog Number	Price Ea. (Std Pkg)	Pkg. Qty	Catalog Number	Price Ea. (Std Pkg)	Pkg. Qty
Terminal - Gray	V7-W4P	5.30	50	V7-W4PTP	7.00	50
Inserts						
Disconnect Plug	V7-DP4	2.70	50	V7-DP4 (shown)	2.70	50
Component Plug	V7-CP4 ^{②③}	7.40	50	V7-CP4 ^②	7.40	50
Fuse Plug	V7-FP4 ^② (shown)	11.00	50	V7-FP4 ^{②④}	11.00	50
Fuse Plug w/LED Blown Fuse Indication	V7-FP424 ^{②④}	22.00	50	V7-FP424 ^{②④}	22.00	50
Fuse Plug w/LED Blown Fuse Indication	V7-FP4250 ^{②④}	22.00	50	V7-FP4250 ^{②④}	22.00	50
Accessories (also see pages N26 to N31)						
End Barrier	V7-EB3	1.20	50	V7-EB3	1.20	50
End Anchors						
DIN Rail — Normal Duty	V7-EA35	1.75	50	V7-EA35	1.75	50
DIN Rail — Heavy Duty	V7-EAH35	7.00	10	V7-EAH35	7.00	10
DIN Rail — Snap-in	V7-ER35	1.80	50	V7-ER35	1.80	50
Jumpers						
Side Jumper — 10-pole Insulated	V7-SJ6-10	4.45	10	V7-SJ6-10	4.45	10
Other Accessories						
Partition Plate	V7-PP3	1.50	50	V7-PP3	1.50	50
Test Plug				V7-TP23	8.90	50
Group Marking Carrier	V7-GM35	3.60	10	V7-GM35	3.60	10
Marking Systems ^⑤						
Blank Tags (cards of 100)	V7-SM6X12	12.00	5	V7-SM6X12	12.00	5
Pre-printed Tags (sticks of 10)	V7-MP ^⑦	2.70	10	V7-MP ^⑦	2.70	10
Terminal Block Specifications						
Approvals			IEC			IEC
Voltage Rating	600V AC/DC	600V AC/DC	800V AC/DC	600V AC/DC	600V AC/DC	800V AC/DC
Maximum Current	20 A	20 A	32 A	20 A	20 A	32 A
Wire Range (Rated Cross Section)	#22... #12 AWG	#22... #12 AWG	0.5...2.5 mm ²	#22... #12 AWG	#22... #12 AWG	0.5...2.5 mm ²
Wire Strip Length	0.35" (9mm)			0.35" (9mm)		
Recommended Tightening Torque	5.0...5.6 lb-in. (0.6 Nm)			5.0...5.6 lb-in. (0.6 Nm)		
Density	50 pcs./ft (166/m)			50 pcs./ft (166/m)		
Insulation Temperature Range	-40°...+195°F (-40°...+90°C)			-40°...+195°F (-40°...+90°C)		
Mounting Rail	Fits all types shown on page N32			Fits all types shown on page N32		

- ① Refer to pages N24...N29 for a listing of all V7-W accessories.
- ② Overall height varies with plug-in component. For V7-DP4, use 2.5" (63.5 mm); for V7-CP4, use 2.9" (74 mm); and for V7-FP4..., use 3.1" (78 mm).
- ③ Maximum current and voltage rating of component plug is 1A @ 600V. Maximum current rating for the base terminal block is listed under Specifications.
- ④ Maximum current and voltage ratings for the fuse plug are 10A and 250V. Maximum ratings for the base blocks are listed under Specifications.
- ⑤ See page N32 for Fuse Plug Specifications.
- ⑥ Custom marking tags available. See page N45 for full offering.
- ⑦ Catalog number is not complete. See pages N42...N43.

Multi-level Plug-in Style Blocks

Ordering and Technical Information ①	2.5mm ²			2.5mm ²		
	Two level terminal block with top level capable of accepting plug-in components and lower level acting as an independent feed-through circuit			Three level terminal block with top level capable of accepting plug-in components second level acting as an independent feed-through circuit, and third level acting as a grounding circuit		
	Catalog Number	Price Ea. (Std Pkg)	Pkg. Qty	Catalog Number	Price Ea. (Std Pkg)	Pkg. Qty
Terminal - Gray	V7-WD4P	10.00	50	V7-WDG4P	13.50	50
Inserts						
Disconnect Plug	V7-DP4 (shown)	2.70	50	V7-DP4 (shown)	2.70	50
Component Plug	V7-CP4 ④	7.40	50	V7-CP4 ④	7.40	50
Fuse Plug	V7-FP4 ④⑤	11.00	50	V7-FP4 ④⑤	11.00	50
Fuse Plug w/LED Blown Fuse Indication	V7-FP424 ④⑤	22.00	50	V7-FP424 ④⑤	22.00	50
Fuse Plug w/LED Blown Fuse Indication	V7-FP4250 ④⑤	22.00	50	V7-FP4250 ④⑤	22.00	50
Accessories (also see pages N26 - N31)						
End Barrier	V7-EBD4P	2.00	50	V7-EBD4P	2.00	50
End Anchors						
DIN Rail — Normal Duty	V7-EA35	1.75	50	V7-EA35	1.75	50
DIN Rail — Heavy Duty	V7-EAH35	7.00	10	V7-EAH35	7.00	10
DIN Rail — Snap-in	V7-ER35	1.80	50	V7-ER35	1.80	50
Jumpers						
Side Jumper – 10-pole Insulated	V7-SJ6-10	4.45	10	V7-SJ6-10	4.45	10
Center Jumper – 50-pole	V7-CJD6-50	37.00	5	V7-CJD6-50	37.00	5
Center Jumper – 10-pole	V7-CJD6-10	9.40	10	V7-CJD6-10	9.40	10
Center Jumper – 3-pole	V7-CJD6-3	3.50	10	V7-CJD6-3	3.50	10
Center Jumper – 2-pole	V7-CJD6-2	2.40	10	V7-CJD6-2	2.40	10
Center Jumper Link	V7-CJDL6	1.35	10	V7-CJDL6	1.35	10
Other Accessories						
Test Plug	V7-TP28	8.90	10	V7-TP28	8.90	10
Test Plug Adapter	V7-TA40	17.75	10	V7-TA40	17.75	10
Group Marking Carrier	V7-GM35	3.60	10	V7-GM35	3.60	10
Marking Systems ⑥						
Blank Tags (cards of 100)	V7-SM6X9	12.00	5	V7-SM6X9	12.00	5
Pre-printed Tags (sticks of 10)	V7-MP ⑦	2.70	10	V7-MP ⑦	2.70	10
Terminal Block Specifications						
Approvals			IEC			IEC
Voltage Rating	300V AC/DC	300V AC/DC	500V AC/DC	300V AC/DC	300V AC/DC	500V AC/DC
Maximum Current	15 A	15 A	20 A	15 A	15 A	20 A
Wire Range (Rated Cross Section)	#22... #12 AWG	#22... #12 AWG	0.5...2.5 mm ²	#22... #12 AWG	#22... #12 AWG	0.5...2.5 mm ²
Wire Strip Length	0.31" (8mm)			0.31" (8mm)		
Recommended Tightening Torque	5.0...5.6 lb-in. (0.6 Nm)			5.0...5.6 lb-in. (0.6 Nm)		
Density	50 pcs./ft (166/m)			50 pcs./ft (166/m)		
Insulation Temperature Range	-40°...+195°F (-40°...+90°C)			-40°...+195°F (-40°...+90°C)		
Mounting Rail	Fits all types shown on page N32			Fits all types shown on page N32		

① Refer to pages N24...N29 for a listing of all V7-W accessories.
 ② Overall height varies with plug-in component. For V7-DP4, use 2.5" (63.5 mm); for V7-CP4, use 2.9" (74 mm); and for V7-FP4..., use 3.1" (78 mm).
 ③ Maximum current and voltage rating of component plug is 1A @ 600V. Maximum current rating for the base terminal block is listed under Specifications.

④ Maximum current and voltage ratings for the fuse plug are 10A and 250V. Maximum ratings for the base blocks are listed under Specifications.
 ⑤ See page N32 for Fuse Plug Specifications.
 ⑥ Custom marking tags available. See page N45 for full offering.
 ⑦ Catalog number is not complete. See pages N42...N43.

Component Blocks

Ordering and Technical Information ❶	4mm ²			4mm ²			4mm ²		
	Two level block with a commoning bar between the upper and lower levels, providing multiple outlets			Two level block with a diode in forward bias between the upper and lower levels			Two level block with a diode in reverse bias between the upper and lower levels		
	Catalog Number	Price Ea. (Std Pkg)	Pkg. Qty	Catalog Number	Price Ea. (Std Pkg)	Pkg. Qty	Catalog Number	Price Ea. (Std Pkg)	Pkg. Qty
Terminal - Gray	V7-WD4C	10.50	50	V7-WD4DF ❶	13.00	1	V7-WD4DR ❶	13.00	1
Accessories (also see pages N26 - N31)									
End Barrier	V7-EBD3	1.95	50	V7-EBD3	1.95	50	V7-EBD3	1.95	50
End Anchors									
DIN Rail — Normal Duty	V7-EA35	1.75	50	V7-EA35	1.75	50	V7-EA35	1.75	50
DIN Rail — Heavy Duty	V7-EAH35	7.00	10	V7-EAH35	7.00	10	V7-EAH35	7.00	10
DIN Rail — Snap-in	V7-ER35	1.80	50	V7-ER35	1.80	50	V7-ER35	1.80	50
Jumpers									
Side Jumper — 10-pole Insulated	V7-SJ6-10	4.45	10	V7-SJ6-10	4.45	10	V7-SJ6-10	4.45	10
Center Jumper — 50-pole	V7-CJD6-50	37.00	5	V7-CJD6-50	37.00	5	V7-CJD6-50	37.00	5
Center Jumper — 10-pole	V7-CJD6-10	9.40	10	V7-CJD6-10	9.40	10	V7-CJD6-10	9.40	10
Center Jumper — 3-pole	V7-CJD6-3	3.50	10	V7-CJD6-3	3.50	10	V7-CJD6-3	3.50	10
Center Jumper — 2-pole	V7-CJD6-2	2.40	10	V7-CJD6-2	2.40	10	V7-CJD6-2	2.40	10
Center Jumper Link	V7-CJDL6	1.35	10	V7-CJDL6	1.35	10	V7-CJDL6	1.35	10
Other Accessories									
Partition Plate	V7-PPD3	2.25	50	V7-PPD3	2.25	50	V7-PPD3	2.25	50
Separation Plate	V7-SPD3	.90	10	V7-SPD3	.90	10	V7-SPD3	.90	10
Test Plug	V7-TP28	8.90	10	V7-TP28	8.90	10	V7-TP28	8.90	10
Test Plug Adapter	V7-TA40	17.75	10	V7-TA40	17.75	10	V7-TA40	17.75	10
Group Marking Carrier	V7-GM35	3.60	10	V7-GM35	3.60	10	V7-GM35	3.60	10
Marking Systems ❷									
Blank Tags (cards of 100)	V7-SM6X9	12.00	5	V7-SM6X9	12.00	5	V7-SM6X9	12.00	5
Pre-printed Tags (sticks of 10)	V7-MP ❸	2.70	10	V7-MP ❸	2.70	10	V7-MP ❸	2.70	10
Terminal Block Specifications									
Approvals	UL	UL	IEC	UL	UL	IEC	UL	UL	IEC
Voltage Rating	300V AC/DC	300V AC/DC	500V AC/DC	300V AC/DC	300V AC/DC	500V AC/DC	300V AC/DC	300V AC/DC	500V AC/DC
Maximum Current	20 A	20 A	32 A	1 A (Diode)	1 A (Diode)	1 A (Diode)	1 A (Diode)	1 A (Diode)	1 A (Diode)
Wire Range (Rated Cross Section)	#22... #12 AWG	#22... #12 AWG	0.05...4 mm ²	#22... #12 AWG	#22... #12 AWG	0.05...4 mm ²	#22... #12 AWG	#22... #12 AWG	0.05...4 mm ²
Working Voltage				Diode 1N4007 ❹			Diode 1N4007 ❹		
Wire Strip Length	0.39" (10mm)			0.39" (10mm)			0.39" (10mm)		
Recommended Tightening Torque	5.0...5.6 lb-in. (0.6 Nm)			5.0...5.6 lb-in. (0.6 Nm)			5.0...5.6 lb-in. (0.6 Nm)		
Density	50 pcs./ft (166/m)			50 pcs./ft (166/m)			50 pcs./ft (166/m)		
Insulation Temperature Range	-40°...+195°F (-40°...+90°C)			-40°...+195°F (-40°...+90°C)			-40°...+195°F (-40°...+90°C)		
Mounting Rail	Fits all types shown on page N32			Fits all types shown on page N32			Fits all types shown on page N32		
Schematics									
Diode Block									
Uses a 1N4007 diode between the upper and lower levels for insertion into a control circuit. This block is useful in low voltage DC control circuits for directioning and suppression.									

❶ May require special order with minimum quantities.

❷ Custom marking tags available. See page N45 for full offering.

❹ Catalog number is not complete. See pages N42...N43.



❸ See page N31 for Component Specifications.

Thermocouple Blocks ①

Ordering and Technical Information ①	2.5mm²			
	Two-pole thermocouple block			
		Catalog Number	Price Ea. (Std Pkg)	Pkg. Qty
Current Bar Material				
Pos. Leg / Neg. Leg	Trade Name			
NiCr / CuNi	Chromel / Constantan	V7-WTC3E	16.00	10
Ir / CuNi	Iron / Constantan	V7-WTC3J	16.00	10
Cu / CuNi	Copper / Constantan	V7-WTC3T	16.00	10
Accessories (also see pages N26 to N31)				
End Barrier		V7-EB3	1.20	50
End Anchors				
DIN Rail — Normal Duty		V7-EA35	1.75	50
DIN Rail — Heavy Duty		V7-EAH35	7.00	10
DIN Rail — Snap-in		V7-ER35	1.80	50
Other Accessories				
Partition Plate		V7-PP3	1.50	
Group Marking Carrier		V7-GM35	3.60	10
Marking Systems ②				
Blank Tags (cards of 100) ②		V7-SM5X9	12.00	5
Pre-printed Tags (sticks of 10)		V7-MP5 ③	2.70	10
Terminal Block Specifications				
Approvals				
Wire Range (Rated Cross Section)		0.28...#14 AWG 0.2...2.5 mm ²		
Wire Strip Length		0.35" (10mm)		
Recommended Tightening Torque		5.0...5.6 lb-in. (0.6 Nm)		
Density		30 pcs./ft (100/m)		
Insulation Temperature Range		-40°...+195°F (-40°...105°C)		
Mounting Rail		Fits all types shown on page N32		



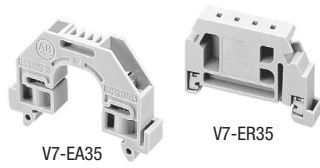
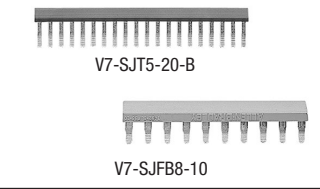

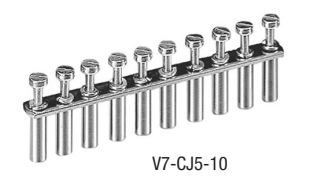
- ① May require special order with minimum quantities.
- ② Custom marking tags available. See page N45 for full offering.
- ③ Catalog number is not complete. See pages N42...N43.

Accessories

Component	Description	Type	Catalog Number	Price Each	Std. Pkg.	pg. N5	pg. N5	pg. N5	pg. N6	pg. N6
						-W3 Through	-W4 Through	-W6 Through	-W10 Through	-W16S Through
 <p>V7-EB3 V7-EB35 V7-N37</p>	End Barrier Provides insulation for the last terminal block in a group. Gray unless noted.		V7-EB10	1.20	50					
		(shown)	V7-EB3	1.20	50	■	■			
			V7-EB3TW	1.35	50					
		(shown)	V7-EB35	2.25	25					
			V7-EBD3	1.95	50					
		yellow	V7-EBD3-Y	1.95	50					
			V7-EBD6	2.25	50					
			V7-EBD4P	2.00	50					
			V7-EBKD3	1.20	50					
			V7-EBR3	1.35	50					
			V7-EBTF3	1.95	50					
		(shown)	V7-EBTS3	1.95	50					
			V7-N37	1.50	50					
	yellow	V7-EB10-Y	1.50	50						
	yellow	V7-EB3-Y	1.20	50						
			V7-EBFB10V	1.45	50					
 <p>V7-EA35 V7-ER35</p>	End Anchor (Screw type) Anchors a row of blocks or a single block	Standard (shown)	V7-EA35	1.75	50	■	■	■	■	■
		Heavy Duty	V7-EAH35	7.00	10	■	■	■	■	■
		Snap In (shown)	V7-ER35	1.80	50	■	■	■	■	■
 <p>V7-SJT5-20-B V7-SJFB8-10</p>	Side Jumpers Insulated, fit in wire openings of blocks		V7-SJ5-10	3.60	10	■				
			V7-SJ6-10	4.45	10		■			
			V7-SJ8-10	5.10	10				■	
		(shown)	V7-SJFB8-10	8.40	10					
		Blue	V7-SJT5-20-B	10.50	10					
		Red	V7-SJT5-20-R	10.50	10					
	Non-insulated	V7-N49	6.10	10						
 <p>V7-SJS</p>	Insulating Side Jumper Sleeve For use with catalog # V7-N49		V7-SJS	2.70	10					
	Replacement Fuse Knob		V7-FCM	5.25	50					
 <p>V7-CJ5-10</p>	Center Jumpers Uninsulated, screw into threaded hole in center of block (See page N28 for more Center Jumpers)	2 pole	V7-CJ5-2	2.25	10	■				
		3 pole	V7-CJ5-3	3.30	10	■				
		10 pole	V7-CJ5-10	8.90	10	■				
		50 pole	V7-CJ5-50	42.00	5	■				
		2 pole	V7-CJ6-2	2.40	10		■			
		3 pole	V7-CJ6-3	3.50	10		■			
		10 pole	V7-CJ6-10	9.40	10		■			
50 pole	V7-CJ6-50	37.00	5		■					

Note: For full line of marking accessories see the Marking Section beginning on page N38.

Accessories (Continued)







Component	Description	Type	Catalog Number	Price Each	Std. Pkg.	Terminal Block Configuration				
						-W3 Through	-W4 Through	-W6 Through	-W10 Through	-W16S Through
 <p>Center Jumpers Uninsulated, screw into threaded hole in center of block</p>		2 pole	V7-CJ7-2	2.90	10					
		3 pole	V7-CJ7-3	4.10	10			■		
		10 pole	V7-CJ7-10	11.00	10			■		
		40 pole	V7-CJ7-40	37.00	5			■		
		2 pole	V7-CJ8-2	3.10	10				■	
		3 pole	V7-CJ8-3	4.10	10				■	
		10 pole	V7-CJ8-10	12.25	10				■	
		40 pole	V7-CJ8-40	42.00	5				■	
		2 pole	V7-CJS11-2	5.30	10					■
		3 pole	V7-CJS11-3	7.10	10					■
		2 pole	V7-CJ14-2	5.80	10					
		3 pole	V7-CJ14-3	8.70	10					
		2 pole	V7-CJD5-2	2.60	10					
		3 pole	V7-CJD5-3	3.80	10					
		10 pole	V7-CJD5-10	10.00	10					
		50 pole	V7-CJD5-50	42.00	5					
		2 pole	V7-CJD6-2	2.40	10					
		3 pole	V7-CJD6-3	3.50	10					
	10 pole	V7-CJD6-10	9.40	10						
	50 pole	V7-CJD6-50	37.00	5						
	10 pole	V7-CJT5-10	10.00	10						
	50 pole	V7-CJT5-50	42.00	10						
 <p>Center Jumper Links Joins two Center Jumpers</p>			V7-CJL5	1.35	10	■				
				V7-CJL6	1.35	10		■		
				V7-CJL7	1.35	10			■	
				V7-CJL8	1.35	10				■
				V7-CJDL6	1.35	10				
 <p>Center Jumper Covers</p>			V7-CJCW5	5.30	20	■				
				V7-CJCW6	5.30	20		■	■	■
				V7-CJCW14	5.30	10				
 <p>Screwdriver - Specially designed for the screws on V7-W3, W4 & W6 terminals</p>			V7-SCRDRV1	16.50	1	■	■	■		

Note: For full line of marking accessories see the Marking Section beginning on page N38.

-W35 Through	pg. N7
-W70 Through	pg. N7
-WDG4C Two Level Ground	pg. N12
-WG4 Ground	pg. N10
-WG6 Ground	pg. N10
-WG10S Ground	pg. N10
-WG16, -W35, -W70 Ground	pg. N11
-WD3 Two Level	pg. N8
-WD4 Two Level	pg. N8
-WD6 Two Level	pg. N8
-W3TW 2 in / 1 out	pg. N9
-WR3 Return	pg. N9
-WKD3 Knife Disconnect	pg. N16
-WKD3TP Knife Disconnect	pg. N16
-WKD6 Knife Disconnect	pg. N16
-W4P Pluggable	pg. N20
-W4PTP Pluggable	pg. N20
-WD4P Pluggable 2 level	pg. N21
-WDG4P Pluggable 2 Level	pg. N21
-WD4C/DF/DR 2 level	pg. N22
-WFB4/424/4250 Fuse Pluggable	pg. N13
-H4/5/6/7 Fusible	pg. N14&17
-WFB10V/VA	pg. N15
-WTC3E/J/T Thermocouple	pg. N23
-WTF3/LP/LN Sensor	pg. N18
-WTS3/LP/LN Sensor	pg. N19

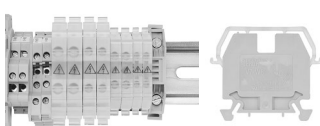
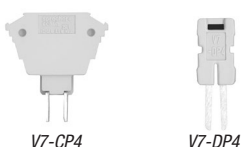
Continued on next page ➡

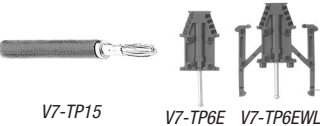
Accessories (Continued)

Component	Description	Type	Catalog Number	Price Each	Std. Pkg.	Terminal Block				
						pg. N5 -W3 Through	pg. N5 -W4 Through	pg. N5 -W6 Through	pg. N6 -W10 Through	pg. N6 -W16S Through
 <p>V7-PP35 V7-PPD3</p>	Partition Plates Provides visual and electrical spacing between adjacent jumpers		V7-PP10	1.80	50					
			V7-PP3	1.50	50	■	■			
		(shown)	V7-PP35	2.50	25					
		(shown)	V7-PPD3	2.25	50					
			V7-PPD6	2.25	50					
		Mini	V7-PPSL3	1.95	50					
		Mini	V7-PPTS3	1.25	50					
 <p>V7-SP3 V7-SPD3</p>	Separation Plate Thin, flexible plastic insulation plate provides visual and electrical isolation between adjacent center jumpers	(shown)	V7-SP3	.90	50	■	■			
		(shown)	V7-SPD3	.90	50					
	Electrical Warning Plates		V7-EWP5-4	2.25	10	■				
			V7-EWP6-4	2.25	10		■			
			V7-EWP7-4	2.25	10			■		
			V7-EWP8-4	3.00	10				■	
 <p>V7-CP4 V7-DP4</p>	Component Plugs Holds customer supplied diode or resistor Disconnect Plug No load isolator		V7-CP4	7.40	50					
			V7-DP4	2.70	50					
	Fuse Plugs Holds 5x20 fuse	W/O BFI	V7-FP4	11.00	50					
		W/ 24V BFI LED	V7-FP424	22.00	50					
		W/ 240V BFI LED	V7-FP4250	22.00	50					
 <p>V7-TP15 V7-TP6E V7-TP6EWL</p>	Test Plugs Wire is soldered directly to plug	(shown)	V7-TP15	17.75	10					
			V7-TP23	8.90	10					
			V7-TP28	8.90	10		■	■	■	
		(shown)	V7-TP6E	13.00	10		■			
		(shown)	V7-TP6EWL	13.00	10		■			
			V7-TP6E	13.00	10					
 <p>V7-TA40 V7-TA285</p>	Test Plugs Adapters Accepts Banana Plug	(shown)	V7-TA285	17.75	10	■				
			V7-TA40	17.75	10		■	■	■	
	Group Marker Carrier Used for separating and identifying groups of terminals, snap-on, markable		V7-GM35	3.60	10	■	■	■	■	■

Note: For full line of marking accessories see the Marking Section beginning on page N38.

Mounting Rails

Item	Description	Catalog Number	Price
	DIN-rail - 2 meter lengths (≈6' 6") <ul style="list-style-type: none"> • Top Hat, low profile (price per rail) • Top Hat, high profile (price per rail) 	3F 3AF	See page A54

Multiple Wire Connection Combinations - Stranded Copper Conductors of the Same Cross-section

	Wire Size AWG (mm ²)																	
	#22	#20 (0.5)	#18 (0.75)	#16 (1.5)	#14 (2.5)	#12 (4)	#10 (6)	#8 (10)	#6 (16)	#4 (25)	#2 (35)	#1 (40)	1/0 (50)	2/0 (70)	3/0 (80)	300MCM (150)	500MCM (250)	
Catalog Number	Number of same size wires per panel																	
V7-H4,-H5,-H6,-H7	4	4	3	2	2	1												
V7-W4	4	4	3	2	2	1	1											
V7-W4P	4	4	3	2	2	1 ⑤												
V7-W4PTP	4	4	3	2	2	1 ⑤												
V7-W6	4	4	3	2	2	1	1											
V7-W10	4	4	4	4	3	2	1	1										
V7-W16S					4	3	2	2	1	1								
V7-W35 ①					3	3	3	2	2	1	1	1	1					
V7-W70 ①					5	5	5	2	2	2	2	1	1	1	1			
V7-WD6 ①			3	2	2	1	1											
V7-WD4DF	4	4	3	2	2	1												
V7-WD4DR	4	4	3	2	2	1												
V7-WD4P	4	4	3	2	2	1 ⑤												
V7-WD4PTP	4	4	3	2	2	1 ⑤												
V7-WDG4C	4	4	3	2	2	1												
V7-WDG4P...	4	4	3	2	2	1 ⑤												
V7-WFB10V(A)								1										
V7-WFB4	4	4	3	2	2	1												
V7-WG4	4	4	3	2	1	1												
V7-WG6	4	4	3	2	2	1	1	1										
V7-WG10S ①	4	4	4	4	3	2	1	1										
V7-WG16 ①							2	1	1	1								
V7-WG35 ①									2	1	1	1	1					
V7-WG70										2	1	1	1	1				
V7-WKD3TP	4	4	3	2	1													
V7-WKD6 ①			3	2	2	1	1											
V7-W3TW	4	4	3	2	1													
V7-WTF3, -WTS3 ②	4	4	3	2	1													
V7-W3, -WD3, -WKD3, -WR3	4	4	3	2	1													
V7-WD4, -WD4C	4	4	3	2	2	1												

① The multiple wire combinations for these products had not been tested at time of publication. Consult factory for latest wire combination information.

② V7-WTF... & V7-WTS... blocks have been tested for 4 - #26 and #24 AWG wires.

③ These products have a maximum European wire size of 2.5 mm², yet they are UL Listed for #12 AWG wire.

Additional Technical Information for Tie Point, Diode, and Resistor Terminal Blocks



ATTENTION: The total current flow through these terminal blocks (the sum of all inputs or the sum of all outputs) must not exceed the rated current for the device.

Tie Point Terminal Blocks — Type WD4C

Description	Type	Rating
Maximum Total Current Flow Through the Terminal Block	WD4C	10 A
Maximum Working Voltage	WD4C	300 V
Operating Ambient Temperature Range	All	-4...+104°F (-20...+40°C)
Standard Resistance Range	A	-40...+167°F (-40...+75°C)

Diode Terminal Blocks — Types WD4DF and WD4DR

Description	Symbol	Type	Rating
Peak Repetitive Reverse Voltage	V (RRM)		
Working Peak Reverse Voltage	V (RWM)	WD4DF, WD4DR	300V
DC Blocking Voltage	V (R)		
Non-Repetitive Peak Reverse Voltage (Half wave, single phase, 60 Hz)	V (RSM)	WD4DF, WD4DR	300V
RMS Reverse Voltage ^①	V (Rrms)	WD4DF, WD4DR	300V
Average Rectified Forward Current Single Phase, Resistive Load, 60 Hz	I (O)	All	1.0 A
Non-Repetitive Peak Surge Current (Surge applied at rated load)	I (FSM)	All	30 A (1 cycle)
Maximum Forward Voltage Drop [I (F) = 1.0 A]	V (F)	All	1.1 V
Maximum Reverse Current	I (R)	All	10 μA
Operating Ambient Temperature Range	T (A)	All	-4...+104°F (-20...+40°C)
Storage Temperature Range	T (S)	All	-40...+167°F (-40...+75°C)

NOTE: All parameters measured at 77°F (25°C)

^① The maximum voltage rating of the diode terminal blocks listed in this table should not be exceeded even though the maximum reverse voltage rating of the diode alone is 1000V.

Fuse Plugs ①			
Characteristic	Catalog Number		
	V7-FP4	V7-FP424	V7-FP4250
Indicator Type	Non-Indicating	LED	LED
Leakage Current	~	2 mA @ 24 V	1 mA @ 264 V
Working Voltage	Per Fuse Rating	10...57V AC/DC	85...264V AC
Fuse Size (Not Supplied)	5 x 20 mm	5 x 20 mm	5 x 20 mm

Sensor Block Wiring Diagram

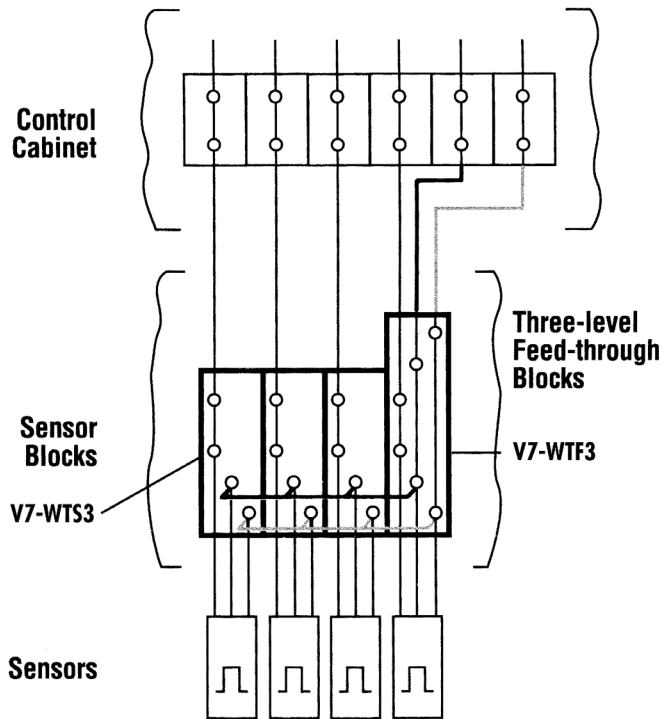

① Maximum current rating for the fuse plug is 10 A @ 250 V. IEC standards for 5 x 20 mm fuses do not include ratings above 6.3 A.

Regulatory Approvals

Terminal block products have been designed to meet the requirements of one or more regulatory bodies. Most products have also been tested per additional standards. The following is a listing of some of the regulatory bodies and standards which apply to terminal block products. See the particular product description for information on specific approvals and ratings.

UL (Underwriters Laboratories) — Devices in this catalog with one of these ratings have been tested by Underwriters Laboratories and meet the requirements of one or more of the following United States Standards:

- UL 457 — Grounding and Bonding Equipment
- UL 486E — Equipment Wiring Terminals for Use With Aluminum and/or Copper Conductors
- UL 1059 — Standard for Terminal Blocks

Reference UL file E195677

cUL (Underwriters Laboratories) — Devices in this catalog with this rating have been tested by Underwriters Laboratories and meet the requirements of the following Canadian Standard:

- CSA 22.2 No. 158 — Terminal Blocks

Reference UL file E195677

CSA (Canadian Standards Association) — Devices in this catalog with this rating have been tested by the Canadian Standards Association and meet the requirements of the following Canadian Standard:

- CSA 22.2 No. 158 — Terminal Blocks

Reference CSA files 205830 and 206918

CE Terminal blocks listed in this catalog (with the exception of the V7-WTC3E, -WTC3J, and -WTC3T) meet the requirements of the Low Voltage Directive put forth by the European Union. Devices have been tested and comply with one or more of the following European Norms:

- EN 50947-1 — Low Voltage Switchgear and Controlgear: General Rules
- EN 60947-7-1 — Low Voltage Switchgear and Controlgear: Terminal Blocks for Copper Conductors
- EN 60947-7-2 — Low Voltage Switchgear and Controlgear: Protective Conductor Terminal Blocks for Copper Conductors

IEC (International Electrotechnical Commission) — Devices listed in this catalog with “IEC” ratings meet the requirements of one or more of the following standards:

- IEC 60947-1 — Low Voltage Switchgear and Controlgear: General Rules
- IEC 60947-7-1 — Low Voltage Switchgear and Controlgear: Part 7: Ancillary Equipment, Section 1: Terminal Blocks for Copper Conductors
- IEC 60947-7-2 — Low Voltage Switchgear and Controlgear: Part 7: Ancillary Equipment, Section 2: Protective Conductor Terminal Blocks for Copper Conductors

Ex e II — Devices listed in this catalog with an “Ex e II” rating meet the following Canadian Standards per Underwriters Laboratories:

- E79-0-95 — Electrical Apparatus for Explosive Atmospheres — Part 0 — General Requirements
- E79-7-95 — Electrical Apparatus for Explosive Atmospheres — Part 7 — Increased Safety “e”

These products are suitable for Class I, Zone 1 Hazardous Locations. Reference UL file E195676

AEx e II Devices listed in this catalog with an “AEx e II” rating meet the following United States Standard per Underwriters Laboratories:

- UL 2279 — Standard for Electrical Equipment for Use in Class I, Zone 0, 1, and 2 Hazardous (Classified) Locations

These products are suitable for Class I, Zone 1 Hazardous Locations. Reference UL file E195676

V7 Terminal Approvals

Catalog Number V7-...	UL Approvals								CSA Certifications	
	Terminal Block - Component			Terminal Blocks - For Use in Hazardous Locations			Grounding and Bonding Equipment-Component		Terminal Blocks	
	UR	cUR	File No.	UR	cUR	File No.	UR	File No.	CSA	File No.
	(XCFR2)	(XCFR8)		(XCIB2)	(XCIB8)		(KDER2)		(622801)	
H4	X		E195677						X	206918
H5	X		E195677						X	206918
H6	X		E195677						X	206918
H7	X		E195677						X	206918
W10	X		E195677	X	X	E195676			X	206918
W16S	X		E195677	X	X	E195676			X	206918
W3	X		E195677	X	X	E195676			X	206918
W35	X	X	E195677	X	X	E195676			X	205830
W3TW	X		E195677	X	X	E195676			X	206918
W4	X		E195677	X	X	E195676			X	206918
W4P	X		E195677						X	206918
W4PTP	X		E195677						X	206918
W6	X		E195677	X	X	E195676			X	206918
W70	X	X	E195677	X	X	E195676			X	205830
WD3	X		E195677	X	X	E195676			X	206918
WD4	X		E195677	X	X	E195676			X	206918
WD4C	X		E195677	X	X	E195676			X	206918
WD4DF	X		E195677						X	206918
WD4DR	X		E195677						X	206918
WD4P	X		E195677						X	206918
WD6	X	X	E195677						X	205830
WDG4P	X		E195677						X	206918
WDG4C	X	X	E195677							
WFB4	X		E195677						X	206918
WFB424	X		E195677						X	206918
WFB4250	X		E195677						X	206918
WFB10V	X	X	E195677							
WFB10VA	X	X	E195677							
WG10	X	X	E195677	X	X	E195676	X	E195567		
WG16	X	X	E195677	X	X	E195676	X	E195567	X	205830
WG35	X	X	E195677	X	X	E195676	X	E195567	X	205830
WG4	X		E195677	X	X	E195676			X	206918
WG6	X		E195677	X	X	E195676			X	206918
WG70	X	X	E195677							
WKD3	X		E195677						X	206918
WKD3TP	X		E195677						X	206918
WKD6	X	X	E195677						X	205830
WR3	X		E195677						X	206918
WTF3	X		E195677						X	206918
WTF3LN	X		E195677						X	206918
WTF3LP	X		E195677						X	206918
WTS3	X		E195677						X	206918
WTS3LN	X		E195677						X	206918
WTS3LP	X		E195677						X	206918

3F Top Hat Low Profile DIN Rail

Dimensions are in millimeters (inches). Dimensions not intended for manufacturing purposes.

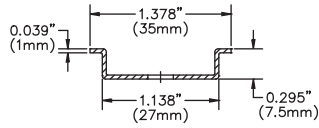

FRONT SECTION



RIGHT SIDE VIEW

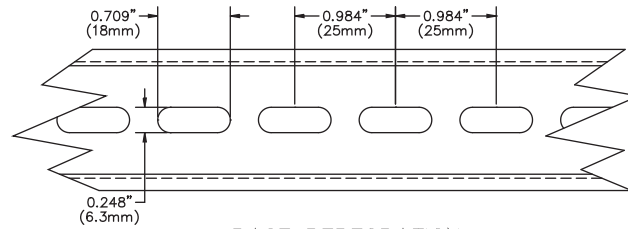

BASE PERFORATION

3AF Top Hat High Profile DIN Rail

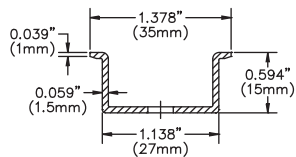

FRONT SECTION

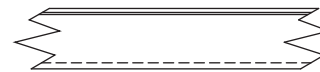

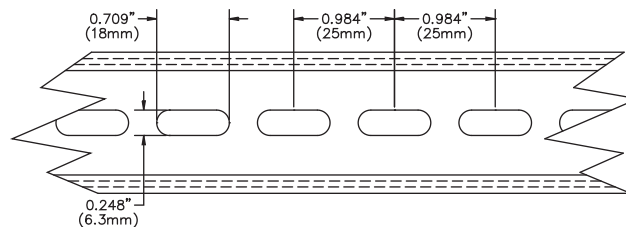

RIGHT SIDE VIEW







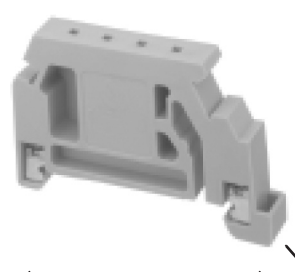

BASE PERFORATION







End Anchors

 <p>1.09" (27.6 mm) 2.04" (51.9 mm) 0.31" (8 mm) V7-EA35</p>	 <p>1.97" (50 mm) 1.97" (50 mm) 0.47" (12 mm) V7-EAH3</p>	 <p>0.93" (23.7 mm) 1.78" (45.2 mm) 0.31" (8 mm) V7-ER35</p>
-----------------------------------------------------------------------------------------------------------------------------------------------------------	--------------------------------------------------------------------------------------------------------------------------------------------------------	-------------------------------------------------------------------------------------------------------------------------------------------------------------

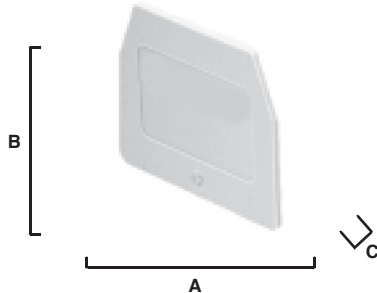
Partition Plates

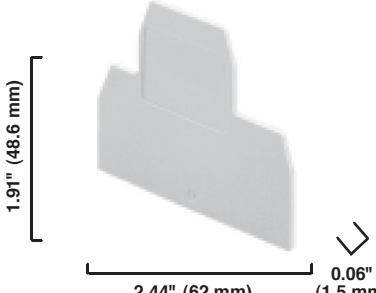
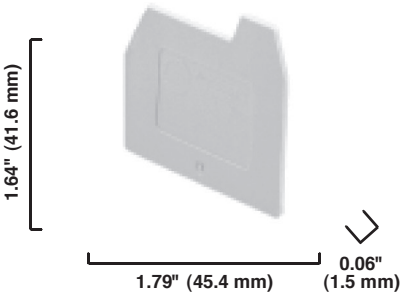
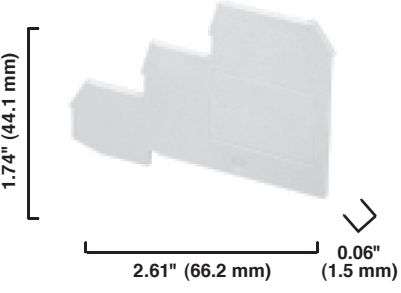
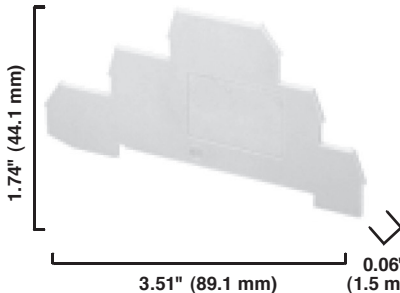
 <p>2.99" (76 mm) 2.68" (68 mm) 0.08" (2 mm) V7-PP35</p>	 <p>A, B, C Catalog # A B C V7-PP3 1.85" (47 mm) 1.57" (40 mm) 0.06" (1.5 mm) V7-PP10 2.17" (55 mm) 1.81" (46 mm) 0.06" (1.5 mm) V7-PPSL3 2.20" (56 mm) 1.54" (39 mm) 0.08" (2 mm)</p>	 <p>A, B, C Catalog # A B C V7-PPD3 2.82" (71.6 mm) 2.09" (53.2 mm) 0.08" (2 mm) V7-PPD6 3.31" (84 mm) 2.72" (69 mm) 0.08" (2 mm)</p>
 <p>1.85" (47.1 mm) 2.88" (73.2 mm) 0.014" (0.35 mm) V7-PPTS3</p>	 <p>1.57" (40.0 mm) 1.76" (44.8 mm) 0.014" (0.35 mm) V7-SP3</p>	 <p>2.19" (55.5 mm) 2.44" (62.0 mm) 0.014" (0.35 mm) V7-SPD3</p>

End Barriers

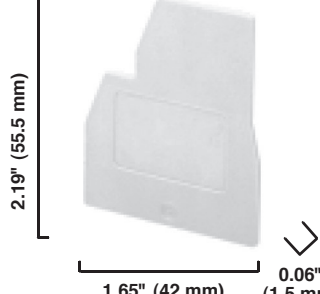
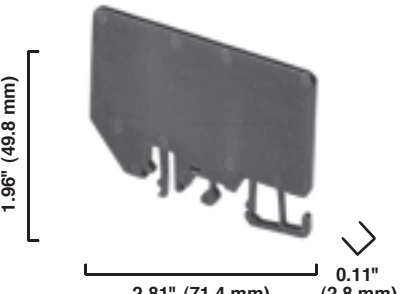
 <table border="1" data-bbox="162 630 576 766"> <thead> <tr> <th>Catalog #</th> <th>A</th> <th>B</th> <th>C</th> </tr> </thead> <tbody> <tr> <td>V7-EB3</td> <td>1.46"</td> <td>1.38"</td> <td>0.06"</td> </tr> <tr> <td>V7-EB3-Y</td> <td>(37 mm)</td> <td>(35 mm)</td> <td>(1.5 mm)</td> </tr> <tr> <td>V7-EB10</td> <td>1.77"</td> <td>1.61"</td> <td>0.06"</td> </tr> <tr> <td>V7-EB10-Y</td> <td>(45 mm)</td> <td>(41 mm)</td> <td>(1.5 mm)</td> </tr> </tbody> </table>	Catalog #	A	B	C	V7-EB3	1.46"	1.38"	0.06"	V7-EB3-Y	(37 mm)	(35 mm)	(1.5 mm)	V7-EB10	1.77"	1.61"	0.06"	V7-EB10-Y	(45 mm)	(41 mm)	(1.5 mm)	 <p data-bbox="795 651 868 682">V7-EB35</p>	 <p data-bbox="1250 651 1339 682">V7-EBD3/Y</p>
Catalog #	A	B	C																			
V7-EB3	1.46"	1.38"	0.06"																			
V7-EB3-Y	(37 mm)	(35 mm)	(1.5 mm)																			
V7-EB10	1.77"	1.61"	0.06"																			
V7-EB10-Y	(45 mm)	(41 mm)	(1.5 mm)																			
 <p data-bbox="324 1113 414 1144">V7-EB3TW</p>	 <p data-bbox="787 1113 876 1144">V7-EBTS3</p>	 <p data-bbox="1250 1113 1339 1144">V7-EBTF3</p>																				
 <p data-bbox="324 1533 414 1564">V7-EBKD3</p>	 <p data-bbox="787 1533 876 1564">V7-EBD4P</p>	 <p data-bbox="1250 1533 1339 1564">V7-EBD6</p>																				
 <p data-bbox="332 1911 406 1942">V7-EBR3</p>	 <p data-bbox="803 1911 868 1942">V7-N37</p>																					

Terminal Marking Systems

Stock and custom marking solutions to meet any requirement

Whether you're marking individual terminals or terminal groups, Sprecher + Schuh's V7-W are accompanied by a wide array of marking solutions. From standard preprinted marker cards to custom marking with our EK Vario Sign software and plotter system, Sprecher + Schuh offers a tremendous variety of options for labeling any terminal assembly.

Marking Cards for all terminal types

Blank, preprinted and custom Marking Cards are available for all sizes of V7-W terminals. Preprinted selections include ten numbers in a series printed either vertically or horizontally. Custom Marking Cards are also available.

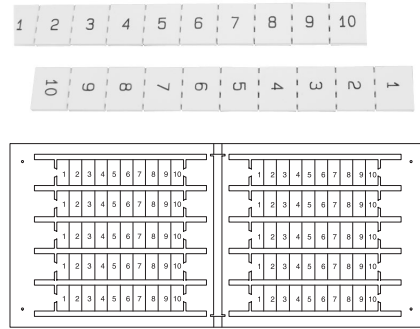

Single Digit Marking Tabs

Selected V7-W terminals can be marked with Single Digit Marking Tabs. This convenient marking system is ideal for applications where professional marking is required, but time is critical. Single digit, preprinted alphanumeric characters can be mixed and matched to provide exactly the right label for any terminal.

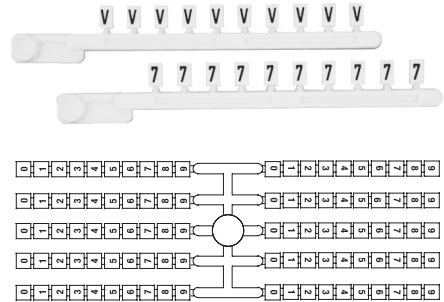

Complete Terminal Marking System

Sprecher + Schuh's Terminal Marking System is the ultimate solution for creating custom Marking Cards with total flexibility and fast turnaround. The system comes complete with everything required to plot your own marking tags (except a Windows based PC). Two Marking Cards can be plotted at a time. That's enough tags to professionally label 200 terminals in only minutes.

Unlimited jobs can be input and stored for future plotting using Sprecher + Schuh's new EK Vario Sign software, which is very intuitive and easy to learn.

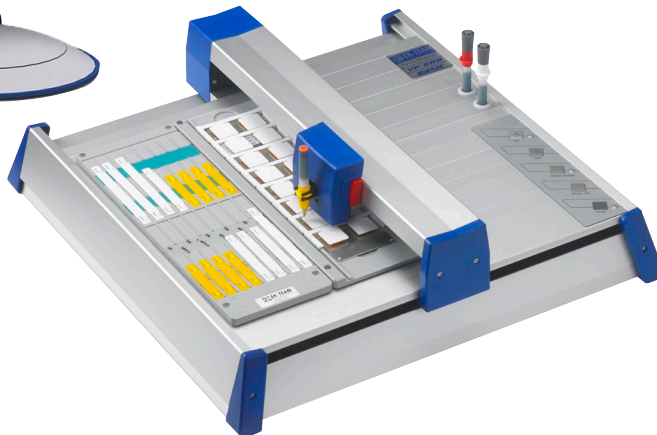

Custom Marking Cards

All sizes of Sprecher + Schuh Marking Cards can be custom printed on our terminal plotter system. In addition to alphanumeric characters, 17 electrical symbols are also available. There are three convenient methods for obtaining custom Marking Cards:

- Hand write your order on the Custom Printed Marker Cards Order Form on page N45 and fax it to us.
- Use Sprecher + Schuh's EK Vario Sign software to create your own terminal marking files and email them to us for plotting.
- Purchase our complete Terminal Marking System and plot Marking Cards any time you like!

Hand written orders

If you just have a few different cards to plot, or a lot of cards that are similar to one another, using the hand written form is very convenient. Turn to page 45 and follow the instructions for completing and sending the form to us.

EK Vario Sign software

Sprecher + Schuh's new EK Vario Sign software works in conjunction with our Terminal Marking System to professionally plot all sizes of Marking Cards.

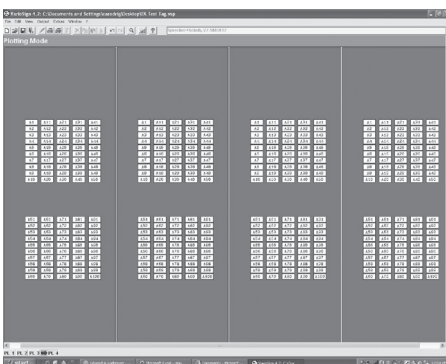
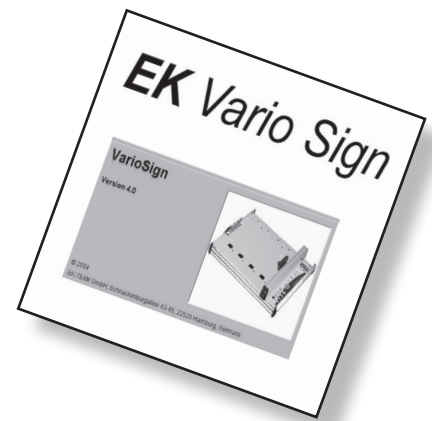

Our new EK Vario Sign software allows you to design tags for two or four Marking Cards at a time. The screen looks exactly like the plotting surface on the Terminal Marking System.

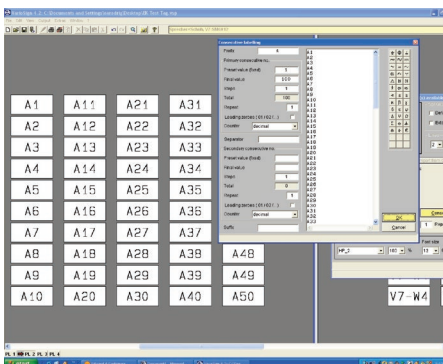

Zoom-in on one card at a time to input individual marking tags... you can also identify a starting tag and ending tag to "autofill" a range of numbers.

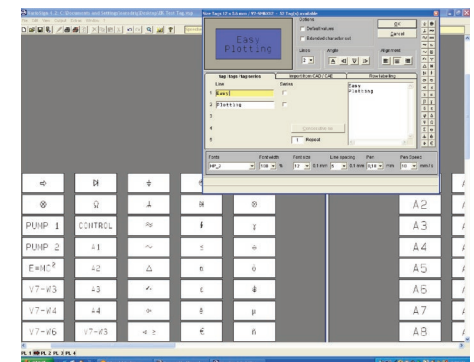

Zoom-in further for "fine tuning" of each marking tag. Adjust spacing left, right, up or down and vary type size to fill each tag with the largest possible type.

Marker Coordination Table (refer to this table to determine marker size and type)

Terminal Type	Marking Card Size and Type						Marking Tab Size and Type	
	5 X 5mm V7-SM5X5	5 X 9mm V7-SM5X9	5 X 12mm V7-SM5X12	6 X 9mm V7-SM6X9	6 X 12mm V7-SM6X12	8 X 12mm V7-SM8X12	6mm V7-MP	5mm V7-MP5
CA7-FMA2 (tag carrier)					■		■	■
V7-W3		■	■					■
V7-W4					■		■	
V7-W6					■		■	
V7-W10						■		
V7-W16S					■		■	
V7-W35					■		■	
V7-W70 / WG70					■		■	
V7-W3TW		■						■
V7-WR3		■						■
V7-WD3		■						■
V7-WD4				■			■	
V7-WD6					■		■	
V7-WFB10V / WFB10VA					■		■	
V7-WG4					■		■	
V7-WG6					■		■	
V7-WG10S						■		
V7-WG16					■		■	
V7-WG35					■		■	
V7-WKD3		■						■
V7-WKD3TP		■						■
V7-WKD6					■		■	
V7-W4P					■		■	
V7-W4PTP					■		■	
V7-CP4 (component plug)	■							
V7-WDP4				■			■	
V7-WDG4P				■			■	
V7-WFB4 / 24 / 250				■ ①		■ ②		
V7-H4 / 5 / 6 / 7						■		
V7-WTF3 / LN / LP		■						■
V7-WTS3 / LN / LP		■						■
V7-WD4C / DF / DR				■			■	
V7-WTC3 / J / K / T		■						■
V7-EA35					■			
V7-ER35						■		

① Use this size for marking fuse terminal handle.
 ② Use this size for marking fuse terminal base.

Marker Cards

10 numbers in a series (repeat sequence of 10 numbers)

(100 tags per card - 5 cards per box)
Orientation shown is horizontal (catalog code "H")

Description	Catalog Number	Price (Each)	Std. Pkg.
Marker Cards - Blank or preprinted. Refer to Marker Coordination Table (p. N40) to determine tag size required for terminal.			
Blank Cards 5 x 5mm 5 x 9mm 5 x 12mm 6 x 9mm 6 x 12mm 8 x 12mm	V7-SM5X5 V7-SM5X9 V7-SM5X12 V7-SM6X9 V7-SM6X12 V7-SM8X12	12.00 ①	5
Custom Marking Cards Charge per card for custom marking. Price includes Marking Card.	See pages N42 for information on custom marking	16.50	1

Catalog Number Codes

Tag Size Code (replace "▼")		
Code	Width (mm)	Height (mm)
5X5	5	5
5X9	5	9
5X12	5	12
6X9	6	9
6X12	6	12
8X12	8	12

Orientation (replace "*")	
Code	Direction
H	Horizontal
V	Vertical



Horizontal Marking



Vertical Marking

Ordering Instructions

- Refer to the Marker Coordination Table on page N40 to determine the tag size required for your terminal type
- Specify catalog number

- Replace (▼) With Tag Size Code
- Replace (*) With Orientation Code

See code tables on this page for codes

Description	Catalog Number	Price (Each)	Std. Pkg.
Preprinted, 10 numbers in a series (see pages N42 for information on custom marking)			
"1 - 10"	V7-SM▼*01	12.00	1
"11 - 20"	V7-SM▼*02		
"21 - 30"	V7-SM▼*03		
"31 - 40"	V7-SM▼*04		
"41 - 50"	V7-SM▼*05		
"51 - 60"	V7-SM▼*06		
"61 - 70"	V7-SM▼*07		
"71 - 80"	V7-SM▼*08		
"81 - 90"	V7-SM▼*09		
"91 - 100"	V7-SM▼*10		
"101 - 110"	V7-SM▼*11	12.00	1
"111 - 120"	V7-SM▼*12		
"121 - 130"	V7-SM▼*13		
"131 - 140"	V7-SM▼*14		
"141 - 150"	V7-SM▼*15		
"151 - 160"	V7-SM▼*16		
"161 - 170"	V7-SM▼*17		
"171 - 180"	V7-SM▼*18		
"181 - 190"	V7-SM▼*19		
"191 - 200"	V7-SM▼*20		
"201 - 210"	V7-SM▼*21	12.00	1
"211 - 220"	V7-SM▼*22		
"221 - 230"	V7-SM▼*23		
"231 - 240"	V7-SM▼*24		
"241 - 250"	V7-SM▼*25		
"251 - 260"	V7-SM▼*26		
"261 - 270"	V7-SM▼*27		
"271 - 280"	V7-SM▼*28		
"281 - 290"	V7-SM▼*29		
"291 - 300"	V7-SM▼*30		
"301 - 310"	V7-SM▼*31	12.00	1
"311 - 320"	V7-SM▼*32		
"321 - 330"	V7-SM▼*33		
"331 - 340"	V7-SM▼*34		
"341 - 350"	V7-SM▼*35		
"351 - 360"	V7-SM▼*36		
"361 - 370"	V7-SM▼*37		
"371 - 380"	V7-SM▼*38		
"381 - 390"	V7-SM▼*39		
"391 - 400"	V7-SM▼*40		
"401 - 410"	V7-SM▼*41	12.00	1
"411 - 420"	V7-SM▼*42		
"421 - 430"	V7-SM▼*43		
"431 - 440"	V7-SM▼*44		
"441 - 450"	V7-SM▼*45		
"451 - 460"	V7-SM▼*46		
"461 - 470"	V7-SM▼*47		
"471 - 480"	V7-SM▼*48		
"481 - 490"	V7-SM▼*49		
"491 - 500"	V7-SM▼*50		

① Price each. Sold only in unbroken packages of 5.
For example V7-SM6X12 @ \$12 ea. = one box of 5 cards for \$60

Single Digit Marker Tabs, 6mm

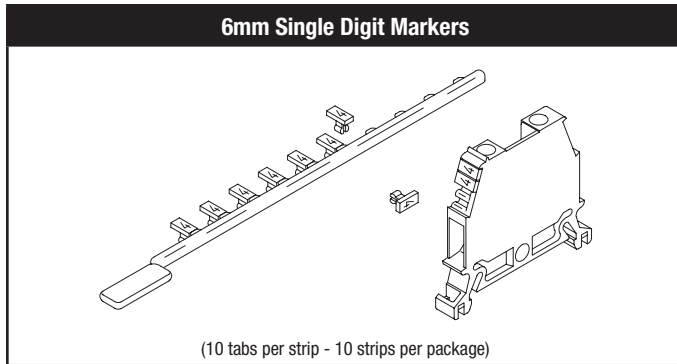

Description	Catalog Number	Price (Each)	Std. Pkg.
Single Digit Marker Tabs - For selected Series V7-W terminals only. Refer to Marker Coordination Table on page N40 to determine the tag size for your terminal type.			
Blank tabs	V7-MP-BLANK	2.70 ①	10
Preprinted, single digit (custom marking not available)			
"0"	V7-MP-0 ②		
"1"	V7-MP-1		
"2"	V7-MP-2		
"3"	V7-MP-3		
"4"	V7-MP-4		
"5"	V7-MP-5	2.70 ①	10
"6"	V7-MP-6		
"7"	V7-MP-7		
"8"	V7-MP-8		
"9"	V7-MP-9		
"0...9"	V7-MP		

Description	Catalog Number	Price (Each)	Std. Pkg.
Preprinted, single letter (custom marking not available)			
"A"	V7-MP-A		
"B"	V7-MP-B		
"C"	V7-MP-C		
"D"	V7-MP-D		
"E"	V7-MP-E		
"F"	V7-MP-F		
"G"	V7-MP-G		
"H"	V7-MP-H		
"I"	V7-MP-I		
"J"	V7-MP-J		
"K"	V7-MP-K		
"L"	V7-MP-L		
"M"	V7-MP-M	2.70 ①	10
"N"	V7-MP-N		
"P"	V7-MP-P		
"Q"	V7-MP-Q		
"R"	V7-MP-R		
"S"	V7-MP-S		
"T"	V7-MP-T		
"U"	V7-MP-U		
"V"	V7-MP-V		
"W"	V7-MP-W		
"X"	V7-MP-X		
"Y"	V7-MP-Y		
"Z"	V7-MP-Z		
Preprinted, symbols			
"+"	V7-MP-POS		
"⊥"	V7-MP-GND		
"_"	V7-MP-NEG	2.70 ①	10
"~"	V7-MP-AC		
"="	V7-MP-DC		

N

V7 Marking & Plotter

Ordering Instructions

- Refer to the Marker Coordination Table on page N40 to determine the tag size required for your terminal type
- Specify catalog number

- ① Price each. Sold only in unbroken packages .
For example **V7-MP-0** @ \$2.70 ea. = one box of 10 cards for \$27
- ② Use this tag for letter "0".

Single Digit Marker Tabs, 5mm

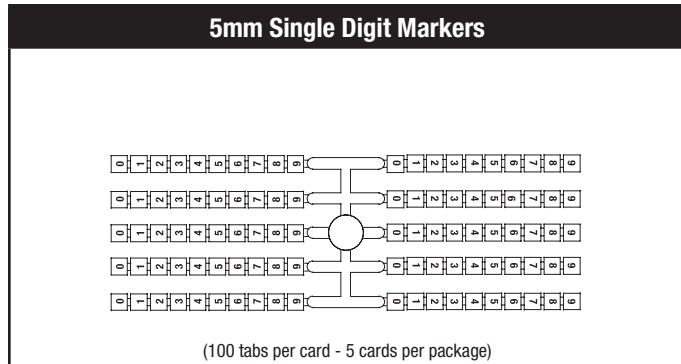

Description	Catalog Number	Price (Each)	Std. Pkg.
Single Digit Marker Tabs - For selected Series V7-W terminals only. Refer to Marker Coordination Table on page N40 to determine the tag size for your terminal type.			
Blank tabs	V7-MP5-BLANK	10.50 ①	5
Preprinted, single digit (custom marking not available)			
"0"	V7-MP5-0 ②	10.50 ①	5
"1"	V7-MP5-1		
"2"	V7-MP5-2		
"3"	V7-MP5-3		
"4"	V7-MP5-4		
"5"	V7-MP5-5		
"6"	V7-MP5-6		
"7"	V7-MP5-7		
"8"	V7-MP5-8		
"9"	V7-MP5-9		
"0...9"	V7-MP5-10	5	
"A"	V7-MP5-A		
"B"	V7-MP5-B		
"C"	V7-MP5-C		
"D"	V7-MP5-D		
"E"	V7-MP5-E		
"F"	V7-MP5-F		
"G"	V7-MP5-G		

Description	Catalog Number	Price (Each)	Std. Pkg.
"H"	V7-MP5-H	10.50 ①	5
"I"	V7-MP5-I		
"J"	V7-MP5-J		
"K"	V7-MP5-K		
"L"	V7-MP5-L		
"M"	V7-MP5-M		
"N"	V7-MP5-N		
"P"	V7-MP5-P		
"Q"	V7-MP5-Q		
"R"	V7-MP5-R		
"S"	V7-MP5-S		
"T"	V7-MP5-T		
"U"	V7-MP5-U		
"V"	V7-MP5-V		
"W"	V7-MP5-W		
"X"	V7-MP5-X		
"Y"	V7-MP5-Y		
"Z"	V7-MP5-Z		
Preprinted, symbols		10.50 ①	5
"+"	V7-MP5-POS		
"⊥"	V7-MP5-GND		
"_"	V7-MP5-NEG		
"~"	V7-MP5-AC		
"="	V7-MP5-DC		

Ordering Instructions

- Refer to the Marker Coordination Table on page N40 to determine the tag size required for your terminal type
- Specify catalog number

① Price each. Sold only in unbroken packages.
For example V7-MP5-0 @ \$10.50 ea. = one box of 5 cards for \$52.50.
② Use this tag for letter "0".

Marking Card Examples

These illustrations show the approximate actual size of all terminal markers in both vertical and horizontal orientations. The maximum number of rows and characters is also shown for each marker size.

Vertically Oriented Markers

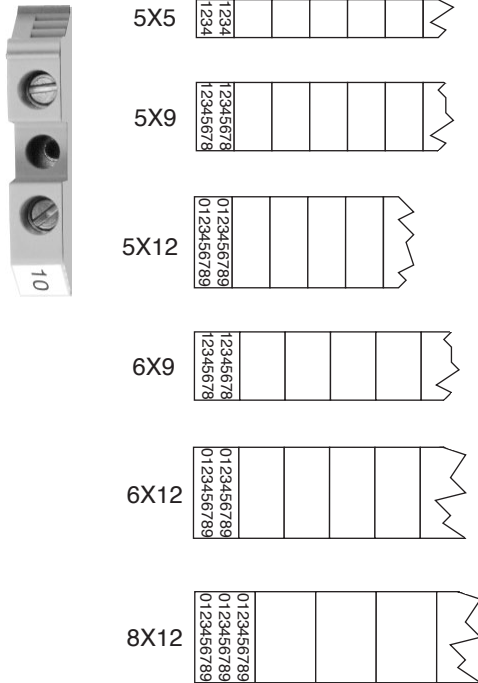

Horizontally Oriented Markers

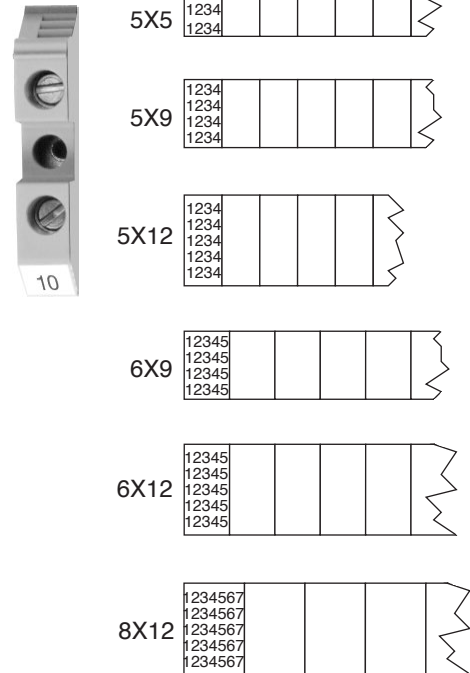

Available Marking Symbols

The following symbols can be marked on an individual tag by Sprecher + Schuh's EK Vario Sign system. Draw the symbol desired (in the correct orientation) on the marker card order form.

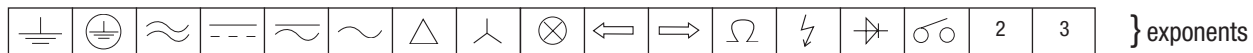

Customer Information:

Today's Date: _____ Order Form _____ of _____

Name: _____

Company: _____

Address: _____

City: _____ State: _____ Zip: _____

Telephone: _____

Job Reference: _____

Marker Card: (check size required)

- V7-SM5X5 V7-SM5X9 V7-SM5X12
 V7-SM6X9 V7-SM6X12 V7-SM8X12

Quantity of cards required exactly like this one: _____

Ordering Instructions:

- 1) Determine Marking Card size required from the Marker Coordination table. See Custom Marking Cards for pricing.
- 2) From the E-Catalog, note the maximum number of rows and characters for the tags you selected. Also note available marking symbols.
- 3) On the template below, print characters *very* clearly in the same orientation you would like them plotted.
- 4) Use a new order form for each *different* card you require.

Formatting Instructions:

- 1) Sequential numbering is acceptable using an arrow between the first and last label of the sequence.
- 2) Distinguish the lower case letter "l" from the capital letter "I" by scripting the letter "^" and including both the top and bottom lines on the letter "I".
- 3) Blank spaces should be shown with a carat (^). Example: PLC^DER
- 4) Place a "dot" in the middle of all zeros (0). Example: 0

Vertical Example

A	B	C	SECURE CLAMP	I 45	I^ 45	GND	VZ4+	l 346	I 027
---	---	---	-----------------	------	-------	-----	------	-------	-------

Horizontal Example



1	→						7	H	24 GO	I
---	---	--	--	--	--	--	---	---	----------	---

Please orient text as desired on card.

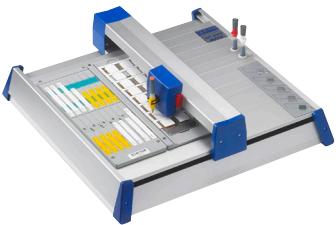



V7 Plotter System

Marking System	Description	Catalog Number	Price	Std. Pkg.	Weight
	<p>Complete Half Size Terminal Marking System: Includes:</p> <ul style="list-style-type: none"> • Plotter and USB Cable • EK Vario Sign Software CD-ROM • (1) V7-DISPEN25 Disposable Pen size .25 mm and (1) V7-DISPEN35 Disposable Pen size .35 mm • (2) Base Plates (holds up to two V7-SM... cards, purchase Marking Cards separately) • User Manual <p>Minimum computer system requirements:</p> <ul style="list-style-type: none"> • PC (1.8 GHz min.) • 64 MB RAM, CD-ROM drive • VGA graphics adapter and monitor (256 colors, resolution 1024 x 768) • Operating system: Windows 2000, XP, 7, 8, 10, and Vista 	V7-PLTKIT2-VP6H	7500	1	6 kg 13.23 lbs

V7 Plotter Accessories

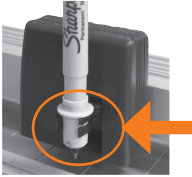
Accessory	Description	Catalog Number	Price Each	Std. Pkg.
	<p>Plotter Pen-R and Adaptor - Includes plotter pen and unfilled ink cartridge. Plotter pen accepts ink cartridges V7-PLINKCART.</p> <p>Pen Width 0.25 mm</p> <p>Pen Width 0.35 mm</p>	<p>V7-PLPEN25</p> <p>V7-PLPEN35</p>	195	1
	<p>Disposable P2.0 Ink Cartridges - Attaches to V7-PLPEN for convenient refill of Plotter Pen. (List Price includes 5 ink cartridges per package)</p>	V7-PLINKCART	71	5
	<p>Disposable Ink Pen ED-R - Plotter pen tip, black ink.</p> <p>Pen Width 0.25 mm</p> <p>Pen Width 0.35 mm</p>	<p>V7-DISPEN25</p> <p>V7-DISPEN35</p>	102	1

V7 Plotter Accessories

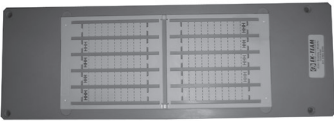
Accessory	Description	Catalog Number	Price Each	Std. Pkg.
 <p>V7-ADP</p>	<p>Adapter for Sharpie® Marker - Adapter for use with Sharpie brand Ultra-fine permanent markers (marker not sold by Sprecher+Schuh).</p>	V7-ADP	27	1
	<p>Plotter Pen Cleaning Set - The set consists of a cleaning unit and the pen cleaner, which enables two V7-PLPEN plotter pens to be cleaned. The cleaning unit can be used for up to ten cleaning cycles. ❶</p>	V7-PLCLEAN	53	1
	<p>Cleaning Solution- Plotter Pen cleaning solution for V7-PLPEN. ❶</p>	V7-PLSOLN	27	1
	<p>Plotter Service Kit for V7-PLTKIT-04 & -02</p>	V7-PLTSERV	89	1
	<p>Sprecher + Schuh universal support plate.</p>	V7-SSPLATE	1043	1

❶ Recommended for maintaining refillable pen life (V7-PLPEN_).