

LOW DROPOUT CMOS VOLTAGE REGULATOR

www.sii-ic.com

© SII Semiconductor Corporation, 2000-2015

Rev.3.1_01

The S-818 Series is a positive voltage regulator developed by CMOS technology and featured by low dropout voltage, high output voltage accuracy and low current consumption.

Built-in low on-resistance transistor provides low dropout voltage and large output current. A ceramic capacitor of 2 μF or more can be used as an output capacitor. An ON/OFF circuit ensures long battery life. The SOT-23-5 miniaturized package and the SOT-89-5 package are recommended for configuring portable devices and large output current applications, respectively.

■ Features

- Output voltage: 2.0 V to 6.0 V, selectable in 0.1 V step
- Output voltage accuracy: $\pm 2.0\%$
- Dropout voltage: 170 mV typ. (5.0 V output product, $I_{\text{OUT}} = 60 \text{ mA}$)
- Current consumption:
 - During operation: 30 μA typ., 40 μA max.
 - During power-off: 100 nA typ., 500 nA max.
- Output current:
 - Possible to output 200 mA (3.0 V output product, $V_{\text{IN}} = 4 \text{ V}$)*¹
 - Possible to output 300 mA (5.0 V output product, $V_{\text{IN}} = 6 \text{ V}$)*¹
- Output capacitor: A ceramic capacitor of 2 μF or more can be used.
- Built-in ON/OFF circuit: Ensures long battery life.
- Operation temperature range: $T_a = -40^\circ\text{C}$ to $+85^\circ\text{C}$
- Lead-free, Sn 100%, halogen-free*²

*1. Attention should be paid to the power dissipation of the package when the output current is large.

*2. Refer to "■ Product Name Structure" for details.

■ Applications

- Constant-voltage power supply for battery-powered device, personal communication device and home electric/electronic appliance

■ Packages

- SOT-23-5
- SOT-89-5

■ Block Diagram

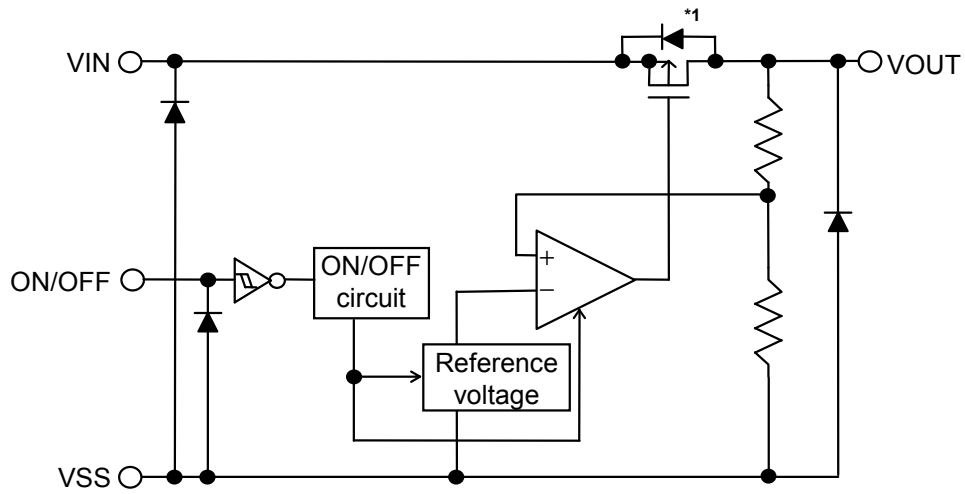

*1. Parasitic diode

Figure 1

■ Product Name Structure

1. Product name



*1. Refer to the tape drawing.

*2. Refer to the "Table 1" under the "3. Product name list".

*3. Refer to "3. ON/OFF pin" in the "■ Operation".

2. Package

Package Name	Drawing Code		
	Package	Tape	Reel
SOT-23-5	MP005-A-P-SD	MP005-A-C-SD	MP005-A-R-SD
SOT-89-5	UP005-A-P-SD	UP005-A-C-SD	UP005-A-R-SD

3. Product name list

Table 1

Output Voltage	SOT-23-5	SOT-89-5
2.0 V±2.0%	S-818A20AMC-BGAT2x	S-818A20AUC-BGAT2x
2.1 V±2.0%	S-818A21AMC-BGBT2x	S-818A21AUC-BGBT2x
2.2 V±2.0%	S-818A22AMC-BGCT2x	S-818A22AUC-BGCT2x
2.3 V±2.0%	S-818A23AMC-BGDT2x	S-818A23AUC-BGDT2x
2.4 V±2.0%	S-818A24AMC-BGET2x	S-818A24AUC-BGET2x
2.5 V±2.0%	S-818A25AMC-BGFT2x	S-818A25AUC-BGFT2x
2.6 V±2.0%	S-818A26AMC-BGGT2x	S-818A26AUC-BGGT2x
2.7 V±2.0%	S-818A27AMC-BGHT2x	S-818A27AUC-BGHT2x
2.8 V±2.0%	S-818A28AMC-BGIT2x	S-818A28AUC-BGIT2x
2.9 V±2.0%	S-818A29AMC-BGJT2x	S-818A29AUC-BGJT2x
3.0 V±2.0%	S-818A30AMC-BGKT2x	S-818A30AUC-BGKT2x
3.1 V±2.0%	S-818A31AMC-BGLT2x	S-818A31AUC-BGLT2x
3.2 V±2.0%	S-818A32AMC-BGMT2x	S-818A32AUC-BGMT2x
3.3 V±2.0%	S-818A33AMC-BGNT2x	S-818A33AUC-BGNT2x
3.4 V±2.0%	S-818A34AMC-BGOT2x	S-818A34AUC-BGOT2x
3.5 V±2.0%	S-818A35AMC-BGPT2x	S-818A35AUC-BGPT2x
3.6 V±2.0%	S-818A36AMC-BGQT2x	S-818A36AUC-BGQT2x
3.7 V±2.0%	S-818A37AMC-BGRT2x	S-818A37AUC-BGRT2x
3.8 V±2.0%	S-818A38AMC-BGST2x	S-818A38AUC-BGST2x
3.9 V±2.0%	S-818A39AMC-BGTT2x	S-818A39AUC-BGTT2x
4.0 V±2.0%	S-818A40AMC-BGUT2x	S-818A40AUC-BGUT2x
4.1 V±2.0%	S-818A41AMC-BGVT2x	S-818A41AUC-BGVT2x
4.2 V±2.0%	S-818A42AMC-BGWT2x	S-818A42AUC-BGWT2x
4.3 V±2.0%	S-818A43AMC-BGXT2x	S-818A43AUC-BGXT2x
4.4 V±2.0%	S-818A44AMC-BGYT2x	S-818A44AUC-BGYT2x
4.5 V±2.0%	S-818A45AMC-BGZT2x	S-818A45AUC-BGZT2x
4.6 V±2.0%	S-818A46AMC-BHAT2x	S-818A46AUC-BHAT2x
4.7 V±2.0%	S-818A47AMC-BHBT2x	S-818A47AUC-BHBT2x
4.8 V±2.0%	S-818A48AMC-BHCT2x	S-818A48AUC-BHCT2x
4.9 V±2.0%	S-818A49AMC-BHDT2x	S-818A49AUC-BHDT2x
5.0 V±2.0%	S-818A50AMC-BHET2x	S-818A50AUC-BHET2x
5.1 V±2.0%	S-818A51AMC-BHFT2x	S-818A51AUC-BHFT2x
5.2 V±2.0%	S-818A52AMC-BHGT2x	S-818A52AUC-BHGT2x
5.3 V±2.0%	S-818A53AMC-BHHT2x	S-818A53AUC-BHHT2x
5.4 V±2.0%	S-818A54AMC-BHIT2x	S-818A54AUC-BHIT2x
5.5 V±2.0%	S-818A55AMC-BHJT2x	S-818A55AUC-BHJT2x
5.6 V±2.0%	S-818A56AMC-BHKT2x	S-818A56AUC-BHKT2x
5.7 V±2.0%	S-818A57AMC-BHLT2x	S-818A57AUC-BHLT2x
5.8 V±2.0%	S-818A58AMC-BHMT2x	S-818A58AUC-BHMT2x
5.9 V±2.0%	S-818A59AMC-BHNT2x	S-818A59AUC-BHNT2x
6.0 V±2.0%	S-818A60AMC-BHOT2x	S-818A60AUC-BHOT2x

- Remark 1.** Please contact our sales office for type B products.
2. x: G or U
3. Please select products of environmental code = U for Sn 100%, halogen-free products.

■ **Pin Configurations**



Figure 2

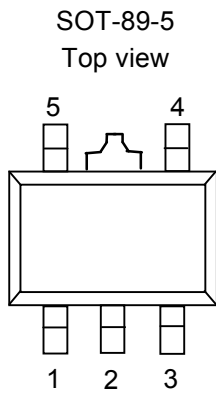

Figure 3

Table 2

Pin No.	Symbol	Pin description
1	VIN	Input voltage pin
2	VSS	GND pin
3	ON/OFF	ON/OFF pin
4	NC*1	No connection
5	VOUT	Output voltage pin

*1. The NC pin is electrically open.
The NC pin can be connected to VIN pin or VSS pin.

Table 3

Pin No.	Symbol	Pin description
1	VOUT	Output voltage pin
2	VSS	GND pin
3	NC*1	No connection
4	ON/OFF	ON/OFF pin
5	VIN	Input voltage pin

*1. The NC pin is electrically open.
The NC pin can be connected to VIN pin or VSS pin.

■ **Absolute Maximum Ratings**

Table 4

(Ta=25°C unless otherwise specified)

Item	Symbol	Absolute Maximum Rating	Unit
Input voltage	V _{IN}	V _{SS} -0.3 to V _{SS} +12	V
	V _{ON/OFF}	V _{SS} -0.3 to V _{SS} +12	V
Output voltage	V _{OUT}	V _{SS} -0.3 to V _{IN} +0.3	V
Power dissipation	P _D	250 (When not mounted on board)	mW
		600*1	mW
		500 (When not mounted on board)	mW
		1000*1	mW
Operation ambient temperature	T _{opr}	-40 to +85	°C
Storage temperature	T _{stg}	-40 to +125	°C

*1. When mounted on board
 [Mounted on board]

- (1) Board size : 114.3 mm × 76.2 mm × t1.6 mm
- (2) Board name : JEDEC STANDARD51-7

Caution The absolute maximum ratings are rated values exceeding which the product could suffer physical damage. These values must therefore not be exceeded under any conditions.

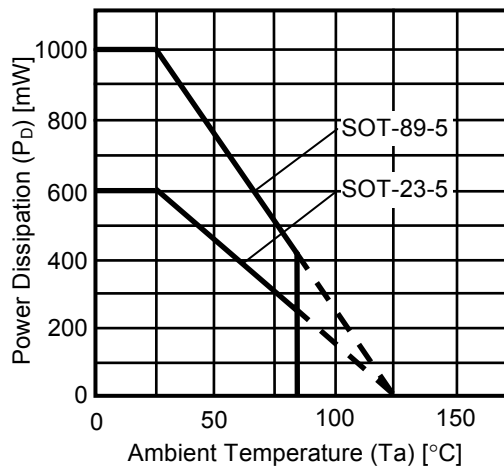

Figure 4 Power dissipation of package (When mounted on board)

■ Electrical Characteristics

Table 5

(Ta=25°C unless otherwise specified)

Item	Symbol	Condition	Min.	Typ.	Max.	Unit	Test circuit	
Output voltage*1	$V_{OUT(E)}$	$V_{IN}=V_{OUT(S)}+1\text{ V}$, $I_{OUT}=30\text{ mA}$	$V_{OUT(S)} \times 0.98$	$V_{OUT(S)}$	$V_{OUT(S)} \times 1.02$	V	1	
Output current*2	I_{OUT}	$V_{OUT(S)}+1\text{ V} \leq V_{IN} \leq 10\text{ V}$	$2.0\text{ V} \leq V_{OUT(S)} \leq 2.4\text{ V}$	100*5	—	—	mA	3
			$2.5\text{ V} \leq V_{OUT(S)} \leq 2.9\text{ V}$	150*5	—	—	mA	3
			$3.0\text{ V} \leq V_{OUT(S)} \leq 3.9\text{ V}$	200*5	—	—	mA	3
			$4.0\text{ V} \leq V_{OUT(S)} \leq 4.9\text{ V}$	250*5	—	—	mA	3
			$5.0\text{ V} \leq V_{OUT(S)} \leq 6.0\text{ V}$	300*5	—	—	mA	3
Dropout voltage*3	V_{drop}	$I_{OUT}=60\text{ mA}$	$2.0\text{ V} \leq V_{OUT(S)} \leq 2.4\text{ V}$	—	0.51	0.87	V	1
			$2.5\text{ V} \leq V_{OUT(S)} \leq 2.9\text{ V}$	—	0.38	0.61	V	1
			$3.0\text{ V} \leq V_{OUT(S)} \leq 3.4\text{ V}$	—	0.30	0.44	V	1
			$3.5\text{ V} \leq V_{OUT(S)} \leq 3.9\text{ V}$	—	0.24	0.33	V	1
			$4.0\text{ V} \leq V_{OUT(S)} \leq 4.4\text{ V}$	—	0.20	0.26	V	1
			$4.5\text{ V} \leq V_{OUT(S)} \leq 4.9\text{ V}$	—	0.18	0.22	V	1
			$5.0\text{ V} \leq V_{OUT(S)} \leq 5.4\text{ V}$	—	0.17	0.21	V	1
		$5.5\text{ V} \leq V_{OUT(S)} \leq 6.0\text{ V}$	—	0.17	0.20	V	1	
Line regulation 1	$\frac{\Delta V_{OUT1}}{\Delta V_{IN} \cdot V_{OUT}}$	$V_{OUT(S)}+0.5\text{ V} \leq V_{IN} \leq 10\text{ V}$, $I_{OUT}=30\text{ mA}$	—	0.05	0.2	%/V	1	
Line regulation 2	$\frac{\Delta V_{OUT2}}{\Delta V_{IN} \cdot V_{OUT}}$	$V_{OUT(S)}+0.5\text{ V} \leq V_{IN} \leq 10\text{ V}$, $I_{OUT}=10\text{ }\mu\text{A}$	—	0.05	0.2	%/V	1	
Load regulation	ΔV_{OUT3}	$V_{IN}=V_{OUT(S)}+1\text{ V}$, $10\text{ }\mu\text{A} \leq I_{OUT} \leq 80\text{ mA}$	—	30	50	mV	1	
Output voltage temperature coefficient*4	$\frac{\Delta V_{OUT}}{\Delta T_a \cdot V_{OUT}}$	$V_{IN}=V_{OUT(S)}+1\text{ V}$, $I_{OUT}=30\text{ mA}$, $-40^\circ\text{C} \leq T_a \leq 85^\circ\text{C}$	—	± 100	—	ppm/ °C	1	
Current consumption during operation	I_{SS1}	$V_{IN}=V_{OUT(S)}+1\text{ V}$, ON/OFF pin=ON, no load	—	30	40	μA	2	
Current consumption during power-off	I_{SS2}	$V_{IN}=V_{OUT(S)}+1\text{ V}$, ON/OFF pin=OFF, no load	—	0.1	0.5	μA	2	
Input voltage	V_{IN}	—	—	—	10	V	1	
ON/OFF pin input voltage "H"	V_{SH}	$V_{IN}=V_{OUT(S)}+1\text{ V}$, $R_L=1\text{ k}\Omega$, determined by V_{OUT} output level.	1.5	—	—	V	4	
ON/OFF pin input voltage "L"	V_{SL}	$V_{IN}=V_{OUT(S)}+1\text{ V}$, $R_L=1\text{ k}\Omega$, determined by V_{OUT} output level.	—	—	0.3	V	4	
ON/OFF pin input current "H"	I_{SH}	$V_{IN}=V_{OUT(S)}+1\text{ V}$, $V_{ON/OFF}=7\text{ V}$	-0.1	—	0.1	μA	4	
ON/OFF pin input current "L"	I_{SL}	$V_{IN}=V_{OUT(S)}+1\text{ V}$, $V_{ON/OFF}=0\text{ V}$	-0.1	—	0.1	μA	4	
Ripple rejection	$ RR $	$V_{IN}=V_{OUT(S)}+1\text{ V}$, $f=100\text{ Hz}$, $\Delta V_{rip}=0.5\text{ V p-p}$, $I_{OUT}=30\text{ mA}$	—	45	—	dB	5	

- *1. $V_{OUT(S)}$: Set output voltage
 $V_{OUT(E)}$: Actual output voltage
Output voltage when fixing I_{OUT} (=30 mA) and inputting $V_{OUT(S)}+1.0$ V
- *2. The output current at which output voltage becomes 95 % of $V_{OUT(E)}$ after gradually increasing output current.
- *3. $V_{drop}=V_{IN1} - (V_{OUT(E)} \times 0.98)$
 - *1. The Input voltage at which output voltage becomes 98 % of $V_{OUT(E)}$ after gradually decreasing input voltage.
- *4. A change in the temperature of the output voltage [mV/°C] is calculated using the following equation.
$$\frac{\Delta V_{OUT}}{\Delta T_a} [\text{mV}/^\circ\text{C}]^*1 = V_{OUT(S)} [\text{V}]^*2 \times \frac{\Delta V_{OUT}}{\Delta T_a \bullet V_{OUT}} [\text{ppm}/^\circ\text{C}]^*3 \div 1000$$
 - *1. Change in temperature of output voltage
 - *2. Set output voltage
 - *3. Output voltage temperature coefficient
- *5. The output current can be at least this value.

■ **Test Circuits**

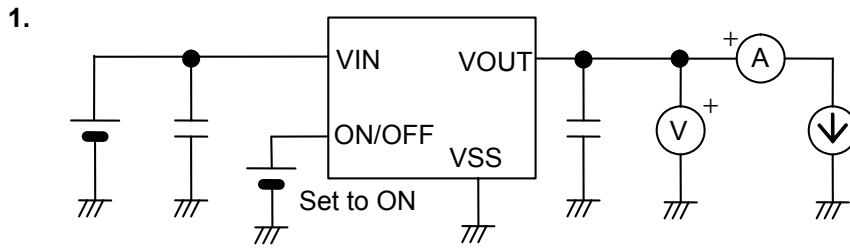

Figure 5

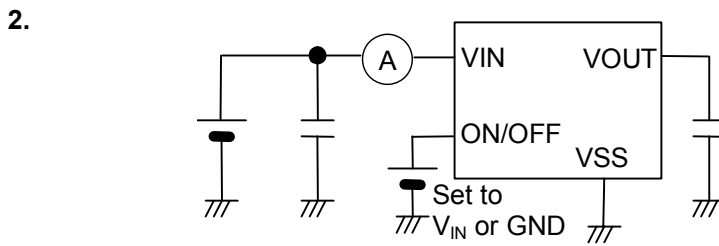

Figure 6

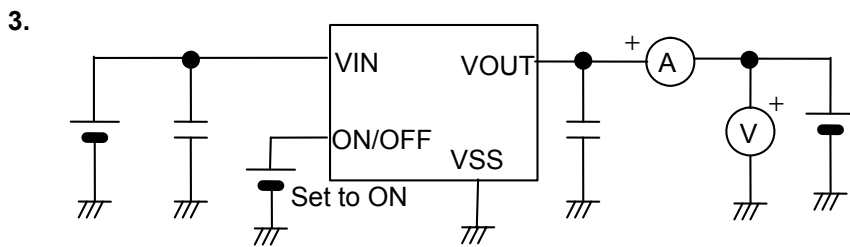

Figure 7

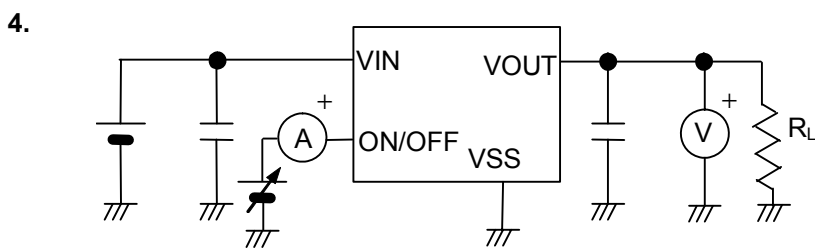

Figure 8

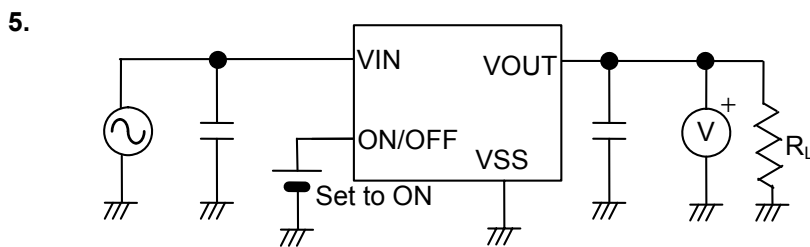

Figure 9

■ Condition of Application

Input capacitor (C_{IN}):	0.47 μ F or more
Output capacitor (C_L):	2 μ F or more
Equivalent series resistor (ESR):	10 Ω or less
Input series resistor (R_{IN}):	10 Ω or less

Caution Generally a series regulator may cause oscillation, depending on the selection of external parts. Check that no oscillation occurs with the application using the above capacitor.

■ Standard Circuit

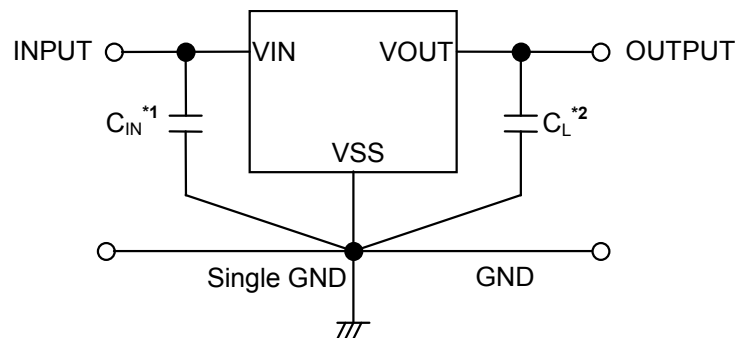

*1. C_{IN} is a capacitor for stabilizing the input. Use a capacitor of 0.47 μ F or more.

*2. In addition to a tantalum capacitor, a ceramic capacitor of 2.0 μ F or more can be used for C_L .

Figure 10

Caution The above connection diagram and constant will not guarantee successful operation. Perform through evaluation using the actual application to set the constant.

■ Explanation of Terms

1. Low dropout voltage regulator

This voltage regulator has the low dropout voltage due to its built-in low on-resistance transistor.

2. Output voltage (V_{OUT})

The accuracy of the output voltage is ensured at $\pm 2.0\%$ under the specified conditions of input voltage, output current, and temperature, which differ product by product.

Caution When the above conditions are changed, the output voltage may vary and go out of the accuracy range of the output voltage. Refer to the “■ Electrical Characteristics” and “■ Characteristics (Typical Data)” for details.

3. Line regulation 1 (ΔV_{OUT1}) and Line regulation 2 (ΔV_{OUT2})

Line regulation indicates the input voltage dependence of the output voltage. The value shows how much the output voltage changes due to the change of the input voltage when the output current is kept constant.

4. Load regulation (ΔV_{OUT3})

Load regulation indicates the output current dependence of output voltage. The value shows how much the output voltage changes due to the change of the output current when the input voltage is kept constant.

5. Dropout voltage (V_{drop})

Indicates the difference between input voltage (V_{IN1}) and the output voltage when; decreasing input voltage (V_{IN}) gradually until the output voltage has dropped out to the value of 98% of the actual output voltage $V_{OUT(E)}$.

$$V_{drop} = V_{IN1} - (V_{OUT(E)} \times 0.98)$$

6. Output voltage temperature coefficient $\left(\frac{\Delta V_{OUT}}{\Delta T_a \bullet V_{OUT}}\right)$

The shaded area in **Figure 11** is the range where V_{OUT} varies in the operation temperature range when the output voltage temperature coefficient is ± 100 ppm/ $^{\circ}C$.

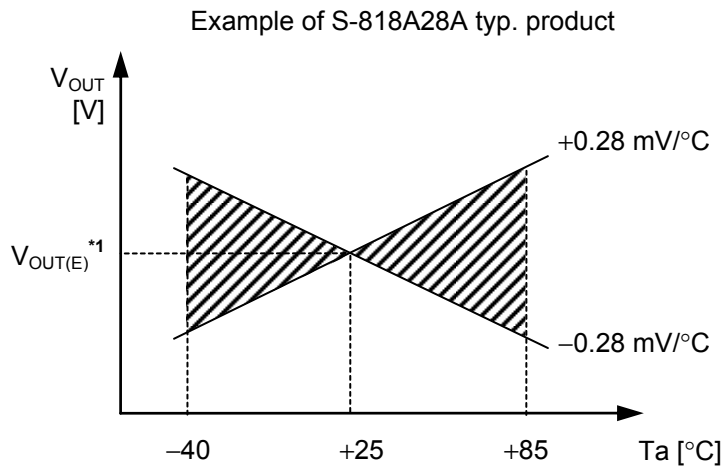

*1. $V_{OUT(E)}$ is the value of the output voltage measured at $T_a = +25^{\circ}C$.

Figure 11 Output voltage temperature coefficient range

A change in the temperature of the output voltage [mV/ $^{\circ}C$] is calculated using the following equation.

$$\frac{\Delta V_{OUT}}{\Delta T_a} [mV/^{\circ}C]^{*1} = V_{OUT(S)} [V]^{*2} \times \frac{\Delta V_{OUT}}{\Delta T_a \bullet V_{OUT}} [ppm/^{\circ}C]^{*3} \div 1000$$

- *1. Change in temperature of output voltage
- *2. Set output voltage
- *3. Output voltage temperature coefficient

■ **Operation**

1. Basic operation

Figure 12 shows the block diagram of the S-818 Series.

The error amplifier compares the reference voltage (V_{ref}) with feedback voltage (V_{fb}), which is the output voltage resistance-divided by feedback resistors (R_s and R_f). It supplies the gate voltage necessary to maintain the constant output voltage which is not influenced by the input voltage and temperature change, to the output transistor.

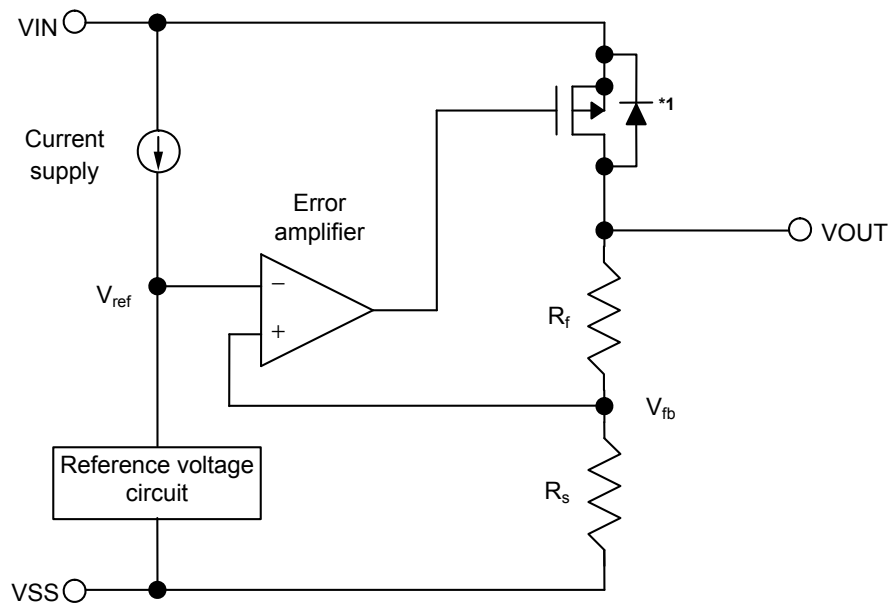

*1. Parasitic diode

*1. Parasitic diode

Figure 12 Block diagram

2. Output transistor

In the S-818 Series, a low on-resistance P-channel MOS FET is used as the output transistor. Be sure that V_{OUT} does not exceed $V_{IN}+0.3$ V to prevent the voltage regulator from being damaged due to reverse current flowing from VOUT pin through a parasitic diode to the VIN pin, when the potential of V_{OUT} became higher than V_{IN} .

3. ON/OFF pin

This pin starts and stops the regulator.

When the ON/OFF pin is set to OFF level, the entire internal circuit stops operating, and the built-in P-channel MOS FET output transistor between the VIN pin and the VOUT pin is turned off, reducing current consumption significantly. The VOUT pin becomes the VSS level due to the internally divided resistance of several MΩ between the VOUT pin and the VSS pin.

The structure of the ON/OFF pin is shown in **Figure 13**. Since the ON/OFF pin is neither pulled down nor pulled up internally, do not use it in the floating status. In addition, note that the current consumption increases if a voltage of 0.3 V to $V_{IN} - 0.3$ V is applied to the ON/OFF pin. When not using the ON/OFF pin, connect it to the VIN pin in the product A type, and connect it to the VSS pin in B type.

Table 6 ON/OFF pin function by product type

Product type	ON/OFF pin	Internal circuit	VOUT pin voltage	Current consumption
A	“H”: ON	Operate	Set value	I_{SS1}
A	“L”: OFF	Stop	V_{SS} level	I_{SS2}
B	“H”: OFF	Stop	V_{SS} level	I_{SS2}
B	“L”: ON	Operate	Set value	I_{SS1}

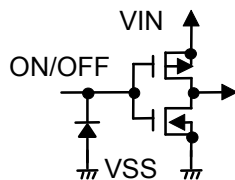

Figure 13 The structure of the ON/OFF Pin

■ Selection of Output Capacitor (CL)

The S-818 Series needs an output capacitor between the VOUT pin and the VSS pin for phase compensation. A small ceramic or an OS electrolyte capacitor of 2 μF or more can be used. When a tantalum or an aluminum electrolyte capacitor is used, the capacitance must be 2 μF or more and the ESR must be 10 Ω or less.

Attention should be paid not to cause an oscillation due to increase of ESR at low temperatures when an aluminum electrolyte capacitor is used.

Evaluate the performance including temperature characteristics before prototyping the circuit. Overshoot and undershoot characteristics differ depending upon the type of the output capacitor. Refer to the CL dependence data in “■ Transient Response Characteristics (S-818A30A, Typical data, Ta=25°C)”.

■ **Precautions**

- Wiring patterns for the VIN pin, the VOUT pin and GND should be designed so that the impedance is low. When mounting an output capacitor between the VOUT pin and the VSS pin (C_L) and a capacitor for stabilizing the input between the VIN pin and the VSS pin (C_{IN}), the distance from the capacitors to these pins should be as short as possible.
- Note that generally the output voltage may increase when a series regulator is used at low load current (10 mA or less).
- Generally a series regulator may cause oscillation, depending on the selection of external parts. The following conditions are recommended for the S-818 Series. However, be sure to perform sufficient evaluation under the actual usage conditions for selection, including evaluation of temperature characteristics.

Input capacitor (C_{IN}):	0.47 μ F or more
Output capacitor (C_L):	2 μ F or more
Equivalent series resistance (ESR):	10 Ω or less
Input series resistance (R_{IN}):	10 Ω or less

- The voltage regulator may oscillate when the impedance of the power supply is high and the input capacitor is small or an input capacitor is not connected.
- Overshoot may occur in the output voltage momentarily if the voltage is rapidly raised at power-on or when the power supply fluctuates. Sufficiently evaluate the output voltage at power-on with the actual device.
- The application conditions for the input voltage, the output voltage, and the load current should not exceed the package power dissipation.
- Do not apply an electrostatic discharge to this IC that exceeds the performance ratings of the built-in electrostatic protection circuit.
- In determining the output current, attention should be paid to the output current value specified in **Table 5** in the “■ **Electrical Characteristics**” and footnote *5 of the table.
- SII Semiconductor Corporation claims no responsibility for any disputes arising out of or in connection with any infringement by products including this IC of patents owned by a third party.

■ Characteristics (Typical data)

1. Output Voltage (V_{OUT}) vs. Output Current (I_{OUT}) (When load current increases)

S-818A20A

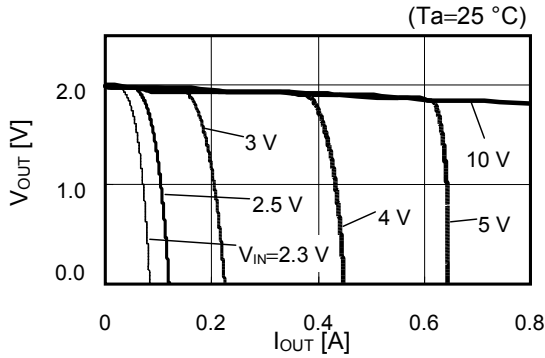

S-818A30A

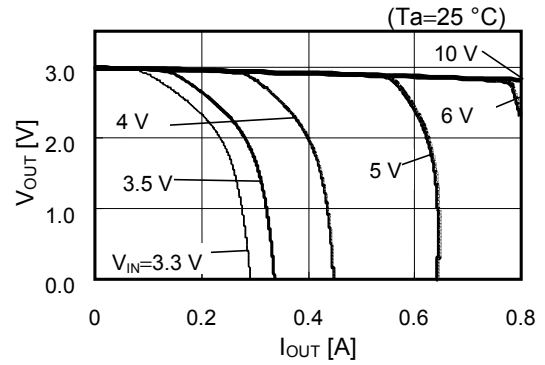

S-818A50A

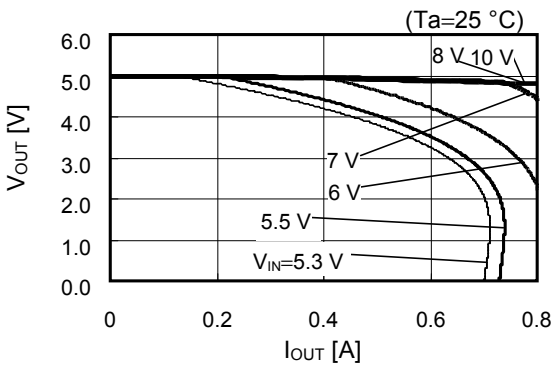

Remark In determining necessary output current, consider the following parameters:

1. Output current value in the “■ Electrical Characteristics” and footnote *5.
2. Power dissipation of the package

2. Output voltage (V_{OUT}) vs. Input voltage (V_{IN})

S-818A20A ($T_a=25^\circ\text{C}$)

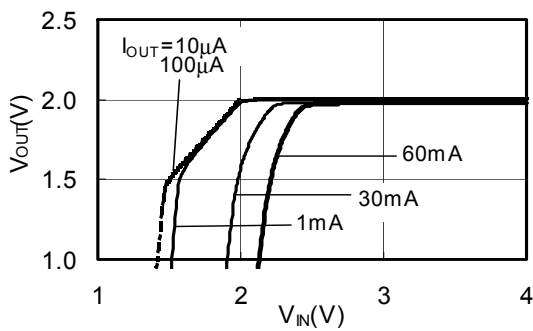

S-818A30A ($T_a=25^\circ\text{C}$)

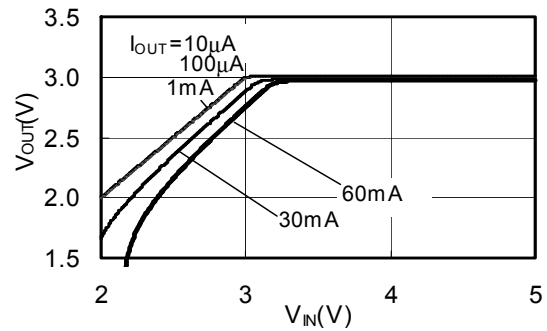

S-818A50A ($T_a=25^\circ\text{C}$)

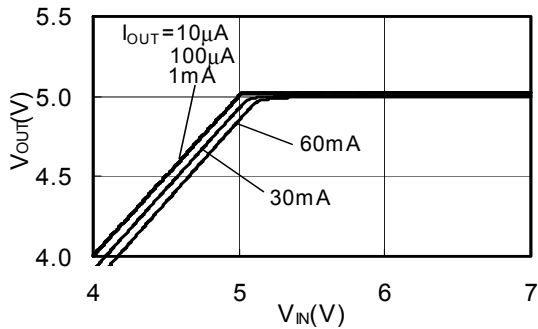

3. Maximum output current (I_{OUTmax}) vs. Input voltage (V_{IN})

S-818A20A

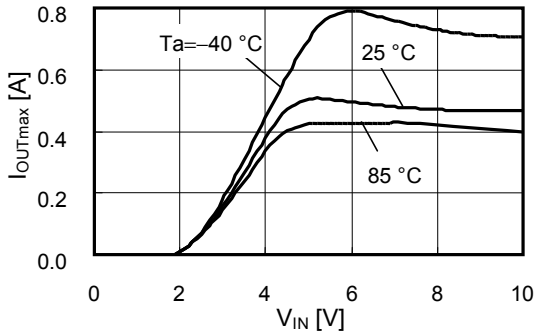

S-818A30A

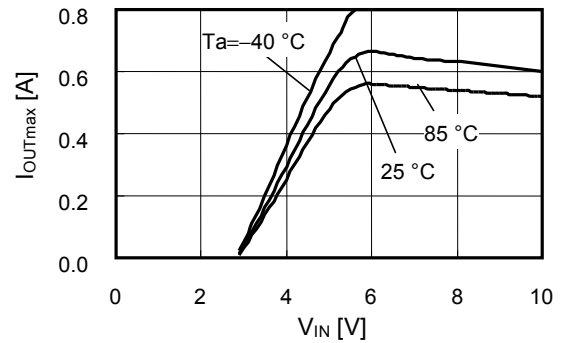

S-818A50A

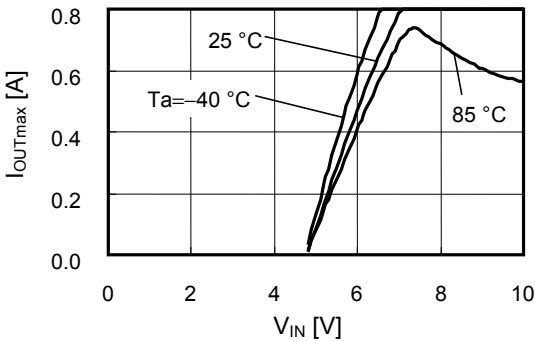

Remark In determining necessary output current, consider the following parameters:

1. Output current value in the "■ **Electrical Characteristics**" and footnote *5.
2. Power dissipation of the package

4. Dropout voltage (V_{drop}) vs. Output current (I_{OUT})

S-818A20A

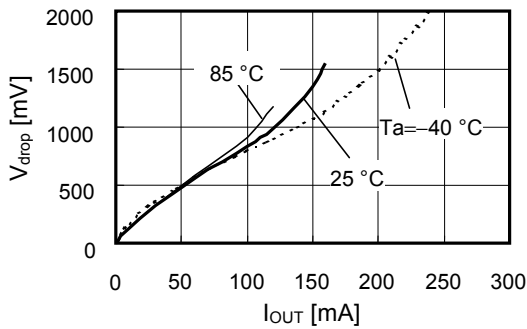

S-818A30A

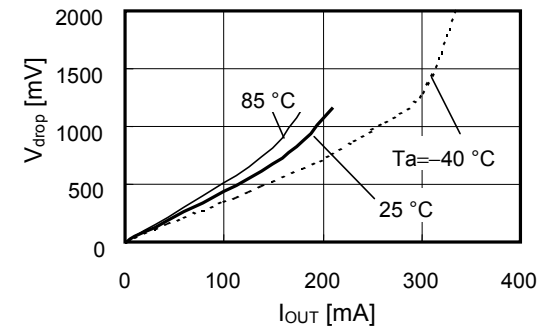

S-818A50A

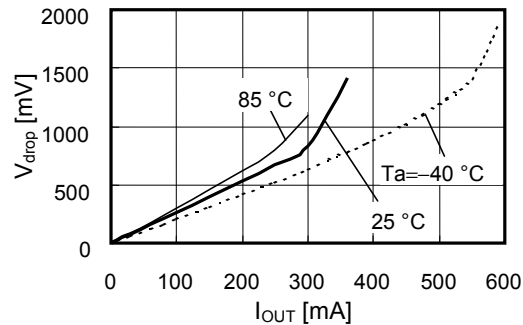

5. Output voltage (V_{OUT}) vs. Ambient temperature (T_a)

S-818A20A

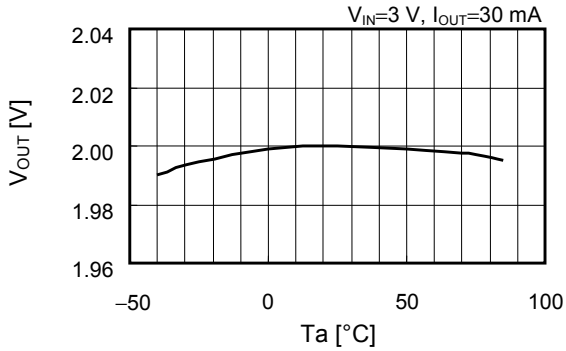

S-818A30A

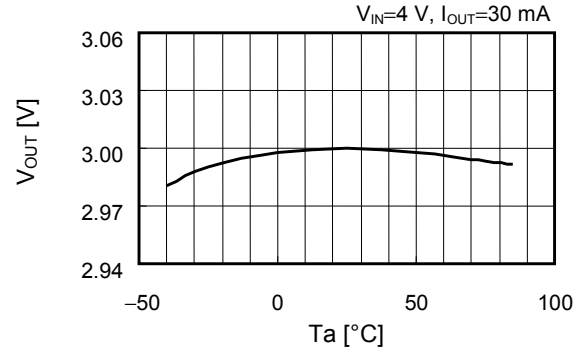

S-818A50A

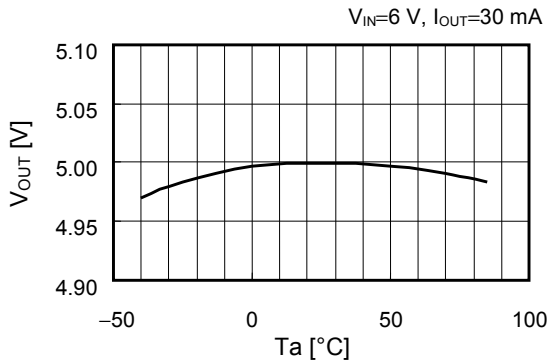

6. Line regulation (ΔV_{OUT1}) vs. Ambient temperature (T_a)

S-818A20A/S-818A30A/S-818A50A

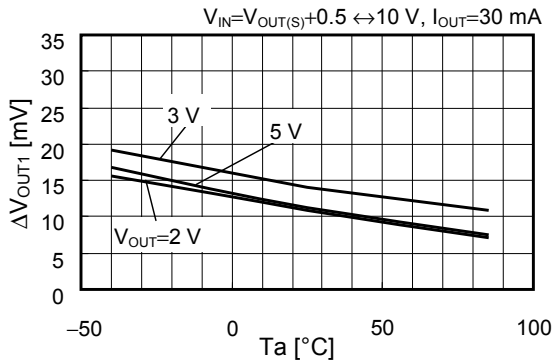

7. Load regulation (ΔV_{OUT3}) vs. Ambient temperature (T_a)

S-818A20A/S-818A30A/S-818A50A

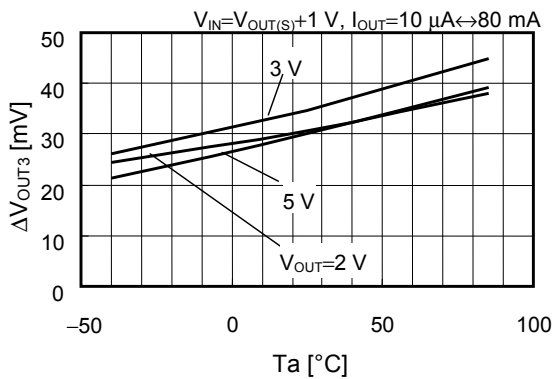

8. Current consumption (I_{SS1}) vs. Input voltage (V_{IN})

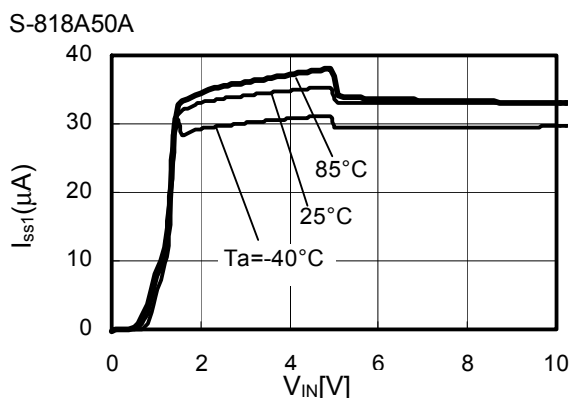
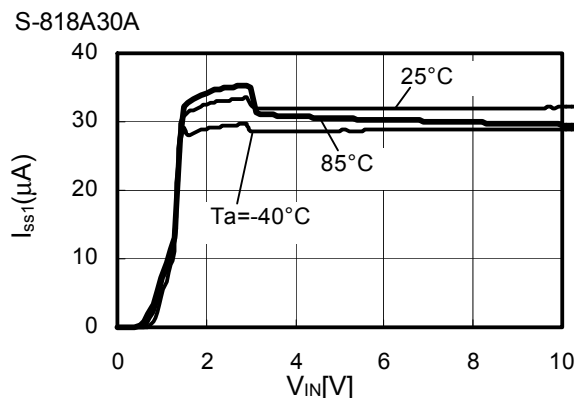
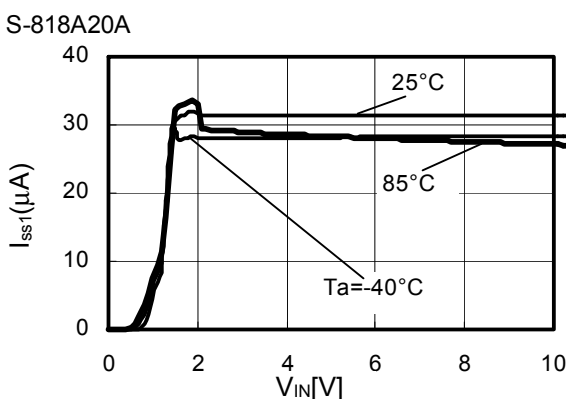

9. Threshold voltage of ON/OFF pin (V_{SH}/V_{SL}) vs. Input voltage (V_{IN})

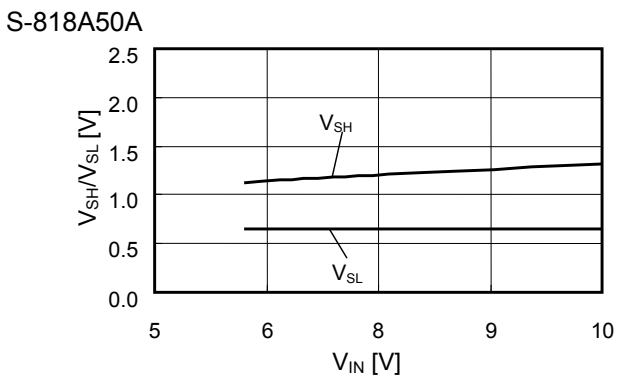
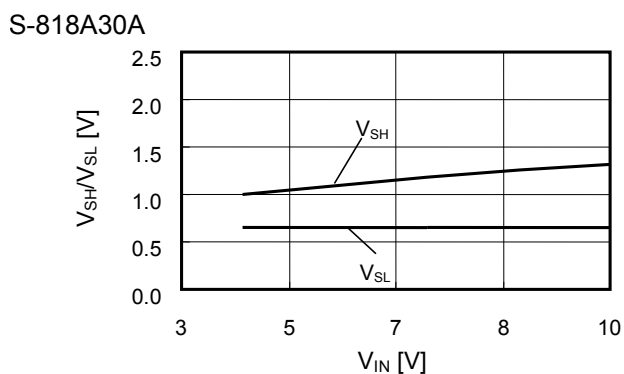
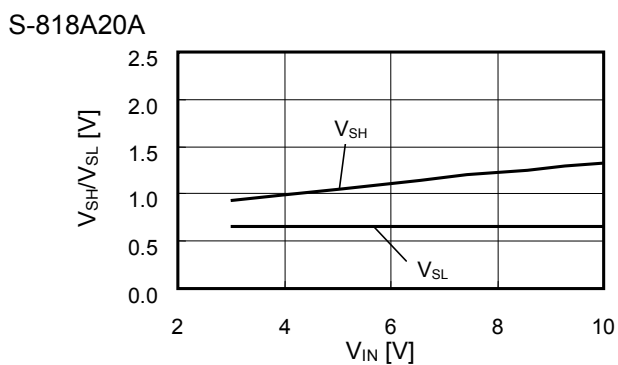

10. Ripple rejection

S-818A20A

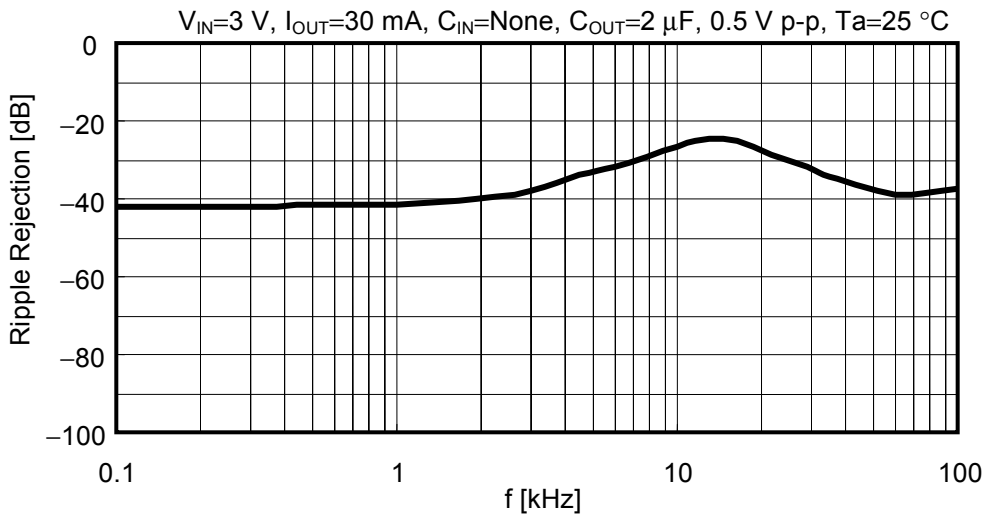

S-818A30A

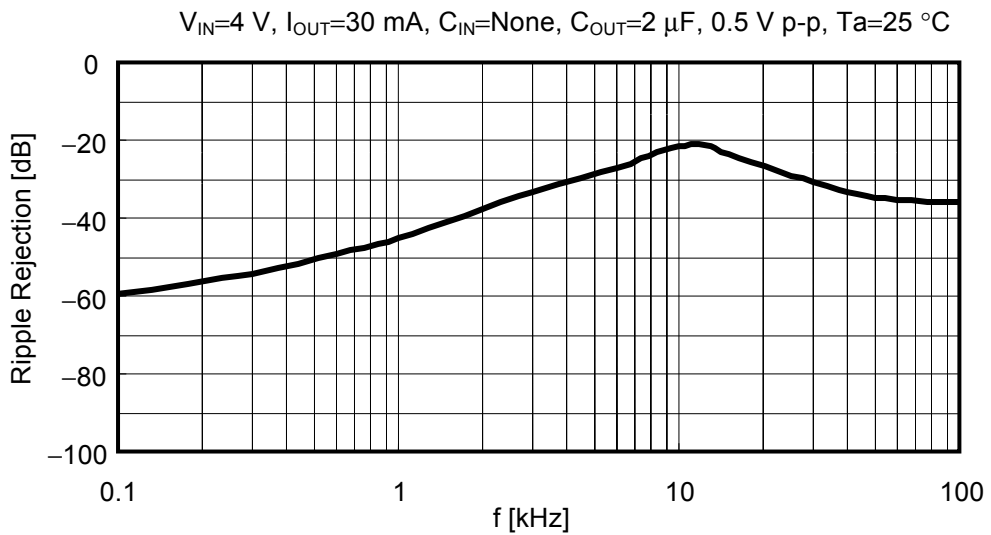

S-818A50A

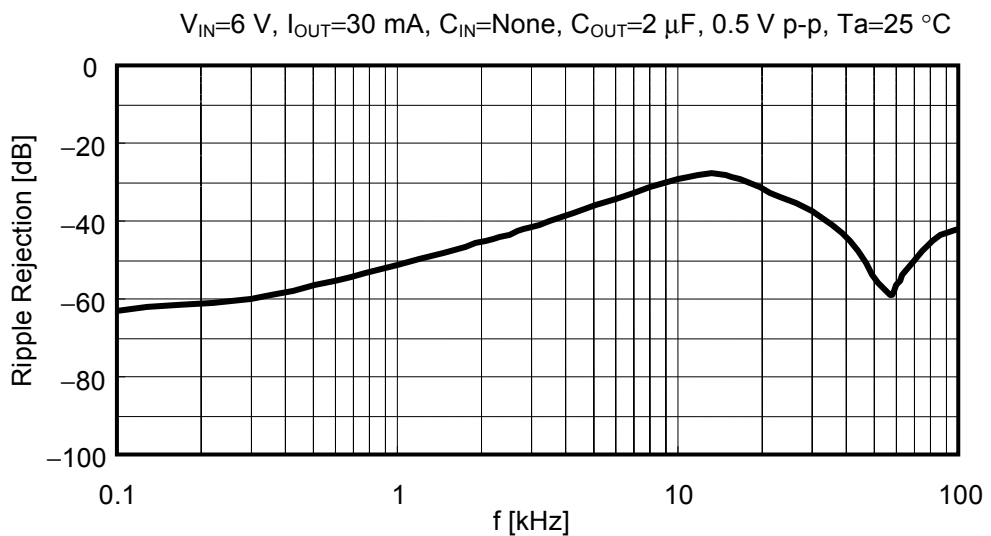

■ **Transient Response Characteristics (S-818A30A, Typical data, Ta=25°C)**



1. Power on

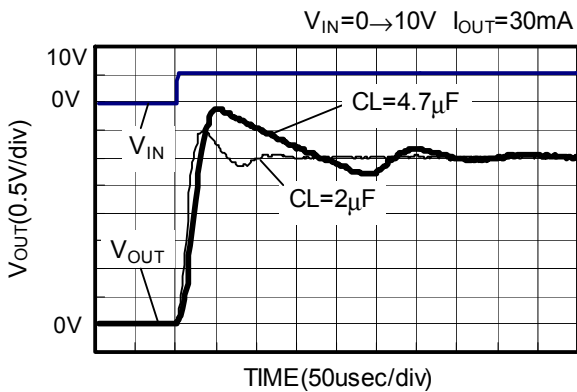

Load dependence of overshoot

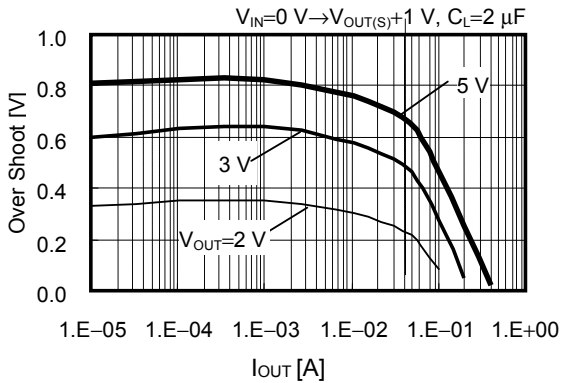

C_L dependence of overshoot

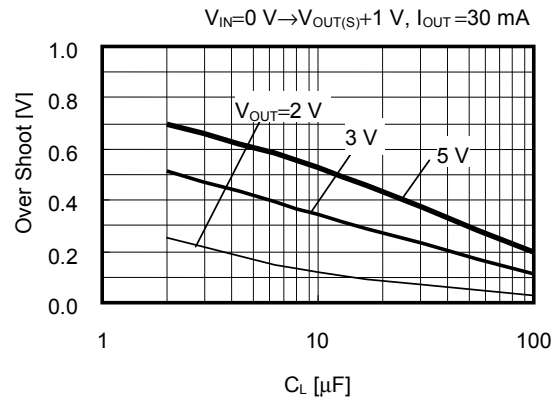

V_{DD} dependence of overshoot

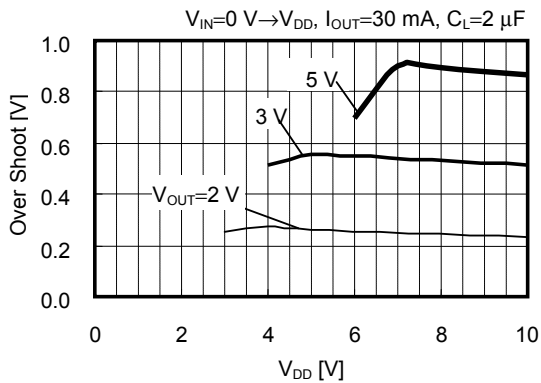

Temperature dependence of overshoot

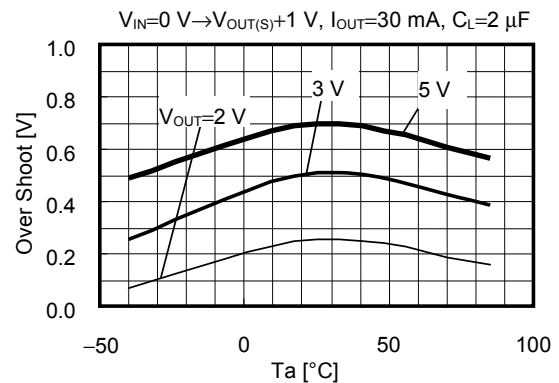

2. ON/OFF control

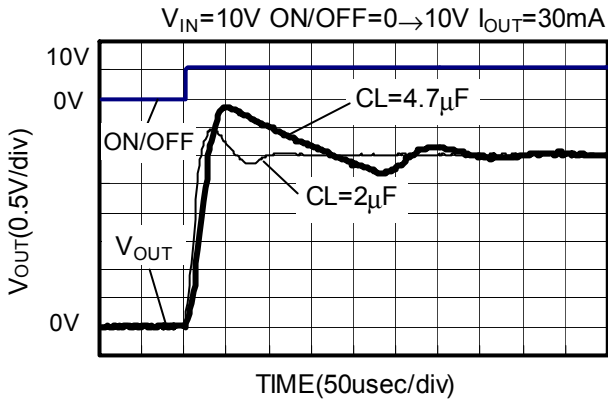

Load dependencies of overshoot

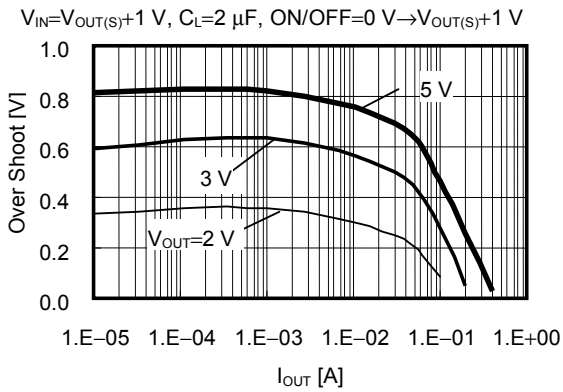

C_L dependence of overshoot

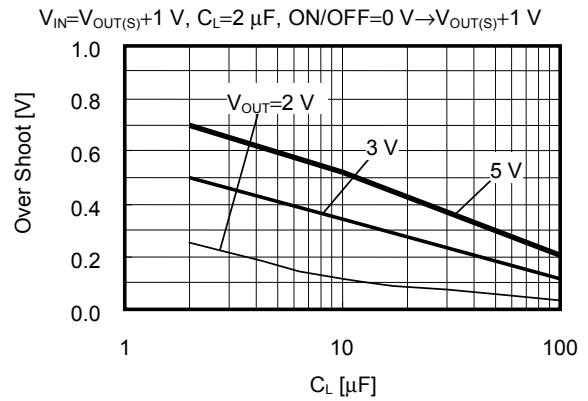

V_{DD} dependencies of overshoot

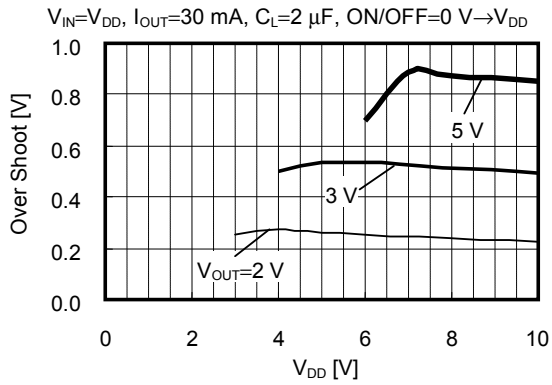

Temperature dependence of overshoot

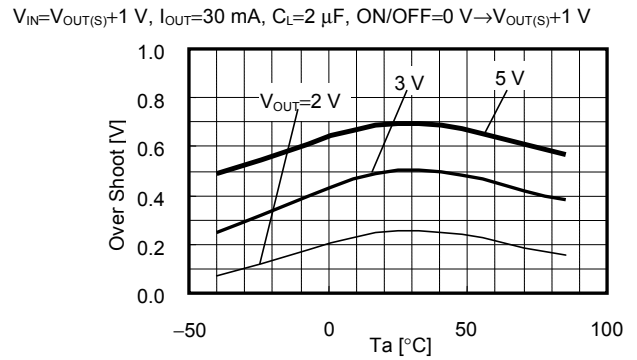

3. Power fluctuation

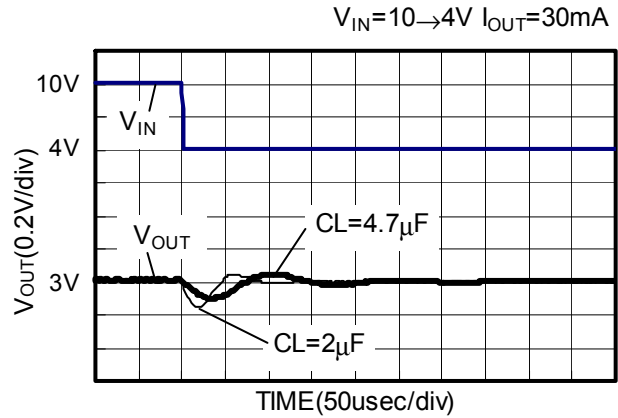
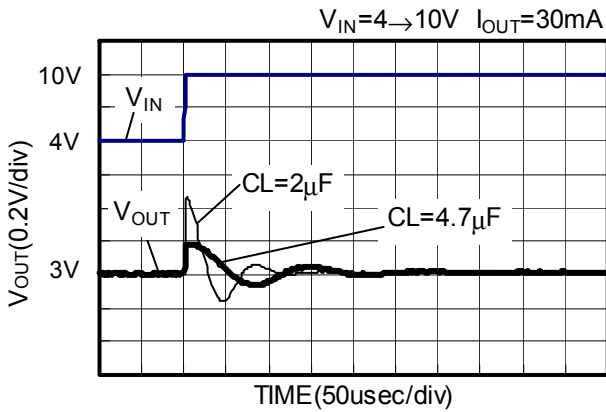

Load dependencies of overshoot

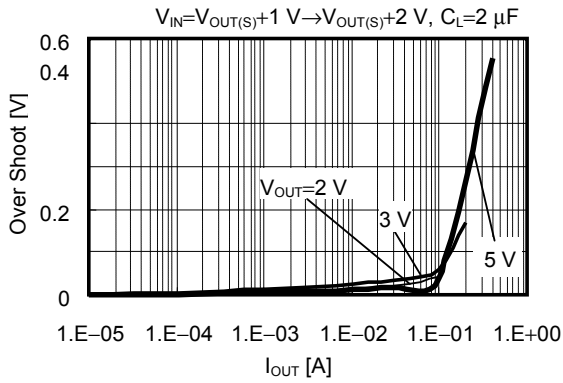

C_L dependence of overshoot

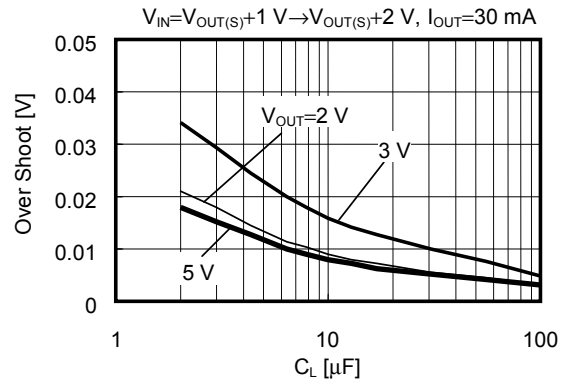

V_{DD} dependencies of overshoot

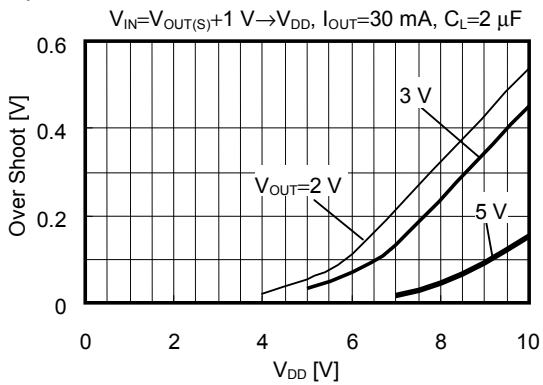

Temperature dependence

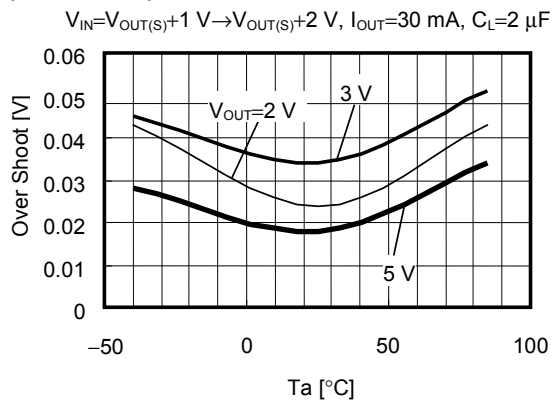

Load dependencies of undershoot

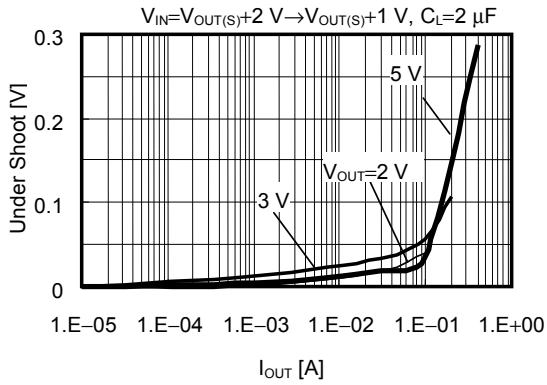

C_L dependence of undershoot

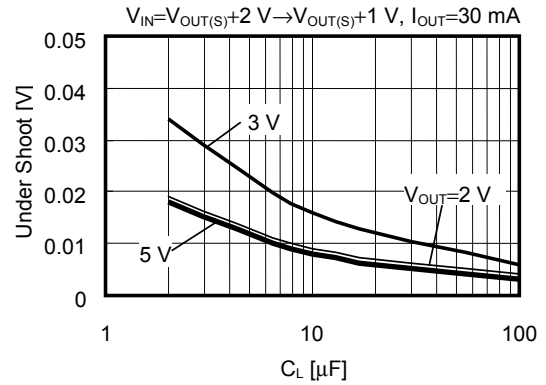

V_{DD} dependencies of undershoot

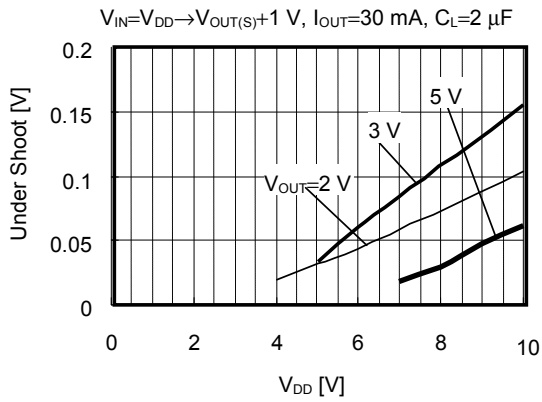

Temperature dependence of undershoot

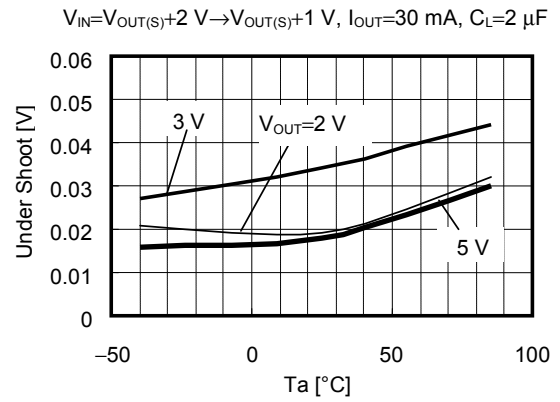

4. Load fluctuation

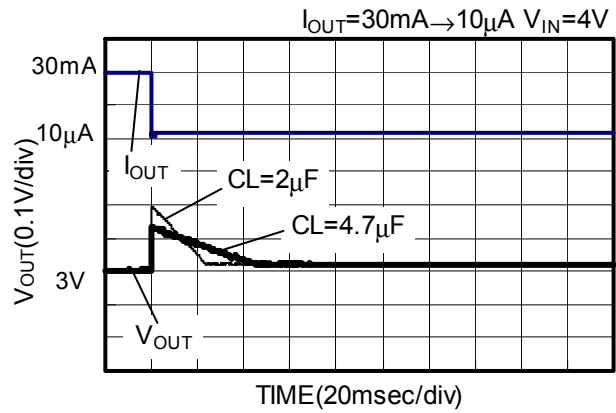
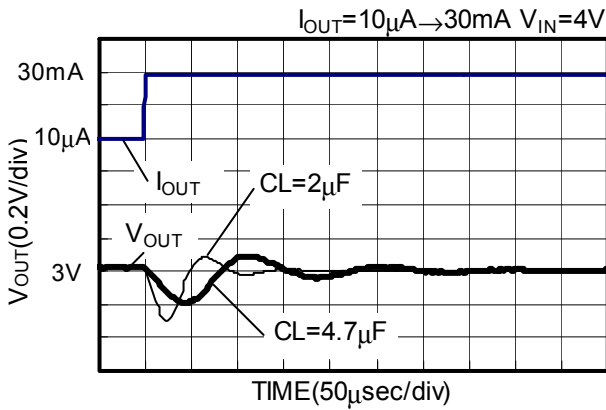

Load current dependence of load fluctuation overshoot C_L dependence of overshoot

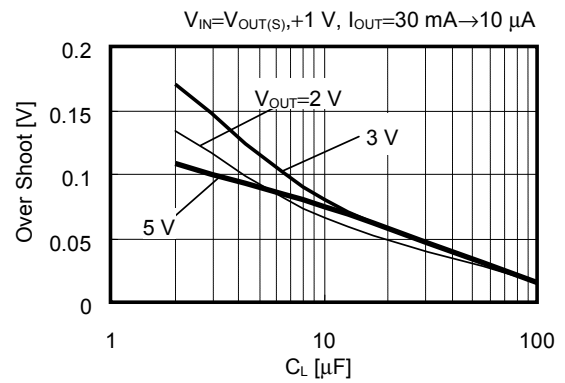
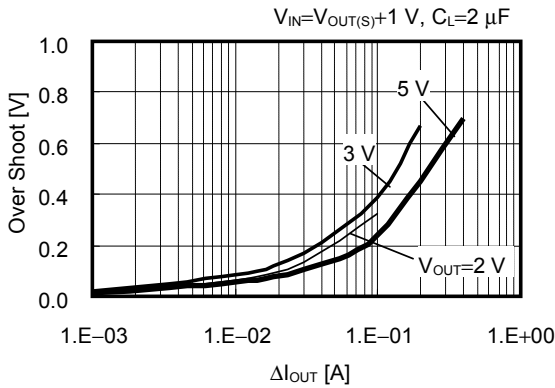

Remark ΔI_{OUT} shows larger load current at load current fluctuation while smaller current is fixed to 10 μA . For example $\Delta I_{OUT}=1.E-02$ (A) means load current fluctuation from 10 mA to 10 μA .

V_{DD} dependencies of overshoot

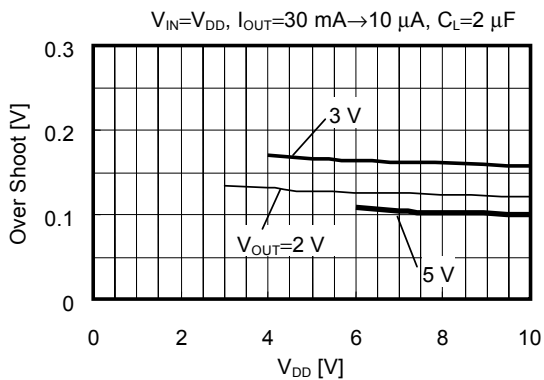

Temperature dependence of overshoot

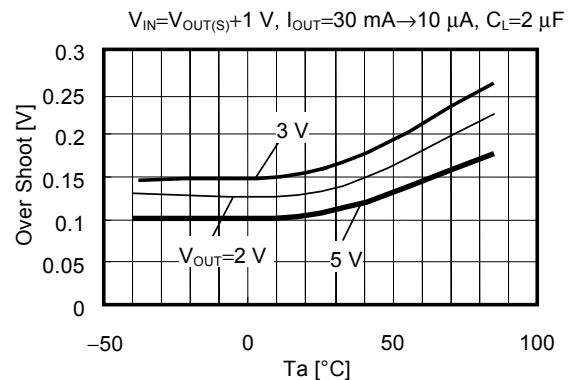

Load current dependence of load fluctuation undershoot C_L dependence of undershoot

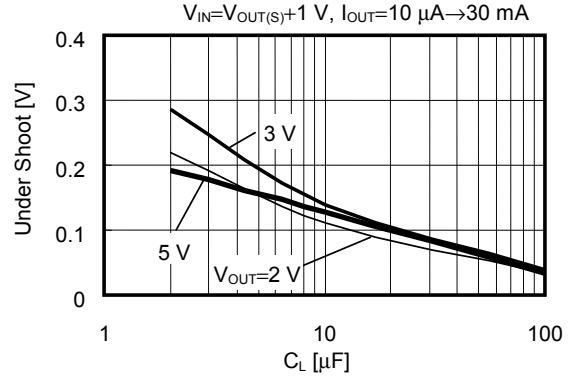
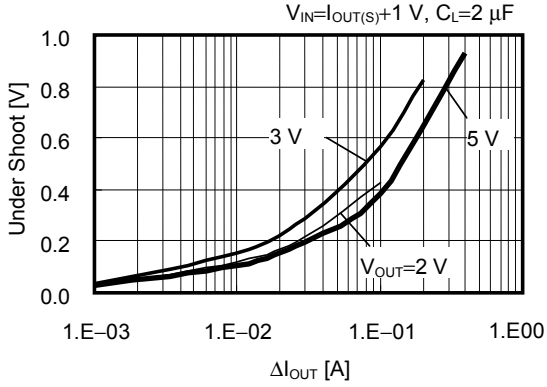

Remark ΔI_{OUT} shows larger load current at load current fluctuation while smaller current is fixed to $10\text{ }\mu\text{A}$. For example $\Delta I_{OUT}=1.E-02\text{ (A)}$ means load current fluctuation from $10\text{ }\mu\text{A}$ to 10 mA .

V_{DD} dependence of undershoot

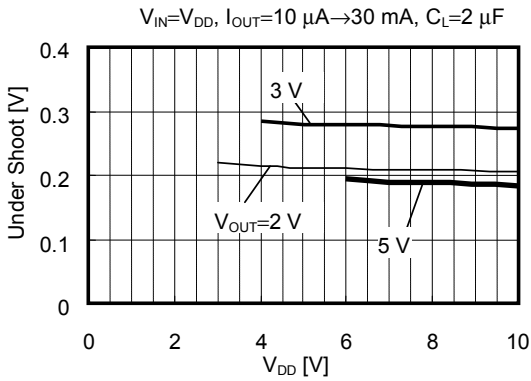

Temperature dependence of undershoot

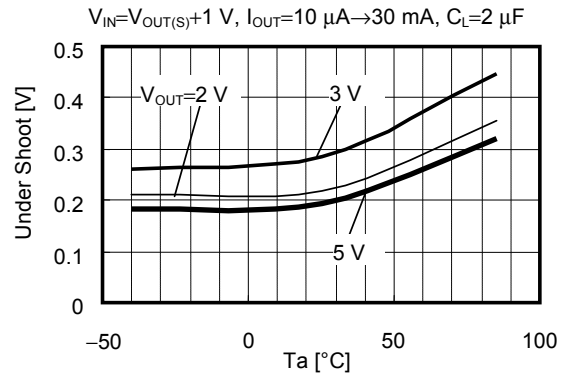

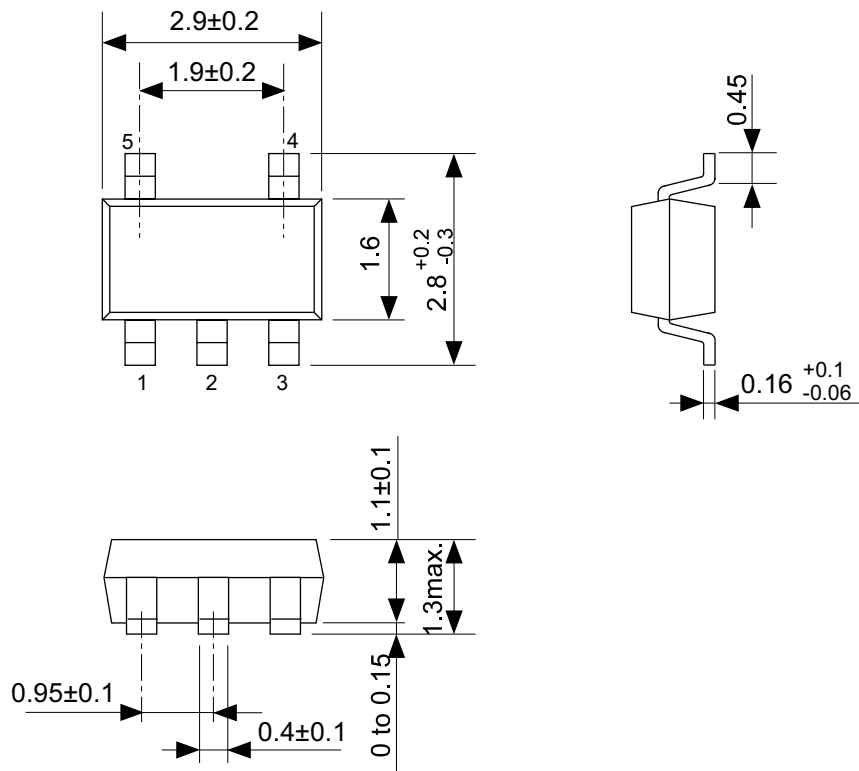

No. MP005-A-P-SD-1.2

TITLE	SOT235-A-PKG Dimensions
No.	MP005-A-P-SD-1.2
SCALE	
UNIT	mm
SII Semiconductor Corporation	

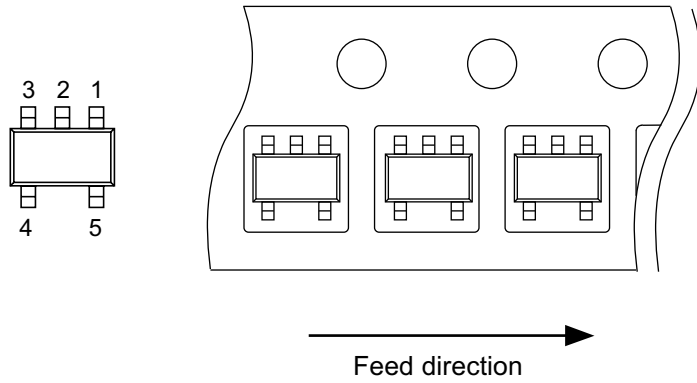
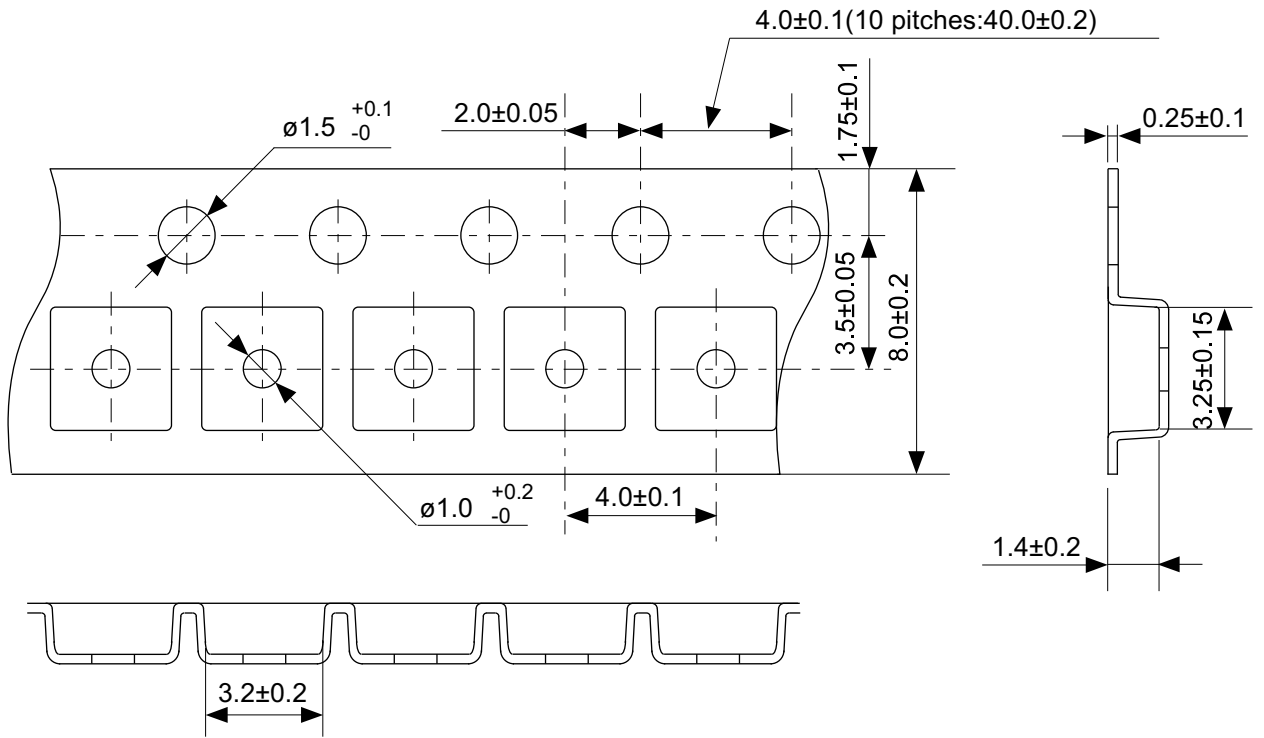

No. MP005-A-C-SD-2.1

TITLE	SOT235-A-Carrier Tape
No.	MP005-A-C-SD-2.1
SCALE	
UNIT	mm
SII Semiconductor Corporation	

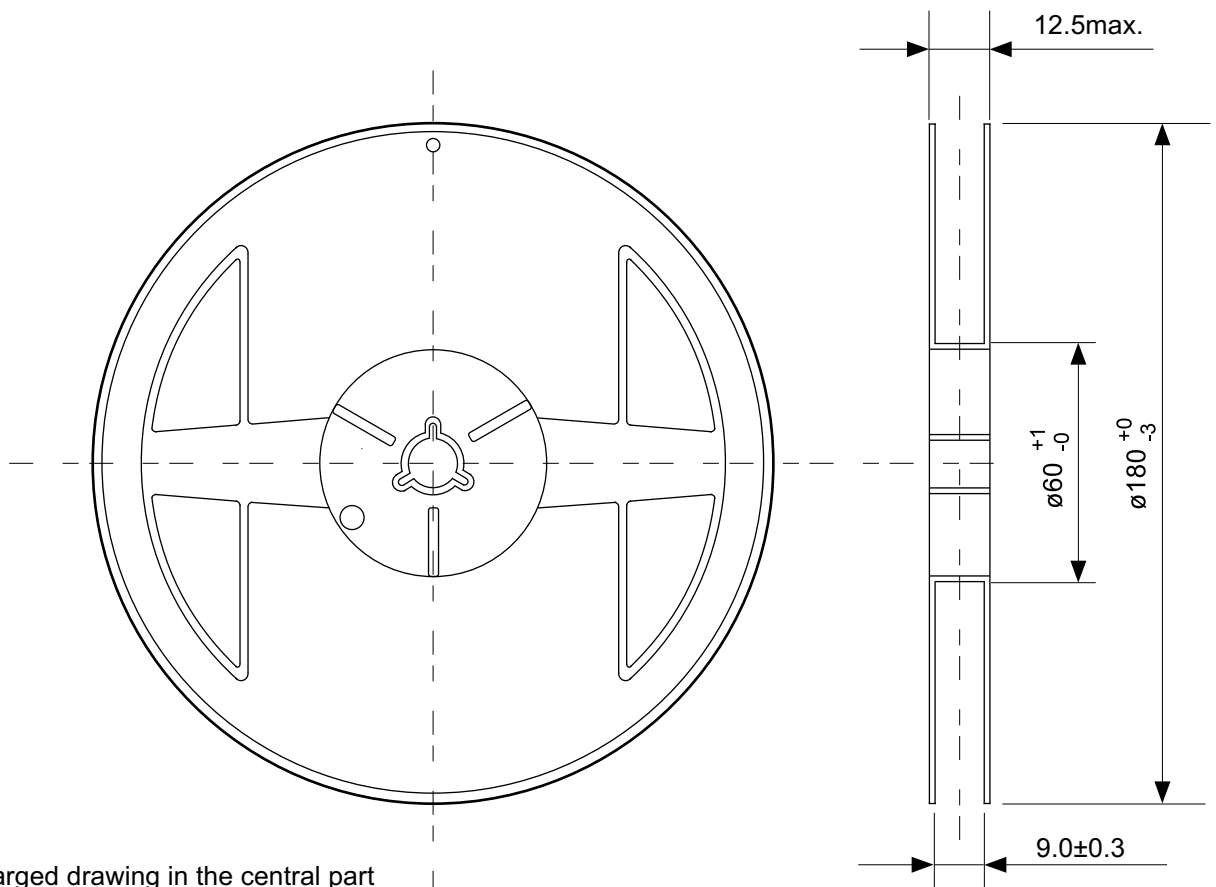

Enlarged drawing in the central part



No. MP005-A-R-SD-1.1

TITLE	SOT235-A-Reel		
No.	MP005-A-R-SD-1.1		
SCALE		QTY.	3,000
UNIT	mm		
SII Semiconductor Corporation			

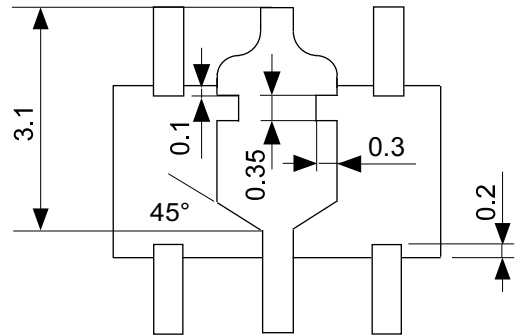
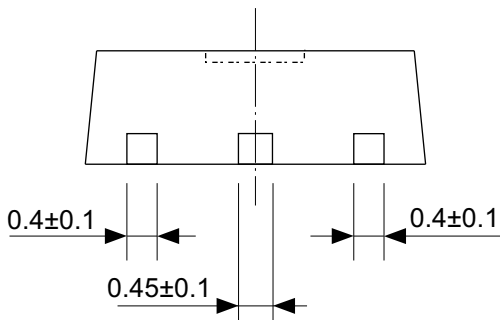
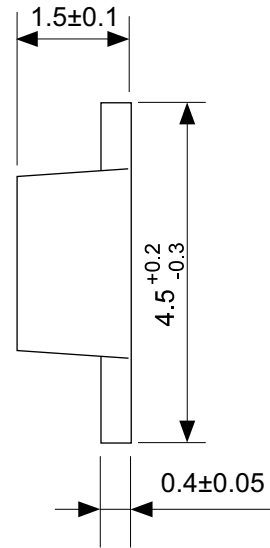
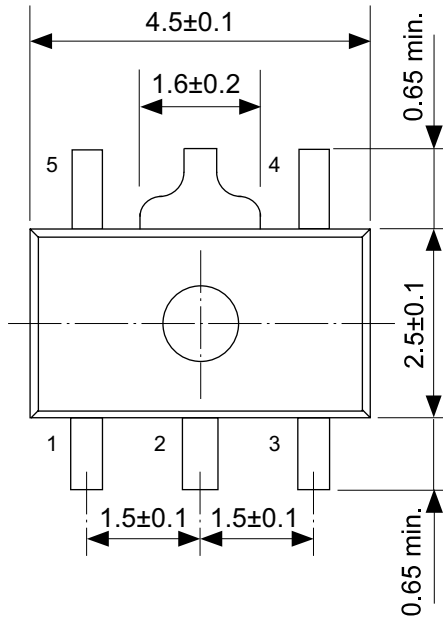

No. UP005-A-P-SD-1.1

TITLE	SOT895-A-PKG Dimensions
No.	UP005-A-P-SD-1.1
SCALE	
UNIT	mm
SII Semiconductor Corporation	

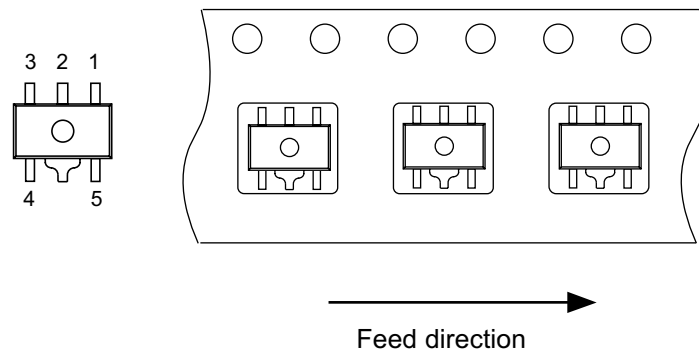
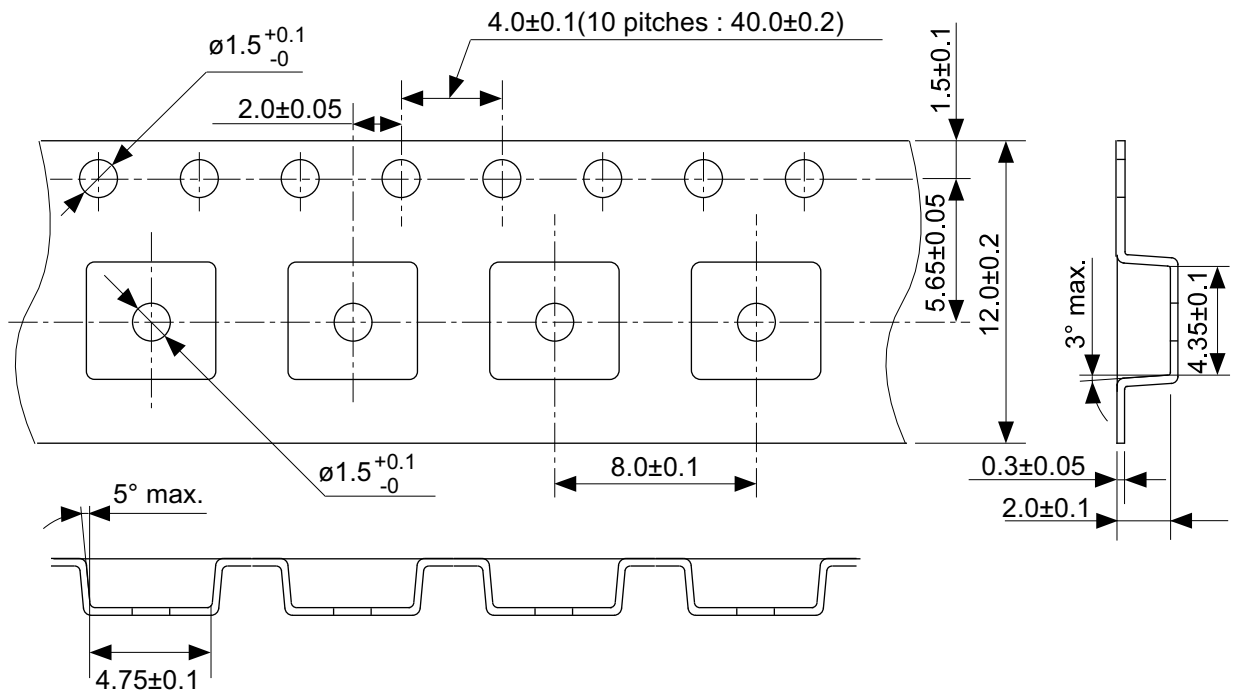

No. UP005-A-C-SD-1.1

TITLE	SOT895-A-Carrier Tape
No.	UP005-A-C-SD-1.1
SCALE	
UNIT	mm
SII Semiconductor Corporation	

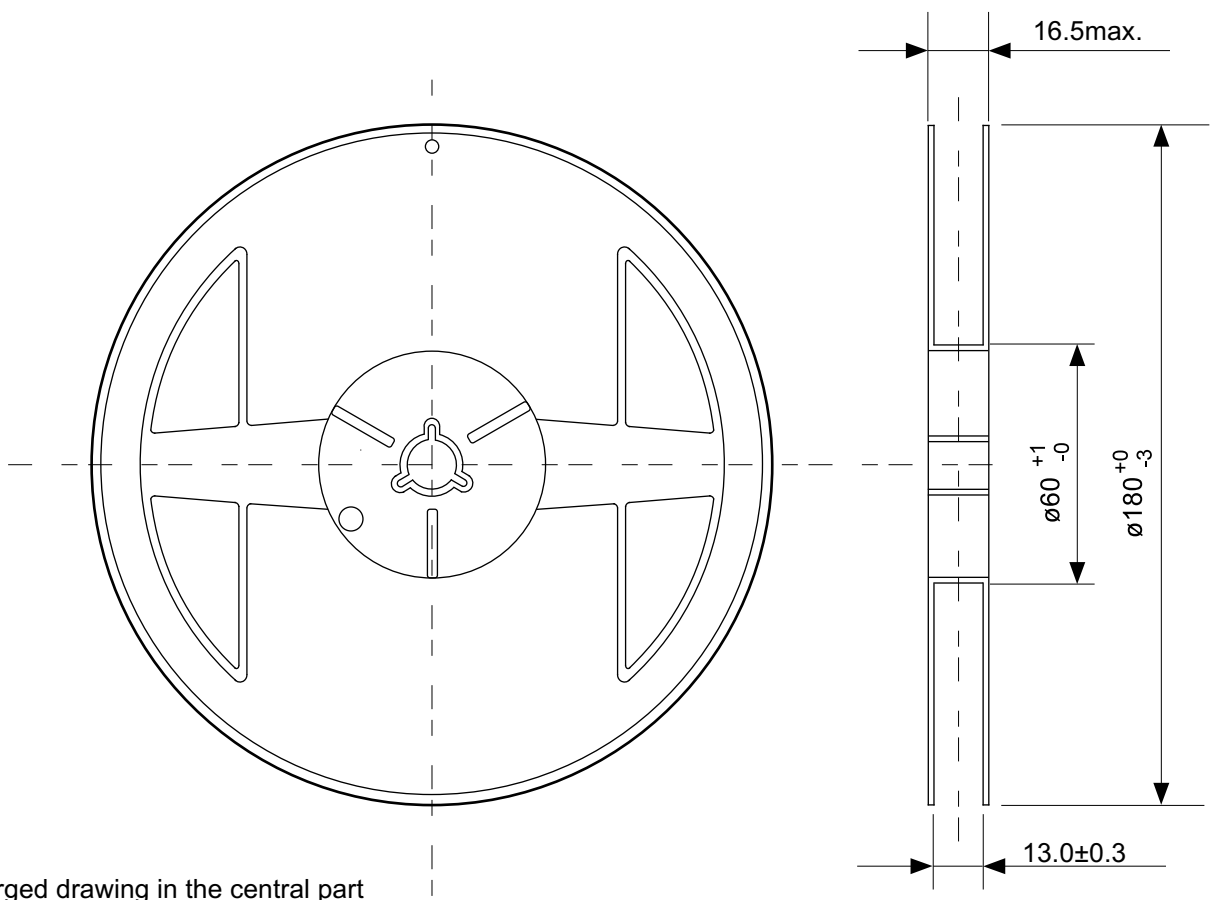

Enlarged drawing in the central part

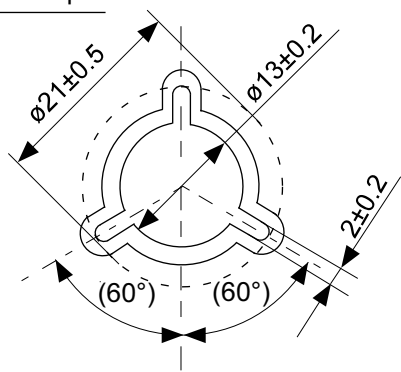

No. UP005-A-R-SD-1.1

TITLE	SOT895-A-Reel		
No.	UP005-A-R-SD-1.1		
SCALE		QTY.	1,000
UNIT	mm		
SII Semiconductor Corporation			

Disclaimers (Handling Precautions)

1. All the information described herein (product data, specifications, figures, tables, programs, algorithms and application circuit examples, etc.) is current as of publishing date of this document and is subject to change without notice.
2. The circuit examples and the usages described herein are for reference only, and do not guarantee the success of any specific mass-production design.
SII Semiconductor Corporation is not responsible for damages caused by the reasons other than the products or infringement of third-party intellectual property rights and any other rights due to the use of the information described herein.
3. SII Semiconductor Corporation is not responsible for damages caused by the incorrect information described herein.
4. Take care to use the products described herein within their specified ranges. Pay special attention to the absolute maximum ratings, operation voltage range and electrical characteristics, etc.
SII Semiconductor Corporation is not responsible for damages caused by failures and/or accidents, etc. that occur due to the use of products outside their specified ranges.
5. When using the products described herein, confirm their applications, and the laws and regulations of the region or country where they are used and verify suitability, safety and other factors for the intended use.
6. When exporting the products described herein, comply with the Foreign Exchange and Foreign Trade Act and all other export-related laws, and follow the required procedures.
7. The products described herein must not be used or provided (exported) for the purposes of the development of weapons of mass destruction or military use. SII Semiconductor Corporation is not responsible for any provision (export) to those whose purpose is to develop, manufacture, use or store nuclear, biological or chemical weapons, missiles, or other military use.
8. The products described herein are not designed to be used as part of any device or equipment that may affect the human body, human life, or assets (such as medical equipment, disaster prevention systems, security systems, combustion control systems, infrastructure control systems, vehicle equipment, traffic systems, in-vehicle equipment, aviation equipment, aerospace equipment, and nuclear-related equipment), excluding when specified for in-vehicle use or other uses. Do not use those products without the prior written permission of SII Semiconductor Corporation. Especially, the products described herein cannot be used for life support devices, devices implanted in the human body and devices that directly affect human life, etc.
Prior consultation with our sales office is required when considering the above uses.
SII Semiconductor Corporation is not responsible for damages caused by unauthorized or unspecified use of our products.
9. Semiconductor products may fail or malfunction with some probability.
The user of these products should therefore take responsibility to give thorough consideration to safety design including redundancy, fire spread prevention measures, and malfunction prevention to prevent accidents causing injury or death, fires and social damage, etc. that may ensue from the products' failure or malfunction.
The entire system must be sufficiently evaluated and applied on customer's own responsibility.
10. The products described herein are not designed to be radiation-proof. The necessary radiation measures should be taken in the product design by the customer depending on the intended use.
11. The products described herein do not affect human health under normal use. However, they contain chemical substances and heavy metals and should therefore not be put in the mouth. The fracture surfaces of wafers and chips may be sharp. Take care when handling these with the bare hands to prevent injuries, etc.
12. When disposing of the products described herein, comply with the laws and ordinances of the country or region where they are used.
13. The information described herein contains copyright information and know-how of SII Semiconductor Corporation.
The information described herein does not convey any license under any intellectual property rights or any other rights belonging to SII Semiconductor Corporation or a third party. Reproduction or copying of the information described herein for the purpose of disclosing it to a third-party without the express permission of SII Semiconductor Corporation is strictly prohibited.
14. For more details on the information described herein, contact our sales office.

1.0-2016.01

