

# Pulse Transformer with Single Secondary Winding

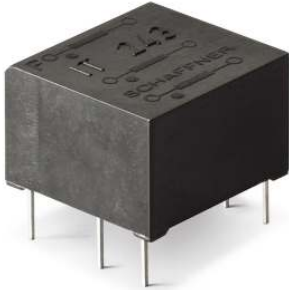

- | Galvanic separation of drive and power circuit
- | Voltage resistance up to 8 kV
- | Ignition current up to 3 A
- | Turns ratio up to 3:1



Approvals

**ROHS**

IT pulse transformers are designed to offer you galvanic isolation for transformer coupled gate drives. The IT series provides negligible delays and the possibility of voltage scaling. They are available with single or double secondary winding for multiple gate drives. Choosing the IT product line brings you the rapid availability of a standard gate drive transformer. A wide selection on turns ratio, ignition current and voltages are designed to offer you the desired standard product.

## Technical specifications

<b>Nominal operating voltage</b>	Up to 3000 V
<b>Ignition currents</b>	0.1 to 3 A @ 40 °C
<b>Max. partial discharge voltage</b>	1.5 x U <sup>nom</sup>
<b>Rise time</b>	0.3 to 2.3 μs
<b>Test voltage</b>	U <sub>p</sub> /50 Hz/2s max. according to VDE 110b
<b>Temperature range (operation and storage)</b>	-25 °C to +70 °C (25/70/21)
<b>Flammability corresponding to</b>	UL 94 V-0 listed materials
<b>Operating frequency</b>	40 kHz max. 500 kHz max. for data transmission



## Features and benefits

- | Galvanic separation
- | Voltage resistance up to 8 kV
- | Allows high potential difference voltage scaling
- | Optional grounded shields
- | Vacuum potting
- | Very low partial discharge effects
- | PCB through hole mounting or faston types
- | Custom-specific versions on request

## Typical applications

- | Gate drive circuit
- | Power supplies
- | Power converters
- | Frequency converters
- | Switching applications
- | DC/DC converters
- | Line coupling transformers in high-speed data transmission

## Pulse transformer selection table

Pulse transformer	Turns ratio	Ignition current $I_{ign}$ [A]	Voltage		Voltage time area $V_{0t}$ [V $\mu$ s]	Rise time $t_r$ [ $\mu$ s]	Inductance		Resistance		Coupling capacitance $C_k$ [pF]	Input/ Output connections		Weight [g]
			$U_{nom}$ [V]	$U_p$ [kV]			$L_p$ [mH]	$L_{str}$ [ $\mu$ H]	$R_p$ [ $\Omega$ ]	$R_s$ [ $\Omega$ ]				
<b>IT 155</b>	1:1	0.1	500	4	480	1	5	85	1.2	1.2	6	02		13
<b>IT 245</b>	1:1	0.1	750	4	500	1.2	8	100	1.48	1.48	10	02		6
<b>IT 237</b>	1:1	0.25	500	2.5	1100	1	25	35	1.9	2.2	50	02		14
<b>IT 239</b>	1:1	0.25	1000	6	300	2.3	3	80	0.9	0.9	5	02		13
<b>IT 255</b>	1:1	0.25	750	4	250	1.1	2.2	40	0.8	0.8	8	02		6
<b>IT 258</b>	1:1	1	750	3.2	250	0.25	2.5	3	0.62	0.75	80	02		6
<b>IT 370</b>	1:1	1	1000	5	4000	0.6	0.3	6	0.16	0.18	40	02		71
<b>IT 364*</b>	1:1	3	3000	8	5000	1.7	1.5	10	0.16	0.14	35		05	220
<b>IT 246</b>	2:1	0.1	750	4	200	0.4	7	35	2.1	1.1	7	02		6
<b>IT 248</b>	2:1	0.25	750	3.2	350	2.2	17	80	3.2	1.6	9	02		6
<b>IT 260</b>	3:1	0.1	500	3.2	200	0.3	12	30	2	0.8	8	02		6

\* Not suitable for PCB-mounting.

Explanations:

-  $t_r$  rise time at given load resistor R and 70% of the output pulse height.

-  $L_p$  primary inductance measured at 1 kHz (secondary coil open).

-  $L_{str}$  stray inductance measured at the secondary side, short circuit at the primary side. If there are several secondary coils only one at the time is connected (measuring frequency 10 kHz).

- The ignition current is a set peak value where the voltage drop over the coil resistance is still insignificant (mostly below 1 V).

## Mechanical data

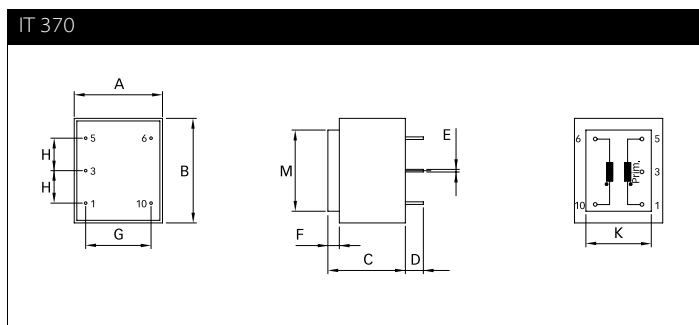
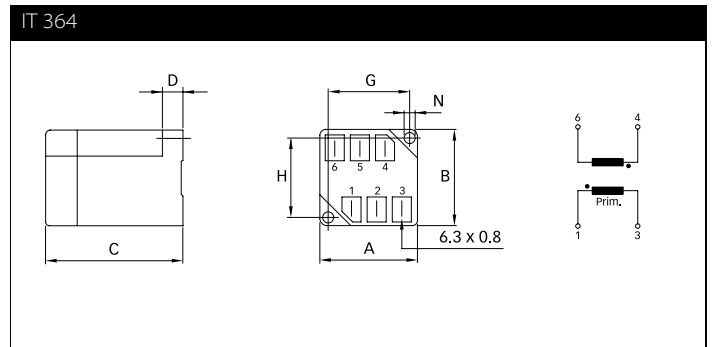
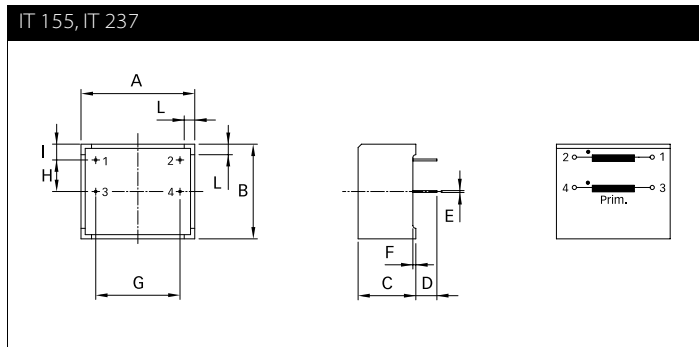
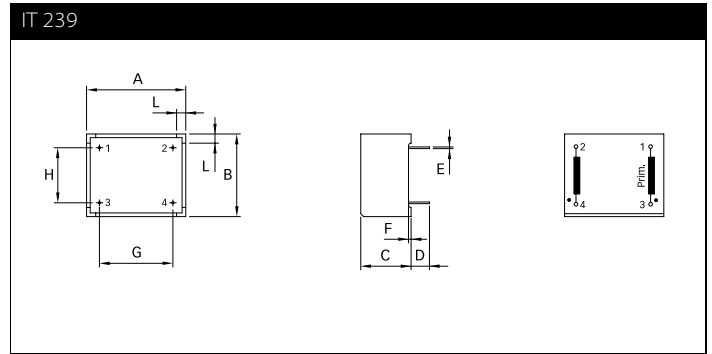
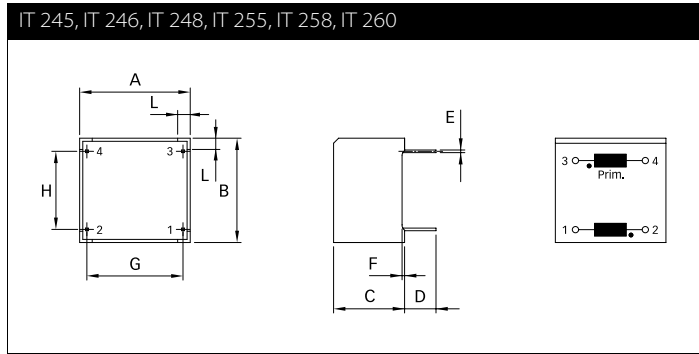

## Dimensions

	IT 245	IT 246	IT 248	IT 255	IT 258	IT 260	IT 239	IT 155	IT 237	IT 364	IT 370	Tol.
<b>A</b>	17.6*	17.6*	17.6*	17.6*	17.6*	17.6*	27	27	27	50	27	±0.2
<b>B</b>	16.7*	16.7*	16.7*	16.7*	16.7*	16.7*	22.5	22.5	22.5	50	32.2	±0.2
<b>C</b>	11.3*	11.3*	11.3*	11.3*	11.3*	11.3*	13.7	13.7	13.7	60	23.7	±0.2
<b>D</b>	5	5	5	5	5	5	5	5	5	10*	5.5	+1/-0
<b>E</b>	0.42	0.42	0.42	0.42	0.42	0.42	0.45	0.45	0.45		Ø0.8	
<b>F</b>	0.4	0.4	0.4	0.4	0.4	0.4	0.7	0.7	0.7		3.5	
<b>G</b>	15.3	15.3	15.3	15.3	15.3	15.3	20	20	20	42	20	±0.2
<b>H</b>	12.5	12.5	12.5	12.5	12.5	12.5	15	7.5	7.5	42	10	±0.2
<b>I</b>								3.5	3.5			±0.2
<b>L</b>	2	2	2	2	2	2	2.5	2.5	2.5			
<b>M</b>											25	±0.2
<b>N</b>										Ø4.2		

\* Tolerance is ±0.1

All dimensions in mm; 1 inch = 25.4 mm  
Tolerances according: ISO 2768-m / EN 22768-m

Please visit [www.schaffner.com](http://www.schaffner.com) to find more details on connectors.



## Headquarters, global innovation and development center

### Switzerland

#### Schaffner Group

Nordstrasse 11  
4542 Luterbach  
T +41 32 6816 626  
F +41 32 6816 630  
[info@schaffner.com](mailto:info@schaffner.com)  
<http://www.schaffner.com>



## Sales and application centers

### China

#### Schaffner EMC Ltd. Shanghai

T20-3, No 565 Chuangye Road  
Pudong New Area  
201201 Shanghai  
T +86 21 3813 9500  
F +86 21 3813 9501 / 02  
[cschina@schaffner.com](mailto:cschina@schaffner.com)  
<http://www.schaffner.com.cn/>

### Finland

#### Schaffner Oy

Sauvonrinne 19 H  
08500 Lohja  
T +358 19 35 72 71  
[finlandsales@schaffner.com](mailto:finlandsales@schaffner.com)

### France

#### Schaffner EMC S.A.S.

112, Quai de Bezons  
Boîte postale 133  
95103 Argenteuil  
T +33 1 34 34 30 60  
F +33 1 39 47 02 28  
[francesales@schaffner.com](mailto:francesales@schaffner.com)

### Germany

#### Schaffner Deutschland GmbH

Schoemperlenstrasse 12B  
76185 Karlsruhe  
T +49 721 56910  
F +49 721 569110  
[germanysales@schaffner.com](mailto:germanysales@schaffner.com)

### Italy

#### Schaffner EMC S.r.l.

Via Galileo Galilei 47  
20092 Cinisello Balsamo (MI)  
T +39 02 66 04 30 45/47  
F +39 02 61 23 943  
[italysales@schaffner.com](mailto:italysales@schaffner.com)

### Japan

#### Schaffner EMC K.K.

1-32-12, Kamiyama, Setagaya-ku  
7F Mitsui-seimei Sangenjaya Bldg.  
154-0011 Tokyo  
T +81 3 5712 3650  
F +81 3 5712 3651  
[japansales@schaffner.com](mailto:japansales@schaffner.com)  
<http://www.schaffner.jp>

### Singapore

#### Schaffner EMC Pte Ltd.

Blk 3015A Ubi Road 1  
05-09 Kampong Ubi Industrial Estate  
408705 Singapore  
T +65 6377 3283  
F +65 6377 3281  
[singaporesales@schaffner.com](mailto:singaporesales@schaffner.com)

### Spain

#### Schaffner EMC España

Calle Caléndula 93  
Miniparc III, Edificio E  
El Soto de la Moraleja  
Alcobendas  
28109 Madrid  
T +34 618 176 133  
[spainsales@schaffner.com](mailto:spainsales@schaffner.com)

### Sweden

#### Schaffner EMC AB

Turebergstorg 1, 6  
19147 Sollentuna  
T +46 8 5792 1121 / 22  
F +46 8 92 96 90  
[swedensales@schaffner.com](mailto:swedensales@schaffner.com)

### Switzerland

#### Schaffner EMV AG

Nordstrasse 11  
4542 Luterbach  
T +41 32 6816 626  
F +41 32 6816 641  
[sales@schaffner.ch](mailto:sales@schaffner.ch)

### Taiwan R.O.C.

#### Schaffner EMV Ltd.

6 Floor, No. 413  
Rui Guang Road  
114 Neihu District Taipei City  
T +886 2 87525050  
F +886 2 87518086  
[taiwansales@schaffner.com](mailto:taiwansales@schaffner.com)

### Thailand

#### Schaffner EMC Co. Ltd.

Northern Region Industrial Estate  
67 Moo 4 Tambon Ban Klang  
Amphur Muang P.O. Box 14  
51000 Lamphun  
T +66 53 58 11 04  
F +66 53 58 10 19  
[thailandsales@schaffner.com](mailto:thailandsales@schaffner.com)

### UK

#### Schaffner Ltd.

5 Ashville Way  
Molly Millars Lane  
Wokingham  
RG41 2PL Berkshire  
T +44 118 9770070  
F +44 118 9792969  
[uksales@schaffner.com](mailto:uksales@schaffner.com)  
<http://www.schaffner.uk.com>

### USA

#### Schaffner EMC Inc.

52 Mayfield Avenue  
08837 Edison, New Jersey  
T +1 800 367 5566  
T +1 732 225 9533  
F +1 732 225 4789  
[usasales@schaffner.com](mailto:usasales@schaffner.com)  
<http://www.schaffner.com/us>

#### Schaffner MTC LLC

6722 Thirlane Road  
24019 Roanoke, Virginia  
T +1 276 228 7943  
F +1 276 228 7953  
<http://www.schaffner-mtc.com>

#### Schaffner Trencos LLC

2550 Brookpark Road  
44134 Cleveland, Ohio  
T +1 216 741 5282  
F +1 216 741 4860  
[www.schaffner-trencos.com](http://www.schaffner-trencos.com)

To find your local partner within Schaffner's global network: [www.schaffner.com](http://www.schaffner.com)

© 2014 Schaffner Group

The content of this document has been carefully checked and understood. However, neither Schaffner nor its subsidiaries assume any liability whatsoever for any errors or inaccuracies of this document and the consequences thereof. Published specifications are subject to change without notice. Product suitability for any area of application must ultimately be determined by the customer. In all cases, products must never be operated outside their published specifications. Schaffner does not guarantee the availability of all published products. This disclaimer shall be governed by substantive Swiss law and resulting disputes shall be settled by the courts at the place of business of Schaffner Holding AG. Latest publications and a complete disclaimer can be downloaded from the Schaffner website. All trademarks recognized.