



# Signal lamps

	<b>Page</b>
<b>Signal lamps with integrated LED</b>	<b>3 - 3</b>
Signal lamps with integrated LED - 5 mm	3 - 4
Signal lamps with integrated LED - 7.0 mm	3 - 8
Signal lamps with integrated LED - 9.1 mm	3 - 10
Signal lamps with integrated LED - 10 mm	3 - 12
RF 15 - Signal indicator	3 - 16
RF 19 - Signal indicator	3 - 18
RG 85 III - Signal indicator, without lens	3 - 22
<b>Signal lamps with integrated lamp</b>	<b>3 - 25</b>
Signal lamps with integrated filament lamp - 5 mm	3 - 26
Signal lamps with integrated filament/neon lamp - 7 mm	3 - 28
Signal lamps with integrated filament/neon lamp - 10 mm	3 - 30
Signal lamps with integrated filament/neon lamp - 14 mm	3 - 36
<b>Signal lamps with lamp socket</b>	<b>3 - 39</b>
8 mm Series - Signal lamp	3 - 42
Signal lamps with lamp socket - W 2 x 4.6d, 9.1 mm	3 - 44
Signal lamps with lamp socket - T 4.6, 9.1 mm	3 - 46
Signal lamps with lamp socket - W 2x4.6d, 11.1 mm	3 - 48
Signal lamps with lamp socket - BA 9s (MBC/MCC), 16.2 mm	3 - 50
Signal lamps with lamp socket - E 10 (MES), 16.2 mm	3 - 52
LUMOTAST FK - Signal lamp	3 - 56
LUMOTAST 25 - Signal lamp	3 - 60
LUMOTAST 75 IP40 - Signal lamp with lamp socket T 4.5	3 - 64
LUMOTAST 75 IP65 - Signal lamp	3 - 68
RAFIX 16 - Signal indicator	3 - 74
RAFIX 16 F - Signal indicator	3 - 80
Signal lamps with lamp socket - BA 9s (MBC/MCC), 18.2 mm	3 - 84
Signal lamps with lamp socket - E 14, 22.3 mm	3 - 86
RAFIX 22 QR - Signal indicator	3 - 88
RAFIX 22 FS - Signal indicator	3 - 92
Signal lamps with lamp socket - E 14, 30.5 mm	3 - 96
Signal lamps with lamp socket - BA 15d, 30.5 mm	3 - 98
<b>Panel mounting sockets</b>	<b>3 - 101</b>
Panel mounting sockets - W 2 x 4.6d	3 - 102
Panel mounting sockets - Tubular lamp holders	3 - 104
Panel mounting sockets - BA 15d	3 - 106

## General information

### Signal Lamps with integral lamps/LED

The soldered lamps/LED without base cannot be replaced.

### Signal Lamps with lamp socket

An integral lamp socket allows replacement of lamps/LED of the appropriate type.

### Filament operating life

Operating life specifications refer to AC voltage operation. If operated with DC voltage, these values are reduced by 40%.

### Color and lenses

**transparent** = clear, grooved on inner surface for better light diffusion

**opaque** = translucent but not clear

### Neon lamps

Neon lamps may glow on a short time after having been switched off, for example in combination with long wires.

### Standard mounting dimensions

We recommend use of mounting hole diameters 16, 22 and 30 mm, as these comply with international standard recommendations and DIN standards.

### Limit values

The voltage specified as the limit value is the standard insulating voltage for the signal lamps.

The permitted ambient temperatures are always specified in conjunction with the maximum power of the lamps used, and the signal lamp should be located outside of the space subject to increased temperature.

To avoid this, a parallel resistor with  $1,2 \text{ M}\Omega \frac{1}{4} \text{ W}$ , can be used.

3

## Engraving and Hot Stamping

Custom-made legend inserts, photographic film inserts or customer-specific inserts. Standard font DIN 30 640, thin

type setting A or narrow-spaced semi-bold type E, however, with rounded ends of characters.

Type size* in mm	Line thickness in mm	Standard colour combinations	
		Lens colour	Legend
3	0,35	<b>transparent:</b>	
4	0,5	colourless and red	white
5	0,6	yellow, green, blue	white
6	0,7	<b>opaque:</b>	
8	0,8	black and dark grey	white
10	1	white, red, yellow, green	black
12,5	1,2	blue and light grey	black

\*The selected type size depends on text length and lens size.



## General Data

Signal lamps with integral LED, mounting hole diameter from 5 to 10 mm.  
The mm specification in the product name indicates the appropriate mounting hole diameter of the signal lamps.

## Content

<b>Signal lamps with integrated LED - 5 mm</b>	<b>3 - 4</b>	
Signal lamps with integrated LED - 5 mm, protruding LED	3 - 5	
Signal lamps with integrated LED - 5 mm, round protruding lens	3 - 5	
Signal lamps with integrated LED - 5 mm, round flush lens	3 - 6	
Signal lamps with integrated LED - 5 mm, triangular flush lens	3 - 7	
<b>Signal lamps with integrated LED - 7.0 mm</b>	<b>3 - 8</b>	
Signal lamps with integrated LED - 7.0 mm, round protruding lens	3 - 8	
<b>Signal lamps with integrated LED - 9.1 mm</b>	<b>3 - 10</b>	
Signal lamps with integrated LED - 9.1 mm, round lens	3 - 11	
Signal lamps with integrated LED - 9.1 mm, round protruding lens	3 - 11	
<b>Signal lamps with integrated LED - 10 mm</b>	<b>3 - 12</b>	
Signal lamps with integrated LED - 10 mm, protruding LED	3 - 13	
Signal lamps with integrated LED - 10 mm, round lens	3 - 14	
<b>RF 15 - Signal indicator</b>	<b>3 - 16</b>	
RF 15 - Signal indicator, fully illuminated, 1 LED	3 - 17	
<b>RF 19 - Signal indicator</b>	<b>3 - 18</b>	
RF 19 - Signal indicator, 1/2 x 1-module	3 - 19	
RF 19 - Signal indicator, 1/2 x 2-module	3 - 19	
RF 19 - Signal indicator, 1 x 1-module	3 - 20	
RF 19 - Signal indicator, 1 x 2-module	3 - 20	
<b>RG 85 III - Signal indicator, without lens</b>	<b>3 - 22</b>	
RG 85 III - Signal indicator, without lens	3 - 23	

## Signal lamps with integrated LED - 5 mm



Pict.: red

red

Mounting hole

### Technical Data

#### General information

Form of lens	see order block
Colour of lens	see order block
Diameter of collar	see order block

#### Dimensions

Length of collar	see order block
Overall height	see order block
Mounting depth	see order block
Mounting hole	5 mm

#### Mechanical design

Mounting	pressing into hole
Terminals	solder terminals
Lamp socket	no
Lamp	see order block

#### Electrical characteristics

Operating voltage $U_B$	see order block
Integrated current resistor	see order block
Forward voltage $U_F$ at 25 °C	at 10 mA forward current 2.2 V
Reverse voltage $U_R$ at 25 °C	3 V
Forward current, $I_F$ at 25 °C	see order block
Reverse current $I_R$ at 25 °C	100 $\mu$ A
Power dissipation $P_{tot}$ at 25 °C	max. 120 mW

#### Other specifications

Degree of protection from front side	IP40
Weight	0.35 g

**Operating voltage  $U_B$ :** DC voltage from 5 to 28V

A suitable series resistor is installed in the unit; versions without series resistor must be fitted with an external one.

External resistor:  $R_v = (U_B - U_F) : I_F$

Recommended ratings of external resistors:

- for 5 - 7 V = 330  $\Omega$  0.25 W
- for 12 - 16 V = 1.1 k $\Omega$  0.25 W
- for 24 - 28 V = 2.4 k $\Omega$  0.5 W

## Signal lamps with integrated LED - 5 mm, protruding LED

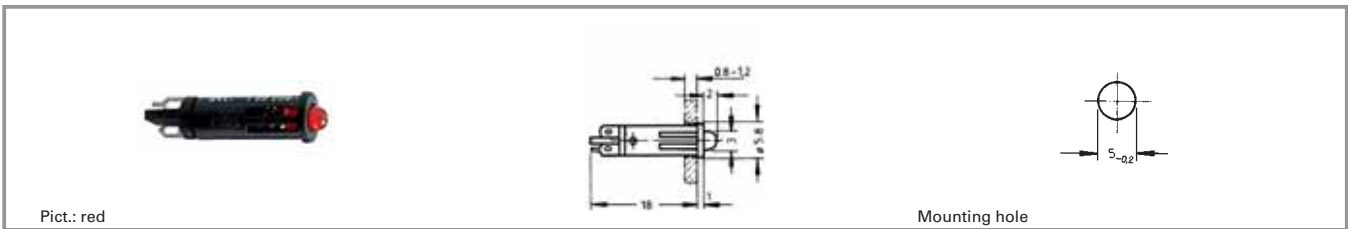

Integrated currency resistor	Operating voltage $U_B$	Forward current, $I_F$ at 25 °C	Lamp	Colour of lens	Order no.
yes	24 - 28 V	8 - 12 mA	LED red	transparent red	1.69.508.804/0000
yes	24 - 28 V	8 - 12 mA	LED green	transparent green	1.69.508.810/0000
yes	24 - 28 V	8 - 12 mA	LED yellow	transparent yellow	1.69.508.816/0000

Technical data see page 3 - 4

Long terminal is anode.

## Signal lamps with integrated LED - 5 mm, round protruding lens

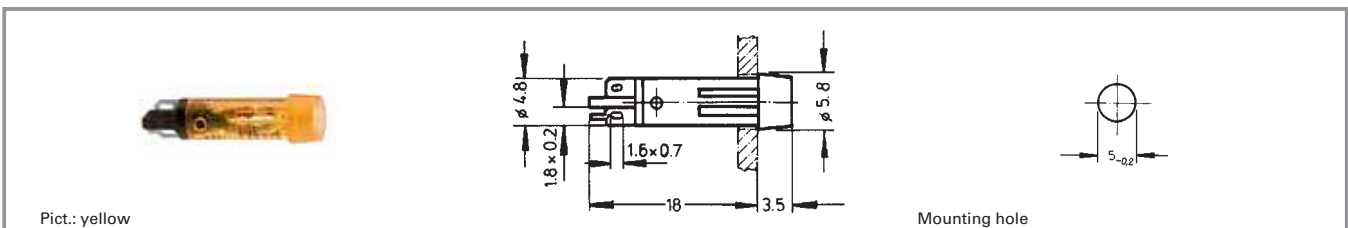

Integrated currency resistor	Operating voltage $U_B$	Forward current, $I_F$ at 25 °C	Lamp	Colour of lens	Order no.
no	according to series resistor 5 - 28 V	max. 20 mA	LED green	transparent green	1.69.508.837/1503
no	according to series resistor 5 - 28 V	max. 20 mA	LED yellow	transparent yellow	1.69.508.843/1402
yes	24 - 28 V	8 - 12 mA	LED red	transparent red	1.69.508.834/1301
yes	24 - 28 V	8 - 12 mA	LED green	transparent green	1.69.508.840/1503
yes	24 - 28 V	8 - 12 mA	LED yellow	transparent yellow	1.69.508.846/1402
yes	24 - 28 V	8 - 12 mA	LED super bright red	transparent red	1.69.508.835/1300
yes	24 - 28 V	8 - 12 mA	LED super bright yellow	transparent yellow	1.69.508.847/1400

Technical data see page 3 - 4

Long terminal is anode.

## Signal lamps with integrated LED - 5 mm, round flush lens

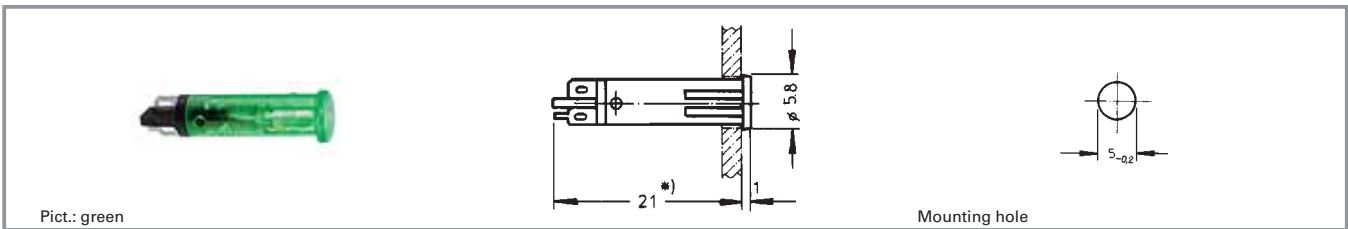

Integrated curren- cy resistor	Operating voltage $U_B$	Forward current, $I_F$ at 25 °C	Lamp	Colour of lens	Order no.
no	according to series resistor 5 - 28 V	max. 20 mA	LED red	transparent red	1.69.508.861/1301
no	according to series resistor 5 - 28 V	max. 20 mA	LED green	transparent green	1.69.508.867/1503
no	according to series resistor 5 - 28 V	max. 20 mA	LED yellow	transparent yellow	1.69.508.873/1402
yes	24 - 28 V	8 - 12 mA	LED red	transparent red	1.69.508.864/1301
yes	24 - 28 V	8 - 12 mA	LED green	transparent green	1.69.508.870/1503
yes	24 - 28 V	8 - 12 mA	LED yellow	transparent yellow	1.69.508.876/1402
yes	24 - 28 V	8 - 12 mA	LED super bright red	transparent red	1.69.508.865/1300
yes	24 - 28 V	8 - 12 mA	LED super bright yellow	transparent yellow	1.69.508.877/1400

Technical data see page 3 - 4

Long terminal is anode.

\* Without series resistor, mounting depth = 18 mm

3

integr.  
LED

## Signal lamps with integrated LED - 5 mm, triangular flush lens

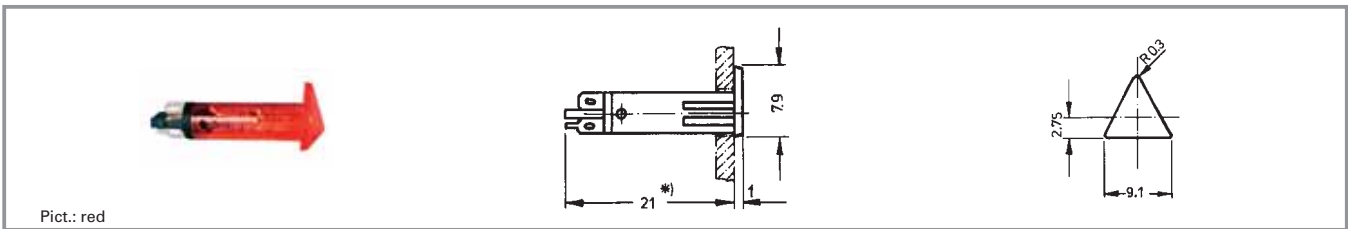

Pict.: red

Integrated currenry resistor	Operating voltage $U_B$	Forward current, $I_F$ at 25 °C	Lamp	Colour of lens	Order no.
yes	24 - 28 V	8 - 12 mA	LED red	transparent red	1.69.508.934/1301
yes	24 - 28 V	8 - 12 mA	LED green	transparent green	1.69.508.940/1503
yes	24 - 28 V	8 - 12 mA	LED yellow	transparent yellow	1.69.508.946/1402
yes	24 - 28 V	8 - 12 mA	LED super bright red	transparent red	1.69.508.935/1300
yes	24 - 28 V	8 - 12 mA	LED super bright yellow	transparent yellow	1.69.508.947/1400

Technical data see page 3 - 4

Long terminal is anode.

\* Without series resistor, mounting depth = 18 mm

## Signal lamps with integrated LED - 7.0 mm



### Technical Data

#### General information

Form of lens	round protruding
Colour of lens	see order block
Diameter of collar	8.5 mm

#### Dimensions

Overall height	5 mm
Mounting depth	27.5 mm
Mounting hole	7.0 mm

#### Mechanical design

Mounting	pressing into hole
Terminals	solder terminals
Lamp socket	no
Lamp	see order block

#### Electrical characteristics

Operating voltage $U_B$	24 - 28 V
Forward voltage $U_F$ at 25 °C	at 20 mA forward current 2.4 V
Reverse current $I_R$ at 25 °C	3 V
Forward current, $I_F$	max. 20 mA
Reverse current $I_R$ at 25 °C	100 $\mu$ A
Power dissipation $P_{tot}$ at 25 °C	max. 120 mW
Light intensity	see order block

#### Other specifications

Degree of protection from front side	IP40
--------------------------------------	------

3

integr.  
LED

## Signal lamps with integrated LED - 7.0 mm, round protruding lens

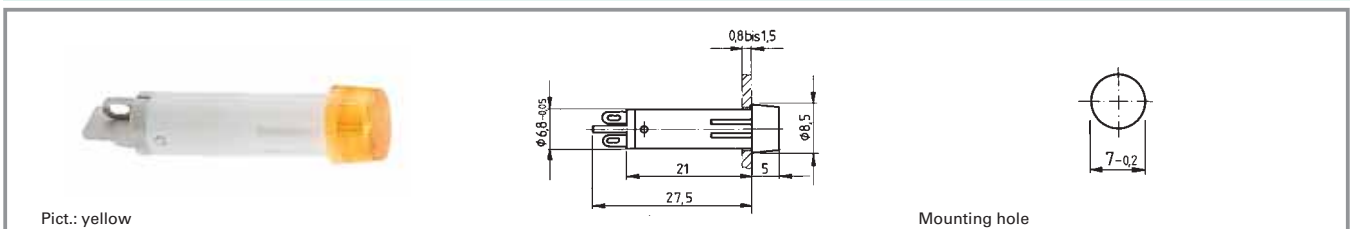

Operating voltage $U_B$	Forward current, $I_F$	Lamp	Colour of lens	Light intensity	Order no.
24 - 28 V	max. 20 mA	LED white	transparent colourless	400 mcd	1.69.511.101/1000
24 - 28 V	max. 20 mA	LED red	transparent red	200 mcd	1.69.511.102/1300
24 - 28 V	max. 20 mA	LED yellow	transparent yellow	200 mcd	1.69.511.103/1400
24 - 28 V	max. 20 mA	LED green	transparent green	1000 mcd	1.69.511.104/1500
24 - 28 V	max. 20 mA	LED blue	transparent blue	300 mcd	1.69.511.105/1600

Technical data see page 3 - 8





## Signal lamps with integrated LED - 9.1 mm



### Technical Data

#### General information

Form of lens	round protruding
Colour of lens	see order block
Diameter of collar	11 mm

#### Dimensions

Overall height	see order block
Mounting depth	30.5 mm
Mounting hole	9.1 mm

#### Mechanical design

Mounting	ring nut
Terminals	solder terminals
Lamp socket	no
Lamp	see order block

#### Electrical characteristics

Operating voltage $U_B$	24 - 28 V
Forward voltage $U_F$ at 25 °C	at 20 mA forward current 2.4 V
Reverse voltage $U_R$ at 25 °C	3 V
Reverse current $I_R$ at 25 °C	100 $\mu$ A
Power dissipation $P_{tot}$ at 25 °C	max. 120 mW
Light intensity at 20 mA	see order block

#### Other specifications

Degree of protection from front side	IP40
Weight	1 g

3

integr.  
LED

### Typical accessories Signal lamps with integrated LED - 9.1 mm

Description	Photo	Order no.	Additional accessories see page
Fixing spanner M 9, M 10		<b>5.58.002.025/0105</b>	5 - 21

## Signal lamps with integrated LED - 9.1 mm, round lens

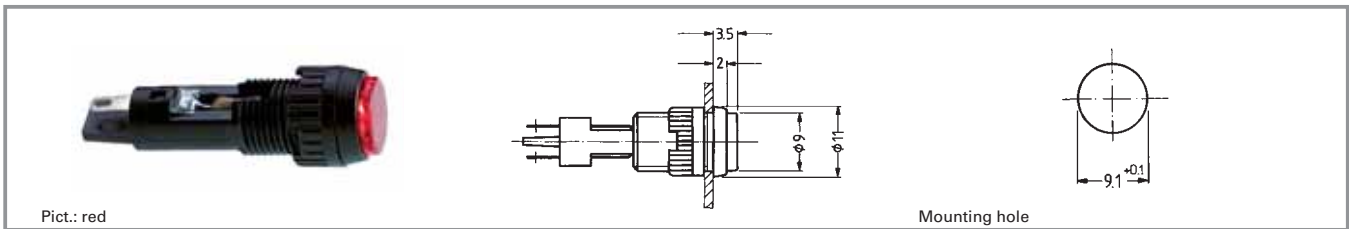

Operating voltage U <sub>B</sub>	Light intensity at 20 mA	Lamp	Colour of lens	Order no.
24 - 28 V	200 mcd	LED super bright red	transparent red	1.02.157.105/1300
24 - 28 V	1000 mcd	LED super bright green	transparent green	1.02.157.110/1500
24 - 28 V	200 mcd	LED super bright yellow	transparent yellow	1.02.157.115/1400
24 - 28 V	300 mcd	LED super bright blue	transparent blue	1.02.157.120/1600
24 - 28 V	400 mcd	LED super bright white	transparent colourless	1.02.157.125/1000

Technical data see page 3 - 10

**Accessoires:**

Fixing spanner M 9, M 10: **5.58.002.025/0105**

With integrated series resistor. Other voltages on request.

3

## Signal lamps with integrated LED - 9.1 mm, round protruding lens

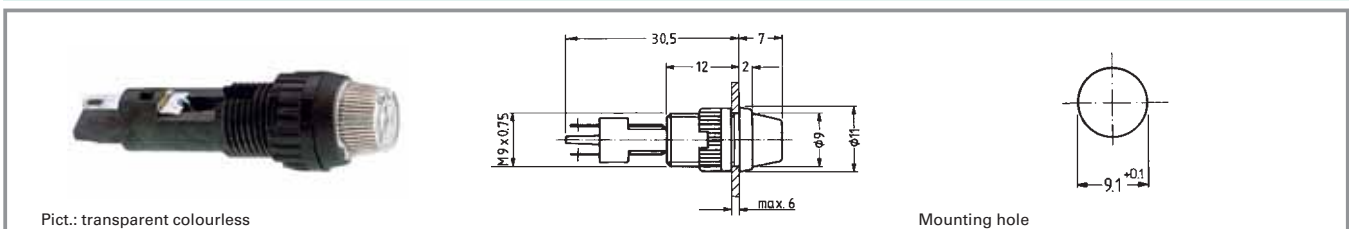

Operating voltage U <sub>B</sub>	Light intensity at 20 mA	Lamp	Colour of lens	Order no.
24 - 28 V	200 mcd	LED super bright red	transparent red	1.02.157.505/1300
24 - 28 V	1000 mcd	LED super bright green	transparent green	1.02.157.510/1500
24 - 28 V	200 mcd	LED super bright yellow	transparent yellow	1.02.157.515/1400
24 - 28 V	300 mcd	LED super bright blue	transparent blue	1.02.157.520/1600
24 - 28 V	400 mcd	LED super bright white	transparent colourless	1.02.157.525/1000

Technical data see page 3 - 10

**Accessoires:**

Fixing spanner M 9, M 10: **5.58.002.025/0105**

With integrated series resistor. Other voltages on request.

integr.  
LED

## Signal lamps with integrated LED - 10 mm



### Technical Data

#### General information

Form of lens	see order block
Colour of lens	see order block
Diameter of collar	12.5 mm

#### Dimensions

Overall height	see order block
Mounting depth	30.5 mm
Mounting hole	10 mm

#### Mechanical design

Mounting	pressing into hole
Terminals	quick connector 2.8 x 0.8 mm
Lamp socket	no
Lamp	see order block

#### Electrical characteristics

Operating voltage $U_B$	see order block
Integrated currency resistor	see order block
Forward voltage $U_F$ at 25 °C	at 20 mA forward current 2.4 V
Reverse voltage $U_R$ at 25 °C	3 V
Forward current, $I_F$	see order block
Reverse current $I_R$ at 25 °C	100 $\mu$ A
Power dissipation $P_{tot}$ at 25 °C	max. 120 mW
Light intensity	see order block
Protecting diode	see order block

#### Other specifications

Degree of protection from front side	IP40
Weight	2.44 g

**Operating voltage  $U_B$**  DC voltage from 6 - 28 V

A suitable series resistor is installed in the unit; the version without resistor must be fitted with an external one. A version with an additional protective diode is available to protect the LED against any voltage peaks.

External resistor:  $R_V = (U_B - U_F) : I_F$

Recommended ratings of external resistors:

- for 6 - 7 V = 330  $\Omega$  0.25 W
- for 12 - 16 V = 680  $\Omega$  0.5 W
- for 24 - 28 V = 1500  $\Omega$  1 W

## Signal lamps with integrated LED - 10 mm, protruding LED

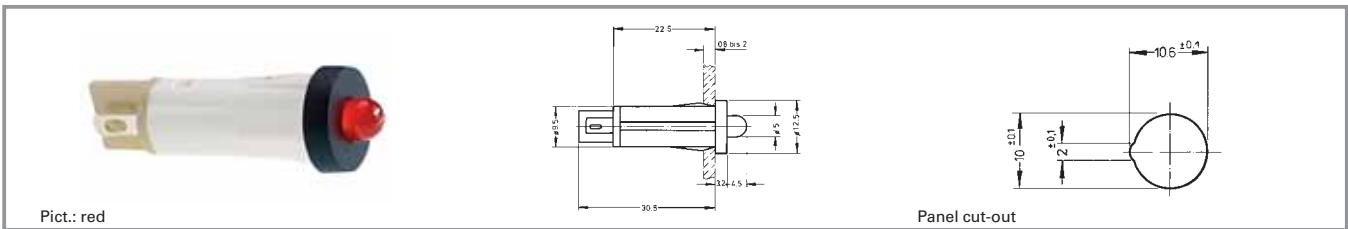

Integrated currenxy resistor	Protecting diode	Operating voltage $U_B$	Forward current, $I_F$	Colour of lens	Light intensity	Order no.
no	yes	according to series resistor 6 - 28 V	max. 20 mA	red	1000 mcd	1.69.525.051/0000
no	yes	according to series resistor 6 - 28 V	max. 20 mA	green	1000 mcd	1.69.525.056/0000
no	yes	according to series resistor 6 - 28 V	max. 20 mA	yellow	200 mcd	1.69.525.061/0000
no	no	according to series resistor 6 - 28 V	max. 20 mA	red	200 mcd	1.69.525.001/0000
no	no	according to series resistor 6 - 28 V	max. 20 mA	green	1000 mcd	1.69.525.006/0000
no	no	according to series resistor 6 - 28 V	max. 20 mA	yellow	200 mcd	1.69.525.011/0000
yes	yes	24 - 28 V	15 - 20 mA	red	200 mcd	1.69.525.054/0000
yes	yes	24 - 28 V	13 - 18.5 mA	green	1000 mcd	1.69.525.059/0000
yes	yes	24 - 28 V	13 - 18.5 mA	yellow	200 mcd	1.69.525.064/0000
yes	no	24 - 28 V	15 - 20 mA	red	200 mcd	1.69.525.004/0000
yes	no	24 - 28 V	13 - 18.5 mA	green	1000 mcd	1.69.525.009/0000
yes	no	24 - 28 V	13 - 18.5 mA	yellow	200 mcd	1.69.525.014/0000

Technical data see page 3 - 12

3

integr.  
LED

## Signal lamps with integrated LED - 10 mm, round lens

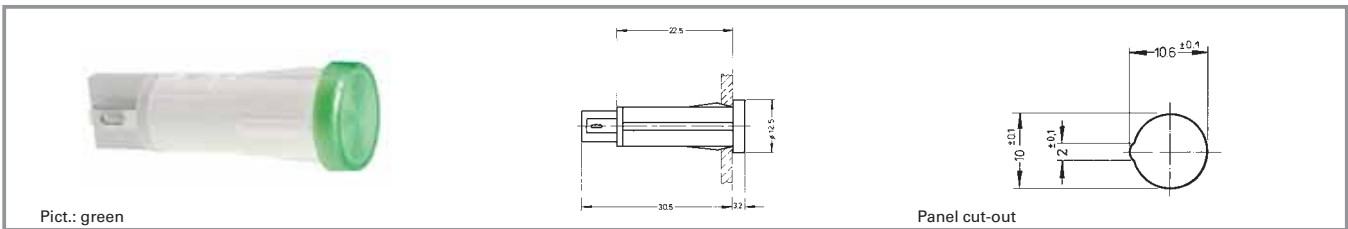

Integrated curren- cy resistor	Protecting diode	Operating voltage $U_B$	Forward current, $I_F$	Colour of lens	Light intensity	Order no.
yes	yes	24 - 28 V	15 - 20 mA	red	200 mcd	1.69.525.255/1300
yes	yes	24 - 28 V	13 - 18.5 mA	green	1000 mcd	1.69.525.260/1500
yes	yes	24 - 28 V	13 - 18.5 mA	yellow	200 mcd	1.69.525.265/1400
yes	yes	24 - 28 V	-	blue	300 mcd	1.69.525.266/1600
yes	yes	24 - 28 V	-	white	400 mcd	1.69.525.271/1000
yes	no	24 - 28 V	15 - 20 mA	red	200 mcd	1.69.525.205/1300
yes	no	24 - 28 V	13 - 18.5 mA	green	1000 mcd	1.69.525.210/1500
yes	no	24 - 28 V	13 - 18.5 mA	yellow	200 mcd	1.69.525.215/1400
yes	no	24 - 28 V	-	blue	300 mcd	1.69.525.216/1600
yes	no	24 - 28 V	-	white	400 mcd	1.69.525.221/1000

Technical data see page 3 - 12

Other voltages on request.

3

integr.  
LED



## RF 15 - Signal indicator



Pict.: green

### Technical Data

#### General information

Colour of lens	see order block
Recommended key grid	19.05 mm

#### Dimensions

Length	15 mm
Width	15 mm
Overall height	9.7 mm

#### Mechanical design

Mounting	THT soldering in PCB
Illumination	fully illuminated 1 LED
LED colour	see order block
LED type	2 mm

#### Other specifications

Ambient temp. operating min.	-25 °C
Ambient temp. operating max.	+70 °C
Environmental resistance	acc. to IEC 60068-2 -14, -30, -33 and -78
Solderability / solder heat resistance	according to E DIN IEC 600 28-2-20
Wave soldering	260 °C max.
Manual soldering	350 °C / 5 sec. max.

3

integr.  
LED



## RF 15 - Signal indicator, fully illuminated, 1 LED



Pict.: green

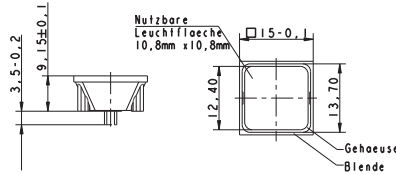

Overall height	Illumination	Colour of lens	LED colour	LED type	Order no.
9.7 mm	fully illuminated 1 LED	red	red	2 mm	<b>3.14.200.051/0000</b>
9.7 mm	fully illuminated 1 LED	green	green	2 mm	<b>3.14.200.052/0000</b>
9.7 mm	fully illuminated 1 LED	yellow	yellow	2 mm	<b>3.14.200.053/0000</b>
9.7 mm	fully illuminated 1 LED	orange	yellow	2 mm	3.14.200.054/0000
9.7 mm	fully illuminated 1 LED	blue	blue	2 mm	3.14.200.055/0000

Technical data see page 3 - 16

Technical data of LED see separate page at the beginning of chapter 4 PCB Keyswitches.

## RF 19 - Signal indicator

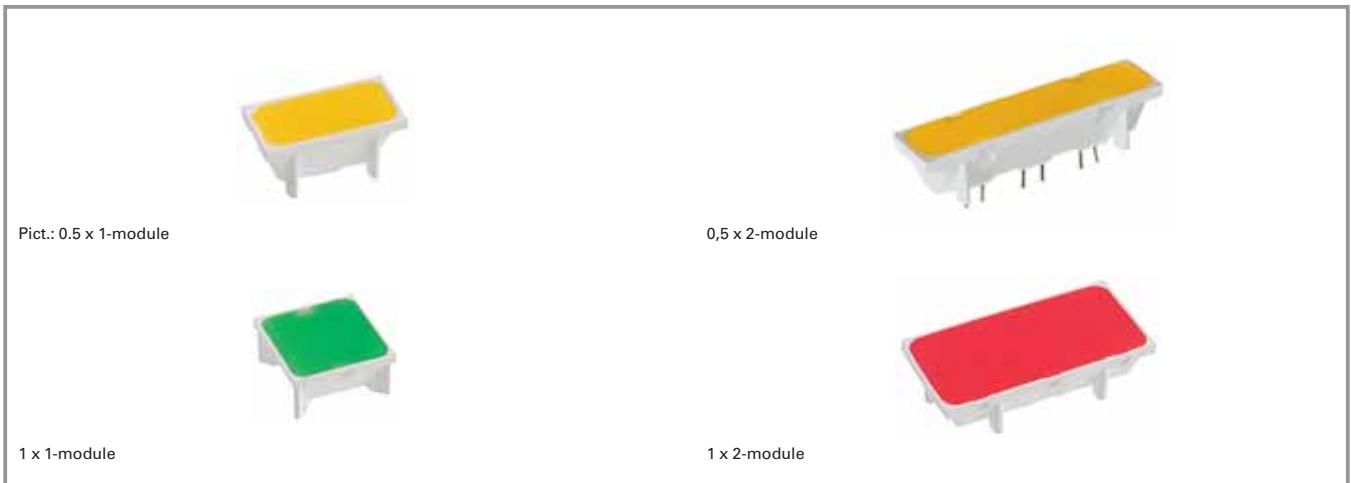

### Technical Data

#### General information

Colour of lens see order block  
Recommended key grid 23/x mm

#### Dimensions

Length see order block  
Width see order block  
Overall height 9.15 mm

#### Mechanical design

Mounting THT soldering in PCB  
Illumination see order block  
LED colour see order block  
LED type see order block

#### Other specifications

Ambient temp. operating min. -25 °C  
Ambient temp. operating max. +70 °C  
Environmental resistance acc. to IEC 60068-2 -14, -30, -33 and -78 according to E DIN IEC 600 28-2-20  
Solderability / solder heat resistance  
Wave soldering 260 °C max.  
Manual soldering 350 °C / 5 sec. max.

3

integr.  
LED

## RF 19 - Signal indicator, 1/2 x 1-module

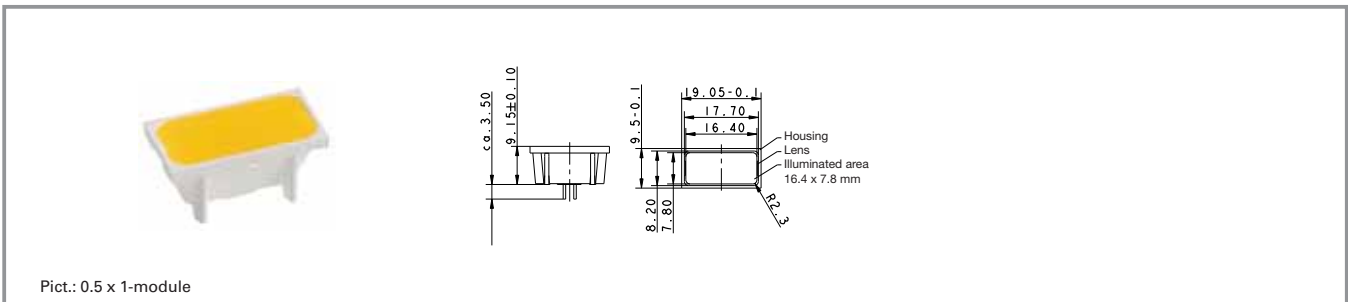

Pict.: 0.5 x 1-module

illumination	Colour of lens	LED colour	LED type	Order no.
fully illuminated 1 LED	red	red	2 mm	<b>3.14.002.061/0000</b>
fully illuminated 1 LED	green	green	2 mm	3.14.002.062/0000
fully illuminated 1 LED	yellow	yellow	2 mm	3.14.002.063/0000
fully illuminated 1 LED	orange	yellow	2 mm	3.14.002.064/0000

Technical data see page 3 - 18

Technical data of LED see separate page at the beginning of chapter 4 PCB Keyswitches.

3

## RF 19 - Signal indicator, 1/2 x 2-module

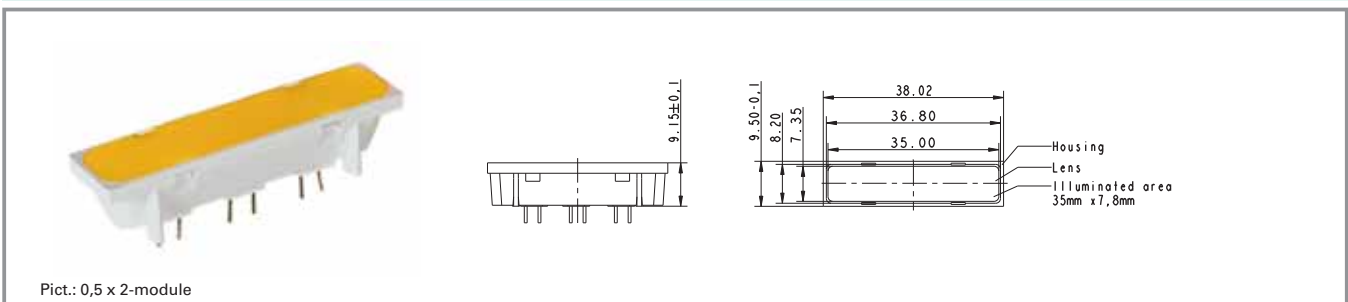

Pict.: 0,5 x 2-module

illumination	Colour of lens	LED colour	LED type	Order no.
fully illuminated 3 LED	red	red	2 mm	3.14.002.908/0000
fully illuminated 3 LED	green	green	2 mm	3.14.002.909/0000
fully illuminated 3 LED	yellow	yellow	2 mm	3.14.002.910/0000
fully illuminated 3 LED	orange	yellow	2 mm	3.14.002.911/0000

Technical data see page 3 - 18

Technical data of LED see separate page at the beginning of chapter 4 PCB Keyswitches.

integr.  
LED

## RF 19 - Signal indicator, 1 x 1-module

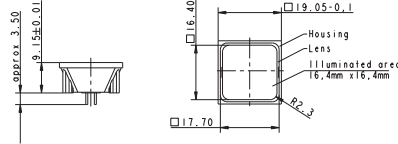

Pict.: 1 x 1-module

illumination	Colour of lens	LED colour	LED type	Order no.
fully illuminated 2 LED	red	red	2 mm	<b>3.14.002.051/0000</b>
fully illuminated 2 LED	green	green	2 mm	<b>3.14.002.052/0000</b>
fully illuminated 2 LED	yellow	yellow	2 mm	<b>3.14.002.053/0000</b>
fully illuminated 2 LED	orange	yellow	2 mm	3.14.002.054/0000
fully illuminated 2 LED	blue	blue	2 mm	3.14.001.659/0000

Technical data see page 3 - 18

For technical data of the LED see separate page at the beginning of chapter „RF short-travel keyswitches“

Suitable for RK 90 system design, illuminated for 2-module keycap.

3

integr.  
LED

## RF 19 - Signal indicator, 1 x 2-module

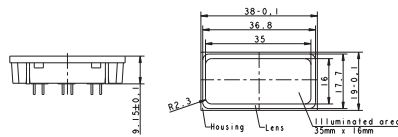

Pict.: 1 x 2-module

illumination	Colour of lens	LED colour	LED type	Order no.
fully illuminated 5 LED	red	red	2 mm	3.14.002.071/0000
fully illuminated 5 LED	green	green	2 mm	3.14.002.072/0000
fully illuminated 5 LED	yellow	yellow	2 mm	3.14.002.073/0000
fully illuminated 5 LED	orange	yellow	2 mm	3.14.002.074/0000

Technical data see page 3 - 18

For technical data of the LED see separate page at the beginning of chapter „RF short-travel keyswitches“



## RG 85 III - Signal indicator, without lens



### Technical Data

<b>Dimensions</b>		<b>Other specifications</b>	
Mounting grid min.	55 x 35 mm	Ambient temp. operating min.	-25 °C
Length	64 mm	Ambient temp. operating max.	+70 °C
Width	34 mm	Storage temperature min.	-40 °C
		Storage temperature max.	+80 °C
		Environmental resistance	acc. to IEC 60068-2 -14, -30, -33 and -78
<b>Mechanical design</b>		Degree of protection rail mounting	IP40
Version	according to lens on U-rails or single mounting	Degree of protection single mounting	IP65
Mounting		Flammability of materials	according to UL 94 HB
Terminals	8-pin Micro-Match® female connector		
Illumination	see order block		
<b>Electrical characteristics</b>			
Operating voltage for LED	24±20% V		
Input current LED	depending on LED colour 20 - 30 mA		

3  
integr.  
LED

### Typical accessories RG 85 III - Signal indicator, without lens

Description	Photo	Order no.	Additional accessories see page
Cable, 8 wires, with socket connectors on both ends, length 2 m		5.03.772.262/0000	4 - 122
RG 85 III - Lens, square, for signal indicators		5.04.903.009/0000	4 - 122
RG 85 III - Lens, round, for signal indicators		5.04.903.010/0000	4 - 121
RG 85 III - Lens, triangular, for signal indicators		<b>5.04.903.011/0000</b>	4 - 122

## RG 85 III - Signal indicator, without lens

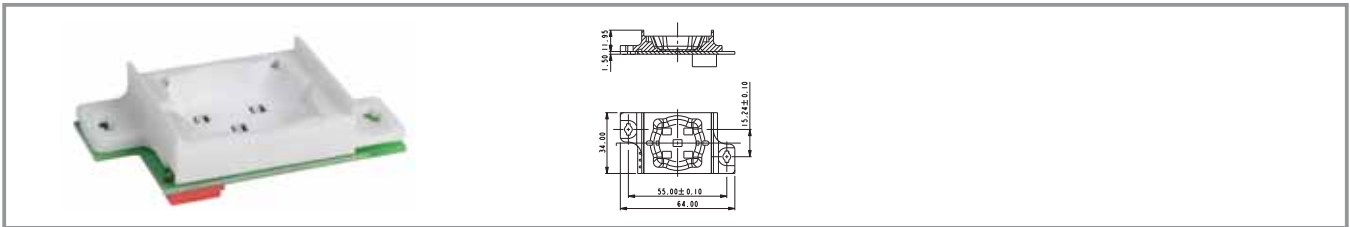

illumination	Order no.
5 LED white	3.99.400.100/2000
5 LED red	3.99.400.100/3000
5 LED yellow	3.99.400.100/4000
5 LED green	3.99.400.100/5000
5 LED blue	3.99.400.100/6000
5 LED white, 5 LED blue	3.99.400.100/7000
5 LED green, 5 LED red	3.99.400.100/8000

Technical data see page 3 - 22

Please order round, square or triangular lenses separately.







## General Data

Signal lamps with integral filament lamp, neon lamp or neon glow lamp.  
For mounting hole diameters from 5 to 14 mm. The mm specification in the product name indicates the appropriate mounting hole diameter of the signal lamps.

## Content

<b>Signal lamps with integrated filament lamp - 5 mm</b>	<b>3 - 26</b>
Signal lamps with integrated filament lamp - 5 mm, round lens	3 - 27
<b>Signal lamps with integrated filament/neon lamp - 7 mm</b>	<b>3 - 28</b>
Signal lamps with integrated filament/neon lamp - 7 mm, solder terminals	3 - 29
<b>Signal lamps with integrated filament/neon lamp - 10 mm</b>	<b>3 - 30</b>
Signal lamps with integrated filament/neon lamp - 10 mm, round lens	3 - 31
<b>Signal lamps with integrated filament/neon lamp - 10 mm</b>	<b>3 - 32</b>
Signal lamps with integrated filament/neon lamp - 10 mm, round lens	3 - 33
Signal lamps with integrated filament/neon lamp - 10 mm, square lens	3 - 34
Signal lamps with integrated filament/neon lamp - 10 mm, lens in arrow shape	3 - 35
<b>Signal lamps with integrated filament/neon lamp - 14 mm</b>	<b>3 - 36</b>
Signal lamps with integrated neon lamp - 14 mm, round lens, 230 V	3 - 37
Signal lamps with integrated filament lamp - 14 mm, round lens, 28 V	3 - 37

## Signal lamps with integrated filament lamp - 5 mm



Pict.: green

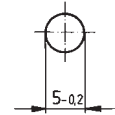

Mounting hole

### Technical Data

#### General information

Form of lens	see order block
Colour of lens	see order block
Diameter of collar	see order block

#### Dimensions

Length of collar	see order block
Width of collar	see order block
Overall height	1 mm
Mounting depth	18 mm
Mounting hole	5 mm

#### Mechanical design

Mounting	pressing into hole
Terminals	solder terminals
Lamp socket	no
Lamp	filament lamp

#### Electrical characteristics

Voltage limit max.	24 V
Power limit max.	0.45 W

#### Other specifications

Operating life	10,000 h
Degree of protection from front side	IP40
Weight	0.3 g

3

integr.  
Lamp

## Signal lamps with integrated filament lamp - 5 mm, round lens

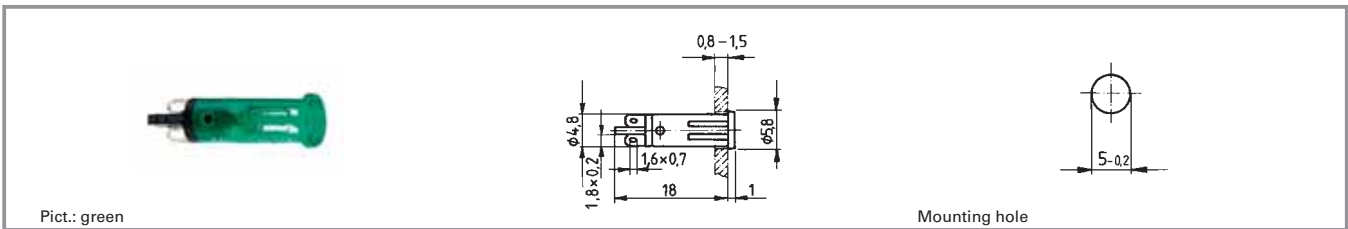

Voltage limit max.	Power limit max.	Lamp	Operating life	Colour of lens	Order no.
24 V	0.45 W	filament lamp	10000 h	transparent colourless	1.69.508.113/1002
24 V	0.45 W	filament lamp	10000 h	transparent red	1.69.508.113/1301
24 V	0.45 W	filament lamp	10000 h	transparent yellow	1.69.508.113/1402
24 V	0.45 W	filament lamp	10000 h	transparent green	1.69.508.113/1502
24 V	0.45 W	filament lamp	10000 h	transparent blue	1.69.508.113/1601

Technical data see page 3 - 26

## Signal lamps with integrated filament/neon lamp - 7 mm



### Technical Data

#### General information

Form of lens	round
Colour of lens	see order block
Diameter of collar	8.5

#### Dimensions

Overall height	5 mm
Mounting depth	see order block
Mounting hole	7 mm

#### Mechanical design

Mounting	pressing into hole
Terminals	see order block
Lamp socket	no
Lamp	see order block

#### Electrical characteristics

Voltage limit max.	see order block
Power limit max.	see order block

#### Other specifications

Operating life	see order block
Degree of protection from front side	IP40
Weight	0.87 g

3

integr.  
Lamp

### Approvals



VDE T85° (only version with neon lamp)

## Signal lamps with integrated filament/neon lamp - 7 mm, solder terminals

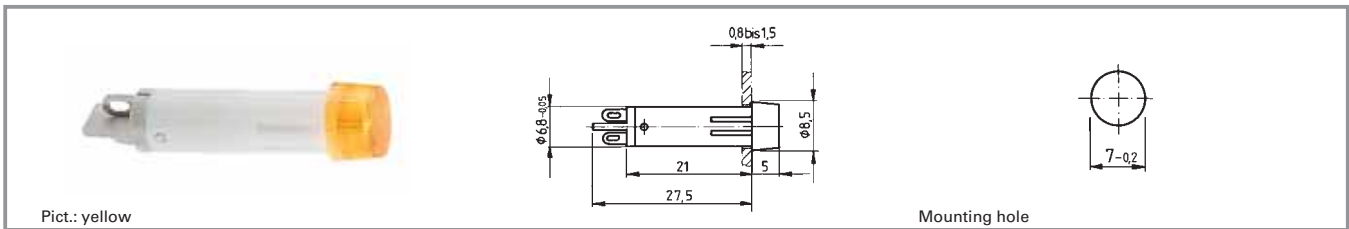

Voltage limit max.	Power limit max.	Terminals	Lamp	Operating life	Colour of lens	Order no.
24 V	0.84 W	solder terminals	filament lamp	25,000 h	transparent colourless	1.69.511.054/1002
24 V	0.84 W	solder terminals	filament lamp	25,000 h	transparent red	1.69.511.054/1301
24 V	0.84 W	solder terminals	filament lamp	25,000 h	transparent yellow	1.69.511.054/1402
24 V	0.84 W	solder terminals	filament lamp	25,000 h	transparent green	1.69.511.054/1502
230 V	-	solder terminals	neon lamp	-	transparent colourless	1.69.511.059/1002
230 V	-	solder terminals	neon lamp	-	transparent red	1.69.511.059/1301
230 V	-	solder terminals	neon lamp	-	transparent yellow	1.69.511.059/1402

Technical data see page 3 - 28

Other voltages on request.

## Signal lamps with integrated filament/neon lamp - 10 mm

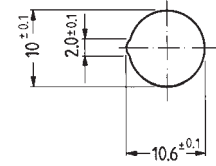

Panel cut-out

### Technical Data

#### General information

Form of lens	see order block
Colour of lens	see order block
Diameter of collar	see order block

#### Dimensions

Length of collar	see order block
Width of collar	see order block
Overall height	1.2 mm
Mounting depth	32 mm
Mounting hole	10 mm

#### Mechanical design

Mounting	pressing into hole
Terminals	quick connector 2.8 x 0.8 mm
Lamp socket	no
Lamp	see order block

#### Electrical characteristics

Voltage limit max.	see order block
Power limit max.	see order block

#### Other specifications

Operating life	see order block
Degree of protection from front side	IP40
Weight	2.5 g

3

integr.  
Lamp

#### Approvals



VDE T85° (only version with neon lamp)

## Signal lamps with integrated filament/neon lamp - 10 mm, round lens

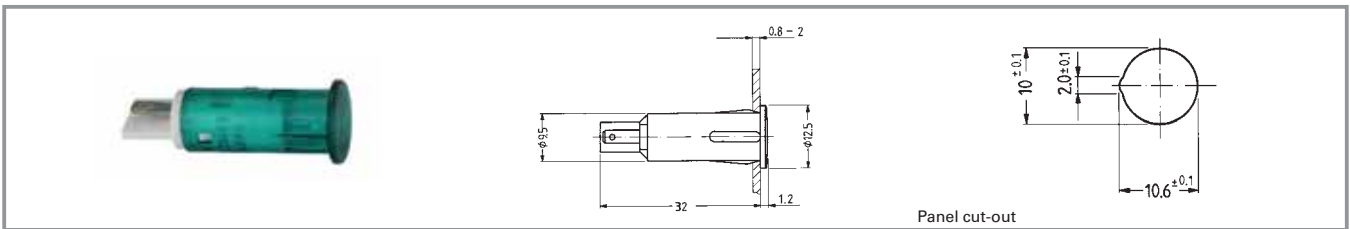

Voltage limit max.	Power limit max.	Lamp	Operating life	Colour of lens	Order no.
28 V	1.2 W	filament lamp	10,000 h	transparent colourless	1.69.527.003/1002
28 V	1.2 W	filament lamp	10,000 h	transparent red	1.69.527.003/1301
28 V	1.2 W	filament lamp	10,000 h	transparent yellow	1.69.527.003/1402
28 V	1.2 W	filament lamp	10,000 h	transparent green	1.69.527.003/1502
230 V	-	neon lamp	-	transparent colourless	1.69.527.104/1002
230 V	-	neon lamp	-	transparent red	1.69.527.104/1301
230 V	- W	neon lamp	-	transparent yellow	1.69.527.104/1402

Technical data see page 3 - 30

3

integr.  
Lamp

## Signal lamps with integrated filament/neon lamp - 10 mm

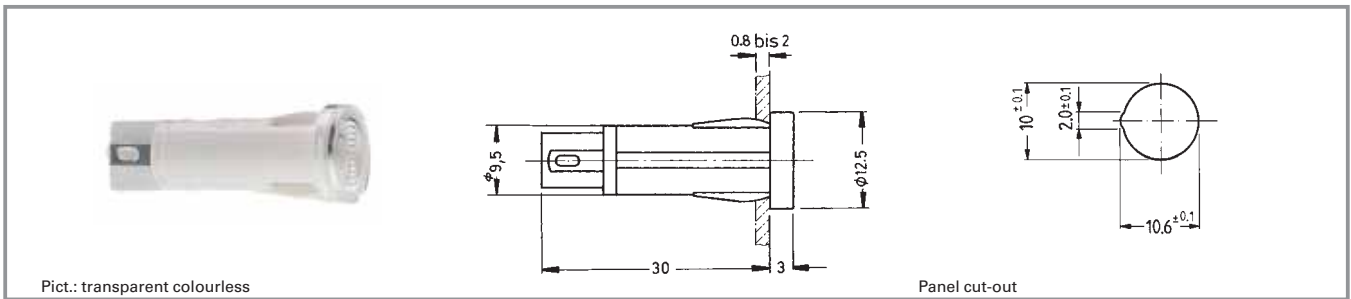

### Technical Data

#### General information

Form of lens	see order block
Colour of lens	see order block
Diameter of collar	see order block

#### Dimensions

Length of collar	see order block
Width of collar	see order block
Overall height	3 mm
Mounting depth	30 mm
Mounting hole	10 mm

#### Mechanical design

Mounting	pressing into hole
Terminals	see order block
Lamp socket	no
Lamp	see order block

#### Electrical characteristics

Voltage limit max.	see order block
Power limit max.	see order block

#### Other specifications

Operating life	see order block
Degree of protection from front side	IP40
Weight	2.5 g

3

integr.  
Lamp

#### Approvals



VDE 0710  
(T85° for filament  
and T120° for neon  
lamp versions)



## Signal lamps with integrated filament/neon lamp - 10 mm, round lens

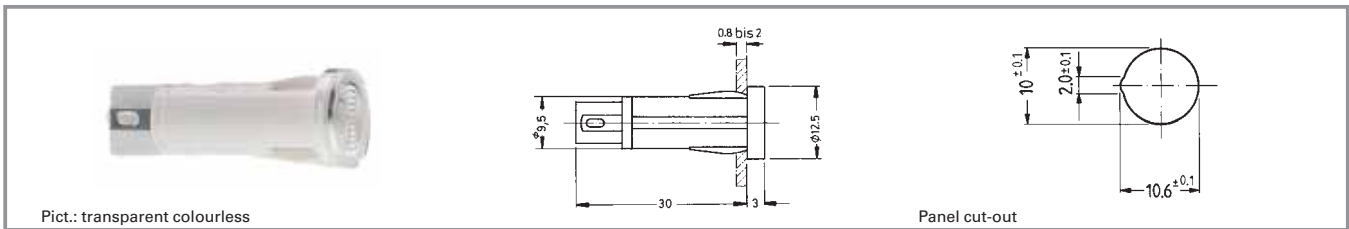

Voltage limit max.	Power limit max.	Lamp	Terminals	Operating life	Colour of lens	Order no.
28 V	1.2 W	filament lamp	quick connector 2.8 x 0.8	10,000 h	opaque white	1.69.507.105/0214
28 V	1.2 W	filament lamp	quick connector 2.8 x 0.8	10,000 h	transparent colourless	1.69.507.105/1002
28 V	1.2 W	filament lamp	quick connector 2.8 x 0.8	10,000 h	transparent red	1.69.507.105/1301
28 V	1.2 W	filament lamp	quick connector 2.8 x 0.8	10,000 h	transparent yellow	1.69.507.105/1402
28 V	1.2 W	filament lamp	quick connector 2.8 x 0.8	10,000 h	transparent green	1.69.507.105/1502
28 V	1.2 W	filament lamp	quick connector 2.8 x 0.8	10,000 h	transparent blue	1.69.507.105/1601
230 V	-	neon lamp	quick connector 2.8 x 0.8	-	transparent colourless	1.69.507.117/1002
230 V	-	neon lamp	quick connector 2.8 x 0.8	-	transparent red	1.69.507.117/1301
230 V	-	neon lamp	quick connector 2.8 x 0.8	-	transparent yellow	1.69.507.117/1402
230 V	-	neon glow lamp	quick connector 2.8 x 0.8	-	transparent green	1.69.507.118/1502

Technical data see page 3 - 32

Other voltages and versions with connection cable on request.

## Signal lamps with integrated filament/neon lamp - 10 mm, square lens

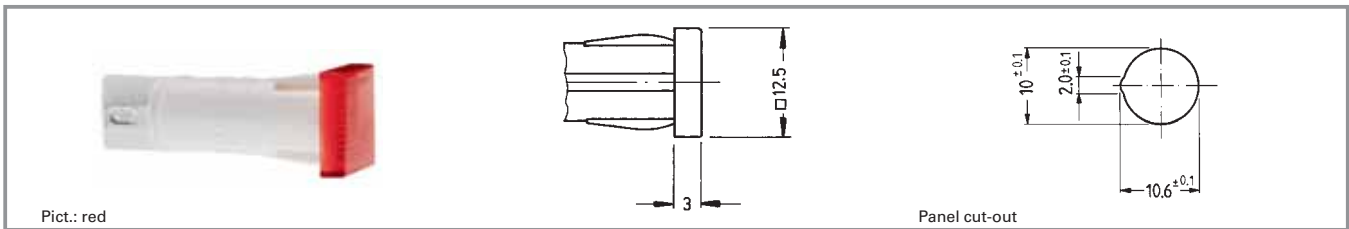

Voltage limit max.	Power limit max.	Lamp	Terminals	Operating life	Colour of lens	Order no.
28 V	1.2 W	filament lamp	quick connector 2.8 x 0.8	10,000 h	opaque white	1.69.507.125/0214
28 V	1.2 W	filament lamp	quick connector 2.8 x 0.8	10,000 h	transparent colourless	1.69.507.125/1002
28 V	1.2 W	filament lamp	quick connector 2.8 x 0.8	10,000 h	transparent red	1.69.507.125/1301
28 V	1.2 W	filament lamp	quick connector 2.8 x 0.8	10,000 h	transparent yellow	1.69.507.125/1402
28 V	1.2 W	filament lamp	quick connector 2.8 x 0.8	10,000 h	transparent green	1.69.507.125/1502
28 V	1.2 W	filament lamp	quick connector 2.8 x 0.8	10,000 h	transparent blue	1.69.507.125/1601
230 V	-	neon lamp	quick connector 2.8 x 0.8	-	transparent colourless	1.69.507.137/1002
230 V	-	neon lamp	quick connector 2.8 x 0.8	-	transparent red	1.69.507.137/1301
230 V	-	neon lamp	quick connector 2.8 x 0.8	-	transparent yellow	1.69.507.137/1402
230 V	-	neon glow lamp	quick connector 2.8 x 0.8	-	transparent green	1.69.507.138/1502

3

integr.  
Lamp

Technical data see page 3 - 32

Other voltages and versions with connection cable on request.

## Signal lamps with integrated filament/neon lamp - 10 mm, lens in arrow shape

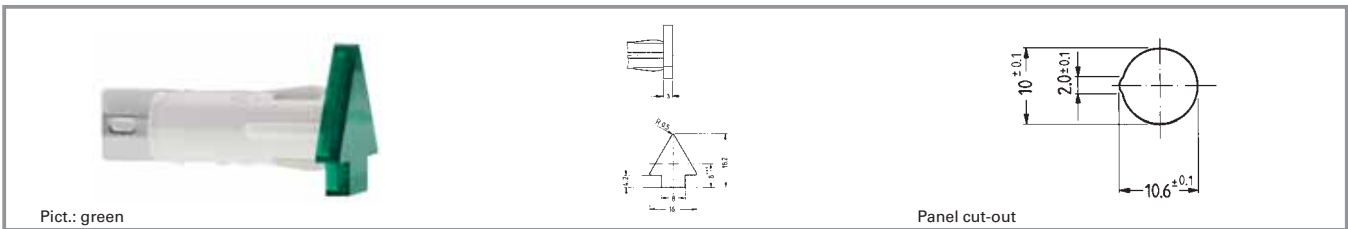

Voltage limit max.	Power limit max.	Lamp	Terminals	Operating life	Colour of lens	Order no.
28 V	1.2 W	filament lamp	quick connector 2.8 x 0.8	10,000 h	opaque white	1.69.507.145/0214
28 V	1.2 W	filament lamp	quick connector 2.8 x 0.8	10,000 h	transparent colourless	1.69.507.145/1002
28 V	1.2 W	filament lamp	quick connector 2.8 x 0.8	10,000 h	transparent red	1.69.507.145/1301
28 V	1.2 W	filament lamp	quick connector 2.8 x 0.8	10,000 h	transparent yellow	1.69.507.145/1402
28 V	1.2 W	filament lamp	quick connector 2.8 x 0.8	10,000 h	transparent green	1.69.507.145/1502
28 V	1.2 W	filament lamp	quick connector 2.8 x 0.8	10,000 h	transparent blue	1.69.507.145/1601
230 V	-	neon lamp	quick connector 2.8 x 0.8	-	transparent colourless	1.69.507.157/1002
230 V	-	neon lamp	quick connector 2.8 x 0.8	-	transparent red	1.69.507.157/1301
230 V	-	neon lamp	quick connector 2.8 x 0.8	-	transparent yellow	1.69.507.157/1402
230 V	-	neon glow lamp	quick connector 2.8 x 0.8	-	transparent green	1.69.507.158/1502

Technical data see page 3 - 32

Other voltages and versions with connection cable on request.

3

integr.  
Lamp

## Signal lamps with integrated filament/neon lamp - 14 mm



### Technical Data

#### General information

Form of lens see order block  
Colour of lens see order block

#### Dimensions

Dimensions of collar see order block  
Overall height 4 mm  
Mounting depth see order block  
Mounting hole 14 mm

#### Mechanical design

Mounting pressing into hole  
Terminals see order block  
Lamp socket no  
Lamp see order block

#### Electrical characteristics

Voltage limit max. see order block  
Power limit max. 1.2 W

#### Other specifications

Operating life see order block  
Degree of protection from front side IP40  
Weight 5 g

3

integr.  
Lamp

#### Approvals



VDET85° (only version with neon lamp)

## Signal lamps with integrated neon lamp - 14 mm, round lens, 230 V

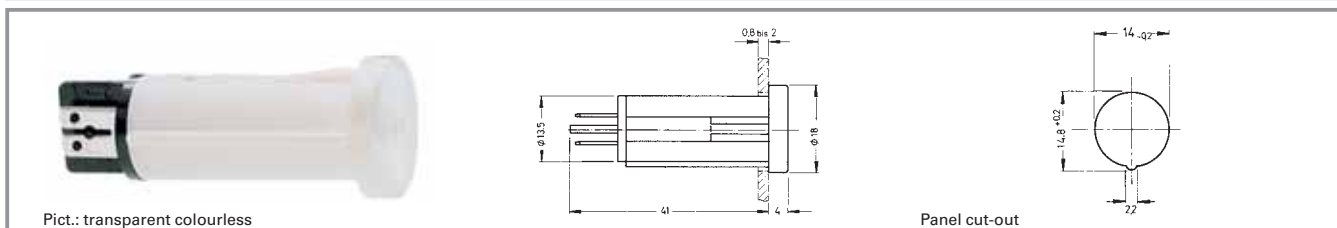

Voltage limit max.	Power limit max.	Lamp	Terminals	Operating life	Colour of lens	Order no.
230 V	-	neon lamp	quick connector 2.8 x 0.8	-	transparent colourless	1.02.614.502/1002
230 V	-	neon lamp	quick connector 2.8 x 0.8	-	transparent red	1.02.614.502/1301
230 V	-	neon lamp	quick connector 2.8 x 0.8	-	transparent yellow	1.02.614.502/1402
230 V	-	neon glow lamp	quick connector 2.8 x 0.8	-	transparent green	1.02.614.503/1502

Technical data see page 3 - 36

## Signal lamps with integrated filament lamp - 14 mm, round lens, 28 V

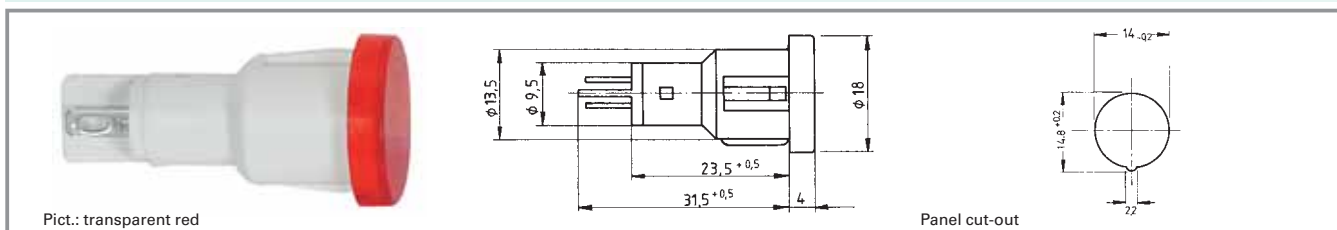

Voltage limit max.	Power limit max.	Lamp	Terminals	Operating life	Colour of lens	Order no.
28 V	1.2 W	filament lamp	quick connector 2.8 x 0.8	10,000 h	transparent colourless	1.69.523.003/1002
28 V	1.2 W	filament lamp	quick connector 2.8 x 0.8	10,000 h	transparent red	1.69.523.003/1301
28 V	1.2 W	filament lamp	quick connector 2.8 x 0.8	10,000 h	transparent yellow	1.69.523.003/1402
28 V	1.2 W	filament lamp	quick connector 2.8 x 0.8	10,000 h	transparent green	1.69.523.003/1502

Technical data see page 3 - 36





## General Data

Signal lamps with lamp socket. The standard illumination is by a filament lamp; illumination with LED is available on request. The mm specification in the product name indicates the appropriate mounting hole diameter of the signal lamps.

## Content

<b>8 mm Series - Signal lamp</b>	<b>3 - 42</b>
8 mm Series - Signal lamp, round collar	3 - 43
8 mm Series - Signal lamp, square collar	3 - 43
<b>Signal lamps with lamp socket - W 2 x 4.6d, 9.1 mm</b>	<b>3 - 44</b>
Signal lamps with lamp socket - W 2 x 4.6d, 9.1 mm, round lens	3 - 45
<b>Signal lamps with lamp socket - T 4.6, 9.1 mm</b>	<b>3 - 46</b>
Signal lamps with lamp socket - T 4.6, 9.1 mm, round lens	3 - 47
<b>Signal lamps with lamp socket - W 2x4.6d, 11.1 mm</b>	<b>3 - 48</b>
Signal lamps with lamp socket - W 2x4.6d, 11 mm, round lens	3 - 49
<b>Signal lamps with lamp socket - BA 9s (MBC/MCC), 16.2 mm</b>	<b>3 - 50</b>
Signal lamps with lamp socket - BA 9s (MBC/MCC), 16.2 mm, round lens	3 - 51
<b>Signal lamps with lamp socket - E 10 (MES), 16.2 mm</b>	<b>3 - 52</b>
Signal lamps with lamp socket - E 10 (MES), 16.2 mm, round lens	3 - 53
Signal lamps with lamp socket - E 10 (MES), 16.2 mm, round lens	3 - 54
<b>LUMOTAST FK - Signal lamp</b>	<b>3 - 56</b>
LUMOTAST FK - Signal lamp, square collar	3 - 57
LUMOTAST FK - Signal lamp, round collar	3 - 58
LUMOTAST FK - Signal lamp, rectangular collar	3 - 58
<b>LUMOTAST 25 - Signal lamp</b>	<b>3 - 60</b>
LUMOTAST 25 - Signal lamp, 24 V, „Click“ quick-assembly feature	3 - 61
LUMOTAST 25 - Signal lamp, 24 V, ring nut fixing	3 - 62
<b>LUMOTAST 75 IP40 - Signal lamp with lamp socket T 4.5</b>	<b>3 - 64</b>
LUMOTAST 75 IP40 - Signal lamp with lamp socket T 4.5, round collar, protruding lens	3 - 66
LUMOTAST 75 IP40 - Signal lamp, square collar, flush lens	3 - 66
LUMOTAST 75 IP40 - Signal lamp, rectangular collar, flush lens	3 - 67
LUMOTAST 75 IP40 - Signal lamp, square collar, protruding lens	3 - 67
Signal lamps	3 - 39

<b>LUMOTAST 75 IP65 - Signal lamp</b>	<b>3 - 68</b>
LUMOTAST 75 IP65 - Signal lamp, flush lens, square collar	3 - 70
LUMOTAST 75 IP65 - Signal lamp, protruding lens, square collar	3 - 70
LUMOTAST 75 IP65 - Signal lamp, flush lens, round collar	3 - 71
LUMOTAST 75 IP65 - Signal lamp, protruding lens, round collar	3 - 71
LUMOTAST 75 IP65 - Signal lamp, flush lens, rectangular collar	3 - 72
<b>RAFIX 16 - Signal indicator</b>	<b>3 - 74</b>
RAFIX 16 - Signal indicator, square lens	3 - 75
RAFIX 16 - Signal indicator, square collar, flush lens	3 - 76
RAFIX 16 - Signal indicator, square collar, protruding lens	3 - 76
RAFIX 16 - Signal indicator, round lens	3 - 77
RAFIX 16 - Signal indicator, round collar, flush lens	3 - 77
RAFIX 16 - Signal indicator, round collar, protruding lens	3 - 78
RAFIX 16 - Signal indicator, square collar, alignable without gaps, flush lens	3 - 78
RAFIX 16 - Signal indicator, square collar, alignable without gaps, protruding lens	3 - 79
<b>RAFIX 16 F - Signal indicator</b>	<b>3 - 80</b>
RAFIX 16 F - Signal indicator, flush lens, square black collar	3 - 81
RAFIX 16 F - Signal indicator, flush lens, round black collar	3 - 82
RAFIX 16 F - Signal indicator, flush lens, round metallized collar <b>NEW</b>	3 - 82
<b>Signal lamps with lamp socket - BA 9s (MBC/MCC), 18.2 mm</b>	<b>3 - 84</b>
Signal lamps with lamp socket - BA 9s (MBC/MCC), 18.2 mm, round lens	3 - 85
<b>Signal lamps with lamp socket - E 14, 22.3 mm</b>	<b>3 - 86</b>
Signal lamps with lamp socket - E 14, IP40, 22.3 mm	3 - 87
Signal lamps with lamp socket - E 14, 22.3 mm, screw-on lens, IP40	3 - 87
<b>RAFIX 22 QR - Signal indicator</b>	<b>3 - 88</b>
RAFIX 22 QR - Signal indicator, flat, round collar, for legend inserts	3 - 89
RAFIX 22 QR - Signal indicator, high, round collar <b>NEW</b>	3 - 90
RAFIX 22 QR - Signal indicator, flat, square collar, for legend inserts	3 - 90
RAFIX 22 QR - Signal indicator, high, square collar <b>NEW</b>	3 - 91
<b>RAFIX 22 FS - Signal indicator</b>	<b>3 - 92</b>
RAFIX 22 FS - Signal indicator, round collar, flat	3 - 93
RAFIX 22 FS - Signal indicator, round collar, high <b>NEW</b>	3 - 93
RAFIX 22 FS - Signal indicator, square collar, flat	3 - 94
RAFIX 22 FS - Signal indicator, round collar, high <b>NEW</b>	3 - 94
Signal lamps with lamp socket - E 14, 30.5 mm	3 - 96
Signal lamps with lamp socket - E 14, IP40, 30.5 mm	3 - 97
<b>Signal lamps with lamp socket - BA 15d, 30.5 mm</b>	<b>3 - 98</b>
Signal lamps with lamp socket - BA 15d, IP40, 30.5 mm	3 - 99

3

With  
Socket





## 8 mm Series - Signal lamp

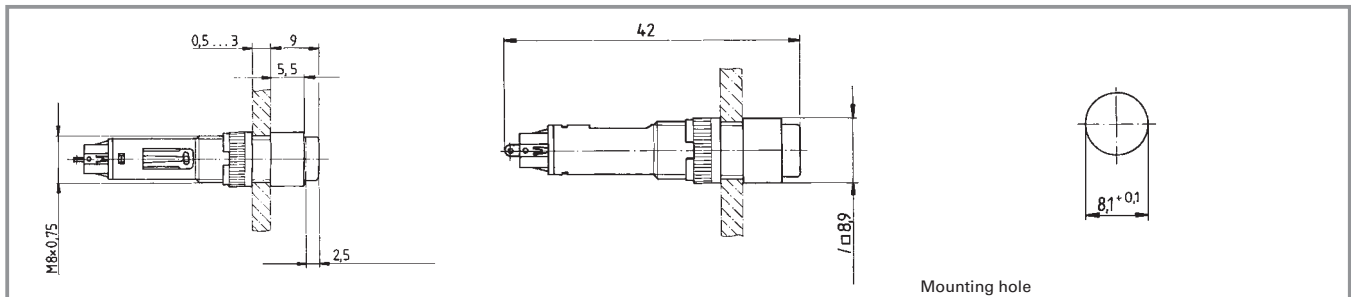

### Technical Data

#### General information

Form of lens	protruding lens
Colour of lens	see order block
Form of collar	see order block

#### Dimensions

Length of collar	8.9 mm
Width of collar	8.9 mm
Diameter of collar	see order block
Overall height	9 mm
Mounting depth	31 mm
Mounting hole	8.1 mm

#### Mechanical design

Mounting	ring nut
Terminals	solder terminals
Lamp socket	Bi-Pin T 1
Lamp	filament lamp / LED

#### Electrical characteristics

Voltage limit max.	24 V
Power limit max.	0.4 W

#### Other specifications

Degree of protection from front side	IP40
Weight	2 g
Operation temperature min.	-25 °C
Ambient temp. operating max.	+55 °C
Storage temperature min.	-40 °C
Storage temperature max.	+80 °C
Environmental resistance	acc. to IEC 60068-2 -14, -30, -33 and -78
Soldering time max.	3 s
Soldering temperature max.	350 °C

3

With  
Socket

### Typical accessories 8 mm Series - Signal lamp

Description	Photo	Order no.	Additional accessories see page
Filament lamp, Bi-Pin T 1 base, 24 - 28 V		<b>1.90.180.473/0000</b>	5 - 5
LED Bi-Pin T 1, red, 3 V		<b>1.90.691.026/0000</b>	5 - 15
LED Bi-Pin T 1, green, 3 V		<b>1.90.691.027/0000</b>	5 - 15
LED Bi-Pin T 1, yellow, 3 V		<b>1.90.691.028/0000</b>	5 - 15
Fixing spanner M 8		<b>5.58.002.027/7705</b>	5 - 21

## 8 mm Series - Signal lamp, round collar

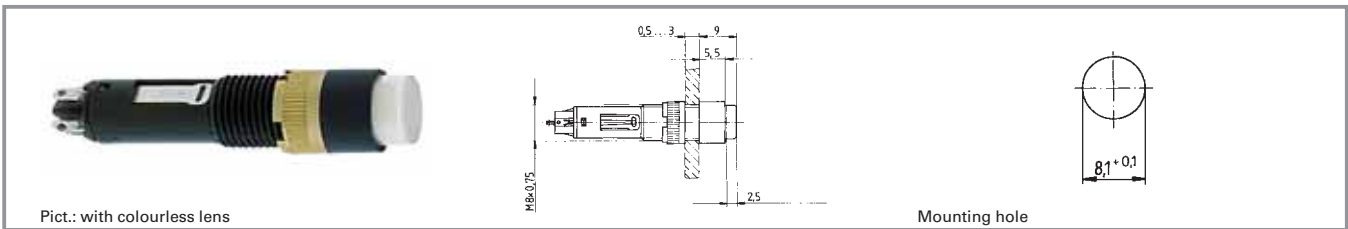

Voltage limit max.	Power limit max.	Lamp socket	Order no. without lens	Note
24 V	0.4 W	Bi-Pin T 1	1.65.120.001/0000	Please include the desired lens in your order.

Technical data see page 3 - 42

**Lenses:**

- Lens, transparent colourless: 5.05.510.359/1002
- Lens, transparent red: 5.05.510.359/1303
- Lens, transparent yellow: 5.05.510.359/1402
- Lens, transparent green: 5.05.510.359/1502

## 8 mm Series - Signal lamp, square collar

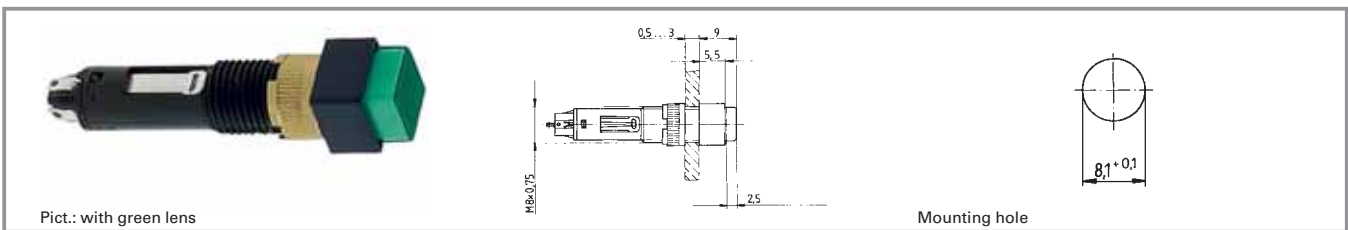

Voltage limit max.	Power limit max.	Lamp socket	Order no. without lens	Note
24 V	0.4 W	Bi-Pin T 1	1.65.120.011/0000	Please include the desired lens in your order.

Technical data see page 3 - 42

**Lenses:**

- Lens, transparent colourless: 5.05.510.360/1002
- Lens, transparent red: 5.05.510.360/1303
- Lens, transparent yellow: 5.05.510.360/1402
- Lens, transparent green: 5.05.510.360/1502

3

With Socket

## Signal lamps with lamp socket - W 2 x 4.6d, 9.1 mm

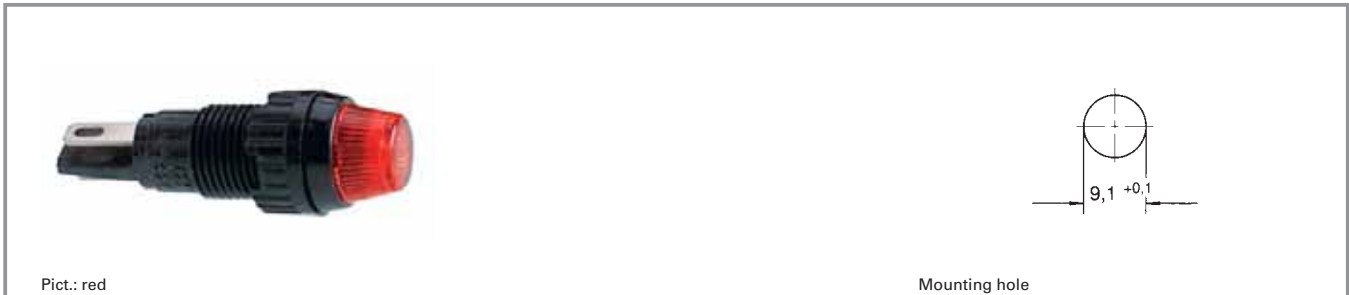

### Technical Data

#### General information

Form of lens	round
Colour of lens	see order block
Diameter of collar	11 mm

#### Dimensions

Overall height	7 mm
Mounting depth	25.5 mm
Mounting hole	9.10 mm

#### Mechanical design

Mounting	ring nut
Terminals	solder/quick connect terminals
	2.8 x 0.8 mm
Lamp socket	W 2 x 4.6d
Lamp	filament lamp

#### Electrical characteristics

Voltage limit max.	35 V
Power limit max.	1.2 W

#### Other specifications

Degree of protection from front side	IP40
Weight	1 g

### Typical accessories Signal lamps with lamp socket - W 2 x 4.6d, 9.1 mm

Description	Photo	Order no.	Additional accessories see page
Filament lamp, W 2 x 4.6d base, 24 - 30 V		<b>1.90.120.005/0000</b>	5 - 4
Filament lamp, W 2 x 4.6d base, 60 V		<b>1.90.120.009/0000</b>	5 - 4
Filament lamp, W 2 x 4.6d base, 48 V		<b>1.90.120.010/0000</b>	5 - 4
Filament lamp, W 2 x 4.6d base, 24 V		<b>1.90.120.011/0000</b>	5 - 4
Filament lamp, W 2 x 4.6d base, 12 V		<b>1.90.120.012/0000</b>	5 - 4
Fixing spanner M 9, M 10		<b>5.58.002.025/0105</b>	5 - 21

3

With Socket

## Signal lamps with lamp socket - W 2 x 4.6d, 9.1 mm, round lens

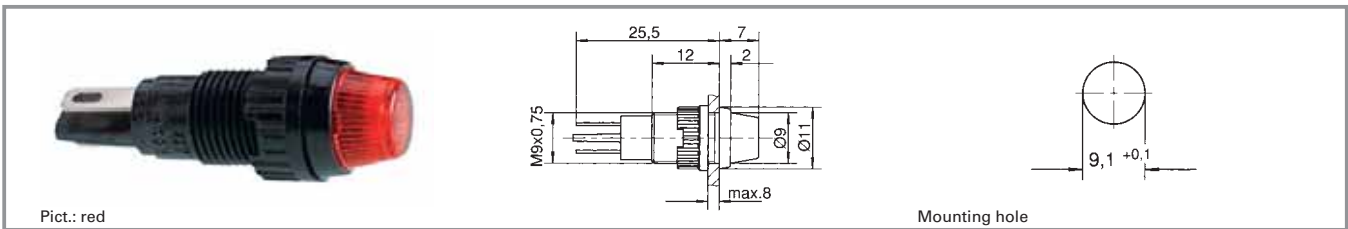

Voltage limit max.	Power limit max.	Lamp	Colour of lens	Order no. complete	Order no. single parts	
					Housing	Lens
35 V	1.2 W	filament lamp	transparent colourless	<b>1.66.001.011/1002</b>	1.66.001.026/0000	5.49.255.002/1002
35 V	1.2 W	filament lamp	transparent red	<b>1.66.001.011/1301</b>	1.66.001.026/0000	5.49.255.002/1301
35 V	1.2 W	filament lamp	transparent yellow	<b>1.66.001.011/1402</b>	1.66.001.026/0000	5.49.255.002/1402
35 V	1.2 W	filament lamp	transparent green	<b>1.66.001.011/1502</b>	1.66.001.026/0000	5.49.255.002/1502
35 V	1.2 W	filament lamp	transparent blue	<b>1.66.001.011/1601</b>	1.66.001.026/0000	5.49.255.002/1601

Technical data see page 3 - 44

Please order luminous elements separately.

## Signal lamps with lamp socket - T 4.6, 9.1 mm



### Technical Data

#### General information

Form of lens	see order block
Colour of lens	see order block
Diameter of collar	11 mm

#### Dimensions

Overall height	see order block
Mounting depth	30.5 mm
Mounting hole	9.1 mm

#### Mechanical design

Mounting	ring nut
Terminals	solder terminals
Lamp socket	T 4.6
Lamp	filament lamp

#### Electrical characteristics



Voltage limit max.	35 V
Power limit max.	1 W

#### Other specifications

Degree of protection from front side	IP40
Weight	1 g

3

### Typical accessories Signal lamps with lamp socket - T 4.6, 9.1 mm

	Description	Photo	Order no.	Additional accessories see page
With Socket	Filament lamp, T 4.6 base, 12 V		<b>1.90.100.012/0000</b>	5 - 6
	Filament lamp, T 4.6 base, 24 V		<b>1.90.100.013/0000</b>	5 - 6
	Fixing spanner M 9, M 10		<b>5.58.002.025/0105</b>	5 - 21

## Signal lamps with lamp socket - T 4.6, 9.1 mm, round lens

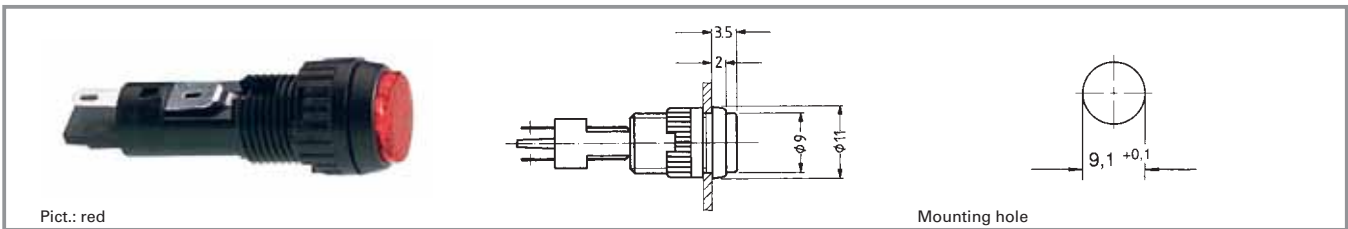

Voltage limit max.	Lamp socket	Lamp	Colour of lens	Order no. complete	Order no. single parts	
					Housing	Lens
35 V	T 4.6	filament lamp	transparent colourless	<b>1.02.157.001/1002</b>	1.02.157.021/0000	5.49.255.001/1002
35 V	T 4.6	filament lamp	transparent red	<b>1.02.157.001/1307</b>	1.02.157.021/0000	5.49.255.001/1307
35 V	T 4.6	filament lamp	transparent yellow	<b>1.02.157.001/1403</b>	1.02.157.021/0000	5.49.255.001/1403
35 V	T 4.6	filament lamp	transparent green	<b>1.02.157.001/1510</b>	1.02.157.021/0000	5.49.255.001/1510

Technical data see page 3 - 46

Please order luminous elements separately.

## Signal lamps with lamp socket - T 4.6, 9.1 mm, round lens

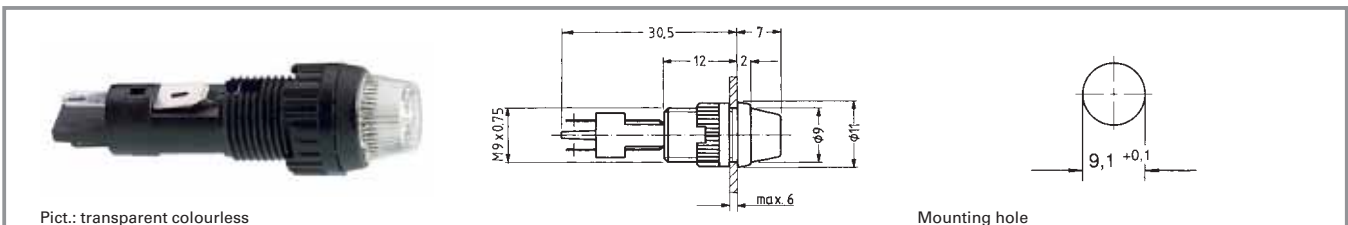

Voltage limit max.	Lamp socket	Lamp	Colour of lens	Order no. complete	Order no. single parts	
					Housing	Lens
35 V	T 4.6	filament lamp	transparent colourless	<b>1.02.157.011/1002</b>	1.02.157.021/0000	5.49.255.002/1002
35 V	T 4.6	filament lamp	transparent red	<b>1.02.157.011/1301</b>	1.02.157.021/0000	5.49.255.002/1301
35 V	T 4.6	filament lamp	transparent yellow	<b>1.02.157.011/1402</b>	1.02.157.021/0000	5.49.255.002/1402
35 V	T 4.6	filament lamp	transparent green	<b>1.02.157.011/1502</b>	1.02.157.021/0000	5.49.255.002/1502

Technical data see page 3 - 46

Please order luminous elements separately.

## Signal lamps with lamp socket - W 2x4.6d, 11.1 mm

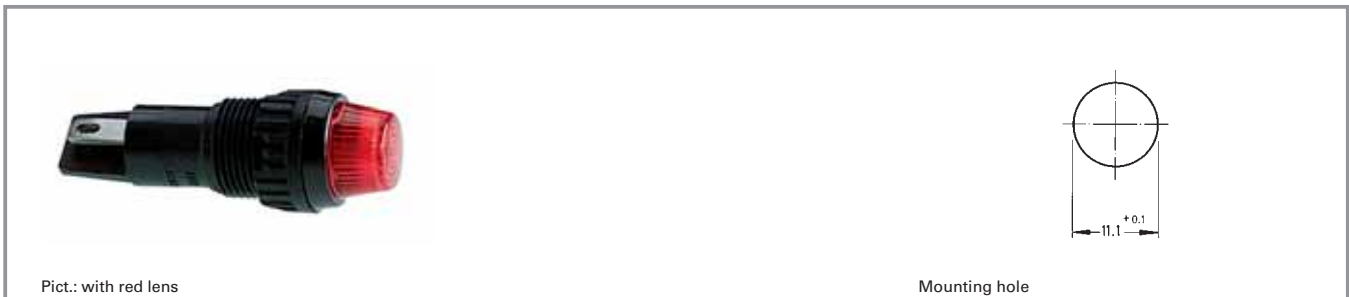

### Technical Data

#### General information

Form of lens	round
Colour of lens	see order block
Diameter of collar	11

#### Electrical characteristics

Voltage limit max.	35 V
Power limit max.	1.2 W

#### Dimensions

Overall height	8.5 mm
Mounting depth	28.5 mm
Mounting hole	11.10 mm

#### Other specifications

Degree of protection from front side	IP40
Weight	1.4 g

#### Mechanical design

Mounting	ring nut
Terminals	quick connector A 2.8 x 0.5
Lamp socket	W 2 x 4.6 d
Lamp	filament lamp

### Typical accessories Signal lamps with lamp socket - W 2x4.6d, 11.1 mm

With  
Socket

Description	Photo	Order no.	Additional accessories see page
Filament lamp, W 2 x 4.6d base, 24 - 30 V		<b>1.90.120.005/0000</b>	5 - 4
Filament lamp, W 2 x 4.6d base, 60 V		<b>1.90.120.009/0000</b>	5 - 4
Filament lamp, W 2 x 4.6d base, 48 V		<b>1.90.120.010/0000</b>	5 - 4
Filament lamp, W 2 x 4.6d base, 24 V		<b>1.90.120.011/0000</b>	5 - 4
Filament lamp, W 2 x 4.6d base, 12 V		<b>1.90.120.012/0000</b>	5 - 4
Protective sleeve made of Buna N (NBR), 8 x 30		<b>5.52.011.023/0100</b>	
Fixing spanner M 11, M 13		<b>5.58.002.026/0105</b>	5 - 21

Please include the desired lens in your order.



## Signal lamps with lamp socket - W 2x4.6d, 11 mm, round lens

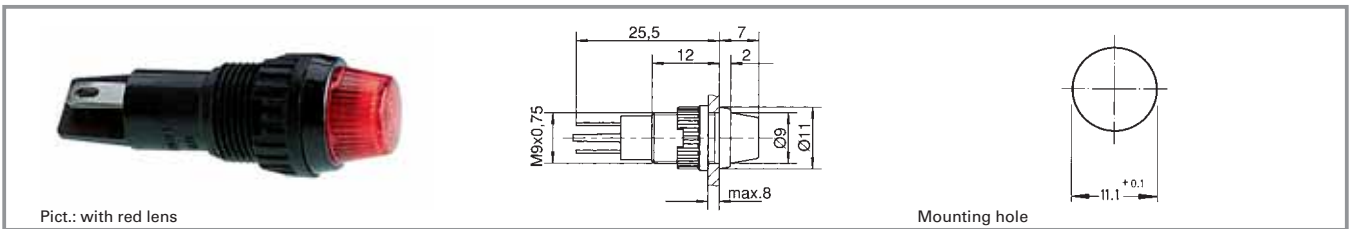

Voltage limit max.	Power limit max.	Lamp socket	Colour of lens	Order no. without lens	Note
35 V	1.2 W	W 2 x 4.6 d	-	1.66.003.091/0000	Please include the desired lens in your order.

Technical data see page 3 - 48

**Lenses:**

Lens transparent colourless: 5.49.255.003/1002

Lens transparent red: 5.49.255.003/1301

Lens transparent yellow: 5.49.255.003/1402

Lens transparent green: 5.49.255.003/1502

Please order luminous elements separately.

3

With Socket

## Signal lamps with lamp socket - BA 9s (MBC/MCC), 16.2 mm



### Technical Data

#### General information

Form of lens	see order block
Colour of lens	see order block
Diameter of collar	see order block

#### Dimensions

Overall height	see order block
Mounting depth	45.8 mm
Mounting hole	16.2 mm

#### Mechanical design

Mounting	ring nut
Terminals	solder/quick connector 6.3x0.8 / 2x2.8x0.8mm
Lamp socket	BA 9 s
Lamp	filament lamp

#### Electrical characteristics

Voltage limit max.	250 V
Power limit max.	2 W

#### Other specifications

Degree of protection from front side	see order block
Weight	10 g

3

### Approvals



VDE 0710

With  
Socket

### Typical accessories Signal lamps with lamp socket - BA 9s (MBC/MCC), 16.2 mm

Description	Photo	Order no.	Additional accessories see page
Protective sleeve for terminals made of Buna N (NBR)		<b>5.52.011.027/0100</b>	
Fixing spanner M 15, M 16		5.58.002.019/0105	5 - 21

## Signal lamps with lamp socket - BA 9s (MBC/MCC), 16.2 mm, round lens

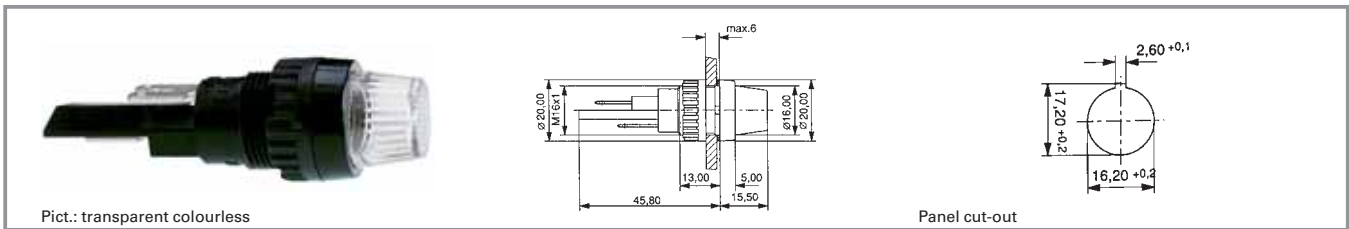

Voltage limit max.	Power limit max.	Degree of protection from front side	Colour of lens	Order no. complete	Order no. single parts	
					Housing	Lens
250 V	2 W	IP40	transparent colourless	<b>1.63.004.001/1002</b>	1.63.004.091/0000	5.49.205.013/1002
250 V	2 W	IP40	transparent red	<b>1.63.004.001/1301</b>	1.63.004.091/0000	5.49.205.013/1301
250 V	2 W	IP40	transparent yellow	<b>1.63.004.001/1402</b>	1.63.004.091/0000	5.49.205.013/1402
250 V	2 W	IP40	transparent green	<b>1.63.004.001/1502</b>	1.63.004.091/0000	5.49.205.013/1502

Technical data see page 3 - 50

**Accessoires:**

- Filament lamp, BA 9s base (MBC/MCC), 12 - 15 V: **1.90.060.132/0000**
- Filament lamp, BA 9s base (MBC/MCC), 24 - 30 V: **1.90.060.133/0000**
- Filament lamp, BA 9s base (MBC/MCC), 110 - 130 V: **1.90.060.137/0000**
- Neon lamp BA 9s (MBC/MCC), 220 V AC: **1.90.560.102/0000**

Technical data lamps see chapter 5

## Signal lamps with lamp socket - BA 9s (MBC/MCC), 16.2 mm, round lens

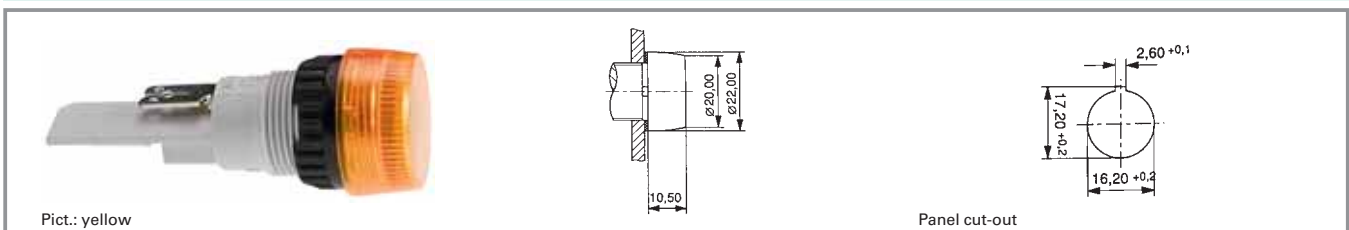

Voltage limit max.	Power limit max.	Degree of protection from front side	Colour of lens	Order no. complete	Order no. single parts	
					Housing	Lens
250 V	2 W	IP65	transparent colourless	<b>1.63.004.010/1002</b>	1.63.004.100/0000	5.49.227.007/1002
250 V	2 W	IP65	transparent red	<b>1.63.004.010/1301</b>	1.63.004.100/0000	5.49.227.007/1301
250 V	2 W	IP65	transparent yellow	<b>1.63.004.010/1402</b>	1.63.004.100/0000	5.49.227.007/1402
250 V	2 W	IP65	transparent green	<b>1.63.004.010/1502</b>	1.63.004.100/0000	5.49.227.007/1502

Technical data see page 3 - 50

**Accessoires:**

- Filament lamp, BA 9s base (MBC/MCC), 12 - 15 V: **1.90.060.003/0000**
- Filament lamp, BA 9s base (MBC/MCC), 24 - 30 V: **1.90.060.014/0000**
- Neon lamp BA 9s (MBC/MCC), 220 V AC: **1.90.560.002/0000**

Technical data lamps see chapter 5

## Signal lamps with lamp socket - E 10 (MES), 16.2 mm



Pict.: red

Screw terminals, yellow

Panel cut-out

### Technical Data

#### General information

Form of lens	round
Colour of lens	see order block
Diameter of collar	20 mm

#### Electrical characteristics

Voltage limit max.	250 V
Power limit max.	2 W

#### Dimensions

Overall height	see order block
Mounting depth	see order block
Mounting hole	16.2 mm

#### Other specifications

Degree of protection from front side	IP40
Weight	11 g

#### Mechanical design

Mounting	ring nut
Terminals	see order block
Lamp socket	E 10
Lamp	filament lamp

### Approvals



VDE 0710

With  
Socket

### Typical accessories Signal lamps with lamp socket - E 10 (MES), 16.2 mm

Description	Photo	Order no.	Additional accessories see page
Filament lamp, E 10 (MES) base, 24 - 30 V		<b>1.90.010.033/0000</b>	5 - 10
Filament lamp, E 10 (MES) base, 110 - 130 V		<b>1.90.010.037/0000</b>	5 - 10
Protective sleeve for terminals		<b>5.52.011.026/0100</b>	
Fixing spanner M 15, M 16		5.58.002.019/0105	5 - 21

## Signal lamps with lamp socket - E 10 (MES), 16.2 mm, round lens

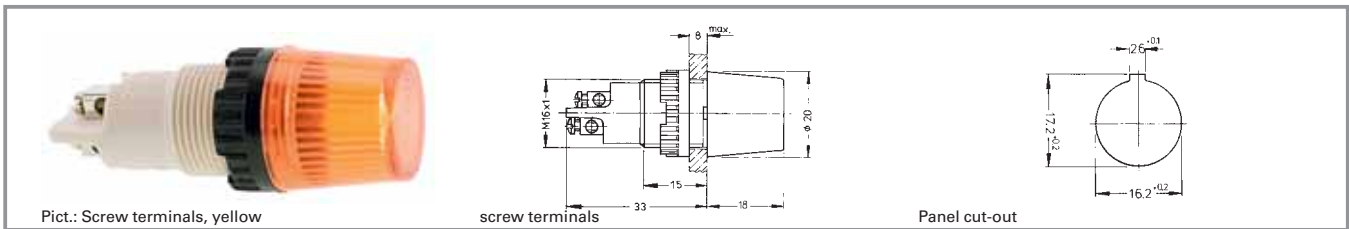

Voltage limit max.	Power limit max.	Terminals	Colour of lens	Order no. complete	Order no. single parts	
					Housing	Lens
250 V	2 W	screw terminals nickel-plated	transparent colourless	<b>1.60.502.001/1002</b>	1.60.502.099/0000	5.49.227.004/1002
250 V	2 W	screw terminals nickel-plated	transparent red	<b>1.60.502.001/1301</b>	1.60.502.099/0000	5.49.227.004/1301
250 V	2 W	screw terminals nickel-plated	transparent yellow	<b>1.60.502.001/1402</b>	1.60.502.099/0000	5.49.227.004/1402
250 V	2 W	screw terminals nickel-plated	transparent green	<b>1.60.502.001/1502</b>	1.60.502.099/0000	5.49.227.004/1502
250 V	2 W	screw terminals nickel-plated	transparent blue	<b>1.60.502.001/1601</b>	1.60.502.099/0000	5.49.227.004/1601

Technical data see page 3 - 52

## Signal lamps with lamp socket - E 10 (MES), 16.2 mm, round lens

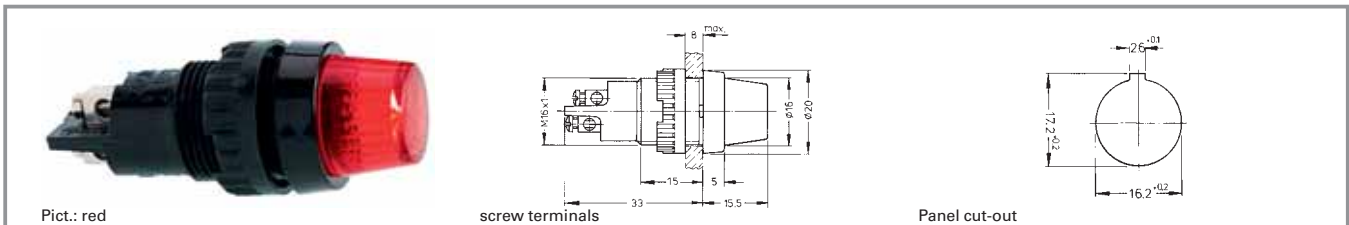

Voltage limit max.	Power limit max.	Terminals	Colour of lens	Order no. complete	Order no. single parts	
					Housing	Lens
250 V	2 W	screw terminals nickel-plated	transparent colourless	<b>1.60.502.102/1002</b>	1.60.502.091/0000	5.49.205.013/1002
250 V	2 W	screw terminals nickel-plated	transparent red	<b>1.60.502.102/1301</b>	1.60.502.091/0000	5.49.205.013/1301
250 V	2 W	screw terminals nickel-plated	transparent yellow	<b>1.60.502.102/1402</b>	1.60.502.091/0000	5.49.205.013/1402
250 V	2 W	screw terminals nickel-plated	transparent green	<b>1.60.502.102/1502</b>	1.60.502.091/0000	5.49.205.013/1502
250 V	2 W	screw terminals nickel-plated	transparent blue	<b>1.60.502.102/1601</b>	1.60.502.091/0000	5.49.205.013/1601

Technical data see page 3 - 52

Versions with 2.8 x 0.8 quick-connect terminals available on request.

## Signal lamps with lamp socket - E 10 (MES), 16.2 mm, round lens

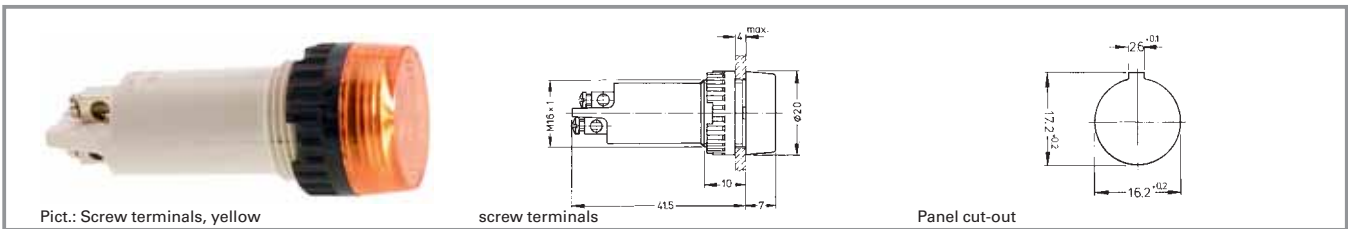

Voltage limit max.	Power limit max.	Terminals	Colour of lens	Order no. complete	Order no. single parts	
					Housing	Lens
250 V	2 W	screw terminals nickel-plated	transparent colourless	<b>1.60.502.002/1002</b>	1.60.502.098/0000	5.49.227.005/1002
250 V	2 W	screw terminals nickel-plated	transparent red	<b>1.60.502.002/1301</b>	1.60.502.098/0000	5.49.227.005/1301
250 V	2 W	screw terminals nickel-plated	transparent yellow	<b>1.60.502.002/1402</b>	1.60.502.098/0000	5.49.227.005/1402
250 V	2 W	screw terminals nickel-plated	transparent green	<b>1.60.502.002/1502</b>	1.60.502.098/0000	5.49.227.005/1502
250 V	2 W	screw terminals nickel-plated	transparent blue	<b>1.60.502.002/1601</b>	1.60.502.098/0000	5.49.227.005/1601

Technical data see page 3 - 52

3

With Socket



## LUMOTAST FK - Signal lamp

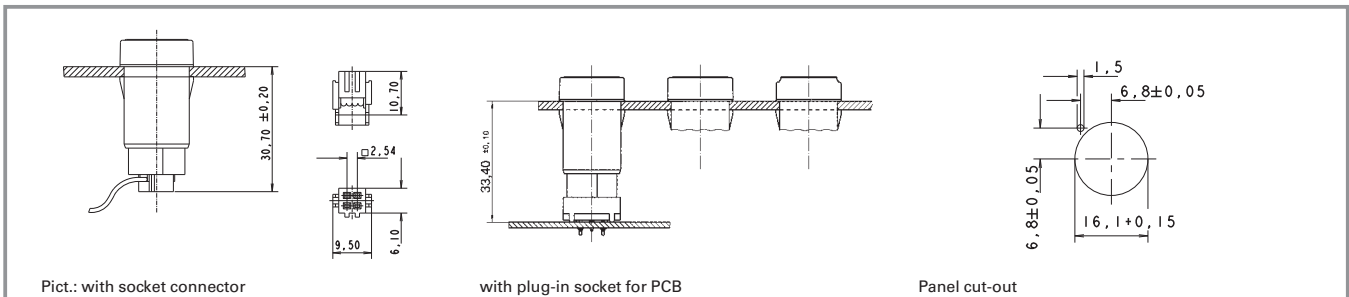

Pict.: with socket connector

with plug-in socket for PCB

Panel cut-out

### Technical Data

#### General information

Form of lens	flat lens
Colour of lens	see order block
Form of collar	see order block

#### Dimensions

Length of collar	see order block
Width of collar	see order block
Overall height	see order block
Mounting depth with connector	30.7 mm
Mounting depth with plug-in socket	33.4 mm
Mounting hole	16.2 mm

#### Mechanical design

Mounting	click quick connection
Terminals	pin connector 4-pol./ plug-in socket

Lamp socket  
Lamp

Bi-Pin T 1/T 1¼  
filament lamp / LED

#### Electrical characteristics

Voltage limit max.	24 V
Power limit max.	0.7 W

#### Other specifications

Degree of protection from front side	IP65
Weight	5 g
Operation temperature min.	-25 °C
Ambient temp. operating max.	+55 °C
Storage temperature min.	-40 °C
Storage temperature max.	+80 °C
Environmental resistance	acc. to IEC 60068-2 -14, -30, -33 and -78

3

With  
Socket

### Typical accessories LUMOTAST FK - Signal lamp

Description	Photo	Order no.	Additional accessories see page
Filament lamp, Bi-PinT 1¼ base, 12 V		<b>1.90.180.474/0000</b>	5 - 5
Filament lamp, Bi-PinT 1¼ base, 28 V		<b>1.90.180.475/0000</b>	5 - 5
LED Bi-PinT 1 superbright, red, 24 V		<b>1.90.690.351/0000</b>	5 - 15
LED Bi-PinT 1 superbright, green, 24 V		<b>1.90.690.352/0000</b>	5 - 15
LED Bi-PinT 1 superbright, yellow, 24 V		<b>1.90.690.353/0000</b>	5 - 15
LED Bi-PinT 1 superbright, blue, 24 V		<b>1.90.690.354/0000</b>	5 - 15
LED Bi-PinT 1 superbright, white, 24 V		<b>1.90.690.355/0000</b>	5 - 15



## Typical accessories LUMOTAST FK - Signal lamp

Description	Photo	Order no.	Additional accessories see page
LED Bi-PinT 1, red, 3V		<b>1.90.691.026/0000</b>	5 - 15
LED Bi-PinT 1, green, 3V		<b>1.90.691.027/0000</b>	5 - 15
LED Bi-PinT 1, yellow, 3V		<b>1.90.691.028/0000</b>	5 - 15
Plug-in socket for PCB		<b>5.00.645.036/0000</b>	5 - 23
Cable (flat ribbon cable 10 cm with socket connector and male quick connector, AMP 4-pin)		<b>5.03.771.306/0000</b>	5 - 22
Disassembly tool for LUMOTAST FK		5.05.800.041/0000	5 - 22
Flat ribbon cable, 4-wire, 1 m long		5.37.700.124/0000	5 - 23
Socket connector, 4-pin		<b>5.92.025.368/0000</b>	5 - 22

## LUMOTAST FK - Signal lamp, square collar

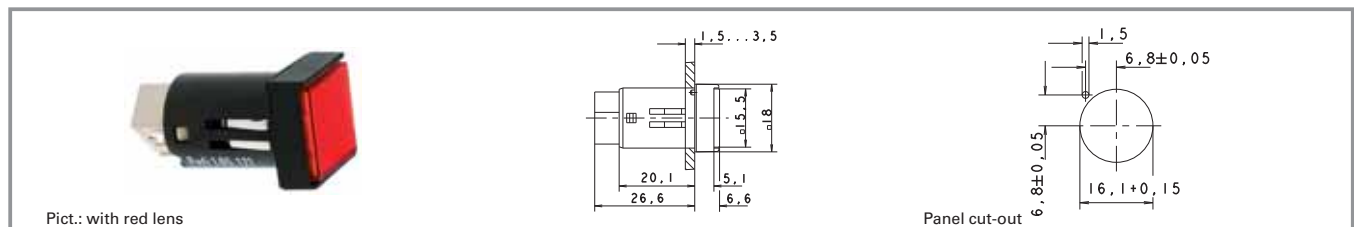

Power limit max.	Voltage limit max.	Lamp socket	Order no. without lens	Note
0.7W	24V	Bi-PinT 1/T 1¼	<b>1.65.121.906/0000</b>	Please include the desired lens in your order.

Technical data see page 3 - 56

### Lenses:

- Lens, square, transparent colourless: **5.49.075.015/1002**
- Lens, square, transparent red: **5.49.075.015/1306**
- Lens, square, transparent yellow: **5.49.075.015/1403**
- Lens, square, transparent green: **5.49.075.015/1505**
- Lens, square, transparent blue: **5.49.075.015/1607**

Do not press in lens in disassembled condition.  
A notch on the lamp socket identifies the cathode side.

## LUMOTAST FK - Signal lamp, round collar

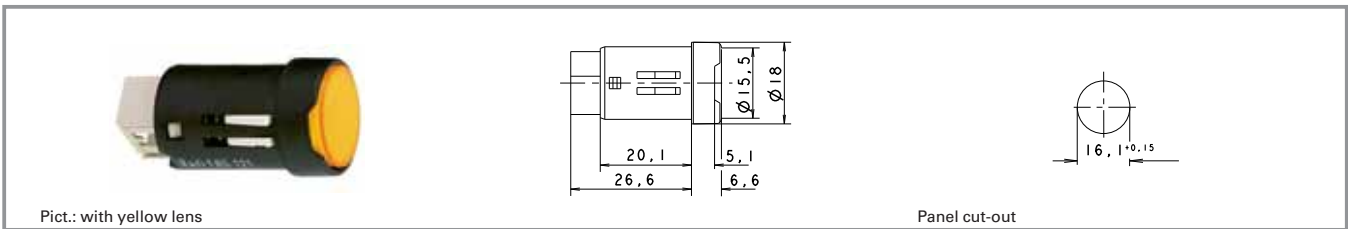

Power limit max.	Voltage limit max.	Lamp socket	Order no. without lens	Note
0.7 W	24 V	Bi-Pin T 1/T 1¼	<b>1.65.121.936/0000</b>	Please include the desired lens in your order.

Technical data see page 3 - 56

### Lenses:

- Lens, round, transparent colourless: **5.49.075.016/1002**
- Lens, round, transparent red: **5.49.075.016/1306**
- Lens, round, transparent yellow: **5.49.075.016/1403**
- Lens, round, transparent green: **5.49.075.016/1505**
- Lens, round, transparent blue: **5.49.075.016/1607**

Do not press in lens in disassembled condition.  
A notch on the lamp socket identifies the cathode side.

3

## LUMOTAST FK - Signal lamp, rectangular collar

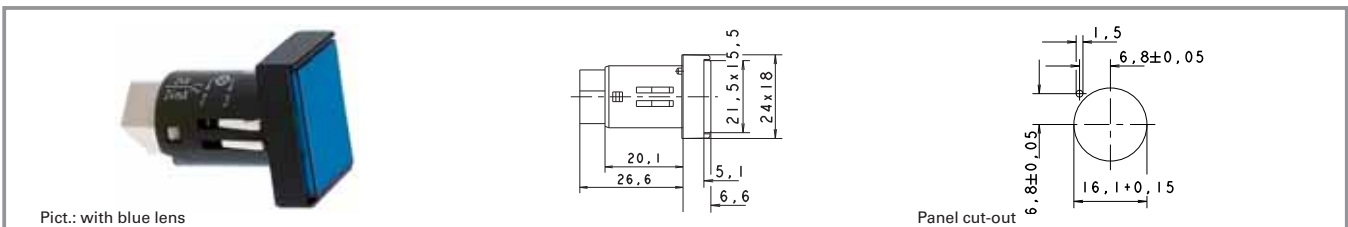

Power limit max.	Voltage limit max.	Lamp socket	Order no. without lens	Note
0.7 W	24 V	Bi-Pin T 1/T 1¼	<b>1.65.121.966/0000</b>	Please include the desired lens in your order.

Technical data see page 3 - 56

### Lenses:

- Lens, rectangular, transparent colourless: **5.49.075.017/1002**
- Lens, rectangular, transparent red: **5.49.075.017/1306**
- Lens, rectangular, transparent yellow: **5.49.075.017/1403**
- Lens, rectangular, transparent green: **5.49.075.017/1505**
- Lens, rectangular, transparent blue: **5.49.075.017/1607**

Do not press in lens in disassembled condition.  
A notch on the lamp socket identifies the cathode side.

With Socket



## LUMOTAST 25 - Signal lamp



### Technical Data

#### General information

Form of lens square  
Colour of lens see order block

#### Dimensions

Length of collar 25 mm  
Width of collar 25 mm  
Overall height 9.8 mm  
Mounting depth with connector 30.7 mm  
Mounting depth with plug-in socket 33.4 mm  
Mounting hole 16.2 mm

#### Mechanical design

Mounting see order block  
Terminals pin connector 4-pol./  
plug-in socket

Lamp socket  
Lamp

see order block  
filament lamp / LED

#### Electrical characteristics

Voltage limit max. 24 V  
Power limit max. 0.7 W

#### Other specifications

Degree of protection from front side IP65  
Weight 7 g  
Operation temperature min. -25 °C  
Ambient temp. operating max. +70 °C  
Storage temperature min. -40 °C  
Storage temperature max. +80 °C

3

With  
Socket

### Typical accessories LUMOTAST 25 - Signal lamp

Description	Photo	Order no.	Additional accessories see page
Filament lamp, Bi-PinT 1¼ base, 12 V		<b>1.90.180.474/0000</b>	5 - 5
Filament lamp, Bi-PinT 1¼ base, 28 V		<b>1.90.180.475/0000</b>	5 - 5
LED Bi-PinT 1 superbright, red, 24 V		<b>1.90.690.351/0000</b>	5 - 15
LED Bi-PinT 1 superbright, green, 24 V		<b>1.90.690.352/0000</b>	5 - 15
LED Bi-PinT 1 superbright, yellow, 24 V		<b>1.90.690.353/0000</b>	5 - 15
LED Bi-PinT 1 superbright, blue, 24 V		<b>1.90.690.354/0000</b>	5 - 15
LED Bi-PinT 1 superbright, white, 24 V		<b>1.90.690.355/0000</b>	5 - 15
LED Bi-PinT 1, red, 3 V		<b>1.90.691.026/0000</b>	5 - 15

## Typical accessories LUMOTAST 25 - Signal lamp

Description	Photo	Order no.	Additional accessories see page
LED Bi-PinT 1, green, 3V		<b>1.90.691.027/0000</b>	5 - 15
LED Bi-PinT 1, yellow, 3V		<b>1.90.691.028/0000</b>	5 - 15
Plug-in socket for PCB		<b>5.00.645.036/0000</b>	5 - 23
Cable (flat ribbon cable 10 cm with socket connector and male quick connector, AMP 4-pin)		<b>5.03.771.306/0000</b>	5 - 22
Disassembly tool for LUMOTAST 25, RAFIX 16		<b>5.05.800.042/0000</b>	2 - 94
Blanking cap complete with sealing disc and ring nut, square		<b>5.05.800.049/0100</b>	2 - 100, 5 - 26
Label holder, flush, for square collar		<b>5.07.620.004/0000</b>	2 - 96
Flat ribbon cable, 4-wire, 1 m long		5.37.700.124/0000	5 - 23
Fixing spanner M 15, M 16		5.58.002.019/0105	5 - 21
Legend insert, blank, use only for transparent lenses		<b>5.70.635.000/2000</b>	
Legend label 23 x 16 for label holder, without legend		<b>5.73.111.000/0000</b>	
Socket connector, 4-pin		<b>5.92.025.368/0000</b>	5 - 22

3

## LUMOTAST 25 - Signal lamp, 24V, „Click“ quick-assembly feature

With Socket

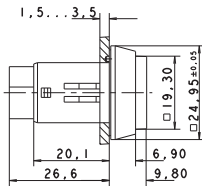
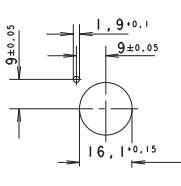
 Pict.: with red lens		 Panel cut-out		
Voltage limit max.	Power limit max.	Lamp socket	Order no. without lens	Note
24 V	0.7 W	Bi-PinT 1/T 1¼	1.65.122.906/0000	Please include the desired lens in your order.

Technical data see page 3 - 60

### Lenses:

- Lens, square, transparent colourless: 5.49.077.014/1002
- Lens, square, transparent red: 5.49.077.014/1306
- Lens, square, transparent yellow: 5.49.077.014/1403
- Lens, square, transparent green: 5.49.077.014/1505
- Lens, square, transparent blue: 5.49.077.014/1607

Do not press in lens in disassembled condition. Note when using a LED: A notch on the lamp identifies the cathode side.

## LUMOTAST 25 - Signal lamp, 24 V, ring nut fixing

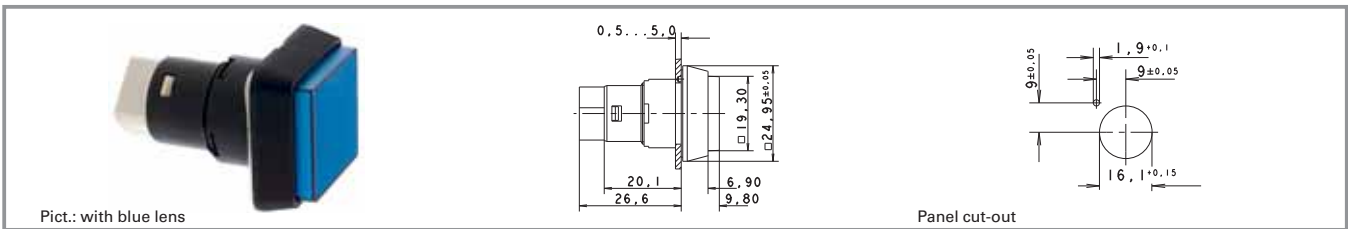

Voltage limit max.	Power limit max.	Lamp socket	Order no. without lens	Note
24 V	0.7 W	Bi-Pin T 1/T 1¼	1.65.122.956/0000	Please include the desired lens in your order.

Technical data see page 3 - 60

**Lenses:**

- Lens, square, transparent colourless: 5.49.077.014/1002
- Lens, square, transparent red: 5.49.077.014/1306
- Lens, square, transparent yellow: 5.49.077.014/1403
- Lens, square, transparent green: 5.49.077.014/1505
- Lens, square, transparent blue: 5.49.077.014/1607

Do not press in lens in disassembled condition. Note when using LED: A notch on the lamp socket identifies the cathode side.

3

With Socket



## LUMOTAST 75 IP40 - Signal lamp with lamp socket T 4.5

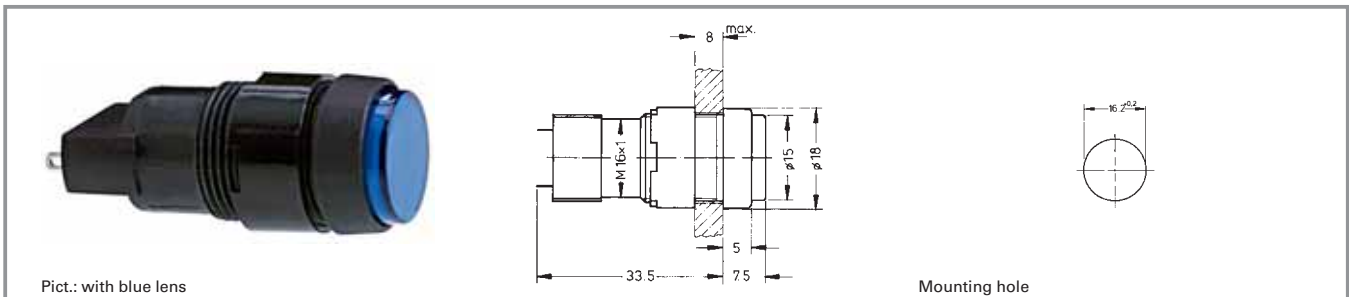

Pict.: with blue lens

Mounting hole

### Technical Data

#### General information

Form of lens	see order block
Form of collar	see order block
Colour of collar	see order block

#### Dimensions

Length of collar	see order block
Width of collar	see order block
Diameter of collar	see order block
Overall height	7.5 mm
Mounting depth	33.5 mm
Mounting hole	16.2 mm

#### Mechanical design

Mounting	ring nut
Terminals	solder terminals
Lamp socket	T 4.5
Lamp	filament lamp / LED

#### Electrical characteristics

Voltage limit max.	35 V
Power limit max.	1.2 W

#### Other specifications

Degree of protection from front side	IP40
Weight	5 g
Operation temperature min.	-25 °C
Ambient temp. operating max.	+55 °C
Storage temperature min.	-40 °C
Storage temperature max.	+80 °C
Environmental resistance	acc. to IEC 60068-2 -14, -30, -33 and -78

3

With Socket

#### Approvals



IEC 61058



UL 508



C22.2 No. 14-M91

### Typical accessories LUMOTAST 75 IP40 - Signal lamp with lamp socket T 4.5

Description	Photo	Order no.	Additional accessories see page
Filament lamp, T 4.5 base, 12 V		<b>1.90.100.022/0000</b>	5 - 6
Filament lamp, T 4.5 base, 24 V		<b>1.90.100.023/0000</b>	5 - 6
LED T 4.5 superbright, red, 24 V		<b>1.90.690.331/0000</b>	5 - 16



## Typical accessories LUMOTAST 75 IP40 - Signal lamp with lamp socket T 4.5

Description	Photo	Order no.	Additional accessories see page
LEDT 4.5 superbright, green, 24 V		<b>1.90.690.332/0000</b>	5 - 16
LEDT 4.5 superbright, yellow, 24 V		<b>1.90.690.333/0000</b>	5 - 16
LEDT 4.5 superbright, blue, 24 V		<b>1.90.690.334/0000</b>	5 - 16
LEDT 4.5 superbright, white, 24 V		<b>1.90.690.335/0000</b>	5 - 16
LEDT 4.5, red, 2-3 V (use external resistor)		<b>1.90.692.001/0000</b>	5 - 16
LEDT 4.5, green, 2-3 V (use external resistor)		<b>1.90.692.002/0000</b>	5 - 16
LEDT 4.5, yellow, 2-3 V (use external resistor)		<b>1.90.692.003/0000</b>	5 - 16
Blanking cap, black, to cover spare holes, dimensions 18 x 18 mm		5.52.006.020/0103	5 - 26
Blanking cap, black, to cover spare holes, dimensions 18 x 24 mm		5.52.006.021/0100	5 - 26
Blanking cap, black, to cover spare holes, round 18 mm		5.52.006.022/0100	5 - 26
Fixing spanner M 15, M 16		5.58.002.019/0105	5 - 21

3

With  
Socket

## LUMOTAST 75 IP40 - Signal lamp with lamp socket T 4.5, round collar, protruding lens

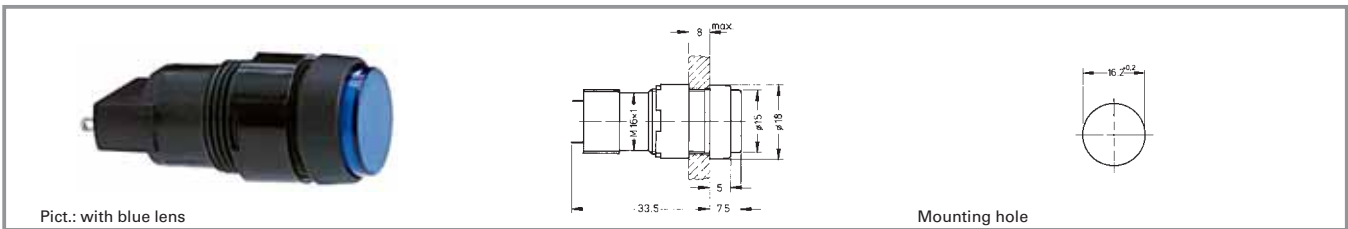

Voltage limit max.	Power limit max.	Lamp socket	Colour of collar	Order no. without lens	Note
35 V	1.2 W	T 4.5	black	<b>1.65.111.071/0000</b>	Please include the desired lens and diffuser in your order.

Technical data see page 3 - 64

### Lenses:

- Lens, round, transparent colourless, for filament lamp or LED: **5.49.257.011/1002**
- Lens, round, transparent red, for LED: **5.49.257.011/1301**
- Lens, round, transparent red, for filament lamp: **5.49.257.011/1303**
- Lens, round, transparent yellow, for filament lamp or LED: **5.49.257.011/1402**
- Lens, round, transparent green, for filament lamp: **5.49.257.011/1502**
- Lens, round, transparent green, for LED: **5.49.257.011/1503**
- Lens, round, transparent blue, for filament lamp: **5.49.257.011/1601**

### Accessoires:

- Diffuser, round, for filament lamp, without legend: **5.72.050.000/0202**
- Diffuser, round, for LED, without legend: **5.72.050.000/0214**

3

## LUMOTAST 75 IP40 - Signal lamp, square collar, flush lens

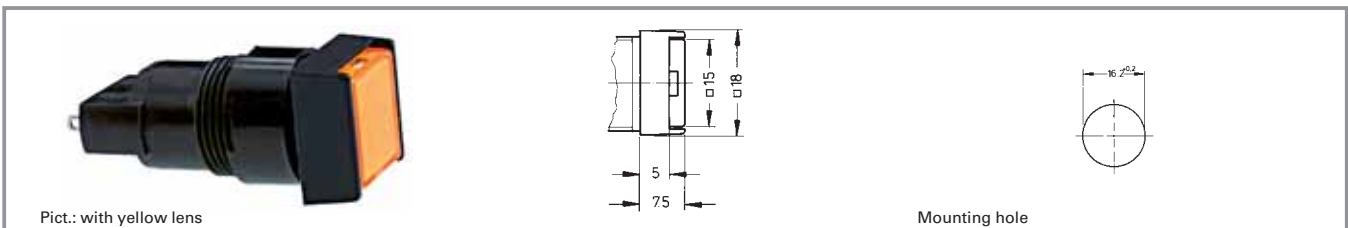

Voltage limit max.	Power limit max.	Lamp socket	Colour of collar	Order no. without lens	Note
35 V	1.2 W	T 4.5	black	<b>1.65.111.061/0000</b>	Please include the desired lens and diffuser in your order.

Technical data see page 3 - 64

### Lenses:

- Lens, rectangular, transparent colourless, for filament lamp or LED: **5.49.275.036/1002**
- Lens, rectangular, transparent red, for LED: **5.49.275.036/1301**
- Lens, rectangular, transparent red, for filament lamp: **5.49.275.036/1303**
- Lens, rectangular, transparent yellow, for filament lamp or LED: **5.49.275.036/1402**
- Lens, rectangular, transparent green, for filament lamp: **5.49.275.036/1502**
- Lens, rectangular, transparent green, for LED: **5.49.275.036/1503**
- Lens, rectangular, transparent blue, for filament lamp: **5.49.275.036/1601**

### Accessoires:

- Diffuser, square, for filament lamp, without legend: **5.73.013.000/0202**
- Diffuser, square, for LED, without legend: **5.73.013.000/0214**

With Socket

## LUMOTAST 75 IP40 - Signal lamp, rectangular collar, flush lens

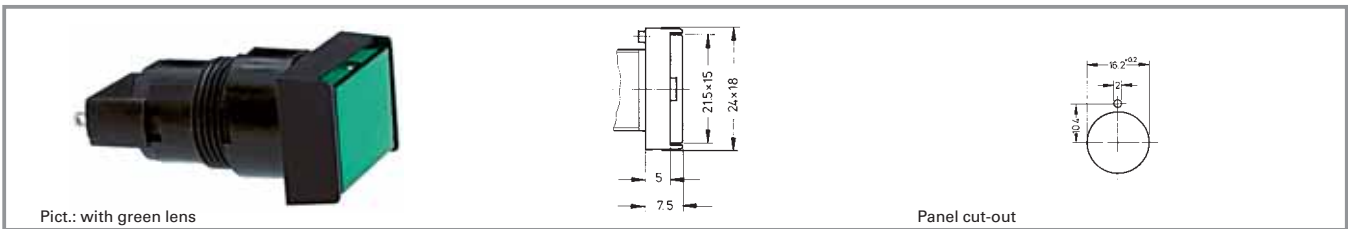

Voltage limit max.	Power limit max.	Lamp socket	Colour of collar	Order no. without lens	Note
35 V	1.2 W	T 4.5	black	<b>1.65.111.051/0000</b>	Please include the desired lens and diffuser in your order.

Technical data see page 3 - 64

**Lenses:**

- Lens, rectangular, transparent colourless, for filament lamp or LED: **5.49.275.032/1002**
- Lens, rectangular, transparent red, for LED: **5.49.275.032/1301**
- Lens, rectangular, transparent red, for filament lamp: **5.49.275.032/1303**
- Lens, rectangular, transparent yellow, for filament lamp or LED: **5.49.275.032/1402**
- Lens, rectangular, transparent green, for filament lamp: **5.49.275.032/1502**
- Lens, rectangular, transparent green, for LED: **5.49.275.032/1503**
- Lens, rectangular, transparent blue, for filament lamp: **5.49.275.032/1601**

**Accessoires:**

- Diffuser, rectangular, for filament lamp, without legend: **5.73.012.000/0202**
- Diffuser, rectangular, for LED, without legend: **5.73.012.000/0214**

## LUMOTAST 75 IP40 - Signal lamp, square collar, protruding lens

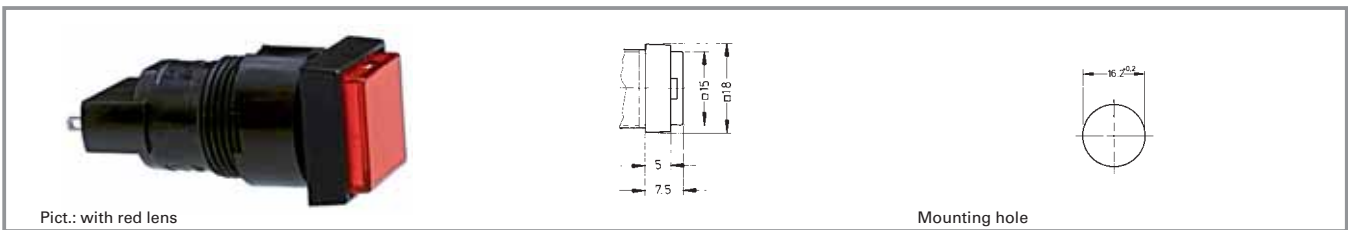

Voltage limit max.	Power limit max.	Lamp socket	Colour of collar	Order no. without lens	Note
35 V	1.2 W	T 4.5	black	<b>1.65.111.081/0000</b>	Please include the desired lens and diffuser in your order.

Technical data see page 3 - 64

**Lenses:**

- Lens, rectangular, transparent colourless, for filament lamp or LED: **5.49.275.036/1002**
- Lens, rectangular, transparent red, for LED: **5.49.275.036/1301**
- Lens, rectangular, transparent red, for filament lamp: **5.49.275.036/1303**
- Lens, rectangular, transparent yellow, for filament lamp or LED: **5.49.275.036/1402**
- Lens, rectangular, transparent green, for filament lamp: **5.49.275.036/1502**
- Lens, rectangular, transparent green, for LED: **5.49.275.036/1503**
- Lens, rectangular, transparent blue, for filament lamp: **5.49.275.036/1601**

**Accessoires:**

- Diffuser, square, for filament lamp, without legend: **5.73.013.000/0202**
- Diffuser, square, for LED, without legend: **5.73.013.000/0214**

## LUMOTAST 75 IP65 - Signal lamp

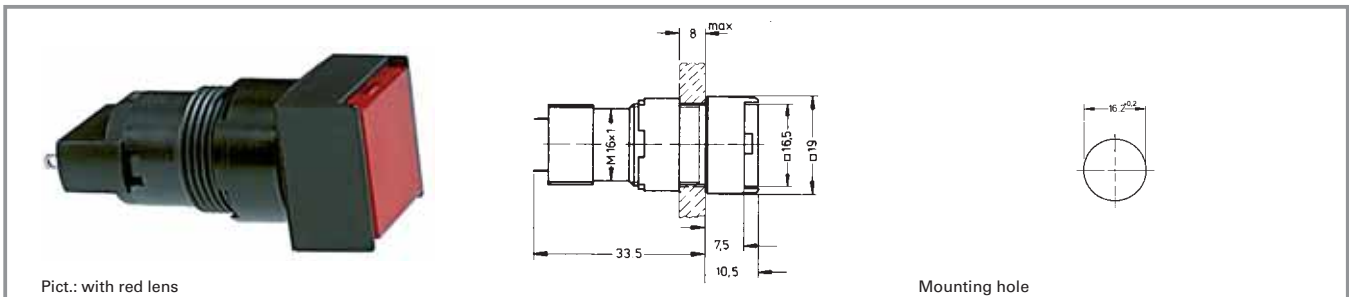

### Technical Data

#### General information

Form of lens	see order block
Form of collar	see order block
Diameter of collar	see order block

#### Dimensions

Length of collar	see order block
Width of collar	see order block
Overall height	10.5 mm
Mounting depth	33.5 mm
Mounting hole	16.2 mm

#### Mechanical design

Mounting	ring nut
Terminals	solder terminals
Lamp socket	T 4.5
Lamp	filament lamp / LED

#### Electrical characteristics

Voltage limit max.	35 V
Power limit max.	1.2 W

#### Other specifications

Degree of protection from front side	IP65
Weight	5 g
Operation temperature min.	-25 °C
Ambient temp. operating max.	+55 °C
Storage temperature min.	-40 °C
Storage temperature max.	+80 °C

### Approvals



IEC 61058



UL 508



C22.2 No. 14-M91

With Socket

### Typical accessories LUMOTAST 75 IP65 - Signal lamp

Description	Photo	Order no.	Additional accessories see page
Filament lamp, T 4.5 base, 12 V		<b>1.90.100.022/0000</b>	5 - 6
Filament lamp, T 4.5 base, 24 V		<b>1.90.100.023/0000</b>	5 - 6
LED T 4.5 superbright, red, 24 V		<b>1.90.690.331/0000</b>	5 - 16
LED T 4.5 superbright, green, 24 V		<b>1.90.690.332/0000</b>	5 - 16

## Typical accessories LUMOTAST 75 IP65 - Signal lamp

Description	Photo	Order no.	Additional accessories see page
LEDT 4.5 superbright, yellow, 24 V		<b>1.90.690.333/0000</b>	5 - 16
LEDT 4.5 superbright, blue, 24 V		<b>1.90.690.334/0000</b>	5 - 16
LEDT 4.5 superbright, white, 24 V		<b>1.90.690.335/0000</b>	5 - 16
LEDT 4.5, red, 2-3 V (use external resistor)		<b>1.90.692.001/0000</b>	5 - 16
LEDT 4.5, yellow, 2-3 V (use external resistor)		<b>1.90.692.003/0000</b>	5 - 16
Lamp extractor for lamp diameter 4 mm		<b>1.90.900.002/0000</b>	5 - 5, 5 - 6, 5 - 20
Lamp extractor for lamp diameter 5-6 mm		<b>1.90.900.004/0000</b>	5 - 16, 5 - 20
Blanking cap, black, to cover spare holes, dimensions 18 x 18 mm		5.52.006.020/0103	5 - 26
Blanking cap, black, to cover spare holes, dimensions 18 x 24 mm		5.52.006.021/0100	5 - 26
Blanking cap, black, to cover spare holes, round 18 mm		5.52.006.022/0100	5 - 26
Fixing spanner M 15, M 16		5.58.002.019/0105	5 - 21

## LUMOTAST 75 IP65 - Signal lamp, flush lens, square collar

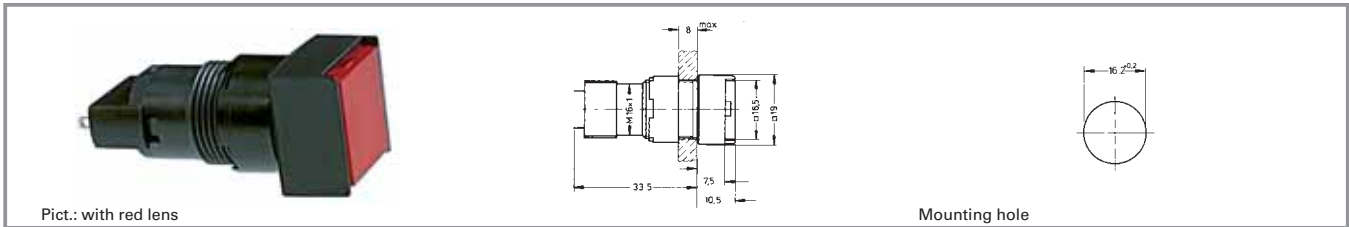

Voltage limit max.	Power limit max.	Lamp socket	Form of collar	Order no. without lens	Note
35 V	1.2 W	T 4.5	square	<b>1.65.111.066/0000</b>	Please include the desired lens in your order.

Technical data see page 3 - 68

### Lenses:

- Lens, square, transparent colourless, for filament lamp or LED: **5.49.277.052/1002**
- Lens, square, transparent red, for LED: **5.49.277.052/1301**
- Lens, square, transparent red, for filament lamp: **5.49.277.052/1303**
- Lens, square, transparent yellow, for filament lamp or LED: **5.49.277.052/1402**
- Lens, square, transparent green, for filament lamp: **5.49.277.052/1502**
- Lens, square, transparent green, for LED: **5.49.277.052/1503**
- Lens, square, transparent blue, for filament lamp: **5.49.277.052/1601**

### Accessoires:

Legend insert, square, without legend: **5.70.629.000/2000**

For assembly, press the lens as far as possible.

3

## LUMOTAST 75 IP65 - Signal lamp, protruding lens, square collar

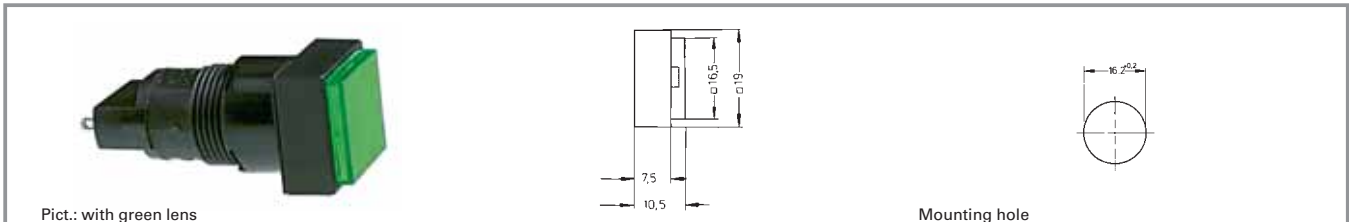

Voltage limit max.	Power limit max.	Lamp socket	Form of collar	Order no. without lens	Note
35 V	1.2 W	T 4.5	square	<b>1.65.111.086/0000</b>	Please include the desired lens in your order.

Technical data see page 3 - 68

### Lenses:

- Lens, square, transparent colourless, for filament lamp or LED: **5.49.277.052/1002**
- Lens, square, transparent red, for LED: **5.49.277.052/1301**
- Lens, square, transparent red, for filament lamp: **5.49.277.052/1303**
- Lens, square, transparent yellow, for filament lamp or LED: **5.49.277.052/1402**
- Lens, square, transparent green, for filament lamp: **5.49.277.052/1502**
- Lens, square, transparent green, for LED: **5.49.277.052/1503**
- Lens, square, transparent blue, for filament lamp: **5.49.277.052/1601**

### Accessoires:

Legend insert, square, without legend: **5.70.629.000/2000**

For assembly, press the lens as far as possible.

With Socket

## LUMOTAST 75 IP65 - Signal lamp, flush lens, round collar

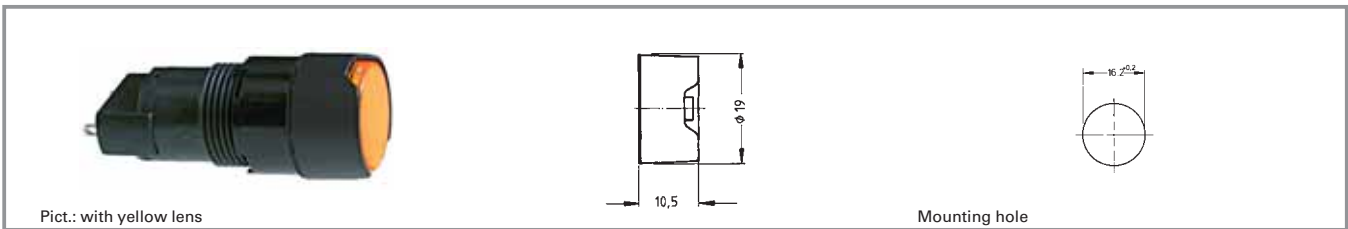

Voltage limit max.	Power limit max.	Lamp socket	Form of collar	Order no. without lens	Note
35 V	1.2 W	T 4.5	round	<b>1.65.111.096/0000</b>	Please include the desired lens in your order.

Technical data see page 3 - 68

**Lenses:**

- Lens, round, transparent colourless, for filament lamp or LED: **5.49.259.013/1002**
- Lens, round, transparent red, for LED: **5.49.259.013/1301**
- Lens, round, transparent red, for filament lamp: **5.49.259.013/1303**
- Lens, round, transparent yellow, for filament lamp or LED: **5.49.259.013/1402**
- Lens, round, transparent green, for filament lamp: **5.49.259.013/1502**
- Lens, round, transparent green, for LED: **5.49.259.013/1503**
- Lens, round, transparent blue, for filament lamp: **5.49.259.013/1601**

**Accessoires:**

Legend insert, round, without legend: **5.70.059.000/2000**

For assembly, press the lens as far as possible.

3

## LUMOTAST 75 IP65 - Signal lamp, protruding lens, round collar

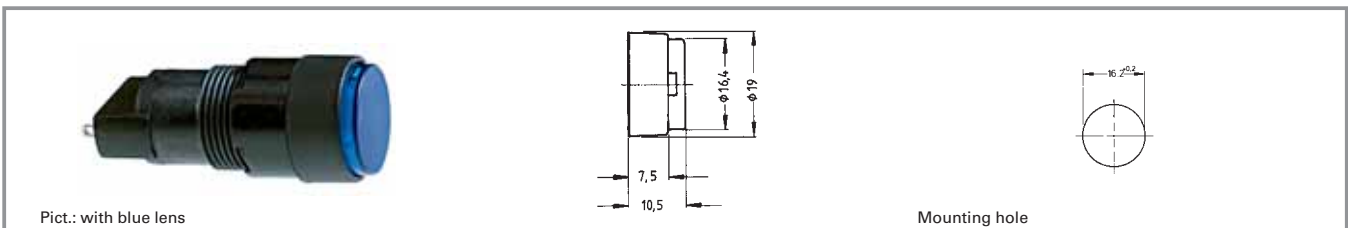

Voltage limit max.	Power limit max.	Lamp socket	Form of collar	Order no. without lens	Note
35 V	1.2 W	T 4.5	round	<b>1.65.111.076/0000</b>	Please include the desired lens in your order.

Technical data see page 3 - 68

**Lenses:**

- Lens, round, transparent colourless, for filament lamp or LED: **5.49.259.013/1002**
- Lens, round, transparent red, for LED: **5.49.259.013/1301**
- Lens, round, transparent red, for filament lamp: **5.49.259.013/1303**
- Lens, round, transparent yellow, for filament lamp or LED: **5.49.259.013/1402**
- Lens, round, transparent green, for filament lamp: **5.49.259.013/1502**
- Lens, round, transparent green, for LED: **5.49.259.013/1503**
- Lens, round, transparent blue, for filament lamp: **5.49.259.013/1601**

**Accessoires:**

Legend insert, round, without legend: **5.70.059.000/2000**

For assembly, press the lens as far as possible.

With Socket

## LUMOTAST 75 IP65 - Signal lamp, flush lens, rectangular collar

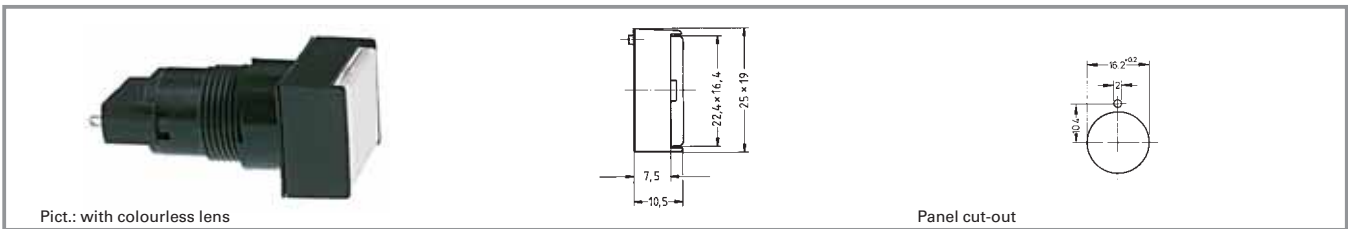

Voltage limit max.	Power limit max.	Lamp socket	Form of collar	Order no. without lens	Note
35 V	1.2 W	T 4.5	rectangular	1.65.111.056/0000	Please include the desired lens in your order.

Technical data see page 3 - 68

### Lenses:

- Lens, rectangular, transparent colourless, for filament lamp or LED: 5.49.277.058/1002
- Lens, rectangular, transparent red, for LED: 5.49.277.058/1301
- Lens, rectangular, transparent red, for filament lamp: 5.49.277.058/1303
- Lens, rectangular, transparent yellow, for filament lamp or LED: 5.49.277.058/1402
- Lens, rectangular, transparent green, for filament lamp: 5.49.277.058/1502
- Lens, rectangular, transparent green, for LED: 5.49.277.058/1503
- Lens, rectangular, transparent blue, for filament lamp: 5.49.277.058/1601

### Accessoires:

- Legend insert, rectangular without legend: 5.70.630.000/2000

For assembly, press the lens as far as possible.

3

With  
Socket





## RAFIX 16 - Signal indicator

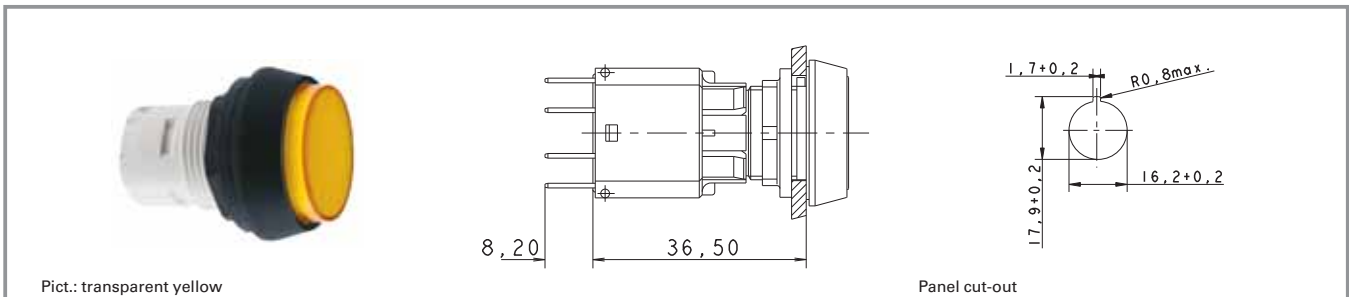

### Technical Data

#### General information

Form of lens	see order block
Colour of lens	see order block
Form of collar	see order block

#### Dimensions

Collar dimensions	see order block
Overall height	see order block
Mounting depth	30.5 / 44.7 mm
Mounting hole	16.2 mm
Key grid	25 x 25 mm

#### Mechanical design

Mounting	ring nut
----------	----------

#### Other specifications

Degree of protection from front side	IP65
Operation temperature min.	-25 °C
Ambient temp. operating max. without lamp /LED	+70 °C
Ambient temp. operating max. with lamp /LED	+55 °C
Storage temperature min.	-40 °C
Storage temperature max.	+85 °C
Environmental resistance	acc. to IEC 60068-2 -14, -30, -33 and -78

#### Approvals



IEC 61058



C22.2 No. 14-M91

With  
Socket

### Typical accessories RAFIX 16 - Signal indicator

Description	Photo	Order no.	Additional accessories see page
RAFIX 16 - Lamp socket W 2 x 4.6 d, quick-connect terminals		<b>1.71.212.001/0000</b>	2 - 91
RAFIX 16 - Lamp socket W 2 x 4.6 d, quick-connect terminals		<b>1.71.212.011/0000</b>	2 - 91
LED W 2 x 4.6d superbright, white, 24 V		<b>1.90.690.365/0000</b>	5 - 14
Disassembly tool for LUMOTAST 25, RAFIX 16		<b>5.05.800.042/0000</b>	2 - 94
Label holder, flush, for square collar		<b>5.07.620.004/0000</b>	2 - 96

## Typical accessories RAFIX 16 - Signal indicator

Description	Photo	Order no.	Additional accessories see page
Fixing spanner for hexagon nut		<b>5.58.002.034/0000</b>	2 - 95

For suitable LEDs and filament lamps, refer to the chapter „RAFIX 16 lamp sockets“; for additional accessories, refer to the chapter „RAFIX 16 special accessories“.

## RAFIX 16 - Signal indicator, square lens

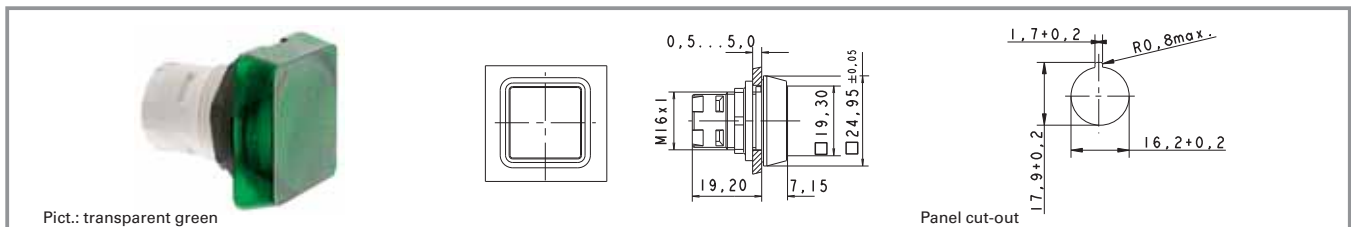

Form of lens	Colour of lens	Order no. complete	Order no. single parts	
			Housing	Lens
lens square	transparent colourless	<b>1.65.124.001/1002</b>	1.65.124.101/0000	5.49.263.006/1002
lens square	transparent red	<b>1.65.124.001/1306</b>	1.65.124.101/0000	5.49.263.006/1306
lens square	transparent yellow	<b>1.65.124.001/1403</b>	1.65.124.101/0000	5.49.263.006/1403
lens square	transparent green	<b>1.65.124.001/1505</b>	1.65.124.101/0000	5.49.263.006/1505
lens square	transparent blue	<b>1.65.124.001/1607</b>	1.65.124.101/0000	5.49.263.006/1607

Technical data see page 3 - 74

Legending can only be made externally on a label holder.

3

With  
Socket

## RAFIX 16 - Signal indicator, square collar, flush lens

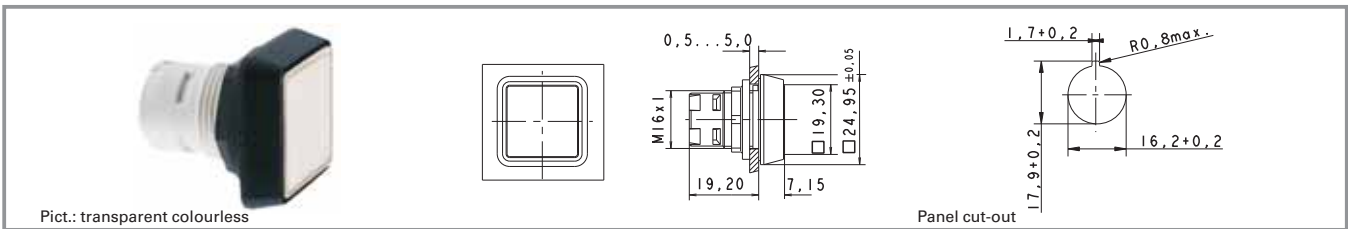

Form of lens	Colour of lens	Order no. complete	Order no. single parts	
			Housing	Lens
flat lens	transparent colourless	1.65.124.301/1002	1.65.124.401/0000	5.49.077.011/1002
flat lens	transparent red	1.65.124.301/1306	1.65.124.401/0000	5.49.077.011/1306
flat lens	transparent yellow	1.65.124.301/1403	1.65.124.401/0000	5.49.077.011/1403
flat lens	transparent green	1.65.124.301/1505	1.65.124.401/0000	5.49.077.011/1505
flat lens	transparent blue	1.65.124.301/1607	1.65.124.401/0000	5.49.077.011/1607

Technical data see page 3 - 74

**Accessoires:**

Legend insert, blank, use only for transparent lenses: 5.70.635.000/2000

3

## RAFIX 16 - Signal indicator, square collar, protruding lens

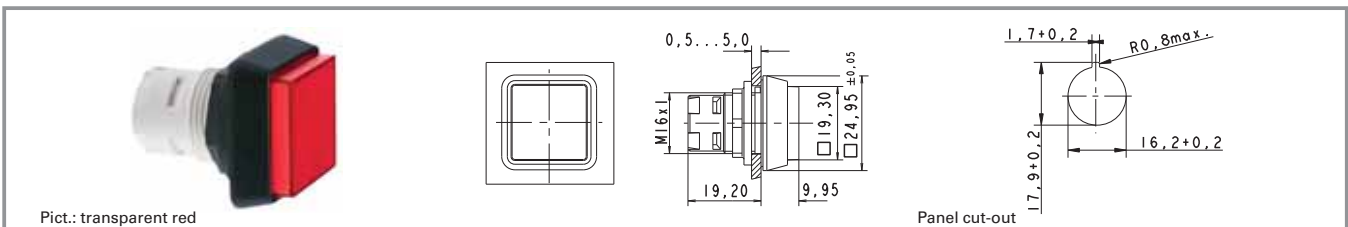

Form of lens	Colour of lens	Order no. complete	Order no. single parts	
			Housing	Lens
protruding lens	transparent colourless	1.65.124.351/1002	1.65.124.451/0000	5.49.077.012/1002
protruding lens	transparent red	1.65.124.351/1306	1.65.124.451/0000	5.49.077.012/1306
protruding lens	transparent yellow	1.65.124.351/1403	1.65.124.451/0000	5.49.077.012/1403
protruding lens	transparent green	1.65.124.351/1505	1.65.124.451/0000	5.49.077.012/1505
protruding lens	transparent blue	1.65.124.351/1607	1.65.124.451/0000	5.49.077.012/1607

Technical data see page 3 - 74

**Accessoires:**

Legend insert, blank, use only for transparent lenses: 5.70.635.000/2000

With  
Socket

## RAFIX 16 - Signal indicator, round lens

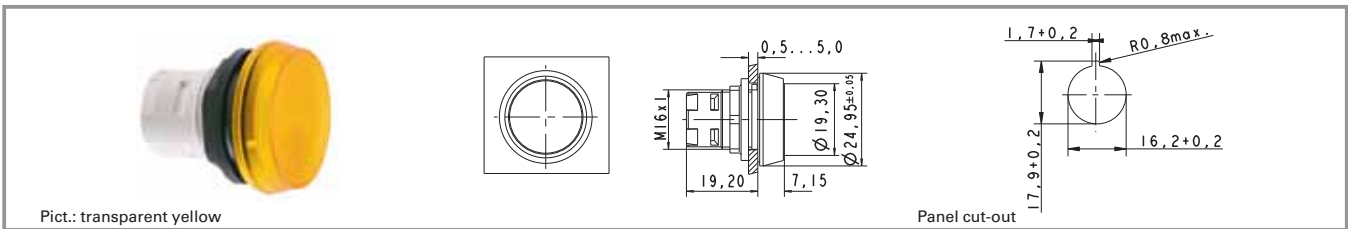

Form of lens	Colour of lens	Order no. complete	Order no. single parts	
			Housing	Lens
lens round	transparent colourless	<b>1.65.124.021/1002</b>	1.65.124.101/0000	5.49.263.007/1002
lens round	transparent red	<b>1.65.124.021/1306</b>	1.65.124.101/0000	5.49.263.007/1306
lens round	transparent yellow	<b>1.65.124.021/1403</b>	1.65.124.101/0000	5.49.263.007/1403
lens round	transparent green	<b>1.65.124.021/1505</b>	1.65.124.101/0000	5.49.263.007/1505

Technical data see page 3 - 74

Legending can only be made externally on a label holder.

## RAFIX 16 - Signal indicator, round collar, flush lens

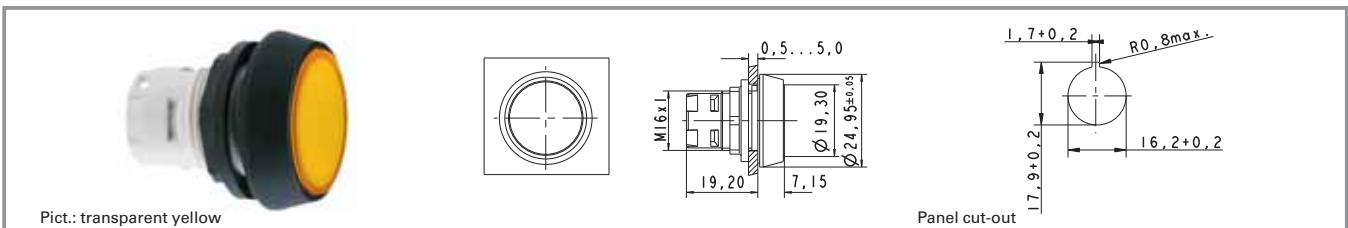

Form of lens	Colour of lens	Order no. complete	Order no. single parts	
			Housing	Lens
flat lens	transparent colourless	1.65.124.321/1002	1.65.124.421/0000	5.49.259.017/1002
flat lens	transparent red	1.65.124.321/1306	1.65.124.421/0000	5.49.259.017/1306
flat lens	transparent yellow	1.65.124.321/1403	1.65.124.421/0000	5.49.259.017/1403
flat lens	transparent green	1.65.124.321/1505	1.65.124.421/0000	5.49.259.017/1505
flat lens	transparent blue	1.65.124.321/1607	1.65.124.421/0000	5.49.259.017/1607

Technical data see page 3 - 74

### Accessoires:

Legend insert, blank, use only for transparent lenses: **5.70.637.000/2000**

## RAFIX 16 - Signal indicator, round collar, protruding lens

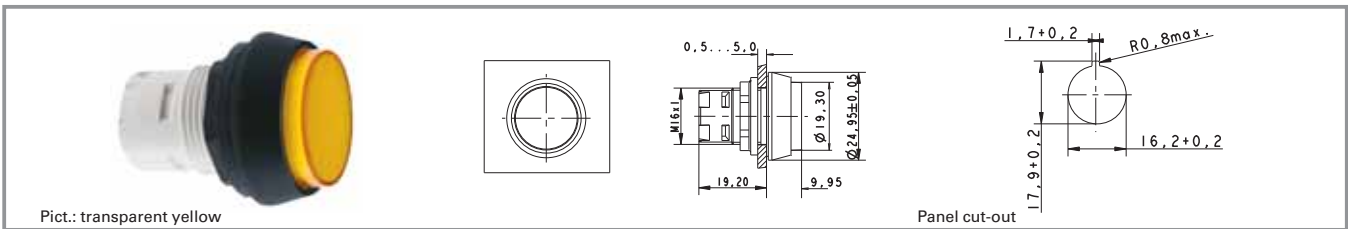

Form of lens	Colour of lens	Order no. complete	Order no. single parts	
			Housing	Lens
protruding lens	transparent colourless	1.65.124.371/1002	1.65.124.471/0000	5.49.259.018/1002
protruding lens	transparent red	1.65.124.371/1306	1.65.124.471/0000	5.49.259.018/1306
protruding lens	transparent yellow	1.65.124.371/1403	1.65.124.471/0000	5.49.259.018/1403
protruding lens	transparent green	1.65.124.371/1505	1.65.124.471/0000	5.49.259.018/1505
protruding lens	transparent blue	1.65.124.371/1607	1.65.124.471/0000	5.49.259.018/1607

Technical data see page 3 - 74

**Accessoires:**

Legend insert, blank, use only for transparent lenses: 5.70.637.000/2000

3

## RAFIX 16 - Signal indicator, square collar, alignable without gaps, flush lens

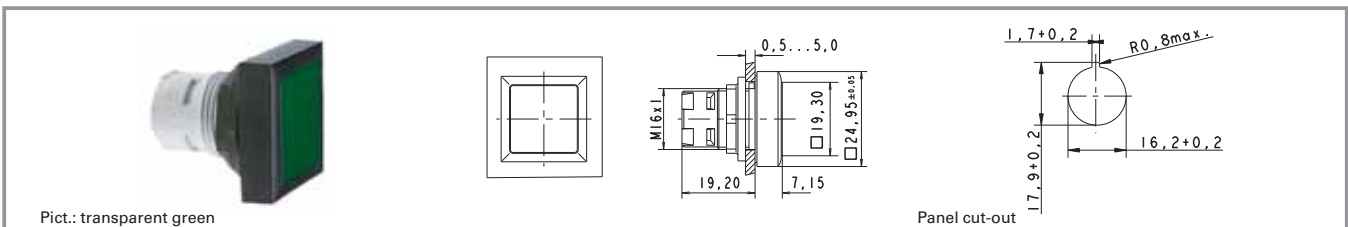

Form of lens	Colour of lens	Order no. complete	Order no. single parts	
			Housing	Lens
flat lens	transparent colourless	1.65.124.551/1002	1.65.124.651/0000	5.49.077.011/1002
flat lens	transparent red	1.65.124.551/1306	1.65.124.651/0000	5.49.077.011/1306
flat lens	transparent yellow	1.65.124.551/1403	1.65.124.651/0000	5.49.077.011/1403
flat lens	transparent green	1.65.124.551/1505	1.65.124.651/0000	5.49.077.011/1505
flat lens	transparent blue	1.65.124.551/1607	1.65.124.651/0000	5.49.077.011/1607

Technical data see page 3 - 74

**Accessoires:**

Legend insert, blank, use only for transparent lenses: 5.70.635.000/2000

With  
Socket

## RAFIX 16 - Signal indicator, square collar, alignable without gaps, protruding lens



Pict.: transparent red

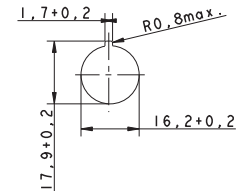

Panel cut-out

Form of lens	Colour of lens	Order no. complete	Order no. single parts	
			Housing	Lens
protruding lens	transparent colourless	1.65.124.501/1002	1.65.124.661/0000	5.49.077.012/1002
protruding lens	transparent red	1.65.124.501/1306	1.65.124.661/0000	5.49.077.012/1306
protruding lens	transparent yellow	1.65.124.501/1403	1.65.124.661/0000	5.49.077.012/1403
protruding lens	transparent green	1.65.124.501/1505	1.65.124.661/0000	5.49.077.012/1505
protruding lens	transparent blue	1.65.124.501/1607	1.65.124.661/0000	5.49.077.012/1607

Technical data see page 3 - 74

**Accessoires:**

Legend insert, blank, use only for transparent lenses: 5.70.635.000/2000

## RAFIX 16 F - Signal indicator



### Technical Data

#### General information

Form of lens	see order block
Colour of lens	see order block
Form of collar	see order block
Colour of collar	see order block

#### Dimensions

Collar dimensions	see order block
Overall height	see order block
Mounting depth with contact block	50 mm
Key grid	see order block
Mounting hole	see order block

#### Mechanical design

Mounting	ring nut
Contact function	-
Illumination	yes

#### Other specifications

Operating life (operations)	-
Degree of protection from front side	IP65
Operation temperature min. Ambient temp. operating max. without lamp /LED	-25 °C
Ambient temp. operating max. with lamp /LED	-
Storage temperature min.	+55 °C
Storage temperature max.	-40 °C
Environmental resistance	+85 °C
	acc. to IEC 60068-2
	-14, -30, -33 and -78

3

With Socket

#### Approvals



IEC 61058

### Typical accessories RAFIX 16 F - Signal indicator

Description	Photo	Order no.	Additional accessories see page
RAFIX 16 - Lamp socket W 2 x 4.6 d, quick-connect terminals		<b>1.71.212.001/0000</b>	2 - 91
RAFIX 16 - Lamp socket W 2 x 4.6 d, quick-connect terminals		<b>1.71.212.011/0000</b>	2 - 91
LED W 2 x 4.6d superbright, white, 24 V		<b>1.90.690.365/0000</b>	5 - 14



## Typical accessories RAFIX 16 F - Signal indicator

Description	Photo	Order no.	Additional accessories see page
Disassembly tool for LUMOTAST 25, RAFIX 16		<b>5.05.800.042/0000</b>	2 - 94
Fixing spanner for hexagon nut		<b>5.58.002.034/0000</b>	2 - 95
Legend insert, blank, use only for transparent lenses		<b>5.70.635.000/2000</b>	

For additional accessories, refer to the chapter „RAFIX 16 special accessories“

## RAFIX 16 F - Signal indicator, flush lens, square black collar

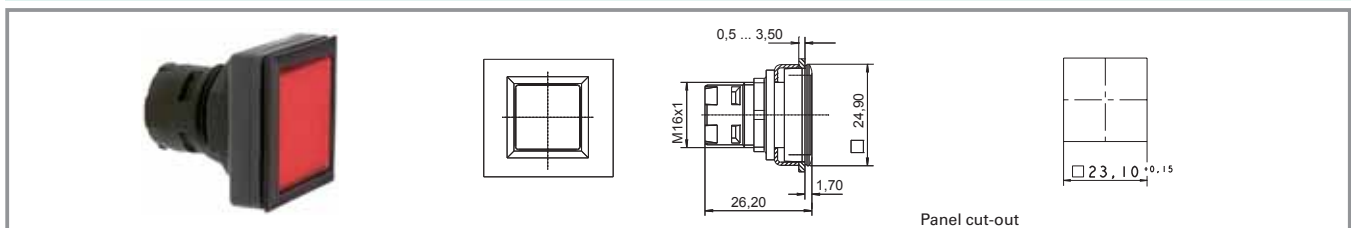

Colour of collar	Form of lens	Overall height	Colour of lens	Order no. complete	Order no. single parts	
					Housing	Lens
black	flat lens	1.7 mm	transparent colourless	<b>1.65.126.301/1000</b>	1.65.126.401/0000	<b>5.49.077.011/1002</b>
black	flat lens	1.7 mm	transparent red	<b>1.65.126.301/1300</b>	1.65.126.401/0000	<b>5.49.077.011/1306</b>
black	flat lens	1.7 mm	transparent yellow	<b>1.65.126.301/1400</b>	1.65.126.401/0000	<b>5.49.077.011/1403</b>
black	flat lens	1.7 mm	transparent green	<b>1.65.126.301/1500</b>	1.65.126.401/0000	<b>5.49.077.011/1505</b>
black	flat lens	1.7 mm	transparent blue	<b>1.65.126.301/1600</b>	1.65.126.401/0000	<b>5.49.077.011/1607</b>

Technical data see page 3 - 80

**Accessoires:**

Legend insert, blank, use only for transparent lenses: **5.70.635.000/2000**

## RAFIX 16 F - Signal indicator, flush lens, round black collar

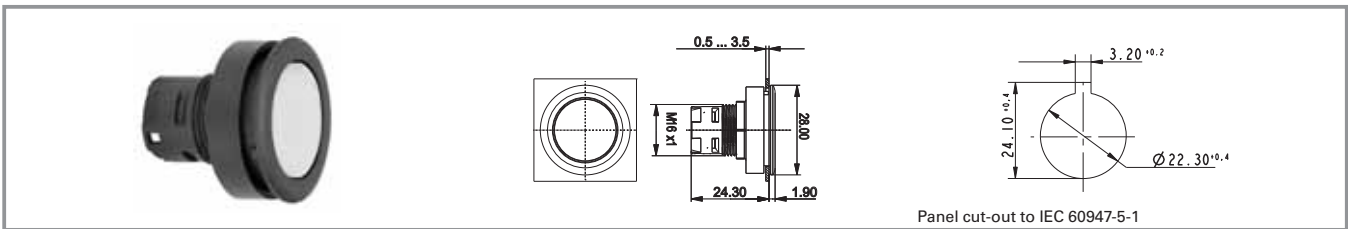

Panel cut-out to IEC 60947-5-1

Colour of collar	Form of lens	Overall height	Colour of lens	Order no. complete	Order no. single parts	
					Housing	Lens
black	flat lens	1.9 mm	transparent colourless	<b>1.65.126.001/1000</b>	1.65.126.101/0000	5.49.259.017/1002
black	flat lens	1.9 mm	transparent red	<b>1.65.126.001/1300</b>	1.65.126.101/0000	5.49.259.017/1306
black	flat lens	1.9 mm	transparent yellow	<b>1.65.126.001/1400</b>	1.65.126.101/0000	5.49.259.017/1403
black	flat lens	1.9 mm	transparent green	<b>1.65.126.001/1500</b>	1.65.126.101/0000	5.49.259.017/1505
black	flat lens	1.9 mm	transparent blue	<b>1.65.126.001/1600</b>	1.65.126.101/0000	5.49.259.017/1607

Technical data see page 3 - 80

3

## RAFIX 16 F - Signal indicator, flush lens, round metallized collar

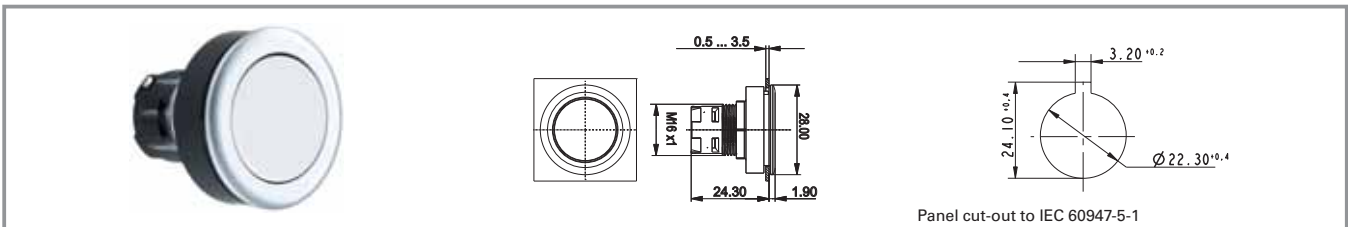

Panel cut-out to IEC 60947-5-1

Colour of collar	Form of lens	Overall height	Colour of lens	Order no. complete	Order no. single parts	
					Housing	Lens
metallic	flat lens	1.9 mm	transparent colourless	<b>1.65.126.011/1000</b>	-	-
metallic	flat lens	1.9 mm	transparent red	<b>1.65.126.011/1300</b>	-	-
metallic	flat lens	1.9 mm	transparent yellow	<b>1.65.126.011/1400</b>	-	-
metallic	flat lens	1.9 mm	transparent green	<b>1.65.126.011/1500</b>	-	-
metallic	flat lens	1.9 mm	transparent blue	<b>1.65.126.011/1600</b>	-	-

Technical data see page 3 - 80

NEW

With Socket



## Signal lamps with lamp socket - BA 9s (MBC/MCC), 18.2 mm

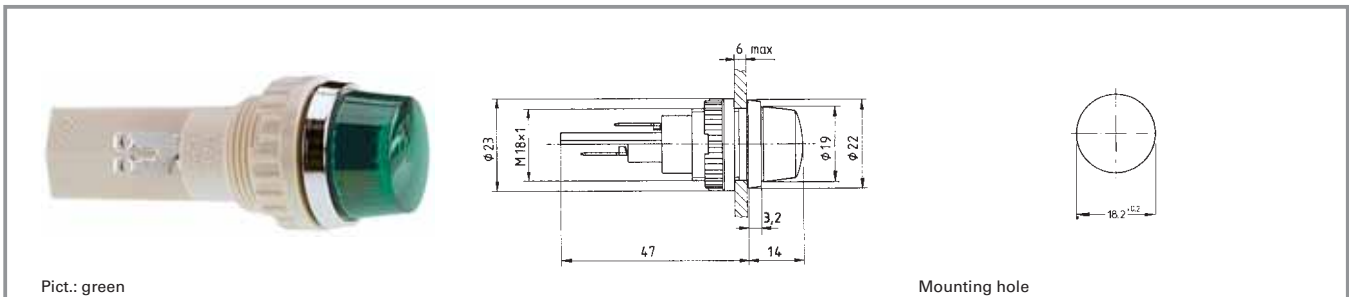

### Technical Data

#### General information

Form of lens	round
Colour of lens	see order block
Diameter of collar	22 mm

#### Electrical characteristics

Voltage limit max.	250 V
Power limit max.	2 W

#### Dimensions

Overall height	14 mm
Mounting depth	47 mm
Mounting hole	18.2 mm

#### Other specifications

Degree of protection from front side	IP65
Weight	22 g

#### Mechanical design

Mounting	ring nut
Terminals	solder/quick connector 6.3x0.8 / 2x 2.8x0.8mm
Lamp socket	BA 9 s
Lamp	filament lamp

### Approvals



VDE 0710

With Socket

### Typical accessories Signal lamps with lamp socket - BA 9s (MBC/MCC), 18.2 mm

Description	Photo	Order no.	Additional accessories see page
Filament lamp, BA 9s base (MBC/MCC), 12 - 15 V		<b>1.90.060.132/0000</b>	5 - 7
Filament lamp, BA 9s base (MBC/MCC), 24 - 30 V		<b>1.90.060.133/0000</b>	5 - 7
Filament lamp, BA 9s base (MBC/MCC), 110 - 130 V		<b>1.90.060.137/0000</b>	5 - 7

## Typical accessories Signal lamps with lamp socket - BA 9s (MBC/MCC), 18.2 mm

Description	Photo	Order no.	Additional accessories see page
Protective sleeve for terminals made of Buna N (NBR)		<b>5.52.011.027/0100</b>	

## Signal lamps with lamp socket - BA 9s (MBC/MCC), 18.2 mm, round lens

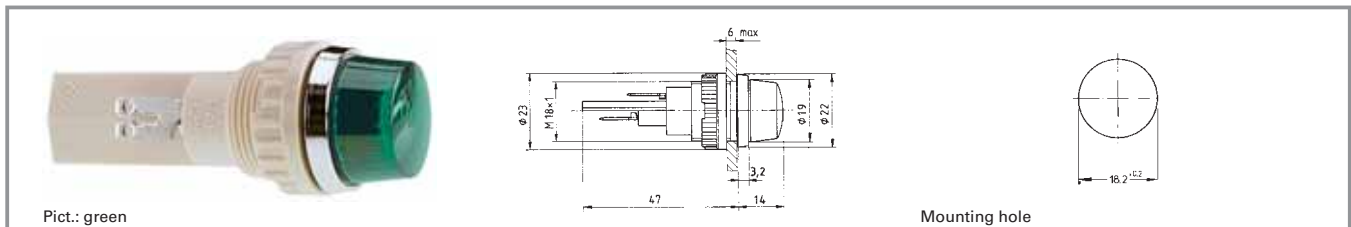

Voltage limit max.	Power limit max.	Lamp	Colour of lens	Order no. complete	Order no. single parts	
					Housing	Lens
250 V	2 W	filament lamp	transparent colourless	<b>1.63.018.001/1002</b>	1.63.018.091/0000	5.49.205.018/1002
250 V	2 W	filament lamp	transparent red	<b>1.63.018.001/1301</b>	1.63.018.091/0000	5.49.205.018/1301
250 V	2 W	filament lamp	transparent yellow	<b>1.63.018.001/1402</b>	1.63.018.091/0000	5.49.205.018/1402
250 V	2 W	filament lamp	transparent green	<b>1.63.018.001/1502</b>	1.63.018.091/0000	5.49.205.018/1502

Technical data see page 3 - 84

Please order luminous elements separately. When ordering as single parts, please add 1 x sealing ring 5.30.120.009/0100 for each signal lamp to your order.

3

With Socket

## Signal lamps with lamp socket - E 14, 22.3 mm

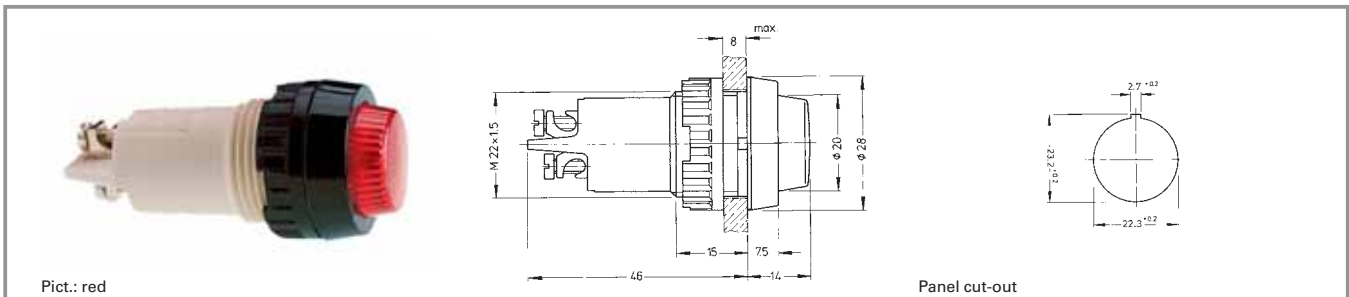

### Technical Data

#### General information

Form of lens	round
Colour of lens	see order block
Diameter of collar	28 mm

#### Electrical characteristics

Voltage limit max.	250 V
Power limit max.	2 W

#### Dimensions

Overall height	14 mm
Mounting depth	46 mm
Mounting hole	22.3 mm

#### Other specifications

Degree of protection from front side	see order block
Weight	21 g

#### Mechanical design

Mounting	ring nut
Terminals	see order block
Lamp socket	E 14
Lamp	filament lamp

### Approvals



VDET 85°

With  
Socket

### Typical accessories Signal lamps with lamp socket - E 14, 22.3 mm

Description	Photo	Order no.	Additional accessories see page
Filament lamp, E 14 base, 24 - 30 V		<b>1.90.020.033/0000</b>	5 - 10
Sealing ring for IP65		5.30.075.010/0100	5 - 24
Protection against contact to VBG 4		5.50.240.063/0209	5 - 25
Protective sleeve for terminals made of Buna N (NBR)		<b>5.52.011.029/0100</b>	

## Typical accessories Signal lamps with lamp socket - E 14, 22.3 mm

Description	Photo	Order no.	Additional accessories see page
Fixing spanner M 20, M 22, for ring nut		<b>5.58.002.018/0105</b>	5 - 21

## Signal lamps with lamp socket - E 14, IP40, 22.3 mm

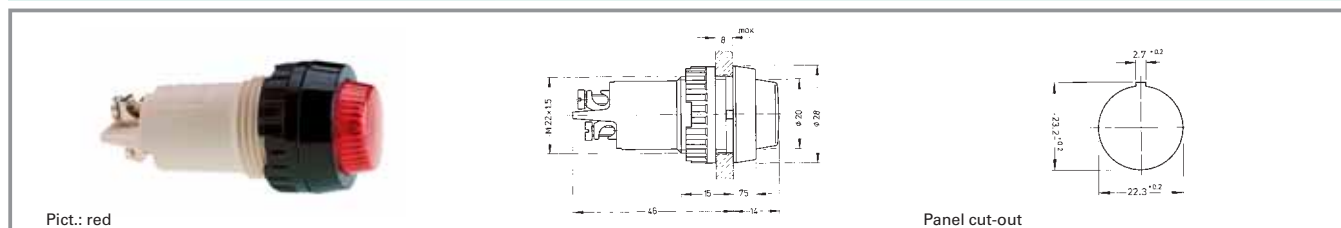

Voltage limit max.	Degree of protection from front side	Terminals	Colour of lens	Order no. complete	Order no. single parts	
					Housing	Lens
250 V	IP40	screw terminals brass nickel-plated	transparent colourless	1.61.012.011/1002	1.61.012.099/0000	5.00.350.726/1002
250 V	IP40	screw terminals brass nickel-plated	transparent red	1.61.012.011/1301	1.61.012.099/0000	5.00.350.726/1301
250 V	IP40	screw terminals brass nickel-plated	transparent yellow	1.61.012.011/1402	1.61.012.099/0000	5.00.350.726/1402
250 V	IP40	screw terminals brass nickel-plated	transparent green	1.61.012.011/1502	1.61.012.099/0000	5.00.350.726/1502

Technical data see page 3 - 86

## Signal lamps with lamp socket - E 14, 22.3 mm, screw-on lens, IP40

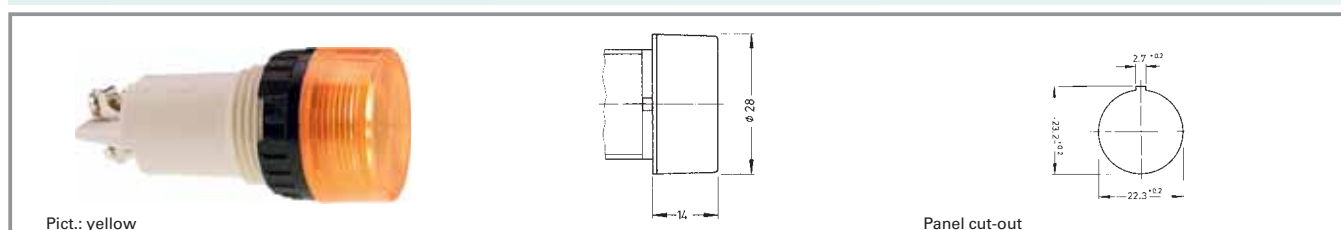

Voltage limit max.	Degree of protection from front side	Terminals	Colour of lens	Order no. complete	Order no. single parts	
					Housing	Lens
250 V	IP40	screw terminals brass nickel-plated	transparent colourless	1.61.012.061/1002	1.61.012.099/0000	5.49.229.006/1002
250 V	IP40	screw terminals brass nickel-plated	transparent red	1.61.012.061/1301	1.61.012.099/0000	5.49.229.006/1301
250 V	IP40	screw terminals brass nickel-plated	transparent yellow	1.61.012.061/1402	1.61.012.099/0000	5.49.229.006/1402
250 V	IP40	screw terminals brass nickel-plated	transparent green	1.61.012.061/1502	1.61.012.099/0000	5.49.229.006/1502

Technical data see page 3 - 86

3

With Socket

## RAFIX 22 QR - Signal indicator



Pict.: yellow

Panel cut-out to IEC 60947-5-1

### Technical Data

#### General information

Form of lens	see order block
Colour of lens	see order block
Legend insert accomodation	see order block
Form of collar	see order block

#### Dimensions

Dimensions of collar	see order block
Overall height	see order block
Mounting depth	56.4 mm
Mounting hole	Ø 22.3 mm
Mounting grid	50 x 30 mm

#### Mechanical design

Mounting	ring nut
Illuminability	yes

#### Electrical characteristics

Protection class	-
------------------	---

#### Other specifications

Degree of protection from front side	IP65
Ambient temp. operating min.	-25 °C
Ambient temp. operating max.	+70 °C
Storage temperature min.	-40 °C
Storage temperature max.	+80 °C
Environmental resistance	acc. to IEC 60068-2 -14, -30, -33 and -78

### Approvals



IEC 61058



UL 508, C22.2 No.  
14-M91



2004 Steel Vessel  
Rules



Rules for the  
Classification of  
Steel Ships



Classification of  
Ships....Rules



Marine, offshore  
and industrial use



German Lloyds  
type approval



With  
Socket

### Typical accessories RAFIX 22 QR - Signal indicator

Bezeichnung	Foto	Bestell-Nr.	Seitenverweise/ Weiteres Zubehör
RAFIX 22 QR contact block AS-I, standard, white LED		1.20.129.121/0000	2 - 157
RAFIX 22 QR - Lamp socket assembly, screw terminals, with coupling		<b>1.71.213.001/0000</b>	2 - 162
RAFIX 22 QR - Lamp socket assembly, screw terminals, with coupling, diode and series resistor 130 V		<b>1.71.213.004/0000</b>	2 - 162



## Typical accessories RAFIX 22 QR - Signal indicator

Bezeichnung	Foto	Bestell-Nr.	Seitenverweise/ Weiteres Zubehör
RAFIX 22 QR - Lamp socket assembly, spring-type terminals, with coupling		<b>1.71.214.001/0000</b>	2 - 162
Fixing spanner for ring nut and front ring		<b>5.05.800.062/0000</b>	5 - 21
Legend insert without legend, use only in combination with transparent lenses		<b>5.70.803.000/2000</b>	

## RAFIX 22 QR - Signal indicator, flat, round collar, for legend inserts

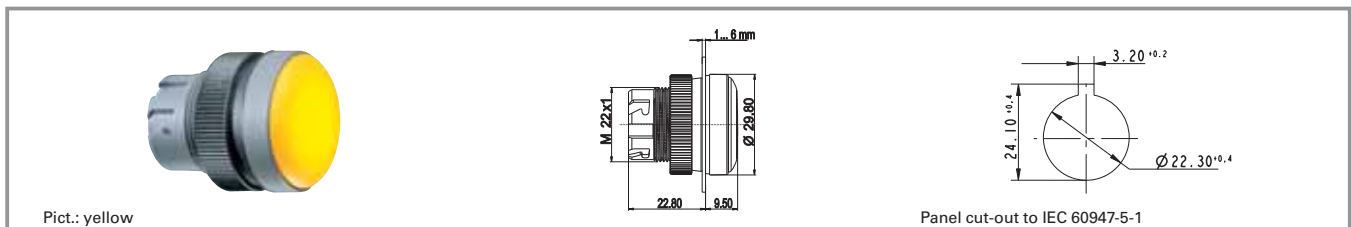

Colour of lens	Form of collar	Order no.
transparent colourless	round	<b>1.74.505.501/1000</b>
transparent red	round	<b>1.74.505.501/1300</b>
transparent yellow	round	<b>1.74.505.501/1400</b>
transparent green	round	<b>1.74.505.501/1500</b>
transparent blue	round	<b>1.74.505.501/1600</b>

Technical data see page 3 - 88

### Accessoires:

Legend insert without legend, use only in combination with transparent lenses.: **5.70.803.000/2000**

3

With  
Socket

**NEW**

## RAFIX 22 QR - Signal indicator, high, round collar

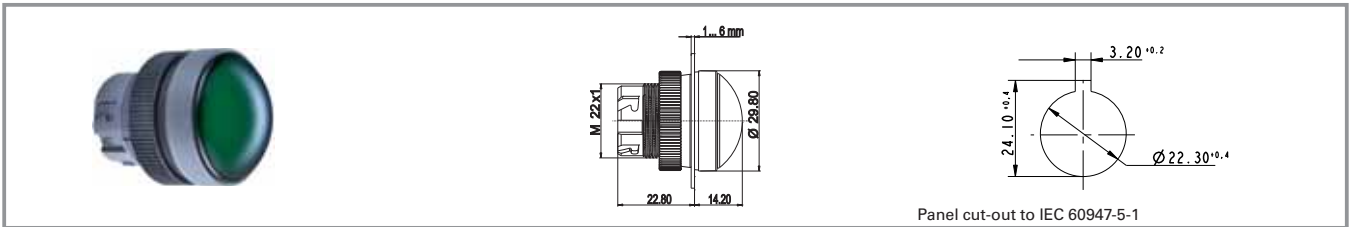

Colour of lens	Form of collar	Order no.
transparent colourless	round	<b>1.74.505.511/1000</b>
transparent red	round	<b>1.74.505.511/1300</b>
transparent yellow	round	<b>1.74.505.511/1400</b>
transparent green	round	<b>1.74.505.511/1500</b>
transparent blue	round	<b>1.74.505.511/1600</b>

Technical data see page 3 - 88

Legend insert on request

**3**

## RAFIX 22 QR - Signal indicator, flat, square collar, for legend inserts

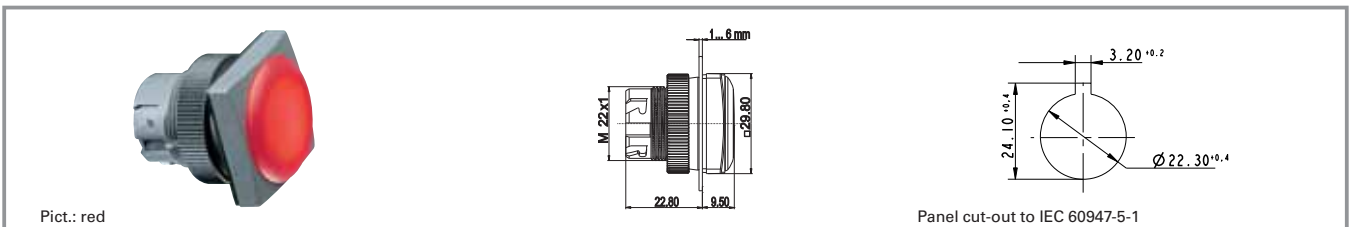

Colour of lens	Form of collar	Order no.
transparent colourless	square	<b>1.74.505.551/1000</b>
transparent red	square	<b>1.74.505.551/1300</b>
transparent yellow	square	<b>1.74.505.551/1400</b>
transparent green	square	<b>1.74.505.551/1500</b>
transparent blue	square	<b>1.74.505.551/1600</b>

Technical data see page 3 - 88

**Accessoires:**

Legend insert without legend, use only in combination with transparent lenses.: **5.70.803.000/2000**

**With Socket**

## RAFIX 22 QR - Signal indicator, high, square collar

**NEW**

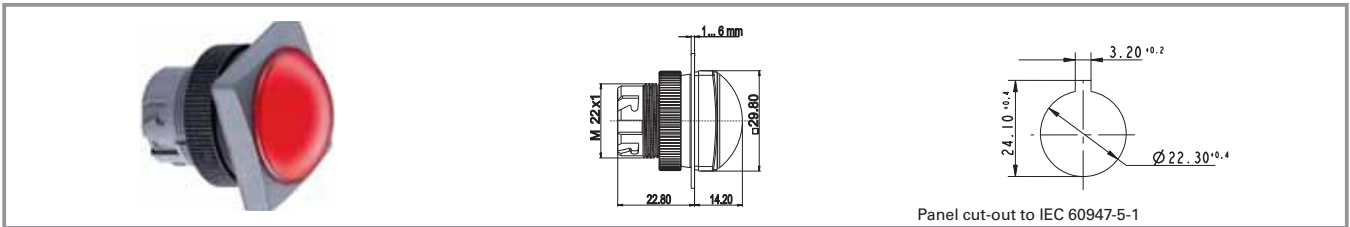

Colour of lens	Form of collar	Order no.
transparent colourless	square	<b>1.74.505.561/1000</b>
transparent colourless	square	<b>1.74.505.561/1600</b>
transparent red	square	<b>1.74.505.561/1300</b>
transparent yellow	square	<b>1.74.505.561/1400</b>
transparent green	square	<b>1.74.505.561/1500</b>

Technical data see page 3 - 88

Legend insert on request

**3**

**With  
Socket**

## RAFIX 22 FS - Signal indicator



### Technical Data

#### General information

Form of lens	see order block
Colour of lens	see order block
Form of collar	see order block

#### Dimensions

Length of collar	see order block
Overall height	see order block
Mounting depth	see order block
Mounting hole	22.3 mm
Key grid	30 x 30 mm

#### Mechanical design

Mounting	ring nut
Illuminability	yes

#### Mechanical characteristics

Robustness min.	100 N
-----------------	-------

#### Other specifications

Degree of protection from front side	IP65
Ambient temp. operating min.	-25 °C
Ambient temp. operating max.	+70 °C
Approvals	see order block
Storage temperature min.	-40 °C
Storage temperature max.	+80 °C
Environmental resistance	acc. to IEC 60068-2 -14, -30, -33 and -78
Salt spray	IEC 600 68-2-11

### Approvals



IEC 60947-5-x,  
60904, 60073



UL 508, C22.2 No.  
14-M91

With  
Socket

### Typical accessories RAFIX 22 FS - Signal indicator

Description	Photo	Order no.	Additional accessories see page
3 mm LED superbright red		<b>1.90.690.269/0000</b>	2 - 237, 5 - 17
Fixing spanner for ring nut and front ring		<b>5.05.800.062/0000</b>	5 - 21
LED base for signal indicators, height 5 mm		<b>5.30.109.020/0756</b>	2 - 236
RAFIX 22 FS - Socket for LED-Clip, quick-connect terminals		<b>5.55.104.419/0700</b>	2 - 235

## RAFIX 22 FS - Signal indicator, round collar, flat

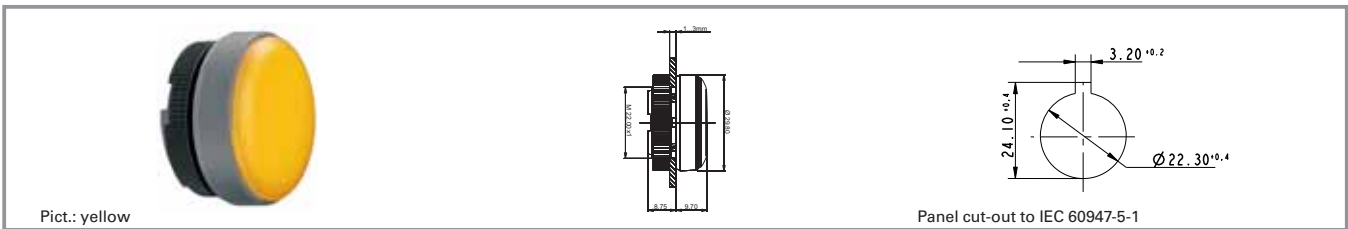

Form of collar	Colour of lens	Order no.
round	transparent colourless	<b>1.74.506.001/1000</b>
round	transparent red	<b>1.74.506.001/1300</b>
round	transparent yellow	<b>1.74.506.001/1400</b>
round	transparent green	<b>1.74.506.001/1500</b>
round	transparent blue	<b>1.74.506.001/1600</b>

Technical data see page 3 - 92

Legending on request

## RAFIX 22 FS - Signal indicator, round collar, high

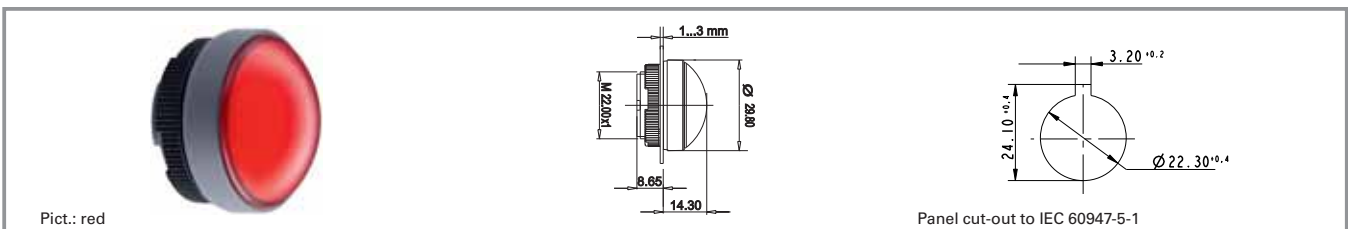

Form of collar	Colour of lens	Order no.
round	transparent colourless	1.74.506.011/1000
round	transparent red	1.74.506.011/1300
round	transparent yellow	1.74.506.011/1400
round	transparent green	1.74.506.011/1500
round	transparent blue	1.74.506.011/1600

Technical data see page 3 - 92

Legending on request

3

NEW

With Socket

## RAFIX 22 FS - Signal indicator, square collar, flat

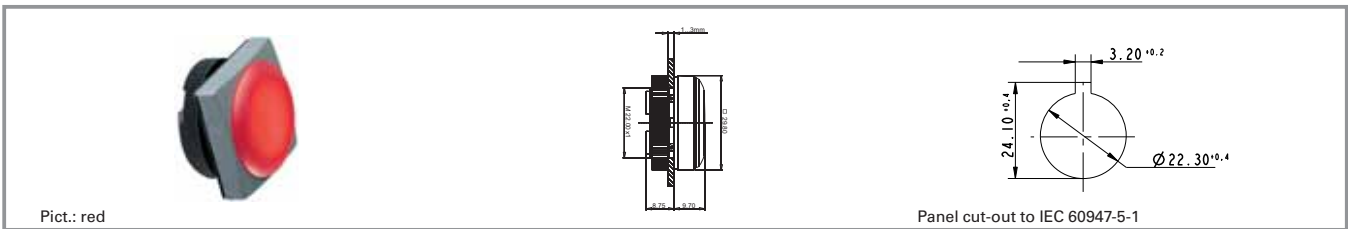

Form of collar	Colour of lens	Order no.
square	transparent colourless	<b>1.74.506.051/1000</b>
square	transparent red	<b>1.74.506.051/1300</b>
square	transparent yellow	<b>1.74.506.051/1400</b>
square	transparent green	<b>1.74.506.051/1500</b>
square	transparent blue	<b>1.74.506.051/1600</b>

Technical data see page 3 - 92

Legending on request

3

## RAFIX 22 FS - Signal indicator, round collar, high

NEW

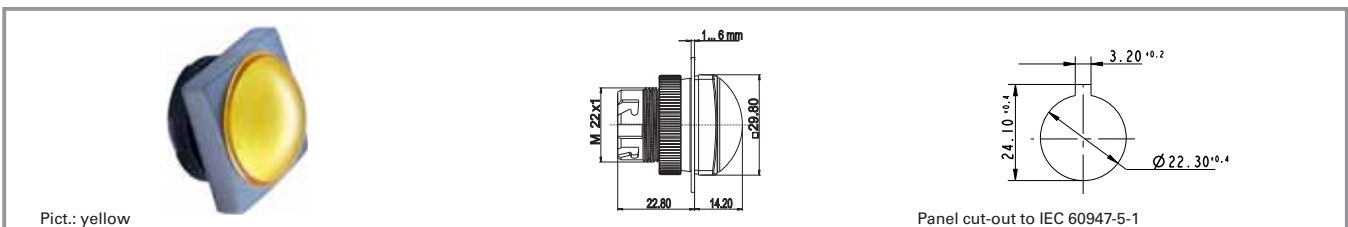

Form of collar	Colour of lens	Order no.
square	transparent colourless	1.74.506.061/1000
square	transparent red	1.74.506.061/1300
square	transparent yellow	1.74.506.061/1400
square	transparent green	1.74.506.061/1500
square	transparent blue	1.74.506.061/1600

Technical data see page 3 - 92

Legending on request

With Socket



## Signal lamps with lamp socket - E 14, 30.5 mm



### Technical Data

#### General information

Form of lens	round
Colour of lens	see order block
Diameter of collar	36 mm

#### Dimensions

Overall height	see order block
Mounting depth	58 mm
Mounting hole	30,5 <sup>+0,5</sup> mm

#### Mechanical design

Mounting	ring nut
Terminals	quick connector for 2 x 2.8 x 0.8 mm
Lamp socket	E 14
Lamp	filament lamp

#### Electrical characteristics

Voltage limit max.	250 V
Power limit max.	5 W

#### Other specifications

Degree of protection from front side	see order block
Weight	40 g

### Typical accessories Signal lamps with lamp socket - E 14, 30.5 mm

With  
Socket

Description	Photo	Order no.	Additional accessories see page
Filament lamp, E 14 base, 24 - 30 V		<b>1.90.020.033/0000</b>	5 - 10
Filament lamp, E 14 base, 24 V		<b>1.90.020.053/0000</b>	5 - 11
Filament lamp, E 14 base, 220 - 260 V		<b>1.90.020.061/0000</b>	5 - 11
Filament lamp, E 14 base, 24 - 30 V		<b>1.90.020.105/0000</b>	5 - 11
Filament lamp, E 14 base, 220 - 260 V		<b>1.90.020.115/0000</b>	5 - 11
Protection against contact to VBG 5		5.50.240.065/0200	5 - 25
Protective sleeve for terminals		<b>5.52.011.031/0100</b>	
Fixing spanner M 25, M 30		<b>5.58.002.020/0105</b>	5 - 21

The filament lamps 1.90.020.105/0000 and 1.20.090.115/0000 can only be used in combination with the lens form 2. Because of their height, they support the best illumination of this lens shape.



## Signal lamps with lamp socket - E 14, IP40, 30.5 mm

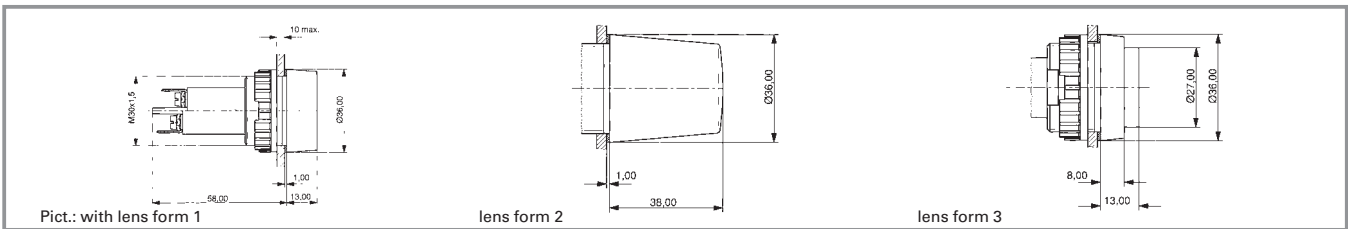

Voltage limit max.	Power limit max.	Degree of protection from front side	Order no. without lens	Note
250 V	5 W	IP40	1.61.021.099/0000	Please include the desired lens in your order.

Technical data see page 3 - 96

### Lenses:

- Screw-on lens, form 3, transparent colourless: 5.00.350.013/1002
- Screw-on lens, form 3, transparent red: 5.00.350.013/1301
- Screw-on lens, form 3, transparent yellow: 5.00.350.013/1402
- Screw-on lens, form 3, transparent green: 5.00.350.013/1502
- Screw-on lens, form 1, transparent colourless: 5.49.233.005/1002
- Screw-on lens, form 1, transparent red: 5.49.233.005/1301
- Screw-on lens, form 1, transparent yellow: 5.49.233.005/1402
- Screw-on lens, form 1, transparent green: 5.49.233.005/1502
- Screw-on lens, form 2, transparent colourless: 5.49.233.008/1002
- Screw-on lens, form 2, transparent red: 5.49.233.008/1301
- Screw-on lens, form 2, transparent yellow: 5.49.233.008/1402
- Screw-on lens, form 2, transparent green: 5.49.233.008/1502

Single-wire screw terminal with clamp: 2 x 0.75 to 2.5 mm<sup>2</sup>, stranded core with wire end sleeve: 2 x 0.75 to 1.5 mm<sup>2</sup>, quick-connect terminal suitable for 2 x 2.8 x 0.8 tin-plated for soldering.

## Signal lamps with lamp socket - BA 15d, 30.5 mm



### Technical Data

#### General information

Form of lens	round
Colour of lens	see order block
Diameter of collar	36 mm

#### Dimensions

Overall height	see order block
Mounting depth	58 mm
Mounting hole	30,5 <sup>+0,5</sup> mm

#### Mechanical design

Mounting	ring nut
Terminals	quick connector for 2 x 2.8 x 0.8 mm
Lamp socket	BA 15 d
Lamp	filament lamp

#### Electrical characteristics

Voltage limit max.	250 V
Power limit max.	5 W

#### Other specifications

Degree of protection from front side	see order block
Weight	40 g

### Typical accessories Signal lamps with lamp socket - BA 15d, 30.5 mm

Description	Photo	Order no.	Additional accessories see page
Filament lamp, BA 15d base, 12 - 15 V		<b>1.90.070.003/0000</b>	5 - 8
Filament lamp, BA 15d base, 24 - 30 V		<b>1.90.070.004/0000</b>	5 - 8
Filament lamp, BA 15d base, 24 V		<b>1.90.070.053/0000</b>	5 - 9
Filament lamp, BA 15d base, 220 - 260 V		1.90.070.061/0000	5 - 9
Filament lamp, BA 15d base, 24 - 30 V		<b>1.90.070.105/0000</b>	5 - 9
Protection against contact to VBG 5		5.50.240.065/0200	5 - 25
Protective sleeve for terminals		<b>5.52.011.031/0100</b>	
Fixing spanner M 25, M 30		<b>5.58.002.020/0105</b>	5 - 21

The filament lamps 1.90.070.105/0000 can only be used in combination with the lens form 2. Because of their height, they support the best illumination of this lens shape.

## Signal lamps with lamp socket - BA 15d, IP40, 30.5 mm

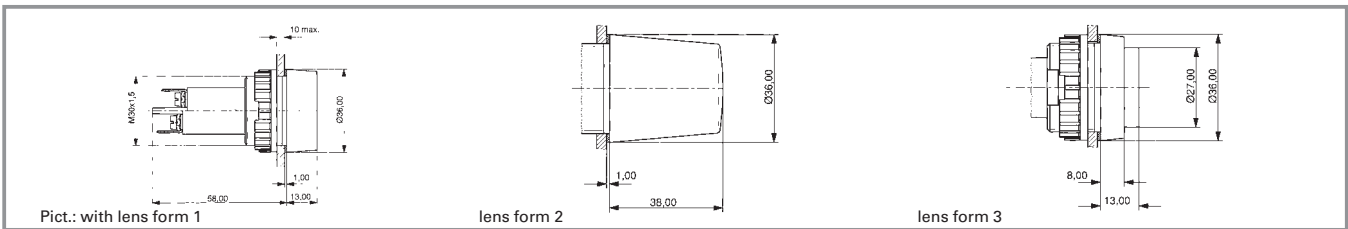

Voltage limit max.	Power limit max.	Degree of protection from front side	Colour of lens	Order no. without lens	Note
250 V	5 W	IP40	-	1.63.521.099/0000	Please include the desired lens in your order.

Technical data see page 3 - 98

### Lenses:

- Screw-on lens, form 3, transparent colourless: 5.00.350.013/1002
- Screw-on lens, form 3, transparent red: 5.00.350.013/1301
- Screw-on lens, form 3, transparent yellow: 5.00.350.013/1402
- Screw-on lens, form 3, transparent green: 5.00.350.013/1502
- Screw-on lens, form 1, transparent colourless: 5.49.233.005/1002
- Screw-on lens, form 1, transparent red: 5.49.233.005/1301
- Screw-on lens, form 1, transparent yellow: 5.49.233.005/1402
- Screw-on lens, form 1, transparent green: 5.49.233.005/1502
- Screw-on lens, form 2, transparent colourless: 5.49.233.008/1002
- Screw-on lens, form 2, transparent red: 5.49.233.008/1301
- Screw-on lens, form 2, transparent yellow: 5.49.233.008/1402
- Screw-on lens, form 2, transparent green: 5.49.233.008/1502

Single-wire screw terminal with clamp: 2 x 0.75 to 2.5 mm<sup>2</sup>, stranded core with wire end sleeve: 2 x 0.75 to 1.5 mm<sup>2</sup>, quick-connect terminal suitable for 6.8 x 0.8 mm / 2 x 2.8 x 0.8 mm, tin-plated for soldering.





## General Data

Sockets to accommodate filament lamps and LEDs with bases.

## Content

<b>Panel mounting sockets - W 2 x 4.6d</b>	<b>3 - 102</b>
Panel mounting sockets - W 2 x 4.6d	3 - 103
<b>Panel mounting sockets - Tubular lamp holders</b>	<b>3 - 104</b>
Panel mounting sockets - Tubular lamp holders	3 - 104
<b>Panel mounting sockets - BA 15d</b>	<b>3 - 106</b>
Panel mounting sockets - BA 15d	3 - 106

## Panel mounting sockets - W 2 x 4.6d



### Technical Data

#### Mechanical design

Mounting see order block  
Terminals see order block  
Lamp socket W 2 x 4.6d

#### Electrical characteristics

Limit values 35 V/1.5 W

#### Other specifications

Weight 1 g

3

### Typical accessories Panel mounting sockets - W 2 x 4.6d

Description	Photo	Order no.	Additional accessories see page
Filament lamp, W 2 x 4.6d base, 24 - 30 V		<b>1.90.120.005/0000</b>	5 - 4
Filament lamp, W 2 x 4.6d base, 60 V		<b>1.90.120.009/0000</b>	5 - 4
Filament lamp, W 2 x 4.6d base, 48 V		<b>1.90.120.010/0000</b>	5 - 4
Filament lamp, W 2 x 4.6d base, 24 V		<b>1.90.120.011/0000</b>	5 - 4
LED W 2 x 4.6d superbright, red, 24 V		<b>1.90.690.361/0000</b>	5 - 14
LED W 2 x 4.6d superbright, green, 24 V		<b>1.90.690.362/0000</b>	5 - 14
LED W 2 x 4.6d superbright, yellow, 24 V		<b>1.90.690.363/0000</b>	5 - 14
LED W 2 x 4.6d superbright, blue, 24 V		<b>1.90.690.364/0000</b>	5 - 14
LED W 2 x 4.6d superbright, white, 24 V		<b>1.90.690.365/0000</b>	5 - 14

Socket

## Panel mounting sockets - W 2 x 4.6d

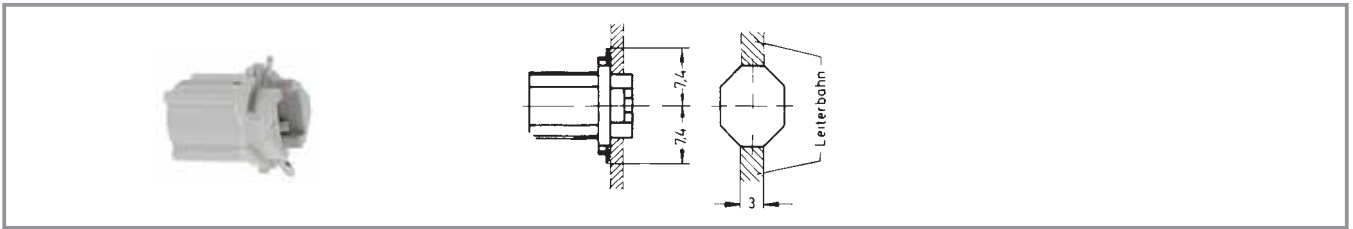

Lamp socket	Limit values	Terminals	Mounting	Order no.
W 2 x 4.6d	35 V/1.5 W	2 spring contacts	90° turn	1.72.401.021/0000

Technical data see page 3 - 102

**Panel mounting sockets - Tubular lamp holders**



**Technical Data**

<b>Mechanical design</b>		<b>Electrical characteristics</b>	
Mounting	cut-out in housing	Limit values	2 A / 35 V
Terminals	screw terminals	<b>Other specifications</b>	
Lamp socket	S 8.5	Weight	11 g
Insulation group	according to VDE 0110 b/DIN 57110 b		

3

**Typical accessories Panel mounting sockets - Tubular lamp holders**

Description	Photo	Order no.	Additional accessories see page
Filament lamp, S 8.5 base, 24 V, shape L		<b>1.90.111.003/0000</b>	5 - 12
Filament lamp, S 8.5 base, 24 V, shape K		1.90.111.103/0000	5 - 12

**Panel mounting sockets - Tubular lamp holders**

Socket

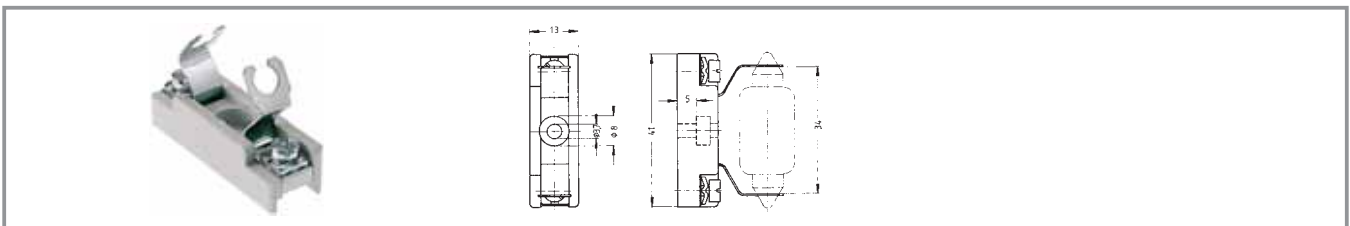

Lamp socket	Limit values	Terminals	Mounting	Order no.
S 8.5	2 A/35 V	screw terminals	cut-out in housing	<b>1.02.570.021/0000</b>





## Panel mounting sockets - BA 15d



### Technical Data

#### Mechanical design

Mounting see order block  
 Terminals see order block  
 Lamp socket BA 15 d

#### Electrical characteristics

Limit values see order block

#### Other specifications

Weight see order block

3

#### Approvals



VDET 135°, max. 4 W / 2 A

## Panel mounting sockets - BA 15d

Socket

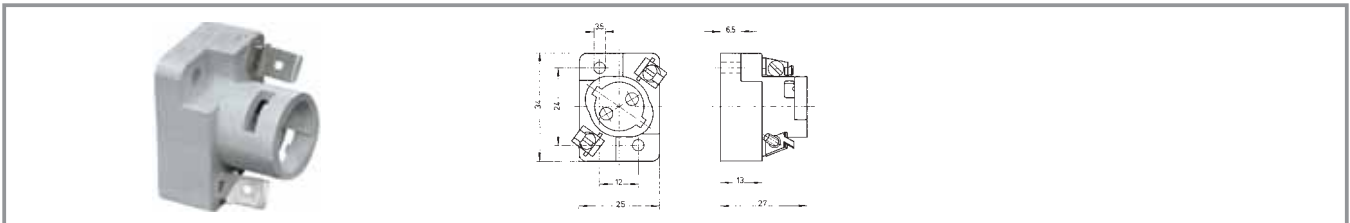

Lamp socket	Limit values	Terminals	Mounting	Order no.
BA 15 d	250 V/4 W	quick connector	cut-out in housing	1.02.582.002/0000