

2017

PRODUCT CATALOG &
APPLICATION GUIDE

PLATO®

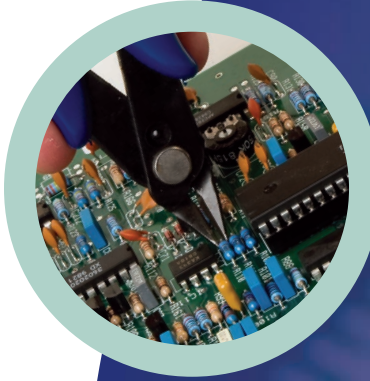

Lead Cutters

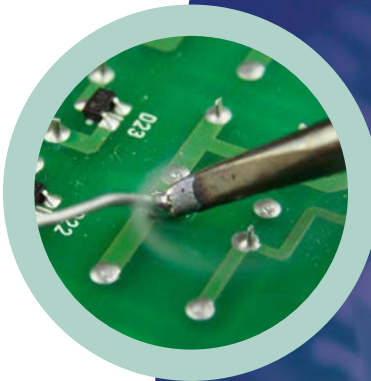

Soldering Tips



Soldering Accessories



Sponges

LEAD CUTTERS

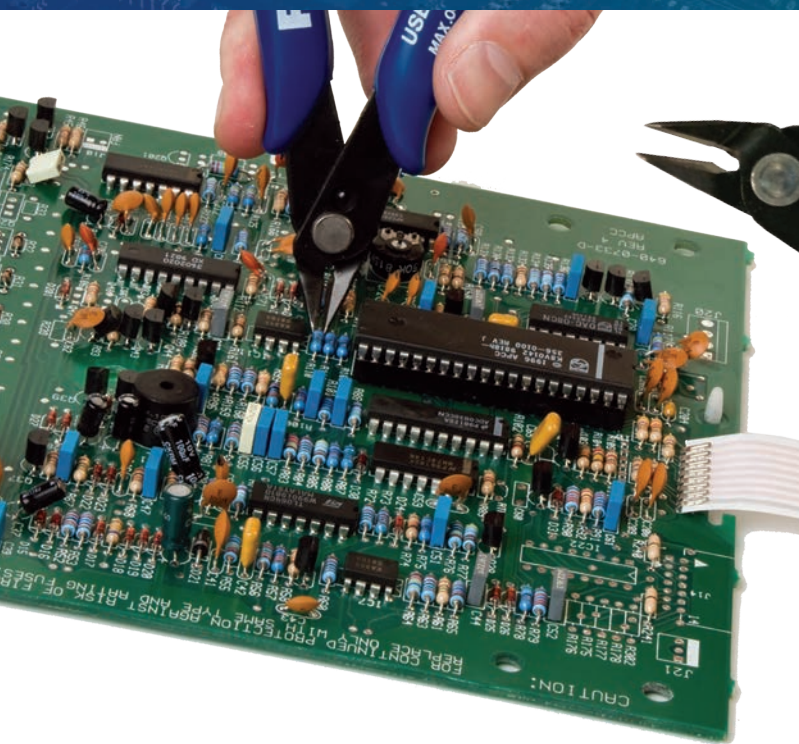

Our best-selling cutter!

170 • 175

PLATOSHEAR GENERAL PURPOSE LEAD CUTTER

Precise, reliable cutting action at an economical price. Thin profile handle and light weight design is ideal for smaller hands.

- Cut up to 18 AWG copper wire (.04"/1mm)
- Economical, disposable cutter
- Thin blade profile for trimming in tight areas
- Ergonomic handle design
- Spring-back action

170 1 cutter, 10/case

175 1 cutter w/safety guard, 10/case



LEAD CUTTERS

Plato cutters give you the precision of a high-end tool, but at a disposable cutter price. Assemblers love the effortless shearing action, comfort, and safety. Plato cutters use the shear cutting method, which requires 50% less operator effort and extends cutting life.

The thin profile design is perfect for hard-to-reach areas in electronic assembly. Handles are cushioned for comfort all day, and automatically spring back to their original position after each use.

170S

PLATOSHEAR S HEAVY GAUGE LEAD CUTTER

Blades designed for higher gauge leads and wire, and for greater durability.

- Cut up to 15 AWG copper wire (.06"/1.5mm)
- Long-life blade design
- Ergonomic handle design
- Spring-back action

170S 1 cutter,
10/case



Cuts 50%
thicker leads!

170SD

PLATO SHEAR STATIC DISSIPATIVE LEAD CUTTER



Permanently static dissipative grips meet DODSTD-1686 and MIL-B-81705, type 2.

- Cut up to 18 AWG copper wire (.04"/1mm)
- Thin blade profile for trimming in tight areas
- ESD safe handle
- Spring-back action

170SD 1 cutter, 10/case



OPTIONAL SAFETY GUARD

175 and 175LX cutters come with a lead catcher, which holds onto a trimmed lead until the shear is opened. This prevents leads from flying off, which can lead to eye injury or contaminate the assembly.

Safety Guard



170LX – ADVANCED DESIGN FOR DAY-LONG COMFORT



- Comfortable, Ergonomic design
- ESD safe to protect sensitive components
- Responsive spring-back action for quick, comfortable cutting of multiple leads
- Thin profile design to reach tight areas in electronics assembly
- Available with a permanently attached safety guard to reduce the risk of lead fly-off (175LX)



170LX • 175LX

LEAD CUTTER

ERGONOMIC, ESD SAFE LEAD CUTTER

The 170LX and the 175LX are a remarkable advancement in cutter design. Carefully crafted precision cutting blades combine seamlessly with curved, palm shaped, handles to deliver effortless lead cutting and user comfort.

170LX 1 cutter, 10/case

175LX 1 cutter w/safety guard, 10/case



Shearing action of blades produces a clean precise cut with less effort.

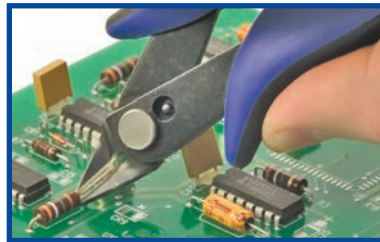

170LX is ESD safe to protect components from static discharge.



Comfortable grip reduces operator fatigue and increases productivity.

1755

PLATO BIG SHEAR

HEAVY DUTY CUTTER

Cuts round and flat cable, co-ax, nickel, Kovar and other wire with a clean shearing cut that reduces cable cut-end distortion. Lightweight design significantly reduces operator fatigue.

- For heavy gauge wire
- Cushioned rubber handles
- Spring-back action

1755 1 cutter, 10/case



BOTTLES & SOLDERING ACCESSORIES



FD-2 • FD-21 • SD-01 • SD-02 NEEDLE FLUX DISPENSERS

Needle bottles are ideal for precisely controlled flux applications. Two different needle sizes are available: 0.25mm for low viscosity no-clean and aqueous fluxes, and 0.50mm for higher viscosity rosin-based fluxes.

Each bottle is available in standard plastic or with optional ESD-safe cover. Plato ESD-safe bottles are surrounded by permanently static dissipative sleeves that stay out of contact with flux and other liquids. This prevents conductive "hot spots" on the surface of the bottle.

- Dispense precise amount of flux without dripping, spilling, or waste
- Unique, no leak design

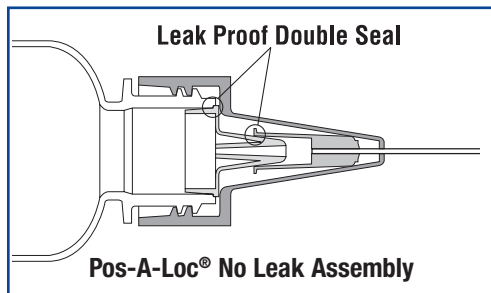

ESD-Safe Bottles:

- Protects voltage sensitive devices from static discharge
- Meets ANSI J-STD-001B
- Meets the requirements of DOD-STD-1686 for containers
- Physical characteristics comply with MIL-B-81705, Type 2

**0.25mm needle for
No-Clean & Aqueous Fluxes**

- FD-21** 1 bottle
SF-01 1 bottle, ESD-safe

**0.50mm needle for
Rosin-based Fluxes**

- FD-2** 1 bottle
SF-02 1 bottle, ESD-safe

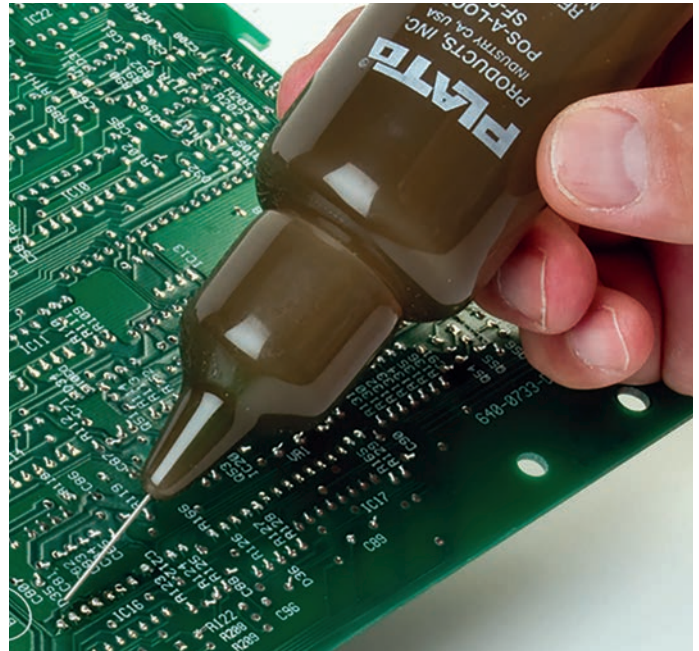

CS-50 BRASS WATERLESS TIP CLEANER



- Works with all popular soldering stations
- Cleans quickly without water
- Eliminates thermal shock of wet sponge

CS-50 1 Brass Tip Cleaner pad (30g), 6 pads/bag

Holder not included.

TT-95 TIP TINNER/TIP CLEANER

Plato's Tip Cleaner provides fast, efficient cleaning and re-tinning of highly oxidized soldering iron tips. This thermally-stable compound is lead-free, environmentally safe, and in an ESD-safe container. Tip Cleaner brings oxidized tips back to life, which improves soldering speed. Roll a hot soldering tip in the Tip Cleaner for a few seconds until the bright tinning surrounds the end of the tip.

- Extends tip life
- Lead-free
- Easy to use

TT-95 1 – 20g container, 10 per case





REPLACEMENT SPONGES

Manufactured with pure cellulose (a wood derivative) which has the ability to absorb many times its weight in water. Also resistant to abrasion and tearing when wiping tips. Meets ANSI J-STD-001B for low sulphur content and fine porosity.

Special design features:

- Hole - Increases wiping surface.
- Slitted - Prevents throwing excess solder.

CS-17 • CS-17/625

PLATO CUT-TO-FIT SHEET

For difficult to find sponge sizes or special applications, Plato offers full sheets of sponge material that can be trimmed to exact size.

CS-17 — 1 sheet,
8.5" x 17" x 1" thick
(216mm x 432mm
x 25mm thick)

CS-17/625
Thinner Economy
Sponge, 1 sheet,
8.5" x 17" x 0.625" thick
(216mm x 432mm x 16mm thick)

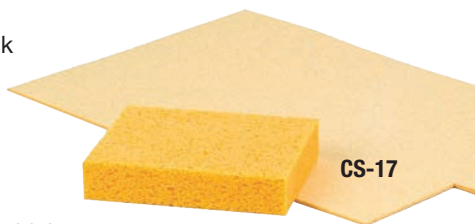

CS-44 • CS-888S • CS-888H

HAKKO COMPATIBLE REPLACEMENT SPONGES

CS-44
10 sponges/pack, 2.7" x 2.7" x 1" thick
(69mm x 69mm x 25mm thick)
Comparable to Hakko 609-0229, A1042



CS-888S
10 sponges/bag, 2.36" dia x 2" x 0.625" thick
(60mm dia x 51mm x 17mm thick)
Comparable to Hakko A1559



CS-888H
10 sponges/bag,
2.36" dia x 2" x 0.625" thick
(60mm dia x 51mm x 17mm thick)
Fits Hakko FX-888, FX-888D
Comparable to Hakko A1559



CS-47

METCAL & UNGAR COMPATIBLE REPLACEMENT SPONGES

CS-47 — 10 sponges/pack,
2.1" x 3.2" x 1" thick
(53mm x 81mm x 25mm thick)
Comparable to Metcal STSS-YS3,
AC-YS3, ACY10, Ungar 455, UTC234



Hole design

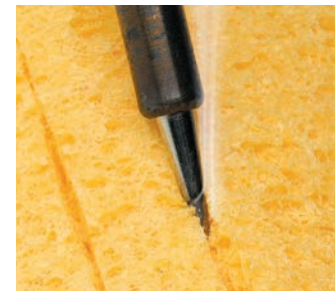

Slitted design

C-1 • CS-14/14M • CS-33 • CS-44

WELLER & PACE COMPATIBLE REPLACEMENT SPONGES

CS-1

10 sponges/pack,
1.5" x 2.12" x 1" thick (38mm x 54mm x 25mm thick)
Comparable to Weller SP-60, Pace 4021-005

CS-14

10 sponges/pack,
2.15" x 2.75" x 1" thick
(55mm x 70mm x 25mm thick)
Comparable to Weller T52241999

CS-14M

10 sponges/pack,
2.15" x 2.75" x 1" thick
(55mm x 70mm x 25mm thick)
Comparable to Weller T52241999

CS-33

10 sponges/pack,
2.7" x 4.5" x 1" thick
(70mm x 114mm x 25mm thick)
Comparable to Weller EC205,
EC2000, EC2002

CS-44

10 sponges/pack,
2.7" x 2.7" x 1" thick
(69mm x 69mm x 25mm thick)
Comparable to Weller TC205

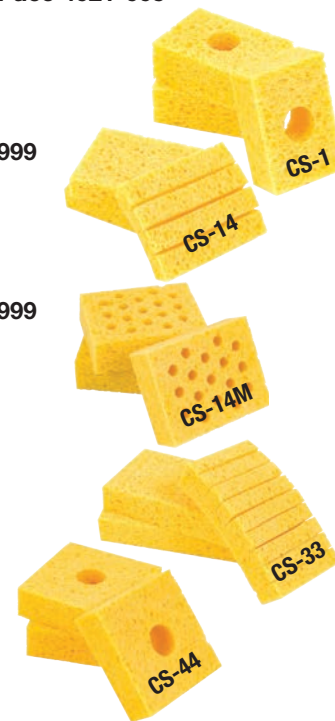

CS-9/625 • CS-36

HEXACON COMPATIBLE REPLACEMENT SPONGES

CS-9/625

10 sponges/pack,
3.5" x 4.5" x 0.625" thick
(89mm x 114mm x 16mm thick)
Comparable to Hexacon 8101,
8101C, 8121, 8121C

CS-36

10 sponges/pack,
2.24" x 3.5" x 1" thick
(57mm x 89mm x 25mm thick)
Comparable to Hexacon
8141, 8141C



PLATO®

YOUR ONE SOURCE FOR SOLDERING TIPS

Plato is one of the largest manufacturers of soldering tips in the world, producing tips to fit all of the most popular soldering stations.

LONG LIFE

Using a high quality Plato soldering tip increases soldering speed and decreases the total cost of manufacture. Higher temperatures and high tin content solders, common in lead-free soldering processes, place additional strain on soldering iron tips. The long life of a Plato soldering iron tip reduces tip changes, decreasing the total number of tips used and decreasing down time.

RAPID HEAT RECOVERY

Plato soldering tips are constructed from highly conductive premium grade copper to transmit heat to the work more quickly than other brands of soldering tips. Quick heat recovery enables more joints to be soldered per minute, reducing manufacturing time and costs.

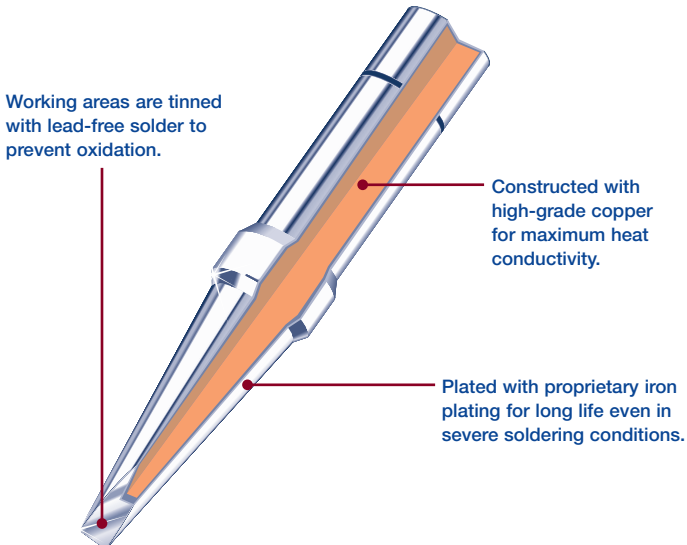

CHOOSING THE RIGHT SOLDERING TIP

Solder tip shapes should be chosen to allow the maximum wetted contact of the tip point with the leads and contacts to be soldered. Solder tip should be similar to the size of the contact area.

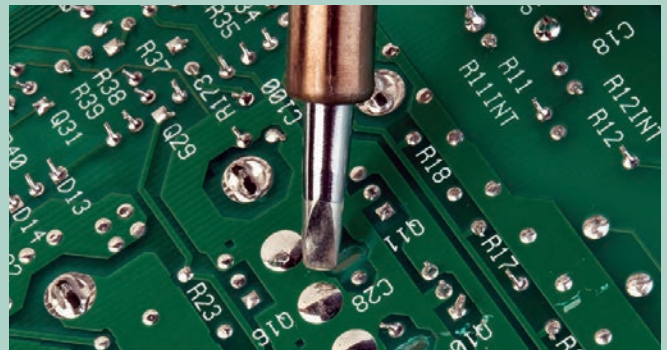

Solder tips are available in a variety of shapes to better match the contact area and meet special application requirements.

Pointed or Conical



Blade or Knife



Chisel or Screwdriver



Bevel



NEW!



JAPAN UNIX COMPATIBLE SOLDERING TIPS

- Plating engineered for long tip life
- 1-piece design for faster heat throughput
- Custom tip development at reasonable minimums

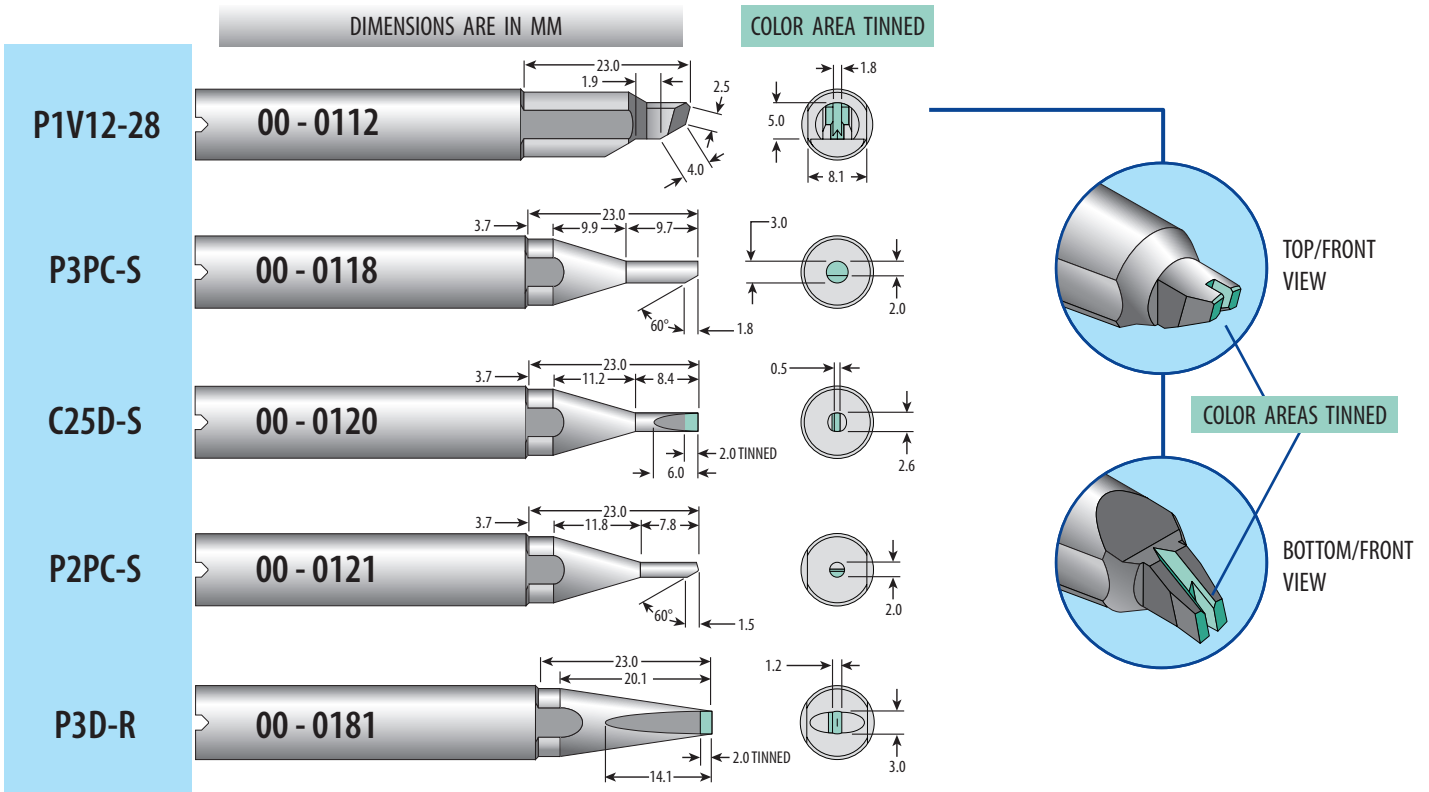

CUSTOM TIP ENGINEERING

Plato has a full-service engineering lab to custom design unique tip geometries to fit exact application requirements. Slight changes to current designs can increase production throughput, improve repeatability, minimize thermal stress, and reduce misaligned solder joints.

Plato utilizes computer-controlled machining equipment, so tooling cost is minimized. Minimum production runs can be as low as 100, at a significant cost savings compared to OEM tips.

Far from producing “knock-off” tips, Plato is the global go-to manufacturer of soldering tips throughout the industry. Plato is widely known for fast heat throughput and long tip life.

Plato engineers can take you through the design process in as short as 6-weeks:

- Assess customer requirements / specifications
- Initial design & PDF drawing approval
- Prototype approval
- Full production run



Contact your Plato representative and let's work together to increase your soldering throughput, improve quality, and reduce operating cost . . .



Soldering Stations: FX-888, FX-888D, FX889, FR-701, FR-702, 926, 928, 936, 937, 951, 952, 958, 959, 701, 702

Soldering Handpieces: FX-8801, FX-8802, FX-8803, FX-600, 900M, 900M-ESD, 907, 907-ESD, 913

Tip drawings are actual size

Hakko® **Plato®** () = mm

POINT / CONICAL TIPS

T18-SB
900M-T-SB



.008" (0.2)



T18-BL
900M-T-LB



1/64" (0.4)



T18-I
900M-T-I



.016" (0.41)



T18-B
900M-T-B



.040" (1.0)
.250" TIN LENGTH



T18-BR02
900M-T-0.2RB



0.016" (0.4)



T18-S5
900M-T-S5



1/64" (0.4)



SCREWDRIVER / CHISEL TIPS

T18-D08
900M-T-0.8D



1/32" (0.8) (0.5)



T18-D12
900M-T-1.2D



3/64" (1.2)



T18-D16
900M-T-1.6D



1/16" (1.6)



T18-D24
900M-T-2.4D



3/32" (2.4)



T18-D32
900M-T-3.2D



1/8" (3.2)



Hakko® **Plato®** () = mm

T18-S3
900M-T-S3



13/64" (5.2)
.040" (1.0)

900M-T-H

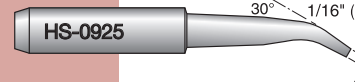

30° 1/16" (1.6)
9/64" (3.5)

BLADE / KNIFE TIPS

T18-K
900M-T-K



.2" (5.08)
1/4" (6.3) (0.1)

BEVEL TIPS

T18-C1
900M-T-1C



3/64" (1.2)

T18-C2
900M-T-2C



5/64" (2.0)

T18-C3
900M-T-3C



1/8" (3.0)

T18-C4
900M-T-4C



5/32" (4.0)

FLOW TIPS



.128" (3.3) .118" (3.0)



.195" (5.0) .135" (3.4)

Desoldering Irons: 474, 475, 701, 702B — Handpieces: 808

Hakko®	Plato®	(mm) D1	(mm) D2
A-1002	HK-0878	.030" (0.8)	.070" (1.8)
A-1003	HK-0879	.040" (1.0)	.080" (2.0)
A-1004	HK-0880	.030" (0.8)	.090" (2.3)
A-1005	HK-0881	.040" (1.0)	.100" (2.5)
A-1006	HK-0882	.050" (1.3)	.120" (3.0)
A-1007	HK-0883	.060" (1.5)	.120" (3.0)

Tip drawings are actual size

- Premium quality for long life
- Iron plated outside and stainless steel tube insert prevents solder path erosion
- All dimensions are shown before tinning and are subject to manufacturing tolerances

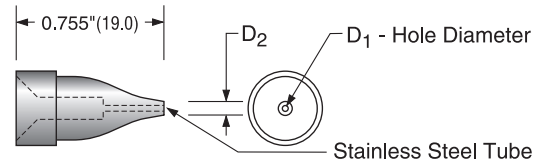

**Soldering Stations: WTCPT, WTCPTD, WTCPTFE, WTCPN, WTCPS
Soldering Handpieces: TC201T, TC201FE**



Tip drawings are actual size

Weller®	Plato®	() = mm
POINT / CONICAL TIPS		
PTS7 PTS8	C-494	1/64" (0.4)
	C-494-7 700°F / 370°C C-494-8 800°F / 425°C	
PTP7 PTP8	C-462	1/32" (0.8)
	C-462-7 700°F / 370°C C-462-8 800°F / 425°C	
SCREWDRIVER / CHISEL TIPS		
PTH7 PTH8	C-3100	1/32" (0.8)
	C-3100-7 700°F / 370°C C-3100-8 800°F / 425°C	
PTK7 PTK8	C-3043	3/64 (1.2)
	C-3043-7 700°F / 370°C C-3043-8 800°F / 425°C	

Weller®	Plato®	() = mm
PTA7 PTA8	C-3039	1/16" (1.6)
	C-3039-7 700°F / 370°C C-3039-8 800°F / 425°C	
PTB7 PTB8	C-3040	3/32" (2.4)
	C-3040-7 700°F / 370°C C-3040-8 800°F / 425°C	
PTC7 PTC8 PTC9	C-3036	1/8" (3.2)
	C-3036-7 700°F / 370°C C-3036-8 800°F / 425°C C-3036-9 900°F / 480°C	
	BEVEL TIPS	
PTCC7 PTCC8 PTCC9	C-5141	1/8" (3.2)
	C-5141-7 700°F / 370°C C-5141-8 800°F / 425°C C-5141-9 900°F / 480°C	

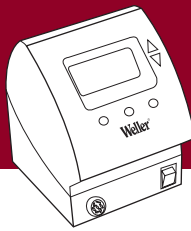

Tip drawings are actual size

Weller®	Plato®	() = mm
POINT / CONICAL TIPS		
	EW-4796	.012" (0.3)
ETS	EW-402	1/64" (0.4)
ETT	EW-401	.025" (0.6)
ETP	EW-403	1/32" (0.8)
ETO	EW-404	1/32" (0.8)
SCREWDRIVER / CHISEL TIPS		
ETH	EW-301	1/32" (0.8)
ETK	EW-304	3/64" (1.2)
ETR	EW-101	1/16" (1.6)
ETA	EW-303	1/16" (1.6)
ETL	EW-306	5/64" (2.0)

Weller®	Plato®	() = mm
ETB	EW-305	3/32" (2.4)
ETC	EW-307	1/8" (3.2)
ETD	EW-103	3/16" (4.8)
ETE	EW-105	7/32" (5.6)
BEVEL TIPS		
ETV	EW-511	1/32" (0.8)
ETAA	EW-513	1/16" (1.6)
ETBB	EW-515	3/32" (2.4)
ETCC	EW-517	1/8" (3.2)
FLOW TIPS		
ETGW	EW-0574	.195" (5.0) SMD Flow Tip .135" (3.4)

Soldering Stations: WSL, WSL2, WD1, WD2, WS80, WSD80, WSD81
 Soldering Handpieces: WSP80, MPR80

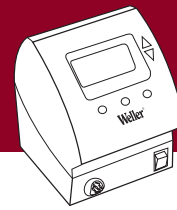

PLATO

WELLER
 COMPATIBLE

Tip drawings are actual size

Weller®	Plato®	() = mm
POINT / CONICAL TIPS		
LT1S	MS-4100	
LT1	MS-4120	
LT1L	MS-4110	
—	MS-4140	
SCREWDRIVER / CHISEL TIPS		
LTH	MS-3110	
LTK	MS-3150	
LTK	MS-3200	
LTL	MS-3250	

Weller®	Plato®	() = mm
LTK	MS-3300	
LTK	MS-3400	
LTM	MS-3450	
LTK	MS-3600	
LT4X	MS-3125	
LTHX	MS-3101	
BEVEL TIPS		
LT4W	MS-5160	
FLOW TIPS		
LTGW	MS-0100	

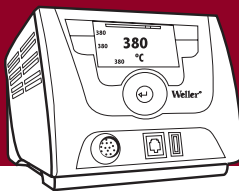

Soldering Station: WX
 Soldering Handpiece: WXP120 Iron

PLATO

WELLER
 COMPATIBLE

Tip drawings are actual size

Weller®	Plato®	() = mm
XTAA	XT-5016	
XTO	XT-4010	
XTH	XT-3008	
XTA	XT-3016	

Weller®	Plato®	() = mm
XTAL	XT-3016B	
XTC	XT-3032	
XTD	XT-3046	

Desoldering Tips to Replace Pace Endura Tips Desoldering Irons: SX90, SX-80 and SX-70 with Paper Chamber 3/16" Diameter

Pace®	Plato®	D1 (mm)	D2 (mm)
1121-0624	30-0401	.04" (1.0)	.09" (2.3)
1121-0679	30-1400	.04" (1.0)	.09" (2.3)

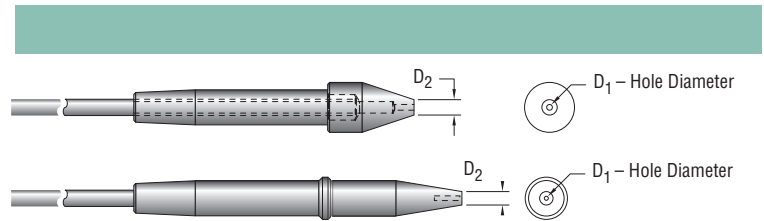

Desoldering Irons: SX90, SX-80 and SX-70 with Glass Chamber 3/16" Diameter

Pace®	Plato®	D1 (mm)	D2 (mm)
1121-0342	30-0400	.040" (1.0)	.085" (2.2)
---	30-050	.050" (1.3)	.095" (2.4)
1121-0368	30-0600	.060" (1.5)	.115" (2.9)
1121-0507	30-0900	.090" (2.3)	.190" (4.8)

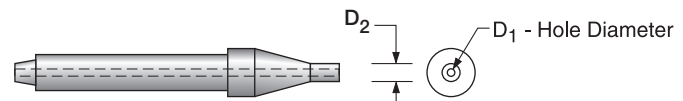

Desoldering Irons: Pace®, Air-Vac®, A.P.E.

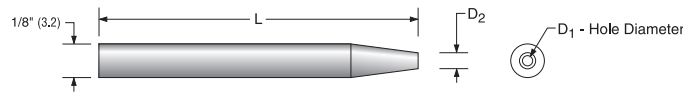





Pace®	Plato®	L (mm)	D1 (mm)	D2 (mm)	Pace®	Plato®	L (mm)	D1 (mm)	D2 (mm)
Plato® Tips to fit Pace® SX-20, SX-25, SX-25V SODR-X-TRACTORS®					Plato® Tips to fit Pace® SX-40A, SX-55A, SX-65A, SX-70 SODR-X-TRACTORS® with Plato Adapter 33-0001				
1121-0480	20-0114	1.125" (28.6)	.030" (0.8)	.060" (1.5)	1121-0485	20-025	1.875" (47.6)	.030" (0.8)	.080" (2.0)
---	20-0815	1.125" (28.6)	.036" (0.9)	.065" (1.7)	1121-0486	20-040	1.875" (47.6)	.040" (1.0)	.080" (2.0)
1121-0479	20-0110	1.125" (28.6)	.040" (1.0)	.080" (2.0)	1121-0255	20-060	1.875" (47.6)	.060" (1.5)	.100" (2.5)
1121-0216	20-0113	1.125" (28.6)	.050" (1.3)	.090" (2.3)					
1121-0217	20-0111	1.125" (28.6)	.060" (1.5)	.100" (2.5)					



3/16" Shank Diameter for Soldering Irons: PS-90, PS-80, SP-2, IR-70

PACE®

COMPATIBLE

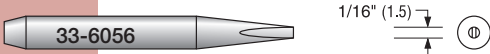
Tip drawings are actual size

Pace®	Plato® Tip
POINT / CONICAL TIPS	
1121-0336	33-8142 
1121-0357	33-8141 
1121-0526	33-3982 
SCREWDRIVER / CHISEL TIPS	
1121-0359	33-1144 
1121-0360	33-6057 
1121-0414	33-6056 

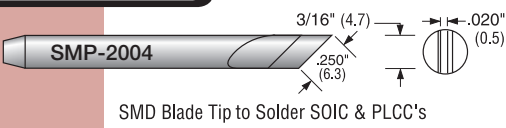
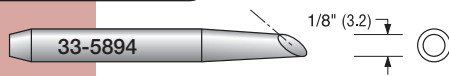
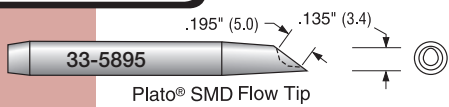

Pace®	Plato® T
1121-0337	33-6058 
1121-0358	33-1658 
BLADE / KNIFE TIPS	
1121-0402	SMP-2004 
BEVEL TIPS	
1121-0406	33-5894 
FLOW TIPS	
1121-0490	33-5895 

Soldering Stations: Analog 60, Analog 60A, RDS80, Digital 2000 with Power Tool, Ersa Twin 80 A with 0680CDJ, Analog 80, Analog 80A, Digital 80A, Multi Pro, Micro-Con 60 IA, ELS 8000/M/D, MS 6000, MS 8000/D

ERSA®

COMPATIBLE

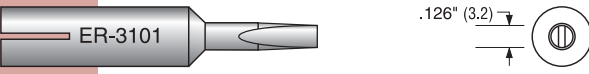
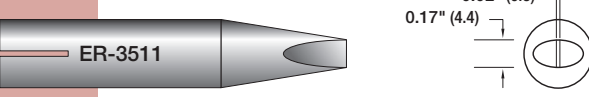
Tip drawings are actual size

Ersa®	Plato® Tip
832ED	ER-3101 
832VD	ER-3511 
832UD	ER-4005 

Soldering Stations: SMT 60, Digital 2000 with Micro Tool, Twin 80 A with Micro Tool

ERSA®

COMPATIBLE

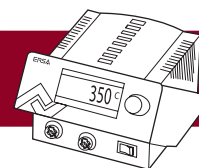

















Tip drawing is actual size

Ersa®	Plato®	() = mm
212BD	ER-4007 	

1/4" TIPS









1/4" (6.4mm) Plato® Tips to fit Soldering Irons For Hexacon® • American Beauty® • Esico®







PLATO®

Hexacon®	American Beauty®	Esico®	Plato®	Plato® Tip	Tip drawings are actual size.
HT359	716	422-108 422-132	42-355	 1/16" (1.6)	
HT358	714	422-347 422-144	42-347	 3/32" (2.4)	
HT417	721	420-106 420-119	44-390	 1/8" (3.2)	
HT426	---	420-114	44-715	 1/8" (3.2)	
HT397	720	420-143 420-164	44-386	 5/32" (4.0)	
HT313	715	---	44-352	 3/16" (4.8)	
HT552	---	426-161 426-173	46-626	 3/16" (4.8)	
HT553* *similar	704	410-140 410-126	44-152	 1/4" (6.4)	

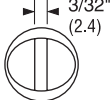

5/16" TIPS

5/16" (8.0mm) Plato® Tips to fit Hexacon® Soldering Irons

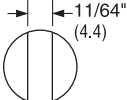
Hexicon®	Plato®	Plato® Tip	Tip drawings are actual size.
HT556	55-336	 1/8" (3.2)	
HT5550	55-321	 3/16" (4.8)	
HT547	55-118	 5/16" (8.0)	
	55-133	 5/16" (8.0)	

Hexacon®	American Beauty®	Plato® Tip	Tip drawings are actual size.
HT108		66-409	1/16" (1.6) 
HT566	43D	66-201	1/16" (1.6) 
HT129	43S	66-367	3/16" (4.8) 
		66-627	3/16" (4.8) 
HT449	823	66-300	1/4" (6.4) 
HT470		66-349	5/16" (8.0) 
HT151		66-145	3/8" (9.5) 
	43C	66-704	3/8" (9.5) 

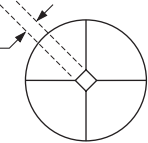
**5/8" (15.9mm) Plato® Tips to fit Soldering Irons For
Hexacon® • American Beauty® • Esico® • Weller® Marksman SP175**

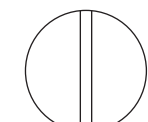
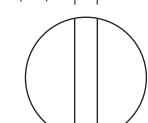
Hexacon®	American Beauty®	Weller®	Plato® Tip	Tip drawings are actual size.
HT256	44D		1010-286	1/16" (1.6) 
HT178	44S		1010-397	5/16" (8.0) 
HT499	44C		1010-184	5/8" (15.9) 
HT891		MTG40	1010-104	5/8" (15.9) 



TIPS CROSS REFERENCE

American Beauty	PLATO®	Pg #									
43C	66-704	15	900M-T-K	HS-0927	8	HT556	55-336	14	ETL	EW-306	10
43D	66-201	15	900M-T-LB	HS-4786	8	HT566	66-201	15	ETO	EW-404	10
44C	1010-184	15	900M-T-S3	HS-1665	8	HT891	1010-104	15	ETP	EW-403	10
44D	1010-286	15	900M-T-S5	HS-8157	8	Japan Unix			ETR	EW-101	10
704	44-152	14	900M-T-SB	HS-4988	8	P1V12-28	00-0112	7	ETS	EW-402	10
714	42-347	14	A1002	HK-0878	9	P3PC-S	00-0118	7	ETT	EW-401	10
715	44-352	14	A1003	HK-0879	9	C25D-S	00-0120	7	ETV	EW-511	10
716	42-355	14	A1004	HK-0880	9	P2PC-S	00-0121	7		MS-4140	11
720	44-386	14	A1005	HK-0881	9	P3D-R	00-0181	7	LT1	MS-4120	11
721	44-390	14	A1006	HK-0882	9	Pace			LT1L	MS-4110	11
823	66-300	15	A1007	HK-0883	9		20-0815	12	LT1S	MS-4100	11
8-I	A-417	13	T18-B	HS-4785	8		30-050	12	LT4W	MS-5160	11
Ersa			T18-BL	HS-4786	8	1121-0216	20-0113	12	LT4X	MS-3125	11
212BD	ER-4007	12	T18-BR02	HS-4791	8	1121-0217	20-0111	12	LTA	MS-3200	11
832ED	ER-3101	13	T18-C1	HS-5701	8	1121-0255	20-060	12	LTB	MS-3300	11
832UD	ER-4005	13	T18-C2	HS-5702	8	1121-0336	33-8142	13	LTC	MS-3400	11
832VD	ER-3511	13	T18-C3	HS-5703	8	1121-0337	33-6058	13	LTD	MS-3600	11
Esico			T18-C4	HS-5875	8	1121-0342	30-0400	12	LTGW	MS-0100	11
410-126	44-152	14	T18-D08	HS-2863	8	1121-0342	30-0400	12	LTH	MS-3110	11
410-140	44-152	14	T18-D12	HS-2796	8	1121-0357	33-8141	13	LTHX	MS-3101	11
420-106	44-390	14	T18-D16	HS-2751	8	1121-0358	33-1658	13	LTK	MS-3150	11
420-114	44-715	14	T18-D24	HS-2752	8	1121-0359	33-1144	13	LTL	MS-3250	11
420-119	44-390	14	T18-D32	HS-2753	8	1121-0360	33-6057	13	LTM	MS-3450	11
420-143	44-386	14	T18-I	HS-4787	8	1121-0368	30-0600	12	MTG40	1010-104	15
420-164	44-386	14	T18-K	HS-0927	8	1121-0402	SMP-2004	13	PTA7	C-3039-7	9
422-108	42-355	14	T18-S3	HS-1665	8	1121-0406	33-5894	13	PTA8	C-3039-8	9
422-132	42-355	14	T18-S5	HS-8157	8	1121-0414	33-6056	13	PTB7	C-3040-7	9
422-144	42-347	14	T18-SB	HS-4988	8	1121-0479	20-0110	12	PTB8	C-3040-8	9
422-347	42-347	14	Hexacon			1121-0480	20-0114	12	PTC7	C-3036-7	9
426-161	46-626	14		PLATO®	Pg #	1121-0485	20-025	12	PTC8	C-3036-8	9
426-173	46-626	14		55-133	14	1121-0486	20-040	12	PTC9	C-3036-9	9
Hakko				66-627	15	1121-0490	33-5895	13	PTCC7	C-5141-7	9
	HS-0530	8	HT108	66-409	15	1121-0507	30-0900	12	PTCC8	C-5141-8	9
	HS-0531	8	HT129	66-367	15	1121-0526	33-3982	13	PTCC9	C-5141-9	9
900M-T-0.2RB	HS-4791	8	HT151	66-145	15	1121-0624	30-0401	12	PTH7	C-3100-7	9
900M-T-0.8 D	HS-2863	8	HT178	1010-397	15	1121-0679	30-1400	12	PTH8	C-3100-8	9
900M-T-1.2D	HS-2796	8	HT256	1010-286	15	Weller			PTK7	C-3043-7	9
900M-T-1.6D	HS-2751	8	HT313	44-352	14		EW-4796	10	PTK8	C-3043-8	9
900M-T-1C	HS-5701	8	HT358	42-347	14	ETA	EW-303	10	PTP7	C-462-7	9
900M-T-2.4D	HS-2752	8	HT359	42-355	14	ETAA	EW-513	10	PTP8	C-462-8	9
900M-T-2C	HS-5702	8	HT397	44-386	14	ETB	EW-305	10	PTS7	C-494-7	9
900M-T-3.2D	HS-2753	8	HT417	44-390	14	ETBB	EW-515	10	PTS8	C-494-8	9
900M-T-3C	HS-5703	8	HT426	44-715	14	ETC	EW-307	10	XTA	XT-3016	11
900M-T-4C	HS-5875	8	HT449	66-300	15	ETCC	EW-517	10	XTAA	XT-5016	11
900M-T-B	HS-4785	8	HT470	66-349	15	ETD	EW-103	10	XTAL	XT-3016B	11
900M-T-H	HS-0925	8	HT499	1010-184	15	ETE	EW-105	10	XTC	XT-3032	11
900M-T-I	HS-4787	8	HT547	55-118	14	ETGW	EW-0574	10	XTD	XT-3046	11
			HT552	46-626	14	ETH	EW-301	10	XTH	XT-3008	11
			HT553	44-152	14	ETK	EW-304	10	XTO	XT-4010	11
			HT5550	55-321	14						



8125 Cobb Center Drive • Kennesaw, GA 30152
 Toll Free: 800-858-4043 • Tel: 678-819-1408
 E-mail: info@platoproducts.com



SCAN FOR MOBILE SITE