

Voice / Data Communication Components & Accessories

Page #

CAT 6 PATCH CORDS	2
ENHANCED CAT 5e PATCH CORDS	3
CAT 5e & CAT 5 PATCH CORDS	4
PATCH CORDS	5
FIBER OPTICS PATCH CORDS, ADAPTORS & CONNECTORS	6
TELCO CABLES	7
PATCH PANELS	8
TELCO BREAKOUTS, OCTOPUS CABLES	9
PANEL ACCESSORIES	10
DATA OUTLET: WALL PLATES	11
DATA OUTLET: KEYSTONE JACKS	12-13
DATA OUTLET: PANELS & BLOCKS	14
SWITCHES, HUBS & TESTERS	15
CATEGORY CABLES	16
MODULAR CABLES AND CONNECTORS	17
MODULAR TO D-SUB ADAPTOR KITS	18-19
MODULAR PLUGS	20
MODULAR PLUGS & BOOTS	21
MODULAR COMPONENTS	22
MODULAR ACCESSORIES	23
MODULAR WALL PLATES & JACKS	24
LAN COMPONENTS	25-26
LEGACY LAN COMPONENTS	27-28
POWER STRIPS & PANEL RACKS	29
STAINLESS STEEL WALL PLATES	30
19" RACK MOUNT PANELS	31-32
LOADED PANELS & WALL PLATES	33
PUNCH DOWN TOOLS FOR KEYSTONE	34
MODULAR CRIMPING TOOLS	35-36



CAT 6 PATCH CORDS

Cables used meets ISO/IEC 11801. EIA/TIA 568A Cat 6 Standard verified.
All RJ-45 plugs used are UL listed with 50µ" gold plated contacts.

MOLDED STRAIN RELIEF CORDS

- CAT 6 performance specification to 250MHz. Tested to 500MHz.
- 4 Pair 24 AWG Stranded , polyolefin insulation, twisted pairs, no rip-cord, PVC jacket.
- Molded strain relief to ensure the best performance.
- Custom color and length available upon request.
- 1,000ft/ Roll Bulk Wire also available
- Long Body Staggered Plugs
(Plug Also Available See Page 21, [PT-0688-50UL](#))



DC-568P-(LL) (CC) M

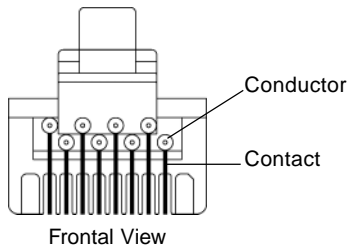

Available Colors (CC) BK, BL, GR, YW, WH.

Available Footage (LL) 3, 5, 7, 10, 15, 20, 25, 50, 100.

MOLDED SNAGLESS BOOT CORDS

- CAT 6 performance specification to 250MHz. Tested to 500MHz.
- 4 Pair 24 AWG Stranded , polyolefin insulation, twisted pairs, no rip-cord, PVC jacket.
- Molded strain relief to ensure the best performance.
- Custom color and length available upon request.
- 1,000ft/ Roll Bulk Wire also available
- Short Body Staggered Plugs



DC-568P-(LL) (CC) MB

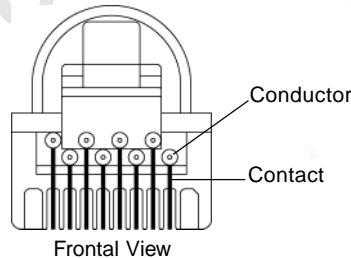

Available Colors (CC) BK, BL, GR, YW, WH.

Available Footage (LL) 3, 5, 7, 10, 15, 20, 25, 50, 100.

(CC) Color Abbreviation Chart	Beige (BG)	Black (BK)	Blue (BL)	Green (GN)	Gray (GR)	Ivory (IV)	Orange (OR)	Pink (PK)	Red (RD)	Translucent Clear (TC)	Teal (TL)	Violet (VL)	Yellow (YW)	White (WH)



ENHANCED CAT 5e PATCH CORDS

Cables used meets ISO/IEC 11801. EIA/TIA 568A Cat 5e Standard verified.
All RJ-45 plugs used are UL listed with 50µ" gold plated contacts.

QUALITY PLAIN TERMINATED CORDS

- With Generic RJ-45 Plugs

DC-5E8Q-(LL) (CC)

Available Footage (LL)

2, 3, 4, 5, 6, 7, 10, 12, 15, 20, 25

Available Colors (CC)

BG, BK, BL, GN, GR, OR, RD, YW, WH.



QUALITY SERIES

PREMIUM PLAIN TERMINATED CORDS

DC-5E8P-(LL) (CC)

Available Footage (LL)

2, 3, 4, 5, 6, 7, 10, 15, 20, 25, 50, 100

Additional length: 12' in Blue and Gray;

1', 1.5' in Beige, Blue, Gray, Red & Yellow;

14' in Gray Only

Available Colors (CC)

BG, BK, BL, GN, GR, OR, PK, RD, VL, YW, WH.



PREMIUM SERIES

QUALITY SNAGLESS BOOT CORDS

- With Generic Short RJ-45 Plugs
- Low Crosstalk Plug Body Design

DC-5E8Q-(LL) (CC) MB

Available Footage(LL)

2, 3, 4, 5, 6, 7, 10, 12, 15, 20, 25, 50, 75, 100

Available Colors (CC)

BG, BK, BL, GN, GR, OR, RD, TC, TL, YW, WH.



QUALITY SERIES

PREMIUM SNAGLESS BOOT CORDS

- Molded with Boot

DC-5E8P-(LL) (CC) MB

Available Footage(LL)

3, 5, 7, 10, 15, 25, 50, 100

Available Colors (CC)

BG, BK, BL, GN, GR, RD, YW, WH.



PREMIUM SERIES

(CC) Color Abbreviation Chart	Beige (BG)	Black (BK)	Blue (BL)	Green (GN)	Gray (GR)	Ivory (IV)	Orange (OR)	Pink (PK)	Red (RD)	Translucent Clear (TC)	Teal (TL)	Violet (VL)	Yellow (YW)	White (WH)
-------------------------------------	---------------	---------------	--------------	---------------	--------------	---------------	----------------	--------------	-------------	---------------------------	--------------	----------------	----------------	---------------



CAT 5e & CAT 5 PATCH CORDS

Enhanced Cables used meets ISO/IEC 11801. EIA/TIA 568A Cat 5e Standard verified. All RJ-45 plugs used are UL listed with 50µ" gold plated contacts. 568B wiring unless specified.

MOLDED STRAIN RELIEF CORD

DC-5E8P-(LL) (CC) M

DC-558P-(LL) (CC) M

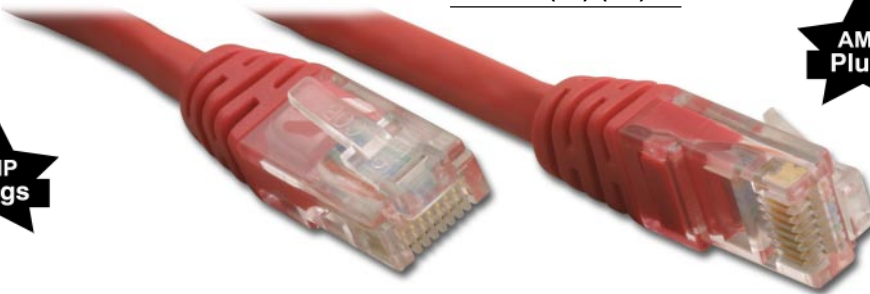

Available Footage(LL) 3, 5, 7, 10, 15, 25.

Available Colors (CC) BG, BK, BL, GN, GR, RD, YW, WH.

Available Footage(LL) 3, 5, 7, 10, 15, 25.

Available Colors (CC) BG, BK, BL, GN, GR, RD, YW, WH.

HUB CORDS (Cross Connect Hub to Hub)



Blue(BL) or Red(RD) cable with **Yellow(YW)** color molded strain relief to clearly identify and differentiate from regular type molded patch cords. Custom color cable and color coding of strain relief available. Please call for lead time and quantity requirement.

- Upgrade to CAT6 Option Available



DC-568P-(LL) BL H

Blue with Yellow
Molded Strain Relief
Available Footage (LL)
1, 2, 3, 4, 5, 7, 10, 15, 25, 50.

DC-568P-(LL) RD H

Red with Yellow
Molded Strain Relief
Available Footage(LL)
3, 5, 7, 10, 15, 25.

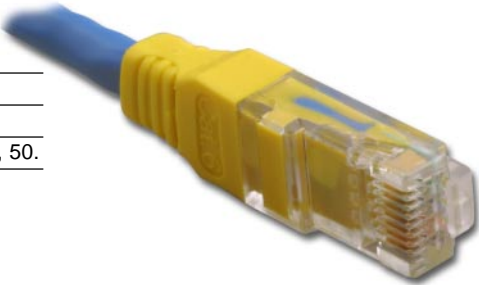

Great for Peer to Peer



DC-558P-(LL) BL H

Available Footage (LL) 75, 100.

SHIELDED PATCH CORD

- Fully Shielded RJ-45 Plug
- Molded with Snagless Boot

All cables are made to ISO standard (European Shielded Standard). Stranded with 24 AWG twisted pair conductors. 24 AWG twisted pair conductors. Verified to EIA/TIA 568A TSB-40A category 5.

DCS-558-(LL) GR MB

Available in Gray (GR)
Available Footage (LL)
2, 3, 4, 5, 6, 7, 10, 15, 20, 25, 50, 100.



(CC) Color Abbreviation Chart	Beige (BG)	Black (BK)	Blue (BL)	Green (GN)	Gray (GR)	Ivory (IV)	Orange (OR)	Pink (PK)	Red (RD)	Translucent Clear (TC)	Teal (TL)	Violet (VL)	Yellow (YW)	White (WH)
---	------------	------------	-----------	------------	-----------	------------	-------------	-----------	----------	------------------------	-----------	-------------	-------------	------------

PATCH CORDS



110 TYPE PATCH PLUG CAT 5 PATCH CORD

- Stranded 4 Pair Cable
- Custom Order NC/NR

PPS-1101S-(LL)-(CC)	1pr. 110/RJ45 Patch Cord
PPS-1101D-(LL)-(CC)	1pr. 110 Dual End Patch Cord
PPS-1102S-(LL)-(CC)	2pr. 110/RJ45 Patch Cord
PPS-1102D-(LL)-(CC)	2pr. 110 Dual End Patch Cord
PPS-1103S-(LL)-(CC)	3pr. 110/RJ45 Patch Cord
PPS-1103D-(LL)-(CC)	3pr. 110 Dual End Patch Cord
PPS-1104S-(LL)-(CC)	4pr. 110/RJ45 Patch Cord
PPS-1104D-(LL)-(CC)	4pr. 110 Dual End Patch Cord

Available Footage(LL)

1, 2, 3, 4, 5, 6, 7, 10, 15, 20, 25, 50, 75, 100.

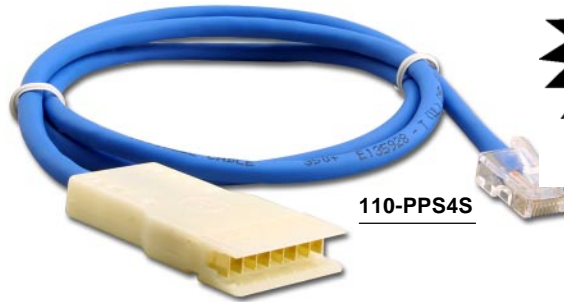

110-PPS4S



Available Colors (CC) See Color Chart Below

QUALITY SNAGLESS BOOT CORDS

- With Generic Short RJ-45 Plugs
- Low Crosstalk Plug Bodey Design
- 50µ" Gold Plated RJ45 Plugs
- Upgrade Option Available



DC-558Q-(LL) (CC) MB

Available Footage(LL)

2, 3, 4, 5, 6, 7, 10, 12, 15, 20, 25, 50, 75, 100.



Available Colors (CC)

BG, BK, BL, GN, GR, OR, RD, YW, WH.



PREMIUM SNAGLESS BOOT CORDS

- Molded with Boot
- 50µ" Gold Plated RJ45 Plugs
- Upgrade Option Available



DC-558P-(LL) (CC) MB

Available Footage(LL)

3, 5, 7, 10, 15, 25, 50, 100



Available Colors (CC)

BG, BK, BL, GN, GR, RD, YW, WH.



CAT 5 FLAT PATCH CORD

- CAT 5 Twisted Pair Cable
- Flat, Great for Tight Spaces
- Molded Snagless Boots
- White Jacket Color
- 50µ" Gold Plated RJ45 Plugs



DC-558PF-(LL) MB

Available Footage (LL)

2, 3, 4, 5, 6, 7, 10, 15, 20, 25, 50, 100.



TWISTED PAIR CORDS

LEVEL 4

- Gold Plated Contacts
- 24 AWG Stranded Conductors
- UL Listed, Level 4
- Straight Thru, UTP Cable
- Gray Jacket Color

DC-546P-(LL) GR 6p6c Plugs

DC-548P-(LL) GR 8p8c Plugs

Available Length (LL): 3, 7, 14, 25.



FLAT CORDS

- Color Coded 26 AWG Conductors
- Silver Satin Jacket
- Straight Thru Wiring



DC-504S-(LL)SV LL=3', 7', 14', 25'

DC-506S-(LL)SV LL=3', 7', 14', 25'

DC-508S-(LL)SV LL=3', 7', 14', 25'

TWISTED PAIR CORDS

LEVEL 3

- Straight Thru, Silver Satin
- For RJ-11 or RJ-45
- 26 AWG Wires, Stranded Conductors
- Straight Thru Wiring

DC-504P-(LL)SV LL=3', 7', 14', 25'

DC-506P-(LL)SV LL=3', 7', 14', 25'

DC-508P-(LL)SV LL=2', 3', 7', 14', 25'



(CC) Color Abbreviation Chart	Beige (BG)	Black (BK)	Blue (BL)	Green (GN)	Gray (GR)	Ivory (IV)	Orange (OR)	Pink (PK)	Red (RD)	Translucent Clear (TC)	Teal (TL)	Violet (VL)	Yellow (YW)	White (WH)
-------------------------------------	---------------	---------------	--------------	---------------	--------------	---------------	----------------	--------------	-------------	---------------------------	--------------	----------------	----------------	---------------



FIBER OPTICS

PATCH CORDS



- Fiber Used Manufactured by: Siercor/ Corning, BICC General, Belden
- Duplex, Zip Cords, Multi-mode 62.5/ 125, Single Mode 10/ 125
- Durable Ceramic Tip Connectors
- Each Cord is Individually Packaged with Attenuation and Return Loss Measurements
- Custom Cable Length Available

ORDERING INFORMATION:

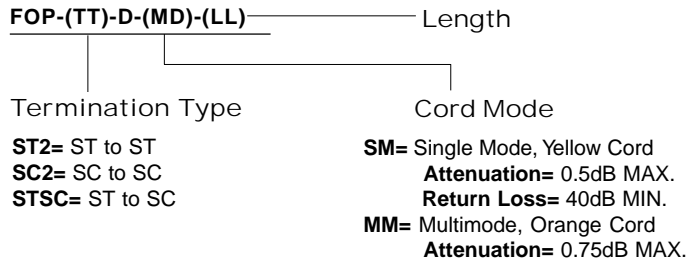

Available length in meter (LL): 1~10, 15, 20, 25.
 Custom Cable Length Available. **Please Call/ Fax/ e-mail**

ADAPTORS



- Beryllium Copper Inner Sleeves for MM Adaptor
- Ceramic Inner Sleeves for SM Adaptor

FOA-ST-MM	Fiber Adaptor ST/SC Multi Mode
FOA-ST-SM	Fiber Adaptor ST/SC Single Mode
FOA-SC-MM	Fiber Adaptor SC/SC Multi Mode
FOA-SC-SM	Fiber Adaptor SC/SC Single Mode
FOA-FC	Fiber Adaptor FC/FC
FOA-STSC-MM	Fiber Adaptor ST/SC Multi Mode
FOA-STSC-SM	Fiber Adaptor ST/SC Single Mode

CONNECTORS



- All Ceramic Tips

FOC-SC-MM	Fiber Connector SC Type MultiMode
FOC-SC-SM	Fiber Connector SC Type SingleMode
FOC-ST-MM	Fiber Connector ST Type MultiMode
FOC-ST-SM	Fiber Connector ST Type SingleMode

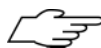

SEE PAGE 15 FOR OPTICAL TO ELECTRICAL CONNECTOR & OTHER OPTICAL ACTIVE DEVICES

TELCO CABLES



POWER SUM 350

- Lucent Certified Assembly
- Lucent CAT 5 Telco Connector
- Lucent 25 Pair CAT 5 Cable
- 120 Degree Termination Standard; 90 & 180 Degree Termination Available
- **Male End:** Unless Specified, 120° Termination is Assumed
- **Female End:** 90° Termination is Assumed
- **Custom Cable Assembly, NC/NR**
- **Please Call/ fax/ e-mail for Quotes.**



120° Termination
Male Only



90° Termination
Male or Female



180° Termination
Male Only

Male/Male (DE) or
Male Single End (SE)

Female/Female (DE) or
Female Single End (SE)

PPS-B25B-DE(LL)-PS
PPS-B25B-SE(LL)-PS

PPS-B25A-DE(LL)-PS
PPS-B25A-SE(LL)-PS

Male/Female

PPS-B25A-(LL)-PS

Footage (LL): Custom Order

CAT 5 CABLE (None Power Sum)

- Level 5; 25 Pair Cable
- 50 Pin AMP Telco Connector Gold Plated Contacts
- Color Coded to ICEA Standard
- Dual Ended Cable Wired Straight Thru
- Custom lengths Available.
- **Please Call/ fax/ e-mail for Quotes.**

Female/Female (DE) or
Female Single End (SE)

Male/Male (DE) or
Male Single End (SE)

PPS-A25B-DE(LL)-L5
PPS-A25B-SE(LL)-L5

PPS-B25B-DE(LL)-L5
PPS-B25B-SE(LL)-L5



Male/Female

PPS-B25A-(LL)-L5

Standard Footage (LL):
5, 10, 15, 20, 25, 50, 75, 100

LEVEL 3

- Level 3; 25 Pair Cable
- 50 Pin AMP Telco Connector Gold Plated Contacts
- Color Coded to ICEA Standard
- Dual Ended Cable Wired Straight Thru
- Custom Lengths Available.
- **Please Call/ fax/ e-mail for Quotes.**

Male/Male (DE) or
Male Single End (SE)

Female/Female (DE) or
Female Single End (SE)

PPS-B25B-DE(LL)
PPS-B25B-SE(LL)

PPS-A25B-DE(LL)
PPS-A25B-SE(LL)



Male/Female

PPS-B25A-(LL)

Standard Stock Footage (LL):
5, 6, 10, 15, 20, 25, 50, 75, 100



PPS-B25A-DE



PATCH PANELS

CAT 5 ENHANCED, 110 TERMINATION



- Standard Spacing for Mounting on 19" EIA Standard Racks.
- Gold plated Modular Jack Contacts.
- 110 Termination. Clear Caps & Nylon Wire Guide Included.
- Wiring: Color Coded for Both 568A & 568B Codes.

110-PP5E-128	RJ45 12 Ports 1U
110-PP5E-168	RJ45 16 Ports 1U
110-PP5E-248	RJ45 24 Ports 1U
110-PP5E-328	RJ45 32 Ports 2U
110-PP5E-488	RJ45 48 Ports 2U
110-PP5E-968	RJ45 96 Ports 4U

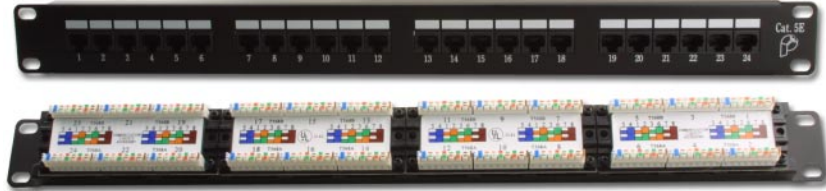

24 Port Panel (front and back view)

VERTICAL CAT 5 ENHANCED, 110 TERMINATION



- Mounts on Standard Vertical 89 Style Bracket.
- Gold Plated Modular Jack Contacts.
- 110 Termination.
- Not Including Clear Caps & Nylon Wire Guide
- Wiring: Color Coded for Both 568A & 568B Codes.

110-PP5E-128-89	12 Ports, Bracket Not Including
110-PP5E-068-89	6 Ports, Bracket Included
110-PP5E-088-89	8 Ports, Bracket Included

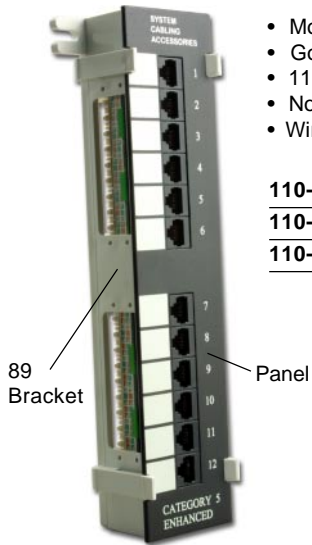

89 Bracket

Panel

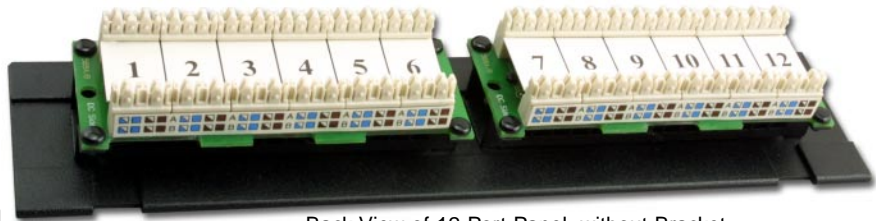

Back View of 12 Port Panel, without Bracket

CAT 3, 110 TERMINATION

- All Patch Panels Will Mount on 19" Standard EIA Racks.
- Gold plated Modular Jack Contacts.
- 110 Termination.
- Standard Wiring : EIA/TIA 568A (T), EIA/TIA 568B (AT&T)
- Special Wiring Available, please call
- Custom, NC/NR.

Ordering Information:



Back View

110-PP-(XX)(JJ)(W)

Ports (XX):

24, 32, 48, 64, 96

Jacks (JJ):

64	RJ11, 6p4c
66	RJ45, 6p6c
88	RJ45, 8p8c
84	10Base T

Wiring (W):

A	AT&T, TIA568B
T	TIA568A
BT	10Base T
U	USOC

CAT 3, TELCO CONNECTION

- All Patch Panels Will Mount on 19" Standard EIA Racks.
- Gold plated Modular Jack Contacts.
- Telco 50 pin Male Connector with Gold plated Contacts.
- Contacts Are Soldered and Insulated by Heat Shrink Tubes.
- Standard Wiring : USOC, AT&T (EIA/TIA 568B)
- Special Wiring Available, Please Call.
- Custom, NC/NR.

Back View



Ordering Information:

DC-PP-(XX)P-(JJ)-(W)

Ports (XX):

24, 32, 48, 64, 96

Jacks (JJ):

4C	RJ11
6C	RJ25
8C	RJ45

Wiring (W):

ATT	AT&T
USOC	USOC



TELCO BREAKOUTS

HARMONICA JACKS

- Gold Plated Telco & Modular Jack Contacts
- USOC, AT&T and 10Base T Wiring
- Copy of Wiring Code Included
- Include Velcro Strap, Double Sided Sticker and Screws for Mounting on Wooden Back Panel. Male or Female Telco--Both Available

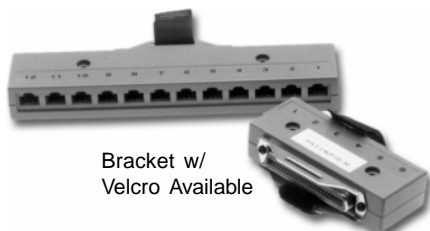

Bracket w/
Velcro Available

DC-HJ-12P4CM-USOC	RJ11, 4C Plugs, 12 Ports, Male Telco
DC-HJ-12P4CF-USOC	RJ11, 4C Plugs, 12 Ports, Female Telco
DC-HJ-8P6CM-USOC	RJ11, 6C Plugs, 8 Ports, Male Telco
DC-HJ-8P6CF-USOC	RJ11, 6C Plugs, 8 Ports, Female Telco
DC-HJ-6P8CM-USOC	RJ45, 8C Plugs, 6 Ports, Male Telco
DC-HJ-6P8CF-USOC	RJ45, 8C Plugs, 6 Ports, Female Telco
DC-HJ-6P8CM-ATT	RJ45, 8C Plugs, 6 Ports, Male Telco
DC-HJ-6P8CF-ATT	RJ45, 8C Plugs, 6 Ports, Female Telco
DC-HJ-12P8CM-10BT	RJ45, 8C Plugs, 12 Ports, Male Telco, 10 Base T
DC-HJ-12P8CF-10BT	RJ45, 8C Plugs, 12 Ports, Female Telco, 10 Base T5/bag

OCTOPUS CABLES

- Gold Plated Telco Contacts
- Male or Female Telco--Both Available
- Gold Plated MOD Plug Contacts
- USOC or AT & T Wiring
- Voice Grade
- Standard Length 4ft. Non-standard Lengths Available
- **Please Call for Quotes**



DC-TELCO-BRK

DC-OCT-12P4CM-USOC	RJ11, 4C Plugs, 12 Modular Cords, Male Telco
DC-OCT-12P4CF-USOC	RJ11, 4C Plugs, 12 Modular Cords, Female Telco
DC-OCT-8P6CM-USOC	RJ11, 6C Plugs, 8 Modular Cords, Male Telco
DC-OCT-8P6CF-USOC	RJ11, 6C Plugs, 8 Modular Cords, Female Telco
DC-OCT-6P8CM-USOC	RJ45, 8C Plugs, 6 Modular Cords, Male Telco
DC-OCT-6P8CF-USOC	RJ45, 8C Plugs, 6 Modular Cords, Female Telco
DC-OCT-6P8CM-ATT	RJ45, 8C Plugs, 6 Modular Cords, Male Telco
DC-OCT-6P8CF-ATT	RJ45, 8C Plugs, 6 Modular Cords, Female Telco

DC-TELCO-BRK	Telco Connector Bracket with Velcro Strap
---------------------	---

CLUSTER PANELS

- USOC Wiring
- Gold Plated Telco Contacts
- Gold Plated Modular Jack Contacts
- Durable, EMI Shielded Metal Casing

Single Telco

DC-CPA-4CF	RJ11, 4C, 12 Ports, Female Telco
DC-CPA-4CM	RJ11, 4C, 12 Ports, Male Telco
DC-CPA-6CF	RJ11, 6C, 8 Ports, Female Telco
DC-CPA-6CM	RJ11, 6C, 8 Ports, Male Telco
DC-CPA-8CF	RJ45, 8C, 6 Ports, Female Telco
DC-CPA-8CM	RJ45, 8C, 6 Ports, Male Telco



DC-CPA-6CF

Dual Telco

DC-CPB-4C	RJ11, 4C, 12 Ports, Dual Telco
DC-CPB-6C	RJ11, 6C, 8 Ports, Dual Telco
DC-CPB-8C	RJ45, 8C, 6 Ports, Dual Telco



DC-CPB-4C



PANEL ACCESSORIES

WIRE MANAGEMENT PANEL



- Mounting Punchouts for Both Vertical & Horizontal Positions
- Partitioned Loops for Separation of Wires
- Custom Color Loops Available **Call/ fax/ e-mail**

WMP-1U-BK Wire Management Panel, Black, 5 Loops
WMP-MLP-BK Extra Management Loops for Panel, Black



WMP Mounted on Hinged Bracket with Patch Cords Thru Loops

HINGED BRACKETS FOR 19" PANELS

- Wall Mountable **Hinged** Brackets. Metal Composition, with Pre-drilled Wall Mount Holes. Mounts all EIA Standard Spaced 19" Panels.
- Side Opening with Robber Caps.
- Depth: 3.90"

WRP-BRK-1.75	1U
WRP-BRK-3.50	2U
WRP-BRK-5.25	3U
WRP-BRK-7.0	4U
WRP-BRK-8.75	5U

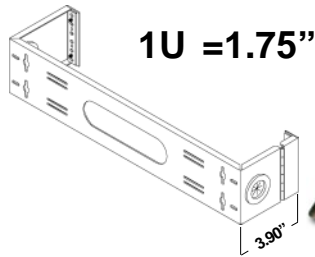

Patch Panel (1U) Mounted on Hinged Bracket, with Hinge Swing Slightly Open

DC-PPWG Wire Guide
WRP-SCR Black Mounting Screws for Panel Only

19" RACK MOUNT PANELS

FOR KEYSTONE CONNECTORS

WRP-M-12/1U	12 Port, Voice Connector, 1.75" X 19"(1U)
WRP-M-12	12 Port, Voice Connector, 3.5" X 19"(2U)
WRP-M-16/1U	16 Port, Voice Connector, 1.75" X 19"(1U)
WRP-M-16	16 Port, Voice Connector, 3.5" X 19"(2U)
WRP-M-24	24 Port, Voice Connector, 3.5" X 19"(2U)
WRP-M-32	32 Port, Voice Connector, 3.5" X 19"(2U)
WRP-M-36/3U	36 Port, Voice Connector, 5.25" X 19"(3U)
WRP-M-48/3U	48 Port, Voice Connector, 5.25" X 19"(3U)
WRP-M-48V/4U	48 Port, Voice Connector, Vertical Hole, (4U)
WRP-M-64/4U	64 Port, Voice Connector,

FOR K SERIES KEYSTONES

WRP-KM-12/1U	12 Ports, (1U)
WRP-KM-16/1U	16 Ports, (1U)
WRP-KM-24	24 Ports, (2U)
WRP-KM-32	32 Ports, (2U)

VERTICAL PANEL FOR K SERIES

WRP-K66M-12 12 Port Keystone 66 type plate with 89 Type Bracket

BLANK PLATE

WRP-19/1.75	Blank Plate, 1.75 X 19" (1U)
WRP-19/3.5	Blank Plate, 3.5 X 19" (2U)

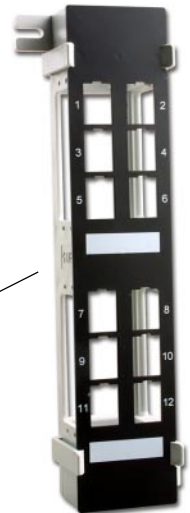

FOR DATA CONNECTOR

WRP-IBM-12	12 Port, Data Connector, 3.5" X 19" (2U)
WRP-IBM-12/1U	12 Port, Data Connector, 1.75" X 19"(1U)
WRP-IBM-16/3U	12 Port, Data Connector, 5.25" X 19" (3U)

FOR DATA CONNECTOR & KEYSTONE

WRP-IBM/M-12	12 Port Set, Data & Voice, 3.5" X 19" (2U)
---------------------	--



WRP-M-48V/4U



WRP- IBM-16/3U



WRP- IBM/M-12



WRP-M-12/1U

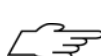

SEE PAGES 31, AND 32 FOR OTHER TYPES OF PANELS



DATA OUTLET: WALL PLATES

K SERIES PLATES

- Single Gang Plates
- Up to Six Rectangular Openings for Keystone Type Inserts
- UL Listed, Pre-Packaged in Header Bags
- Clear Label Covers for Screw Holes
- Available Colors (CC): Ivory (IV), White (WH)

WPP-K(X)-(CC)



Port Options (X): 1, 2, 3, 4, 6

Each Plate Packaged with:

Wall Plate (1pc), Red Icons (4pcs), Blue Icons (4pcs), Blank Icons (2pcs), Blank Block (1pc), Clear Label Covers (2pcs), Screws (2pcs).

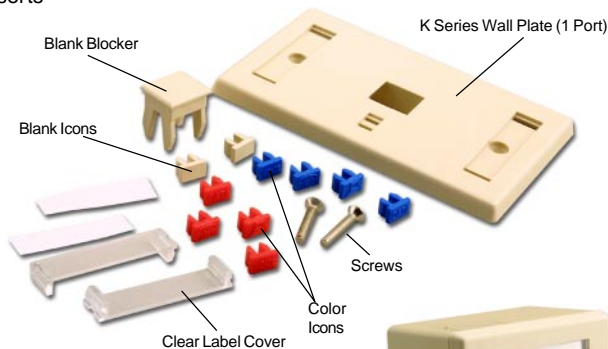

Dual Port K Series Wall Plate Mounted on PT-115A Wall Box

Extra Parts

WPP-KB-CC Blank Blocker for Wall Plate

WPP-K-SCREW Screw for Wall Plate

WPP-K-CLC Clear Label Cover

ICONS FOR K SERIES PLATES

- Available Colors (CC): Blue (BL), Red (RD)
- Custom Colors Available. Minimum Quantity Required



TEXT ICONS

WPP-KI-C5-(CC)	CAT 5
WPP-KI-C5E-(CC)	CAT 5e
WPP-KI-C6-(CC)	CAT 6
WPP-KI-DS-(CC)	DSS
WPP-KI-DT-(CC)	DATA
WPP-KI-FX-(CC)	FAX
WPP-KI-LN-(CC)	LAN
WPP-KI-TV-(CC)	TV
WPP-KI-VC-(CC)	VOICE

GRAPHIC ICONS

WPP-KI-GDT-(CC)	DATA
WPP-KI-GFX-(CC)	FAX
WPP-KI-GSL-(CC)	LEFT SPEAKER
WPP-KI-GSR-(CC)	RIGHT SPEAKER
WPP-KI-GVC-(CC)	VOICE
WPP-KI-BLN-(CC)	BLANK

CC: BL,IV, RD, WH

DSS DS	TV TV	LAN LN
CAT5 C5	CAT6 C6	CAT5E C5E
FAX FX	DATA DT	VOICE VC
GFX GFX	GDT GDT	GVC GVC
BLN BLN	GSL GSL	GSR GSR

ORIGINAL WALL PLATES

- Single Gang Plates
- Up to six rectangular openings for keystone type inserts
- UL Listed
- Available Colors (CC): Ivory (IV), White (WH)

WPP-(X)-(CC)
WPP-(X)A-CC



Port Options (X): 1, 2, 3, 4, 6

WPP-K-SCREW Screw for Wall Plates

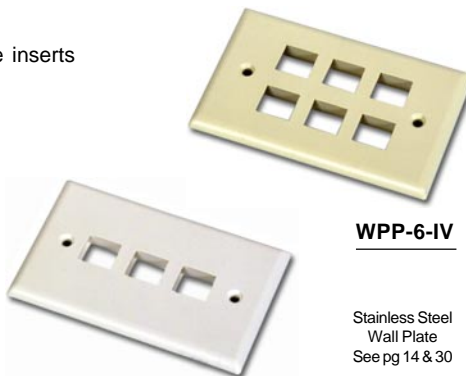

WPP-3-WH

WPP-6-IV

Stainless Steel Wall Plate
See pg 14 & 30



Dual Port Original Wall Plate Mounted on PT-115A Wall Box. With Button Port Covered by WPP-B1-WH Blank Insert



DATA OUTLET: KEYSTONE JACKS

K SERIES 180° TERMINATION JACKS

- 110 Termination, w/ 2 Pair Clear Caps
- 50µ" Gold Plated Jack Contacts
- Category 5 Enhanced
- Both 568A & B Color Coded Terminal
- Terminate 22 - 26 AWG Solid Wire

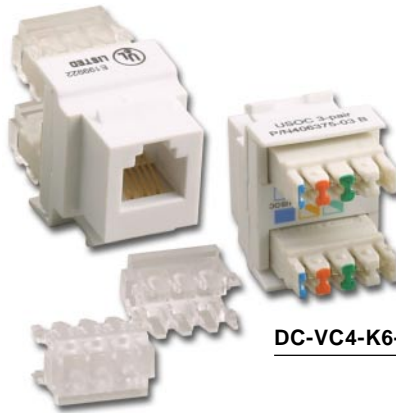

DC-VC5-K8-(CC) RJ-45, 568A & B Coded

CC: BK, BL, GN, IV, OR, RD, WH, YW

DC-VC4-K6-(CC) RJ-25, USOC Coded

CC: BK, IV, WH **LEVEL 4**

DC-VC4-K6-WH

TOOL LESS JACKS

- IDC Termination
- Clear See Thru Caps with Color Code Strip
- Category 5 Enhanced
- Fits Both K Series & Original Wall Plates



DC-VC5-8-(CC)TL RJ-45, 568A & B Coded

CC: BK, BL, DG, GN, IV, OR, RD, WH, YW
DG= Dark Green

DC-VC4-6-(CC)TL RJ-25, USOC Coded

CC: BK, IV, WH **LEVEL 4**

DC-VC5-8-DG-TL



DC-VC5-8-YW-TL

RIGHT ANGLE TERMINATION

- 110 Termination, w/ 2 Pair Clear Caps
- 50µ" Gold Plated Jack Contacts
- Category 5 Enhanced
- Terminal with both 568A & B Color Code
- Fits Both K Series & Original Wall Plates
- Terminate 22 - 26 AWG Solid Wire



DC-VC5-8-(CC)-R RJ-45, 568A & B Coded

Available Colors (CC): BK, BL, GN, IV, OR, RD, WH, YW

DC-VC4-6-(CC) R RJ-25, USOC Coded

Available Colors (CC): BK, IV, WH.

DC-VC5-8-RD-R

LEVEL 4

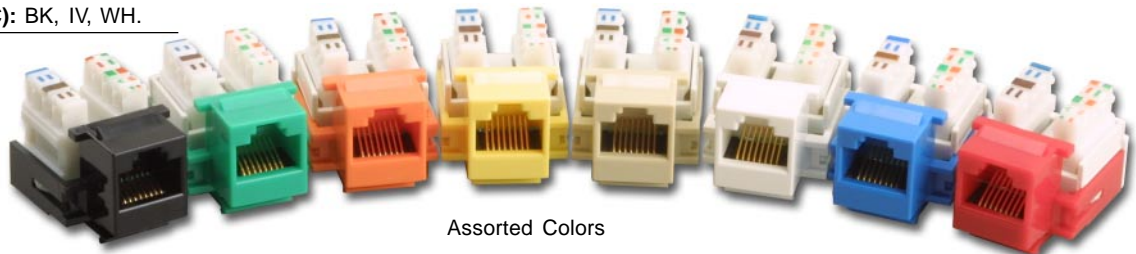

(CC) Color Abbreviation Chart	Beige (BG)	Black (BK)	Blue (BL)	Green (GN)	Gray (GR)	Ivory (IV)	Orange (OR)	Pink (PK)	Red (RD)	Translucent Clear (TC)	Teal (TL)	Violet (VL)	Yellow (YW)	White (WH)
-------------------------------------	---------------	---------------	--------------	---------------	--------------	---------------	----------------	--------------	-------------	---------------------------	--------------	----------------	----------------	---------------



DATA OUTLET: KEYSTONE JACKS

180° TERMINATION JACKS

- 110 Termination, w/ 2 Pair Caps
- TIA568A (8T) AND TIA568B (8A) or Both (8) Color Coded
- 50µ" Gold Plated Jack Contacts
- Category 5, UL Listed, TSB40A
- Terminates 22 - 26 AWG Solid Wire



DC-VC5-8-(CC) RJ-45, 568A & B Code (180°)

CC: BK, BL, GN, IV, OR, RD, WH, YW

DC-VC5-8A(CC) RJ-45, 568B Code (AT&T)

CC:BK, BL, WH, IV

DC-VC5-8T(CC) RJ-45, 568A Code

CC:BK, IV, OR, RD

DC-VC4-6 (CC) USOC 6P6C

DC-VC4-8A (CC) AT&T 8P8C

DC-VC5-SHDKT Fully Shielding Kit

DC-VC5-8AS Back Termination **Shielded Jack**

PUNCH DOWN TOOLS . PAGE 34

IDC TYPE

- IDC Termination, w/ Color Coded Cap
- Fits both Keystone Wall plates and Blocks
- Gold Plated Contacts
- USOC (6C) & AT&T (8C) Color Coded
- Terminates 24-28 AWG Conductors



DC-VC2-8C-RD

REPLACEMENT CAPS

DC-VC2-6C-(CC) 6P6C

DC-VC2-6D-(CC)* DEC

DC-VC2-8C-(CC) 8P8C

DC-VC2-8NK-(CC)** Non Keyed

(CC)* BK, IV, WH.

(CC)** BK, IV,

(CC) BK, BL, GR, IV, RD, YW, WH.

DC-VC2-6C-CAP

DC-VC2-8C-CAP

IDC TYPE

- IDC Type Termination
- Plier maybe needed to terminate



DC-VC3-6-(CC) 6P6C Jack

DC-VC3-8-(CC) 8P8C Jack

DC-VC3-CAP48-568 Translucent Keystone Jack Cap

DC-VC3-CAP48-USOC Translucent Keystone Jack Cap, USOC

Available Colors **(CC)** BK, BL, GR, IV, RD, YW, WH.

SURFACE MOUNT BOXES

PT-111-1-IV Single Port Keystone box,

PT-111-1-WH DC-VC2 Only

PT-111-2-IV Dual Port Keystone box,

PT-111-2-WH DC-VC2 Only



PT-111-2-IV

w/ DC-VC2 Keystone

Only for DC-VC2 Keystones,
WPP-B1, B2 & B3 Inserts

BARREL IDC TYPE

- IDC Termination, w/ Color Coded Cap
- Gold Plated Contacts
- USOC (6C) & AT&T (8C) Color Coded
- Terminates 24 - 28 AWG Conductors
- AMP Product, Color:Black Only



DC-VC-4C RJ11, 4C

DC-VC-6C RJ25

AMP # 553983-1

DC-VC-6CDEC

DC-VC-8CK RJ-45 KEYED

AMP # 556152-1

DC-VC-8CK

MISC. INSERTS

- Fits Keystone Blocks and Wall Plates
- Various Modules for Different Connecting Options
- Available Colors **(CC)**: Ivory **(IV)**, White **(WH)**.

WPP-B1-(CC) Blank Inserts

WPP-B2-(CC) 3/8" dia. Hole

WPP-B3-(CC) Coax Inserts

WPP-BNC1-(CC) BNC Feed Thru

WPP-RFF1-(CC) RFF Feed Thru

WPP-RCA1-(CC) RCA Feed Thru



WPP-B1-WH & IV



WPP-RFF1-WH

FEED THRU

- Allows Back to Back Feed Thru of Modular Signals
- Also Doubles as Modular Coupler
- Mounts Into WPP, WP-M Keystone Cutouts
- Gold Plated Contacts



DC-1021-6-(CC) 6P6C

DC-1021-8-(CC) 8P8C

DC-1021-8-(CC)

DC-1021-8-BK-5 8P8C, Black **CAT 5**

Colors Chart (CC)	Black (BK)	Blue (BL)	Green (GN)	Ivory (IV)	Red (RD)	Yellow (YW)	White (WH)
-------------------	------------	-----------	------------	------------	----------	-------------	------------



DATA OUTLET: PANELS & BLOCKS

UNIVERSAL FITTING PANEL

WRP-MA-12/1U	12 Port Panel, 19" x 1.75"
WRP-MA-16/1U	16 Port Panel, 19" x 1.75"
WRP-MA-24	24 Port Panel, 19" x 3.5"
WRP-MA-32	36 Port Panel, 19" x 3.5"



WRP-MA-12/1U

Stainless Steel Wall Plate

WP-MA-2	Dual Port Wall Plate for MF
WP-MA-4D	Quad Port Double Gang Wall Plate for MF



WRP-MA-16/1U (Loaded)

MODULAR FRAMES (Panel/Wall Plate Inserts)

MF-BLK-(CC)	Blank Opening Blocker
MF-BNC-(CC)	1/2" D cut out for RF
MF-BNC1-(CC)	With BNC Feed Thru
MF-FOC-(CC)	Cut out for ST fiber Coupler
MF-FOC1-(CC)	With ST Fiber Coupler
MF-KSJ-(CC)	Cut Out for Keystone Jack
MF-KSJ1-(CC)	With CAT5 Keystone Jack
MF-RFF-(CC)	3/8" D cut out for RF
MF-RFF1-(CC)	With F Coupler

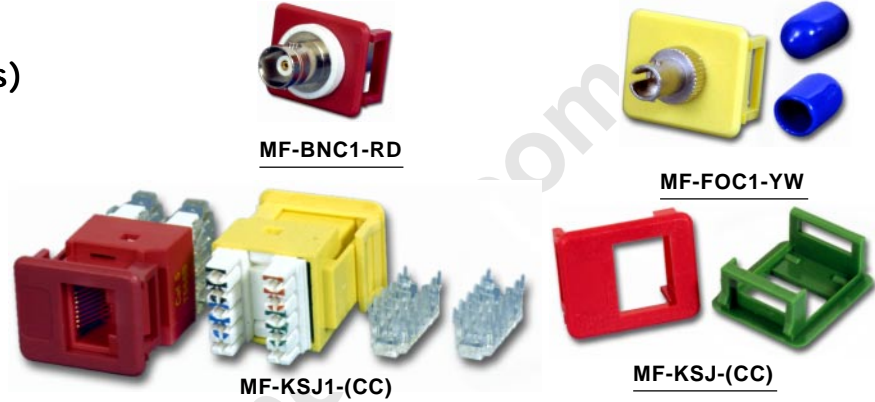

MF-BNC1-RD

MF-FOC1-YW

MF-KSJ1-(CC)

MF-KSJ-(CC)

Available Colors (CC): BK, BL, GN, IV, RD, YW, WH.

CAT 5e SURFACE MOUNT BLOCKS

- Three-directional cable exits for greater flexibility
 - Blue and red icons for instant identification of voice or data assignments
 - Write-on labels with snap-in clear protective plastic covers
 - Double Sided Sticker and Wood Screws for Mounting
 - 110 IDC w/Both T568A and T568B wiring options on the same terminal
 - Available Colors (CC): Gray (GR), Ivory (IV), White (WH).
 - Krone Terminal (LSA+) and/or Shielded version Available on Custom Bases.
- Please Call/ Fax/ e-mail

PT-1153-8-(CC)	Single Port, RJ-45, 568A & B
PT-1154-8-(CC)	Dual Ports, RJ-45, 568A & B
PT-1153-6-(CC)	Single Port, 6C, RJ-25 USOC
PT-1154-68-(CC)	Dual Ports, 6C & 8C, USOC & 568A & B

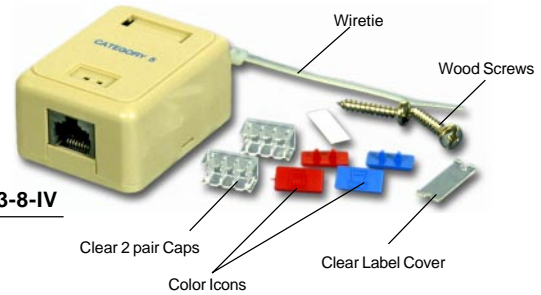

PT-1153-8-IV

SURFACE MOUNT BOXES & MODULE INSERTS

- Regular Biscuit Shape
- Up to 4 Ports Available
- Screw-on Top, Double sided Sticker and Wood Screws for Mounting
- Fits all Keystone Jacks
- Available Colors (CC): Ivory (IV), White (WH).

PT-1112-(CC)	Dual Port Box
PT-1124-(CC)	Quad Ports Box



PT-1112-IV

Box Shown with Dual Port Insert (PT-111J2-IV)

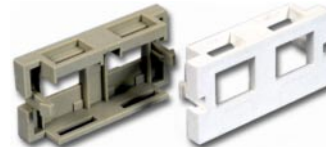

Keystone Plate Insert
PT-111J2-(CC)

PT-111J1-(CC)	Keystone, Single Port
PT-111J2-(CC)	Keystone, Dual Port
PT-111B1-(CC)	BNC Insert, Single Port
PT-111B2-(CC)	BNC Insert, Dual Port
PT-111F1-(CC)	F Insert, Single Port

(CC) Color Abbreviation Chart	Beige (BG)	Black (BK)	Blue (BL)	Green (GN)	Gray (GR)	Ivory (IV)	Orange (OR)	Pink (PK)	Red (RD)	Translucent Clear (TC)	Teal (TL)	Violet (VL)	Yellow (YW)	White (WH)
----------------------------------	------------	------------	-----------	------------	-----------	------------	-------------	-----------	----------	------------------------	-----------	-------------	-------------	------------



SWITCHES, HUBS & TESTERS

Compatibility Chart for Data Outlet Components

Part #	K Series Wall Plate Pg 11	Original Wall Plate Pg 11	PT-111-Series Pg 13	PT-1112-24 Series Pg 14	19" Panel Pg 10, 32	Mod Frame Pg 14	K Series Panel Pg 10
DC-1021 Cat5 (Pg 13)	*--	*		*	*	*	*
DC-1021 (6&8) (Pg 13)		*		*	*	*	*
DC-VC2 (6&8) (Pg 13)		*	*	*	*	*	
DC-VC3 (6&8) (Pg 13)		*		*	*	*	
DC-VC4 180°(6&8) (Pg 13)		*		*	*	*	*--
DC-VC4 K Series (6) (Pg 12)	*			*		*	*
DC-VC4 Rt. Angle (6) (Pg 12)	*	*		*	*	*	*
DC-VC4 Tool Less (6) (Pg 12)	*	*		*	*	*	*
DC-VC5 180° (Pg 13)		*		*	*	*	*
DC-VC5 K Series (Pg 12)	*			*		*	*
DC-VC5 Rt. Angle (Pg 12)	*	*		*	*	*	*
DC-VC5 Tool Less (Pg 12)	*	*		*	*	*	*--
WPP-B1 & B2 (Pg 13)		*	*				
WPP-B3 (Pg 13)		*	*				

*-- Loose Fit

10/100 SWITCHES & HUBS

10/100 HUB

HUB-100BT-8 10/100 Hub 8 Ports

10/100 SWITCHES

SWH-110-5 10/100 Switch 5 Ports, Compact

SWH-110-8 10/100 Switch 8 Ports



100BT FIBER CONVERTER

ADL-100BT2FST-MM Fiber Converter 100BT, ST/MM Max 2km

ADL-100BT2FSC-MM Fiber Converter 100BT, SC/MM Max 2km

ADL-100BT2FSC-SM Fiber Converter 100BT, SC/SM Max 60km

10/100 SWITCH WITH 100BT FIBER CONVERT

SWH-110MT-5 Fiber Converter MTRJ + 5 Ports 10/100 Switch

SWH-110VF-5 Fiber Converter VF-45 + 5 Ports 10/100 Switch

SWH-110SC-5 Fiber Converter SC + 5 Ports 10/100 Switch

SWH-110ST-5 Fiber Converter ST + 5 Ports 10/100 Switch

MODULAR INLINE COUPLERS

- Gold Plated Contacts
- Straight Thru(Data) or Reversed Wiring(Phone)
- Color: Ivory (Unless Otherwise Noted)

Phone

PT-102-4C	6P4C Jacks
PT-102-6C	6P6C Jacks
PT-102-6C-BK	6P6C Jacks Black
PT-102-6C-GR	6P6C Jacks Gray
PT-102-6C-WH	6P6C Jacks White
PT-102-8C	8P8C Jacks

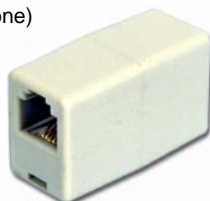

DC-102-4CD

Data

DC-102-4CD	6P4C Jacks
DC-102-6CD	6p6c Jacks
DC-102-8CD	8p8c Jacks
DC-102-10CD	10p10c Jacks, data only



DC-102-8CD-5

Data Category 5 Enhanced

DC-102-8CD-5	8P8C Jacks, Black
DCS-102-8CD-5	Shielded 8P8C Jacks



MODULAR CONTINUITY TESTERS

PT-LK-TEST-6/8 • Link Tester for RJ11 & RJ45 Mod Cord

PT-LK-TEST-DECV • Link Tester for DEC Type Mod Cords

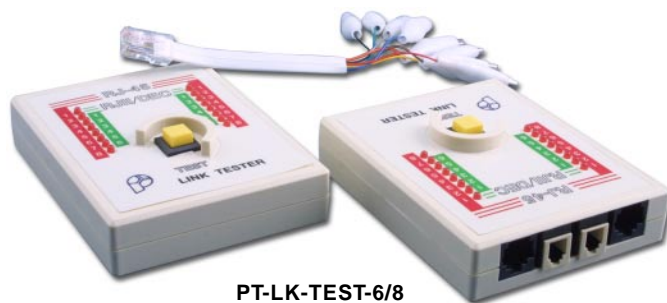

PT-LK-TEST-6/8

REMOTE CABLE TESTERS

For USOC4/6/8, Ethernet 10BaseT/10Base2, EIA/TIA-568A/B, TOKEN RING, Telephone, Apple Talk, PhoneNet Cabling System Test

TSR-RMTNET



- Powered by 9V battery
- Automatic deactivation
- Open/short wiring test
- Connected wires display
- No connection/no terminator indication
- Wrong connection/Non parallel connection display
- Ethernet 10BASE2/10BASE5 terminator value detection

Detachible Remote Module

• For wires continuity, miswiring and polarization in your network cables, thin Ethernet (BNC) / 10Base-T(UTP/STP) 356A / TIA-568A / Tia-568B & Token Ring. Using the attached remote terminator can easily test the cable before or after the cables are installed. Also allows testing of the ground of Shielded Twisted Paired Cable. The Test Jacks are a BNC Female and a RJ-45.

TSR-NETCBL





CATEGORY CABLES



CAT 6

DC-568-(CC)-1000

- All Cables are Manufactured Under **ISO 9000 Standard**
- ETL Verified to EIA/TIA 568A Category 6, Latest Draft
- UL(USA)CMR, CSA(Canada)CMG FT4, AusTel(Australia), and Fuji(Japan) Listed
- Solid Cable with Pull cord inside and footage clearly marked on jacket.
- Packaged in 1000ft Reelbox and Tested to 500MHZ.

DC-568-(CC)-1000 Stranded (for Patch Cords)
DC-568-(CC)-1000L Solid (Horizontal Installation)

Available Colors (CC) BK, BL, GR, YW, WH.

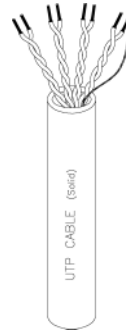

Solid



Stranded

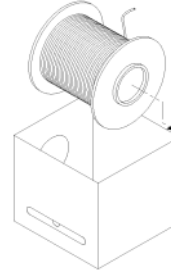

Reel Box

Bulk Category Cables
Packaged in Reel Box
to Ensure the Best
Performance

ENHANCED CAT 5



DC-5E8(CC)1000L

1000ft. Box



DC-5E8(CC)328L

100 Meter Box

• **NEW COLOR**
Powder Blue (PB)

- All Cables are Manufactured Under **ISO 9000 Standard**.
- ETL Verified to EIA/TIA 568A TSB-40A category 5.
- UL(USA) CMR, CSA(Canada) CMG FT4, AusTel(Australia), and Fuji(Japan) Listed
- Solid Cable with Pull cord inside and footage clearly marked on jacket.
- Packaged in 1000ft Reelbox and Tested to 350MHZ.

Solid

DC-5E8(CC)1000L CAT 5E Solid 4 Pair Conductor.1000ft./Reel
CC: BK, BL,GN,GR, OR, PB, PK, RD, VL, YW, WH

DC-5E8(CC)328L CAT 5E Solid 4 Pair Conductor.
328ft. (100M). Per Reel in Mini Box
CC: BK, BL,GN,GR, OR, PK, RD, VL, YW, WH.

DC-354GR1000L Solid 2 Pair Conductor

Stranded

DC-5E4(CC)2000 CAT 5E Stranded 2 Pair Conductor
2000ft./ Reel
CC: BK, BL, GR, WH.

DC-5E8(CC)1000 CAT 5E Stranded 4 Pair Conductor. 1000ft./ Reel
CC: BG, BK, BL,GN,GR, OR, PB, PK, RD, TC, TL, VL, YW, WH



CAT 5

DC-554(CC)1000 Stranded 2 Pair
CC: BG, BK, BL

DC-554GR1000-L Solid 2 Pair Gray Jacket

DC-554GR1000-L

DC-558WH1000-LT Teflon CAT 5 Solid 4 Pair White Jacket



- All Cables are Manufactured Under **ISO 9000 Standard** and are UL and CSA listed.
- ETL Verified to EIA/TIA 568A Category 5. CMR, PVC jacket.
- Solid Cable with Pull cord inside and footage clearly marked on jacket.
- Packaged in 1000ft Reelbox

Colors Chart (CC)	Beige (BG)	Black (BK)	Blue (BL)	Green (GN)	Gray (GR)	Orange (OR)	Pink (PK)	Power Blue (PB)	Red (RD)	Translucent Clear (TC)	Teal (TL)	Violet (VL)	Yellow (YW)	White (WH)
-------------------	------------	------------	-----------	------------	-----------	-------------	-----------	-----------------	----------	------------------------	-----------	-------------	-------------	------------

MODULAR CABLES AND CONNECTORS



FLAT CABLE

- 26 AWG Silver Satin (SV) or Black (BK)
- Unshielded Cable

<u>DC-W4-500BK</u>	<u>DC-W4-100</u>
<u>DC-W6-500BK</u>	<u>DC-W6-100</u>
<u>DC-W8-500BK</u>	<u>DC-W8-100</u>
<u>DC-W4-1000BK</u>	<u>DC-W4-500</u>
<u>DC-W6-1000BK</u>	<u>DC-W6-500</u>
<u>DC-W8-1000BK</u>	<u>DC-W8-500</u>
<u>DC-W4-50</u>	<u>DC-W10-500</u>
<u>DC-W6-50</u>	<u>DC-W4-1000</u>
<u>DC-W8-50</u>	<u>DC-W6-1000</u>
	<u>DC-W8-1000</u>
	<u>DC-W10-1000</u>



DC-W8-1000UL



- 26 AWG Silver Satin (SV)
- Unshielded Cable

<u>DC-W4-500UL</u>
<u>DC-W4-1000UL</u>
<u>DC-W6-500UL</u>
<u>DC-W6-1000UL</u>
<u>DC-W8-500UL</u>
<u>DC-W8-1000UL</u>



TWISTED PAIR CABLE

- Unshielded Twisted Pair Cables
- Silver Satin (SV) or Black (BK) Stranded

<u>DC-WT6-500-SV-24UL</u>	
<u>DC-WT6-1000-SV-24UL</u>	
<u>DC-WT8-500-SV-24UL</u>	
<u>DC-WT8-1000-SV-24UL</u>	

24 AWG Silver

<u>DC-WT6-500-SV-24</u>
<u>DC-WT6-1000-SV-24</u>

DC-WST4-1000024GR
24AWG Gray, 4 Conductor Solid

24 AWG Black

<u>DC-WT4-500-BK-24</u>
<u>DC-WT4-1000-BK-24</u>
<u>DC-WT6-500-BK-24</u>
<u>DC-WT6-1000-BK-24</u>

<u>DC-WT4-500-BK-24UL</u>
<u>DC-WT4-1000-BK-24UL</u>
<u>DC-WT6-500-BK-24UL</u>
<u>DC-WT6-1000-BK-24UL</u>
<u>DC-WT8-500-BK-24UL</u>
<u>DC-WT8-1000-BK-24UL</u>

26 AWG Silver

<u>DC-WT4-500</u>	<u>DC-WT2-1000</u>
<u>DC-WT4-1000</u>	<u>DC-WT8-500</u>
<u>DC-WT6-500</u>	<u>DC-WT8-1000</u>
<u>DC-WT6-1000</u>	<u>DC-WT10-500</u>
	<u>DC-WT101000</u>



DC-WT4-500

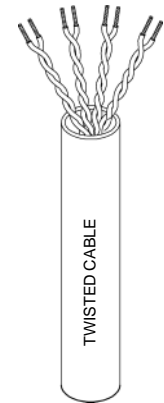

SHIELDED CAT 5



All cables are made to **ISO 9000 Standard** (European Shielded Standard). Stranded with 24 AWG twisted pair conductors. Solid with 24 AWG twisted pair conductors. Verified to EIA/TIA 568A TSB-40A category 5. Package in 1000ft Reelbox.

<u>DCS-558GR1000L</u>	Solid
<u>DCS-558GR1000</u>	Stranded



BULK COAX CABLE

- Coax braid plus foil cable 500 ft roll

<u>RG-58AU-500</u>	Stranded Center Conductor
<u>RG-58U-500</u>	Solid Center Conductor

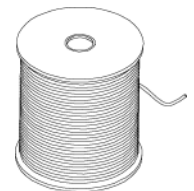

BNC MOLDED CABLES

- RG-58A Stranded or Solid Center Conductor Cables
- Gold Plated BNC Contacts
- Molded Strain Relief



<u>S-BNC58A-(LL)</u>
Stranded Center Conductor
<u>S-BNC58-(LL)</u>
Solid Center Conductor

Available Footage (LL): 03, 06, 12, 25, 50, 75, 100.

BNC COLOR CODED BOOTS

- RG-58A & 59 Stranded Conductor Cable
- Gold Plated BNC Contacts
- Molded Strain Relief



<u>BTS-58-(CC)</u>
<u>BTS-59-(CC)</u>

Colors Chart (CC)	Black (BK)	Blue (BL)	Green (GN)	Gray (GR)	Red (RD)	Yellow (YW)	White (WH)
-------------------	------------	-----------	------------	-----------	----------	-------------	------------



MODULAR TO D-SUB ADAPTOR KITS

TWO PIECE STANDARD



Nevada Western Compatible Color Code

AD-9FT4-G2	DB 9 GRAY	AD-15FT4-BK2	DB 15 BLACK
AD-9MT4-G2		AD-15MT4-BK2	
AD-9FT6-G2		AD-15FT6-BK2	
AD-9MT6-G2		AD-15MT6-BK2	
AD-9FT6-G2D			
AD-9MT6-G2D			
AD-9FT4-B2	DB 9 BLUE	AD-25FT4-G2	DB 25 GRAY
AD-9MT4-B2		AD-25MT4-G2	
AD-9FT6-B2		AD-25FT6-G2	
AD-9MT6-B2		AD-25MT6-G2	
AD-9FT4-BK2	DB 9 BLACK	AD-25FT4-B2	DB 25 BLUE
AD-9MT4-BK2		AD-25MT4-B2	
AD-9FT6-BK2		AD-25FT6-B2	
AD-9MT6-BK2		AD-25MT6-B2	

AT & T Compatible Color Code
RJ 45 Jack w/Key

AD-9FT8-G2	DB 9 GRAY	AD-15HFT8-G2	HiDen 15 GRAY
AD-9MT8-G2		AD-15HMT8-G2	
AD-9FT8-B2	DB 9 BLUE	AD-15FT8-BK2	BLACK
AD-9MT8-B2		AD-15MT8-BK2	
AD-9FT8-BK2	BLACK	AD-25FT8-G2	GRAY
AD-9MT8-BK2		AD-25MT8-G2	
AD-25FT8-BK2	BLACK	AD-25FT8-B2	BLUE
AD-25MT8-BK2		AD-25MT8-B2	
AD-9FT8-BKT2	BLACK W/THUMB SCREW	AD-25FT8-N2	METALIZED HOOD
AD-9MT8-BKT2		AD-25MT8-N2	
AD-25FT8-BKT2	BLACK W/THUMB SCREW		
AD-25MT8-BKT2			



PIN NUMBERING

- 6P6C pins are usually numbered 1 thru 6.
- If a 6 pin jack has only 4 conductors, pins are numbered 2 thru 5.
- Some 8p8c jacks have an optional notch on the side to match 8p8c data plugs.
- 10 conductor plugs, the size of 8p8c plugs with 2 extra contacts, have pins numbered 0 thru 9.

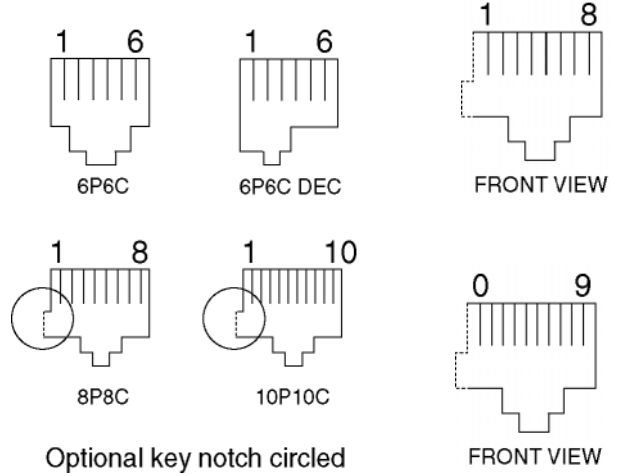

WIRING COLOR CODES

USOC (Uniform Service Ordering Code) Color Codes

PIN #	COLOR	
	6P4C	6P6C
1	-----	White
2	Black	Black
3	Red	Red
4	Green	Green
5	Yellow	Yellow
6	-----	Blue

NW (Nevada Western) Color Codes

PIN #	COLOR	
	6P4C	6P6C
1	-----	Blue
2	Yellow	Yellow
3	Green	Green
4	Red	Red
5	Black	Black
6	-----	White

AT&T (Weco) Color Codes

8P8C			
PIN #	COLOR	PIN #	COLOR
1	Blue	5	Green
2	Orange	6	Yellow
3	Black	7	Brown
4	Red	8	White

10P10C Code

10P10C			
PIN #	COLOR	PIN #	COLOR
0	Purple	5	Green
1	Blue	6	Yellow
2	Orange	7	Brown
3	Black	8	White
4	Red	9	Gray



MODULAR TO D-SUB ADAPTOR KITS

ONE PIECE STANDARD

Nevada Western Compatible Color Code

- AD-9FT4-G1
 - AD-9MT4-G1
 - AD-9FT6-G1
 - AD-9MT6-G1
 - AD-9FT6-G1D
 - AD-9MT6-G1D
- DB 9
GRAY

- AD-25FT4-G1
 - AD-25MT4-G1
 - AD-25FT6-G1
 - AD-25MT6-G1
 - AD-25FT6-G1D
 - AD-25MT6-G1D
- DB 25
GRAY

- AD-9FT6-BK1
 - AD-9MT6-BK1
- DB 9
BLACK

- AD-25FT6-B1
 - AD-25MT6-B1
- DB 25
BLUE

- AD-15FT4-G1
 - AD-15MT4-G1
 - AD-15FT6-G1
 - AD-15MT6-G1
- DB 15
GRAY

- AD-25FT4-BK1
 - AD-25MT4-BK1
 - AD-25FT6-BK1
 - AD-25MT6-BK1
- DB 25
BLACK

- AD-15FT6-G1D
 - AD-15MT6-G1D
- DEC
Type Jack

10P10C

- AD-9FT10-G1
 - AD-9MT10-G1
 - AD-25FT10-G1
 - AD-25MT10-G1
- GRAY

- AD-9FT10K-G1
 - AD-9MT10K-G1
 - AD-25FT10K-G1
 - AD-25MT10K-G1
- GRAY
KEYED

AT & T Compatible Color Code RJ 45 Jack w/Key

- AD-9FT8-G1
 - AD-9MT8-G1
- DB 9
GRAY

- AD-25FT8-G1
 - AD-25MT8-G1
 - AD-25FT8K-G1
 - AD-25MT8K-G1
- DB 25
GRAY

- AD-15FT8-BK1
 - AD-15MT8-BK1
- DB 15
BLACK

- AD-25FT8-BK1
 - AD-25MT8-BK1
- DB 25
BLACK

- AD-15FT8-G1
 - AD-15MT8-G1
- DB 15
GRAY

- AD-25FT8-B1
 - AD-25MT8-B1
- DB 25
BLUE

USOC Compatible Color Code

- AT1-G9F4
 - AT1-G9M4
 - AT1-G9F6
 - AT1-G9M6
- DB 9
GRAY

- AT1-G25F4
 - AT1-G25M4
 - AT1-G25F6
 - AT1-G25M6
- DB 25
GRAY

- AT1-G9F6DEC
 - AT1-G9M6DEC
- DEC
Type Jack

- AT1-G25F6DEC
 - AT1-G25M6DEC
- DEC
Type Jack

- AT1-G15F4
 - AT1-G15M4
 - AT1-G15F6
 - AT1-G15M6
- DB 15
GRAY

NOMENCLATURE	
9	DB9
15	DB15
25	DB25
T4 or 4	RJ11, 4C Jack
T6 or 6	RJ11, 6C Jack
D	DEC Type
T8(K)	RJ45, 8C (W/Key)
T10(K)	10C (W/Key)
G	GRAY
B	BLUE
BK	BLACK



AD-15MT6-G1D

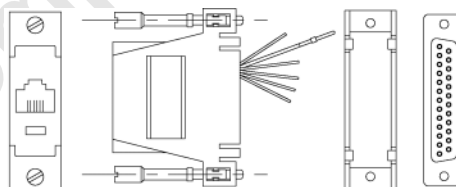

AD-25FT6-G1

DELUXE

- Molded Thumbscrews
- Different Color Options
- UL Listed
- Individually Packaged with Headers



NW Code

- ADM-9F6-GR
- ADM-9M6-GR
- ADM-25F6-(CC)
- ADM-25M6-(CC)

AT & T Code

- ADM-9F8-(CC)
- ADM-9M8-(CC)
- ADM-15F8-BK
- ADM-15M8-BK
- ADM-25F8-(CC)
- ADM-25M8-(CC)

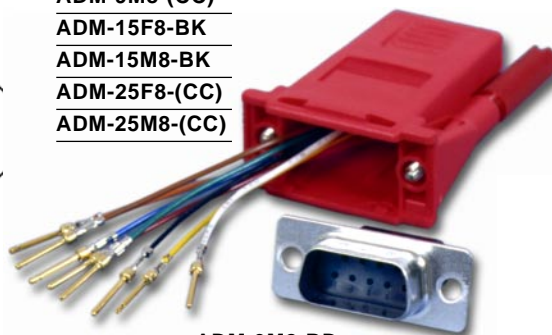

ADM-9M8-RD

ECONOMY

- Order in Lots of 100 only
- Thumbscrew and Plastic
- Gray Hoods

USOC Code

- AD-2506M-G1
- AD-2506F-G1

AT&T Code

- AD-2508M-G1
- AD-2508F-G1

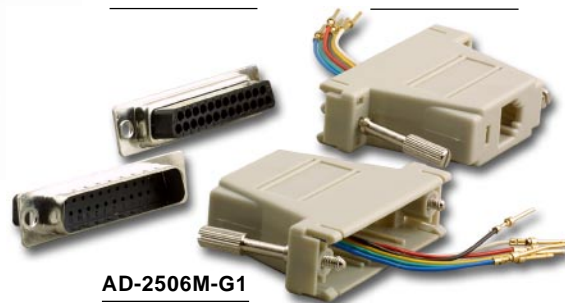

AD-2506M-G1

Colors Chart (CC)	Black (BK)	Blue (BL)	Green (GN)	Gray (GR)	Red (RD)



MODULAR PLUGS

2 Prong Stranded Flat Cable Plugs

Standard

PT-044	HANDSET
PT-064	RJ 11 6P4C
PT-066	RJ 11 6P6C
PT-066DEC	6P6C DEC
PT-088	RJ 45 8P8C
PT-088K	RJ 45 8P8C KEYED
PT-1010	10P10C
PT-1010K	10P10C KEYED
PT-1010RS	10P10C

50 "μ" Gold Plate

PT-044/50UL
PT-064/50UL
PT-066/50UL
PT-066DEC/50UL
PT-088/50UL
PT-088K/50UL

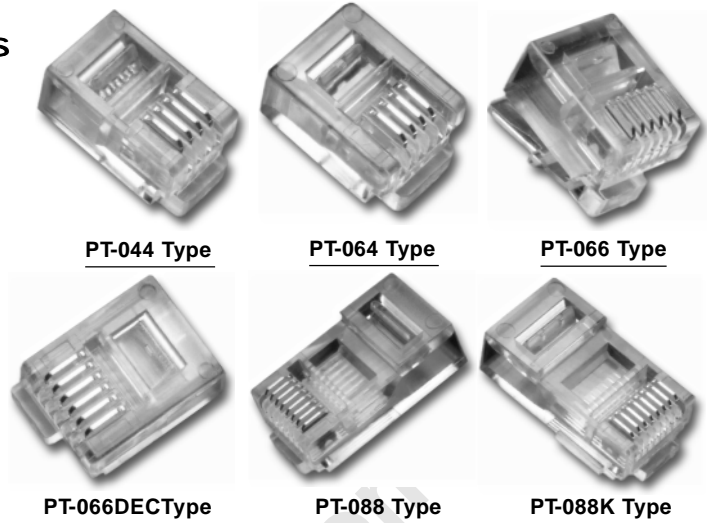

2 Prong Round Cable Plugs

For Twisted Pair Stranded, Round Cables

Standard

PT-044R	HANDSET
PT-064R	RJ 11 6P4C
PT-066R	RJ 11 6P6C
PT-088R	RJ 45 8P8C
PT-088KR	RJ 45 8P8C
-	KEYED

50 "μ" Gold Plate

PT-044R/50UL
PT-064R/50UL
PT-066R/50UL
PT-088R/50UL
PT-088KR/50UL



- Standard Plugs - Contact: 6 μ" Gold Plastic: 94V2
- 50UL-type Plugs - Contact: 50 μ" Gold Plastic: UL, 94V0

3 Prong contact on solid wire

For Solid Conductor Round Cables

Standard

PT-064RS	RJ 11 6P4C
PT-066RS	RJ 11 6P6C
PT-088RS	RJ 45 8P8C
PT-0A88RS*	
PT-088KRS	RJ 45 8P8C KEYED
PT-066DRS	6P6C DEC

50 "μ" Gold Plate

PT-064RS/50UL
PT-066RS/50UL
PT-088RS/50UL
PT-088KRS/50UL
PT-066DRS/50UL

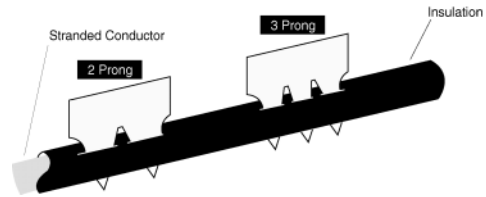

As illustrated, both 2 Prong and 3 Prong Plugs make contact on **Stranded Cable** by **piercing thru** the outer insulator of the conductors. On **solid conductor cable**, 2 Prong makes contact by **straddling** the single conductor while the 3 Prong makes contact on the solid conductor by **3 point gripping**, which gives a more stable contact.

3 Prong Round Cable Plugs

For Solid Conductor Round Cables

Standard

PT-0364R	RJ 11 6P4C
PT-0366R	RJ 11 6P6C
PT-0388R	RJ 45 8P8C
PT-0388KR	RJ 45 8P8C KEYED
PT-03A88R*	RJ 45 8P8C

50 "μ" Gold Plate

PT-0364R/50UL
PT-0366R/50UL
PT-0388R/50UL
PT-0388KR/50UL
PT-03A88R/50UL*
PT-0388-50UL

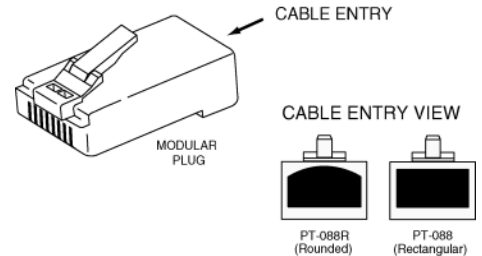

Short Body Plugs

PT-088SB	8P8C Short Body
PT-088SB/50UL	8P8C Short Body, Gold Plated UL

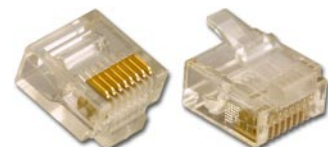

*Need to use crimp tools with AMP type dies

MODULAR PLUGS & BOOTS



CATAGORY 5 PLUGS

- For Both Standard Type and AMP Type 8p8c RJ-45 Plugs. Ratchet Mechanism, Vertical Crimping Motion for Precision Fitting of Plugs. Great for Cat5 8p8c Plugs with Inserts. (Pan # PT-0588 series)

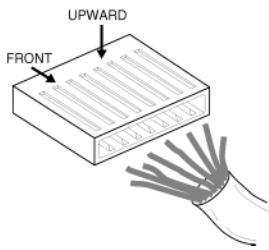

PT-0588-50UL

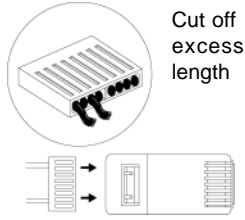

RJ-45 Plugs

110 TYPE PATCH PLUGS

- PT-110PP1 CAT 5, 1 Pair Type
- PT-110PP2 CAT 5, 2 Pair Type
- PT-110PP3 CAT 5, 3 Pair Type
- PT-110PP4 CAT 5, 4 Pair Type

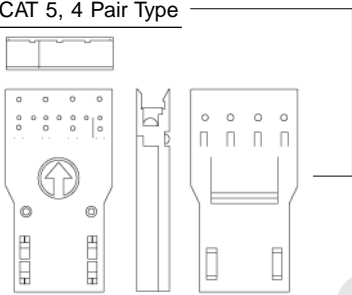

SHIELDED CAT 5

- PTS-0588-50UL CAT 5 Modular Plug 8P8C
- PTS-0510-50UL CAT 5 Modular Plug 10P10C
50m" Gold UL



REGULAR TYPE

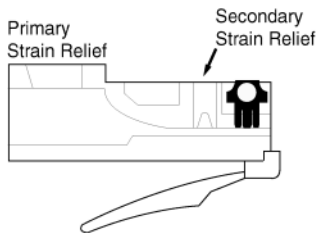

AMP TYPE

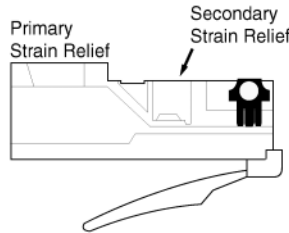

HALF SHIELDED PLUG

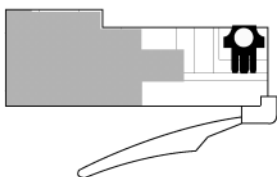

FULL SHIELDED PLUG

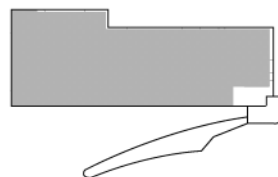

■ Metal shield wraps around the plug body

See pages 35 & 36 for detail information on Tools

CAT 6 PLUGS

- Exclusive Staggered Plug to Ensure CAT 6 High Performance
- Polycarbonate, RJ-45 plug
- Staggered alignment termination
- 50µ" gold plated contacts, plug geometry meets FCC 68.500 and IEC 60603-7 specifications for modular plugs.



PT-0688-50UL



CAT 5e PLUGS

PT-05E88-50UL



BOOTS

- Makes Connections Color Coded
- Boots Strain Relief Allows a Large Bend Radius, Necessary to Achieve Cat 5 Performance on Level 5 Connections
- Different Inside Diameters for Different Cable O.D.

PTC-RJ45-F (CC)	CC: BK, GR	For flat cables
PTC-RJ45-50 (CC)	CC: BK, GR	5.0 mm I.D.
PTC-RJ45-55 (CC)	CC: BG, BK, BL, GN, GR, OR, RD, WH, YW	5.5 mm I.D.
PTC-RJ45-60 (CC)	CC: BK, BL, GN, GR, IV, OR, PK, RD, VL, WH, YW	6.0 mm I.D.
PTC-RJ45-65 (CC)	CC: BK, GR	6.5 mm I.D.



PTC-RJ45



Boot Attached on Mod Plug

SNAP ON BOOTS

FOR BOOTS AND SNAP-ON BOOTS



PTC-SNP45-RD

PTC-SNP11-(CC) For RJ-11

PTC-SNP45-(CC) For RJ-45

Colors Chart (CC)	Black (BK)	Blue (BL)	Green (GN)	Gray (GR)	Ivory (IV)	Orange (OR)
	Pink (PK)	Red (RD)	Violet (VL)	Yellow (YW)	White (WH)	

SHIELDED PLUGS



All RJ 45 8P8C

PTS-088-S1	Metalized Shield, Regular Die
PTS-088R-50UL	2 Prong, Regular Die
PTS-0388R-50UL	3 Prong, Regular Die
PTS-03A88R	3 Prong, Half Shield, AMP Type Die
PTS-03A88R-50UL	3 Prong, Half Shield, AMP Type Die
PTS-03AW88R	3 Prong, Whole Shield, AMP Type Die
PTS-03AW88R-50UL	3 Prong, Whole Shield, AMP Type Die
PTS-03AW88	3 Prong, Whole Shield, AMP Type Die
PTS-0A88R-50UL	8P8C Shield Twist Pair Stranded



MODULAR COMPONENTS

Wiring Configurations

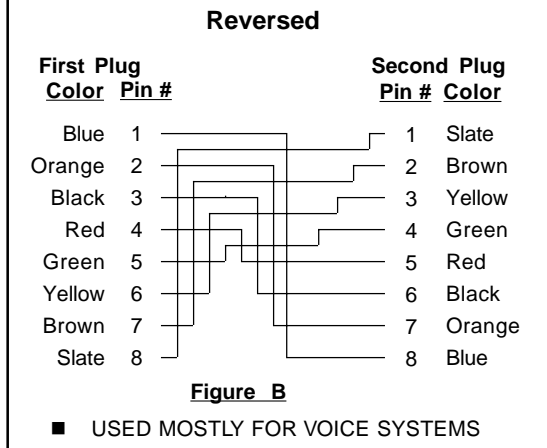

SCREW TYPE MOUNTING BLOCKS, SNAP ON TOP

- Single Jack, Snap Covers
- Double Sided Sticker
- Mounting Screws
- Gold Plated Contacts
- Both UL & Standard Parts
- Wiring: 6P4C & 6P6C -- USOC
- 8P8C -- AT &T



PT-108B-4C

PT-108-4C	6p4c SCREW LOCKS
PT-108A-4C	6p4c Jacks
PT-108A-6C	6p6c Jacks
PT-108A-6D	W/DEC Jack
PT-108A-8C	8p8c Jacks
PT-108B-4C	6p4c Jacks (Economy Block)
PT-108A-8C-SB	8p8c w/ Shorting Bar

Non-UL Listed

TELEPHONE CORDS

- Silver Satin or Ivory Color
- Modular Line Cords
- Reversed Wiring
- Available Footage=LL



PT-504X-(LL)SV

PT-504X-3SV		
PT-504X-(LL)IV	RJ 11, 4C	LL=7, 14, 25
PT-504X-(LL)SV		LL=7, 14, 25
PT-506X-(LL)IV	RJ 11, 6C	LL=7, 14
PT-506X-(LL)SV		LL=7, 14, 25
PT-508X-(LL)IV	RJ 45, 8C	LL=7
PT-508X-(LL)SV		LL=7, 14, 25

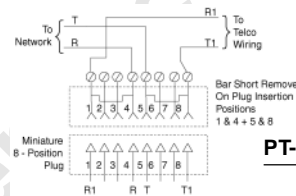

PT-108A-8C-SB

PT-108A-4C-UL	6p4c Jacks
PT-108A-4CWH-UL	RJ 11, 4C, White
PT-108A-6C-UL	6p6c Jacks
PT-108A-6D-UL	W/DEC Jack
PT-108A-6CWH-UL	RJ 11, 6C, White
PT-108A-8C-UL	8p8c Jacks
PT-108A-8CWH-UL	RJ 45, White



DUPLEX JACKS

- Ivory Color
- Gold Plated Contacts
- Split one line into two

PHONE (CROSS WIRING)

PT-101J-422	4 in 2&2 out L1+L2
PT-101J-444	3 6p4c Jacks
PT-101J-666	3 6p6c Jacks
PT-101J-888	3 8p8c Jacks



DATA (STRAIGHT THRU WIRING)

DC-101J-666	3 6p6c Jacks
DC-101J-888	3 8p8c Jacks

SCREW TYPE MOUNTING BLOCKS, DUAL JACKS

- Dual Jacks, Screw-on Cover
- Double Sided Sticker
- Screw Contacts
- Screws for Mounting
- Gold Plated Contacts
- Ivory Color
- Wiring: 6P4C & 6P6C--USOC
- 8P8C-- AT &T



PT-1104A-44	2 6p4c Jacks
PT-1104A-66	2 6p6c Jacks
PT-1104A-88	2 8p8c Jacks

PT-1104A-44-WH	2 6p4c Jacks
PT-1104A-88-WH	2 8p8c Jacks

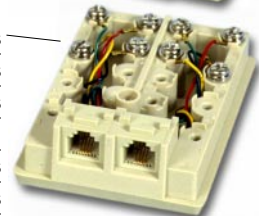

DUPLEX ADAPTORS

- Ivory Color
- Gold Plated Contact
- Split One Line into Two

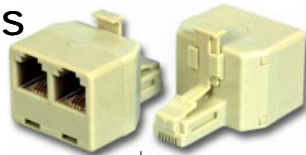

PT-101-422	4 in 2&2 out L1+L2
PT-101-444	6p4c Plug, 2 6p4c Jacks
PT-101-666	6p6c Plug, 2 6p6c Jacks
PT-101-888	8p8c Plug, 2 8p8c Jacks
PT-101-448	6p4c Plug, 1 6p4c Jacks, 1 8p8c Jacks

SURFACE JACK COVER

PT-109-4C Surface Jack Cover

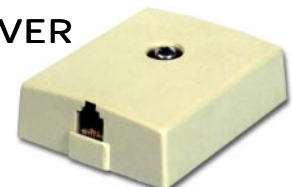

MODULAR ACCESSORIES



COIL HANDSET CORD

- Available Colors: BK, IV, WH

PT-604-07'

PT-604-12'

PT-604-18'

PT-604-25'



EXTENSION

- Modular Cords w/ Spaded Ends
- SV= Silver Satin

PT-404-7' RJ 11

PT-404-15' RJ11

PT-404-25' RJ11

PT-408-7'SV RJ45



MODULAR SURFACE JACK

- Ivory Wall Jack Covers

PT-107-4C



Duplex Jack

PT-204-15'

PT-204-25'



Single Jack

PT-304-15'

PT-304-25'



SMOOTH SURFACE WALL PLATE

- Smooth Surface Wall Plates w/ 6p4c Jack(s), Ivory

PT-103B-4C Single

PT-104B-44 Dual



DECORA WALL PLATE

- Decora Wall Plates w/ 6p4c Jack(s), Ivory

PT-103D-4C Single

PT-104D-44 Dual



CIRCULAR PLATE

- Ivory Circular Wall Jack Plates

PT-105-4C

PT-105-6C



WALL OUTLET FOR PHONE MOUNTING

- Ivory Wall Phone Mount Plate

PT-106-4C

PT-106-6C



- Ivory Wall Wall Mounting Plate w/ Dual Jack On the Side

PT-106D-4C

PT-106D-6C



MODULAR & VIDEO JACK WALL PLATE

- Wall Plates w/ 6p4c Jack and TV Antenna Jack, Ivory

PT-104B-F4C



SINGLE & DUAL MODULAR JACK WALL PLATES

- Single Jack, Single Gang Plastic Wall Plate
- Ivory Color, Screw Terminal
- Gold Plate Contacts
- See Index for Wiring Color Code



PT-103-4U 6P4C, USOC

PT-103-6U 6P6C, USOC

PT-103-8U 8P8C, USOC

PT-103-8A 8P8C, AT&T

PT-103-8AK 8P8C, AT&T Keyed

PT-103-6NW 6P6C Nevada Western

PT-103-10C 10P10C, W/Key

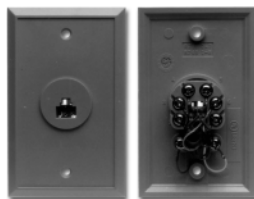

PT-103-8U/UL

- Dual Jack, Single Gang Plastic Wall Plate
- Gold Plated Contacts, Screw Terminals
- See Index for Wiring Color Code



PT-104-10C 2 10P10C

PT-104-44U 2 6P4C, USOC

PT-104-66U 2 6P6C, USOC

PT-104-88A 2 8P8C, AT&T

PT-104-8AKK 2 8P8C Keyed, AT&T

PT-104-6DD 2 6DEC Type

PT-104-66NW 2 6P6C Nevada Western



PT-104-68A-UL

PT-103-4U/UL 6P4C, USOC

PT-103-6U/UL 6P6C, USOC

PT-103-8U/UL 8P8C, USOC

PT-103-8A/UL 8P8C, AT&T

PT-103-8AK/UL 8P8C, Keyed, AT&T

PT-103-6D/UL 6 DEC Type

PT-104-44U-UL 2 6P4C, USOC

PT-104-66U-UL 2 6P6C, USOC

PT-104-68A-UL 2 6P6C, 2 8P8C

PT-104-88A-UL 2 8P8C, AT&T

PT-104-8AKK-UL 2 8P8C Keyed, AT&T



MODULAR WALL PLATES & JACKS

110 TYPE MOUNTING BLOCKS, SINGLE & DOUBLE JACK

- Single Jack, Screw-on Cover
- Comes w/ Double Sided Sticker and Mounting Screws
- Gold Plated Contacts
- 110 Type IDC Termination with 2 Pair Caps
- Wiring: 6P4C & 6P6C -- USOC 8P8C -- AT&T



PT-1103-6C

PT-1103-4C	RJ11, 4C
PT-1103-6C	RJ11, 6C
PT-1103-6DEC	DEC Type Jack
PT-1103-8C	RJ45 Regular
PT-1103-8CK	RJKeyed

PT-1103-4/UL	RJ11, 4C
PT-1103-6/UL	RJ11, 6C
PT-1103-6DEC/UL	Dec Type Jack
PT-1103-8/UL	RJ45 Regular
PT-1103-8K/UL	RJ45 Keyed



- Double Jack, Screw-on Cover
- Comes w/ Double Sided Sticker & Mounting Screws
- Gold Plated Contacts
- 110 Type IDC Termination with 2 Pair Caps



PT-1104B-88

PT-1104B-44	2 RJ11, 4C
PT-1104B-66	2 RJ11, 6C
PT-1104B-6DD	IDC6DEC Dual Surf.
PT-1104B-88	2 RJ45, Regular
PT-1104B-88K	2 RJ45, One Keyed Port
PT-1104B-8KK	2 RJ45, Dual Keyed Port

PT-1104B-44/UL	2 RJ11, 4C
PT-1104B-66/UL	2 RJ11, 6C
PT-1104B-68K/UL	1 RJ11, 1RJ45 Keyed
PT-1104B-88/UL	2 RJ45, Regular
PT-1104B-88K/UL	2 RJ45,
PT-1104B-6DD/UL	One Keyed Port 2 DEC Type
PT-1104B-66D/UL	Dual Port



110 TYPE SINGLE WALL JACKS

- Single Jack Plastic Fittings for PT-113C-UL Wall Plates
- UL Listed, Gold Plated Contacts
- 110 Type Termination
- Wiring: 6P4C & 6P6C -- USOC 8P8C -- AT&T
- Copy of wiring code included



PT-113-4C-UL	6P4C, USOC
PT-113-6C-UL	6P6C, USOC
PT-113-6D-UL	6 DEC Type
PT-113-8C-UL	8P8C, AT&T
PT-113-8CK-UL	8P8C Keyed, AT&T



PT-113-4C-UL

110 TYPE DUAL WALL JACK

- Double Jack Plastic Fitting for PT-114C-UL Wall Plates
- UL Listed, Gold Plated Contacts
- 110 Type Termination
- Wiring: 6P4C & 6P6C -- USOC 8P8C -- AT&T



PT-114-44-UL	2 6P4C, USOC
PT-114-66-UL	2 6P6C, USOC
PT-114-6DD-UL	2 6-DEC Type
PT-114-68K-UL	1 6P6C Voice, 1 8P8C, AT&T
PT-114-88-UL	2 8P8C, AT&T
PT-114-88K-UL	1 8P8C Voice, 1 8P8C Data Both AT&T
PT-114-8KK-UL	2 8P8C Keyed, AT&T



PT-114-44-UL

PLASTIC WALL PLATES

- Single or Dual Hole, Single Gang Wall Plates
- UL Listed, copy of wiring code included
- Single Gang Box or PT-115BUL Type Box



PT-113C-UL	Single Hole Wall Plate
PT-114C-UL	Dual Hole Wall Plate

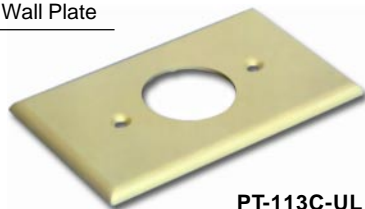

PT-113C-UL

PLASTIC WALL BOXES

- For Single, Dual Hole or Any Single Gang Wall Plates
- UL Listed
- Three different depth for different fitting, See Figures Below
- Use PT-115B Boxes for PT-113 and PT-114 type jacks



PT-115-UL	Ivory, 7/8" Deep
PT-115B-UL-IV	Ivory, 1 3/4" Deep
PT-115B-UL-WH	White, 1 3/4" Deep

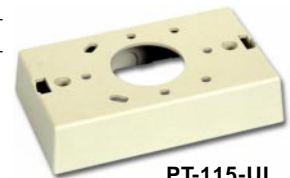

PT-115-UL



LAN COMPONENTS

ATP CONNECTOR

- HP Type D-Sub Connector

ATP-3HP	HP Typed D-sub 3 pin plug (male)
ATP-3HS	HP Typed D-sub 3 pin socket (female)
ATP-5HP	HP Typed D-sub 5 pin plug (male)
ATP-5HS	HP Typed D-sub 5 pin socket (female)

ATP-FUNNEL



ATP-5HS

ATP-FUNNEL

ATP MODULAR ADAPTOR KITS

- ATP Connector with RJ Jack
- Gold Plated Contact Pins
- Used on HP Systems

ATP-3MT6	ATP Plug to RJ-11 Kit
ATP-3MT8	ATP Plug to RJ-45 Kit
ATP-5MT6	ATP Plug to RJ-11 Kit
ATP-5MT8	ATP Plug to RJ-45 Kit

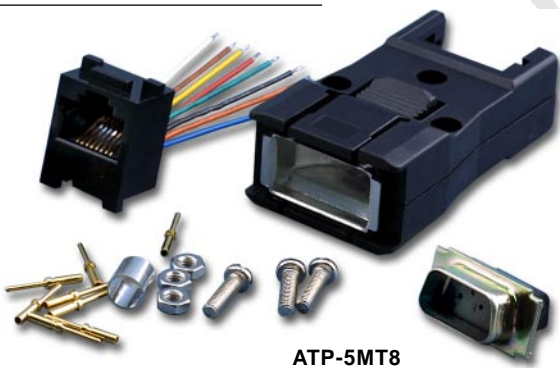

ATP-5MT8

TWINAX STRAP & T ASSEMBLIES

- Use on IBM System/3X Computer W/52XX Terminal & Control Units
- Choice of either DB9, DB15 or Twinax Device Connection
- **Self Termination** Assembly assures Signal (data) Connection integrity while disconnecting.

DC-TA707A/CO	Twinax Device Connection, Color Monitor
DC-TA707A/M	Twinax Device Connection, Monochrome Monitor
DC-TA709A/15	DB15 Device Connection
DC-TA709A/9	DB9 Device Connection



DC-TA707A/9

ATP CONNECTOR KITS

- D-Sub 9position Shell with 3 or 5 contacts.
- Gold Plated Crimping Pin
- Used on HP Systems and Connections

ATP-KIT-3P	ATP Plug Kit, 3C
ATP-KIT-3S	ATP Socket Kit, 3C
ATP-KIT-5P	ATP Plug Kit, 5C
ATP-KIT-5S	ATP Socket Kit, 5C

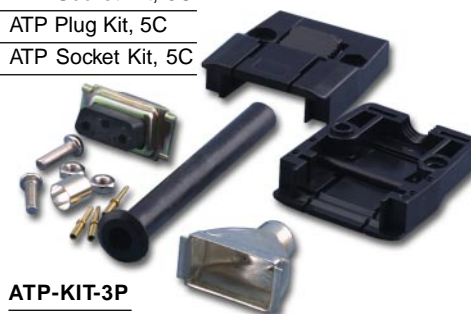

ATP-KIT-3P

IBM SURFACE BOXES & FACE PLATES

- Surface Mount Boxes for Data and/ or Keystone Connectors
- Choice of Data Connectors See Pgs. 26, 27

WP-IBM-1P	Type 1 Face plate (IBM#8310572)
WP-IBM-2P	Type 2 Face plate (IBM#6091025)
WP-IBM-3P	Face plate W/ 2 Keystone Holes
WP-IBM-3M	Surface Box with magnet for Face plates
WP-IBM-4M	Surface Box with magnet, for Face plates



WP-IBM-1P



WP-IBM-4M



LAN COMPONENTS

- For IBM's Token Ring Networks
- Both Type A (AMP) and Type B (T&B) are Available
- Gold Plated Contacts, 4 Color Coded, Self Shorting Termination
- All UL Listed

DC-M-1M	(AMP554000-1); 45°, 180° & 90° Cable Exit IBM Type A
DC-M-1M4	(AMP554000-4) 180° Cable Exit only
DC-M-1M-T&B	Thomas & Betts 037-600-04-1; IBM Type B
DC-M-1M-TW	U.S. Patent # 5088934, Economy Imported Version

- **Impedance Matching Baluns:** Matches 150 Ohm Shielded Twisted Pair Cable to 105 Ohm Unshielded Twisted Pair Cable.
- **Wiring Matching Adaptors:** Matches Unshielded Twisted Pair Wiring to Typical Applications Wirings, Includes IBM 3270 and 10 Base T
- Gold Plated Contacts.
- Custom Wiring Available, Please Call.



DC-MD-8C-1



DC-M-1M-4

Part No.	MOD Jack	Data Connector				Notes
		Black	ORG	GRN	RED	
DC-MD-4C	RJ-11	2	5	4	3	
DC-MD-6C	RJ-11	2	5	4	3	1, 6 Ground
DC-1D-70-11						
DC-MD-8C-1	RJ-45	2	1	5	4	3,6 Gnd; 7,8 NC
DC-1D-71-45						
DC-MD-8C-2	RJ-45	3	6	5	4	1,2 Gnd; 7, 8 NC
DC-1D-72-45						
DC-MD-8C-3	RJ-45	6	3	2	1	4, 5, 7, 8: NC
DC-1D-73-45						

Balun: A device used to connect a **BAL**anced Line (typically Twisted Pair Cables) and an **UN**balanced Line (typically Coax Cables).

- Baluns are used to substitute for Coax and are usually used in pairs.
- **Transmission Distance :** Generally effective up to 1000ft (330m) on 22/24 AWG twisted pair cables. Some up to 2400ft (700m) see notes below.

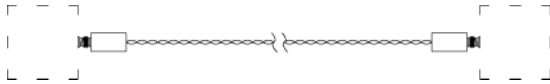

DC-1C-34

Figure	Part #	Coax Connector	Modular Jack		Wiring Type	Approx. Dimension (L x W x H)
			Style	Signal / Ground		
A, J4	DC-1A-34	BNC Male	RJ11	3; 4	IBM	2" x 0.9" x 1"
A, J3	DC-1ATH45-45***	BNC Male	RJ11	3; 4	NOVELL	2" x 0.9" x 1"
A, J4	DC-1A-43G	BNC Male	RJ11	4; 3	IBM	2" x 0.9" x 1"
A, J3	DC-1A45-45	BNC Male	RJ45	4; 5	IBM	2" x 0.9" x 1.1"
A, J1	DC-1A45-2178	BNC Male	RJ45	2; 1		2" x 0.9" x 1.1"
A, J2	DC-1A-25	BNC Male	RJ11	2; 5	ROLM	2" x 0.9" x 1"
B, J4	DC-1AM-34	BNC Male	RJ11**	3; 4	IBM	1.4" x 0.8" x 1"
C	DC-1AS	BNC Male	None*	None*	-- --	1.1" x 0.6" x 0.7"
A, J5	DC-1A-DEC	BNC Male	DEC	1; 3	DEC	2" x 0.9" x 1"
D, J4	DC-1AP-34	BNC Male With "Pigtail"	RJ11	3; 4	IBM	2" x 0.9" x 1"
D, J3	DC-1AP-45-45	BNC Male With "Pigtail"	RJ45	4; 5	IBM	2" x 0.9" x 1"
D, J4	DC-1ASP-34®	BNC Male, Super Balun	RJ11	3; 4	IBM	2" x 0.9" x 1"
E, J4	DC-1B-34	BNC Female	RJ11	3; 4	IBM	2" x 0.8" x 1"
F, J2	DC-1C-25	Twinax Male	RJ11	2; 5	ROLM	2" x 0.9" x 1"
F, J4	DC-1C-34	Twinax Male	RJ11	3; 4	IBM	2" x 0.9" x 1.1"
F, J3	DC-1C45-45	Twinax Male	RJ45	5; 4	IBM	2" x 0.9" x 1.1"
N/A, J4	DC-1CP-34	Twinax Male	RJ11	3; 4	IBM	2" x 0.9" x 1.1"
N/A, J4	DC-1CSP-34®	Twinax Male, Super Balun	RJ11	3; 4	IBM	2" x 0.9" x 1.1"
N/A	DC-IIAP	BNC & TNC Male, W/"Pigtail"	RJ11	2, 3; 4, 5	NWS	2" x 0.9" x 1"

Note : All baluns include both screw tap and modular jack unless otherwise noted.

- * -- Screw Tap Only
- ** -- Modular Jack Only
- *** -- Characteristic Impedence on Coax Side : 50 Ω
- @ -- **Super Balun** Transmission Distance of up to 2400 ft (700m)



LEGACY LAN COMPONENTS

DATA BALUNS

- Red Baluns: Compatible with IBM Type Red Baluns.
- Yellow Baluns: Compatible with IBM Type Yellow Baluns.
- Blue Baluns: For Thin-Net, 10 Base 2
- Green Balun: For IBM System/3X, AS/400; Twin-Ax
- Available W/Single or Dual BNC Configuration
- Impedance Matching Between Coax Signal and 150 ohm Shielded Twisted Pair Signal

Red Balun for IBM 3278 (Category A)

DC-1D-10-RD	D.C. to Single BNC, Compact Version
DC-1D-11-RD	D.C. to Single BNC, IBM 6339082
DC-1D-12-RD	D.C. to Dual BNC, IBM 6339083

Yellow Balun for IBM 3277 (Category B)

DC-1D-20-YW	D.C. to Single BNC, Compact Version
DC-1D-21-YW	Data Connector to Single BNC
DC-1D-22-YW	Data Connector to Dual BNC

Blue Balun for Thin net (10 Base 2)

DC-1D-31-BLU	Data Connector to Single BNC
---------------------	-------------------------------------

Green Balun for IBM System/3X, AX/400

DC-1D-51-GRN	Data Connector to Twin-Ax Connector
DC-1D-51B-GN	Data Connector to Twin-Ax Female

Wang Balun (BNC/TNC)

DC-1D-42-WNG	Data Connector with BNC/TNC Adaptor
---------------------	-------------------------------------

*D.C.=Data Connector

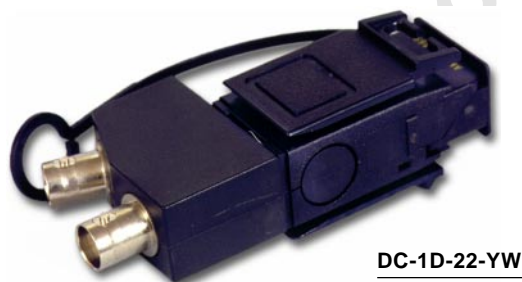

DC-1D-22-YW

IMPEDANCE MATCHING ADAPTOR

- Save time and effort by allowing the used of existing Coaxial Cables on Networks that requires different Impedance, i.e. setting up Ethernet(50W) over existing ARCnet Cables(93W), by matching the impedance.
- BNC Jack to Jack Configuration
- Metal Enclosure with Impedance Marking for Cable to Devices Matching

DC-B93F2F50



DATA CABLE ASSEMBLY

DC-M2-8'	Data Connector Patch Cable,8ft (IBM#8642551)
DC-M/D9-8'	Data Connector to DB9 Cable,8ft (IBM#6339098)
DC-M-BNC-8'	Data Connector to BNC Cable,8ft
DC-M-BNC2-8'	Data Connector to 2 BNC Cable,8ft
DC-M-DPC-8'	Data Connector to Dual Purpose Connector 8ft(IBM#6339073)
DC-M-TWX-8'	Data Connector to Twinax Cable,8ft (IBM#6091075)

* *Special Lengths Available, Please Call*



DC-M-BNC-8'

MEDIA FILTERS

- Gold Plated Contacts, Both at D-Sub end & RJ-Jack end.
- Rugged Plastic Housing with Thumb Screw
- DB9 Male Connector to either RJ11 or RJ45 Jack.
- Allow IEEE 802.5 Toking Ring Device Operating at either 4 or 16 Mbps to be Connected to Unshielded Twist Pair (UTP) Cables
- Allow Transmission Distance of up to 1000 ft at 4 MHZ and 400 ft at 16 MHZ with level 4 UTP

DC-MF-9MT6	DB9 Male to RJ11, 6c Jack
DC-MF-9MT8	DB9 Male to RJ45, 8c Jack



DC-MF-9MT8



LEGACY LAN COMPONENTS

NETWORKING KITS

- Apple Talk® or Apple Phonet® Compatible Kit.
- Additional Mini Din Cable, Modular Cable and Mini Din Adaptor are Available.

DC-AP-MAC	DB9 Connector & Mini Din 3 ports
DC-AP-MACPL	Mini Din 8 Connector & Mini Din 3 ports
DC-APM-MAC	DB9 Connector & Modular Jack (RJ11) ports

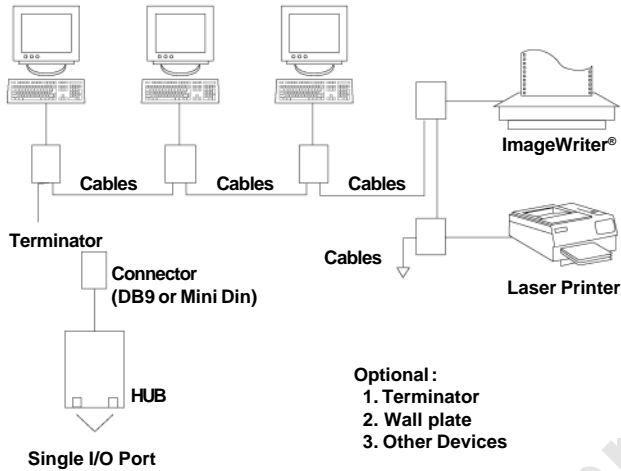

DUAL PURPOSE CONNECTOR

- Gold plated Center Contact
- Complete, Ready for assembly, with BNC like front end and Screw-In Strain Relief

DC-DPC



COAX MULTIPLEXER

- For Cable Total Lengths not exceeding 5000ft. (1500m)
- Use RG62/U 93ohm Coax Cable
- 2 Ports on IBM3274

DC-3A Panel Mount Type
DC-3A1



ARCNET PASSIVE HUBS

- Use as the Center of the Star Configuration in Arcnets
- Wall Mount Passive Hub available with a set of Mounting Screws and a 93W Terminator

DC-10A-1	Wall Mount unit, See Notes Above
DC-10A-2	Compact unit, Molded, Black
BNC-3063	93 W Terminator 1/2W, 5%
BNC-3063-1	93 W Terminator 1/2W, 1%
BNC-3063-2	93 W Terminator 1/2W, 1% w/ Grounding Chain

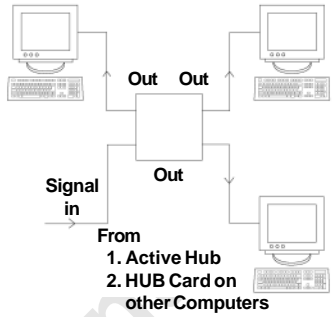

V.35 CONNECTORS

- Metal Shell, Plastic Housing
- Connectors used on High Speed Transmission Devices

V35-HA	V DOT 35 Crimp Housing (Both M & F)
V35-S-HP	Connector Hood and Male Housing Set, Pins Not Included
V35-S-HS	Connector Hood and Female Housing Set, Pins Not Included
V35-SH	Metal Connector Hood Only
V35-HP	Male Housing
V35-HS	Female Housing
V35-P/F	Female Pin, Gold Plated, Machine Type
V35-P/F-20AWG	Female Crimp Pins
V35-P/F-STMP	V DOT 35 Female Crimp Pin Stamped
V35-P/M	Male Pin, Gold Plated, Machine Type
V35-P/M-STMP	Male Crimp Pin Stamped on the Reel
V35-SCRSET	Screws (Set of Two) Only

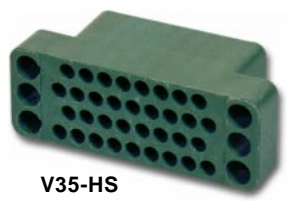
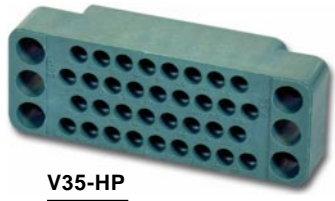

TOOLS FOR V.35

PHT-V35-CMP	Ratchet Crimp tool for 14-22 AWG
PHT-V35-XTR/F	Female Pin Extractor
PHT-V35-XTR/M	Male pin Extractor

SEE PAGE 36 TOOLS



POWER STRIPS & PANEL RACKS

SURGE PROTECTED POWER STRIPS

Power strip with **Circuit Breaker**. Fire retardent plastic cover with **Six Grounded Outlets (7 Outlets on 7Ps)**. **Reset Button** and **4ft.(PS-PSPP-6P)** or **6ft.(PS-PSPP-6P6 & PS-PSPP-7P)** **Power Cord**. **3 MOV Full Surge Protection** and **EMI/RFI**. (**PS-PSPP-7P** only)Protect equipment from electrical spikes and power surges. **UL** and **CSA** Listed.

- Electrical Rating: 125 V, 15 A, 1875Watts
- Clamping Voltage: 400 V (500 V pm 7Ps)
- Current Peak: 4000 A
- Response Time: 7 ~ 12 nanoseconds
- Energy Absorption: 50/150 Joules
- Power Cord: 14 AWG, UL SJT

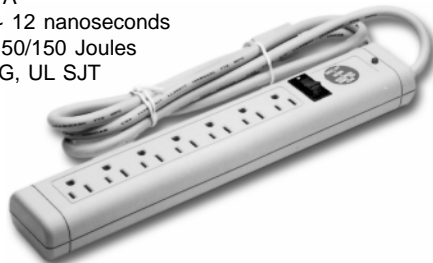

PS-PSPP-7P Plastic Casing, 7 Outlet Ports

PS-PSPP-6P Plastic casing, 4 ft. cord

PS-PSPP-6P6 Plastic Casing, 6 ft. cord



PS-PPAD-5P 5 Ports, 5 Switches, Individual Control

Power strip with **Circuit Breaker**. **Enamel Metal** cover with **Six Grounded Outlets (5 on PS-PPAD-5P)**. **Reset Button** and **6ft** **Power Cord**. **3 MOV Full Surge Protection**, **Surge Protected Modem Jacks(PS-PERM-6P/M)**, **EMI/RFI Noise Filter** Protect equipment from electrical spikes and power surges. **UL** and **CSA** Listed.

- Electrical Rating: 125 V, 15 A, 1875Watts
- Clamping Voltage: 400 V (500 V on 5Ps)
- Current Peak: 4000 A (4500A on 5Ps)
- Response Time: 7 ~ 12 nanoseconds
- Energy Absorption: 50/150 Joules
- Power Cord: 14 AWG, UL SJT



PS-PERM-6P/M Enamel Metal Casing, Modem Jacks



PS-PSPM-6P Enamel Metal Casing

LOADED PANELS

	High	Ports	Components Part No.	REMARK/NOTES
WPK-25HS/T-24	2U	24	DH-25HS/T	
WPK-B3191-16A	1U	16	BNC-3191	
WPK-B3191-16B	2U	16	BNC-3191	
WPK-B3191-24	2U	24	BNC-3191	
WPK-B3191-2X8	2U	16	BNC-3191	Dual Row 8 Ports Each Row
WPK-B3191-32	2U	32	BNC-3191	
WPK-B3192-16A	1U	16	BNC-3192	
WPK-B3192-16B	2U	16	BNC-3192	
WPK-B3192-24	2U	24	BNC-3192	
WPK-B3192-32	2U	32	BNC-3192	
WPK-B3193-16A	1U	16	BNC-3193	
WPK-B3193-24	2U	24	BNC-3193	
WPK-B3193-32	2U	32	BNC-3193	
WPK-J10218-32	2U	32	DC-1021-8C-BK	
WPK-LGC25FF16-B	2U	16	AD-LGC-25FF	
WPK-WANG-32	2U	32	BNC-3192/TNC-3461	

RACKS

WRP-RACK Grey Hammertone finish,
Mounting Rails Drilled & Tapped

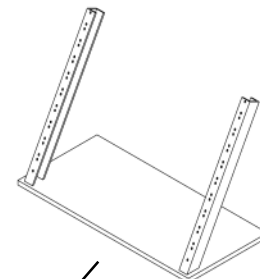
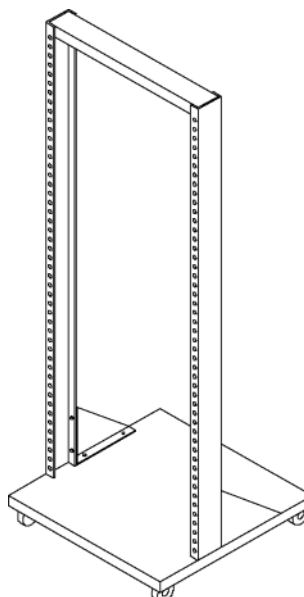

WRP-RACK-TT

Table Top, Mounting Rails
Drilled & Tapped



STAINLESS STEEL WALL PLATES

Single Gang

WP-9-(XX)H	For DB9
WP-15-(XX)H	For DB15
WP-25-(XX)H	For DB25

(XX) indicates No. of Holes: 1, 2

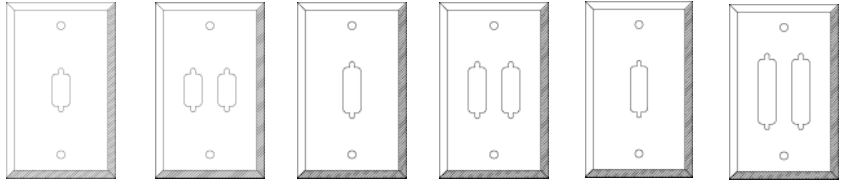

WP-9-1H **WP-9-2H** **WP-15-1H** **WP-15-2H** **WP-25-1H** **WP-25-2H**

WP-25/TW	For DB25, Twinax, 1 Hole
WP-25/C	For DB25, Coax 1/2" dia.
WP-25M	For DB25, Keystone Jack
WP-25T/11	
WP-36-1H	For Centronics 36, 1 Hole

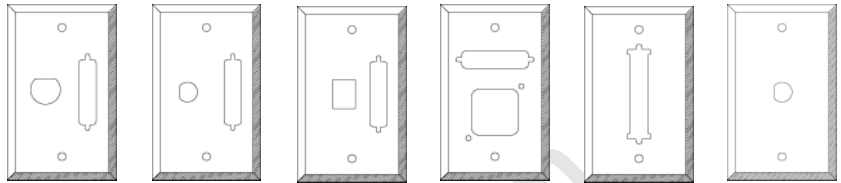

WP-25/TW **WP-25C** **WP-25M** **WP-25T/11** **WP-36-1H** **WP-C-1H**

WP-C-(XX)H	For Coax FeedThru, 1/2" dia.
WP-C-(XX)H3/8	For Coax, 3/8" dia.
WP-C/M	For Keystone Jack and Coax, 1/2" dia.
WP-IBM-1	For Data Connector
WP-IBM/C	For Data & Coax

(XX) indicates No. of Holes: 1, 2

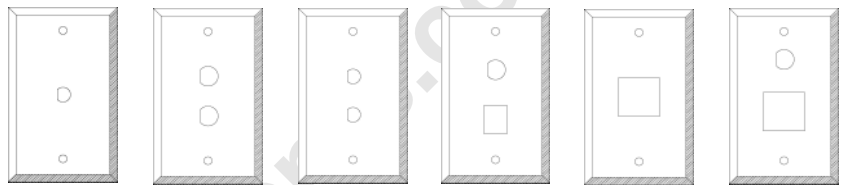

WP-C-1H 3/8 **WP-C-2H** **WP-C-2H 3/8** **WP-C/M** **WP-IBM-1** **WP-IBM/C**

WP-IBM/M	For Data Connector, Keystone Jack 1 Hole
WP-M-(XX)H	For Keystone Jack
(XX) indicates No. of Holes: 1, 2, 3, 4, 6	
WP-TW-(XX)H	For Twinax
(XX) indicates No. of Holes: 1, 2	
WPS	Blank Plate, Single Gang

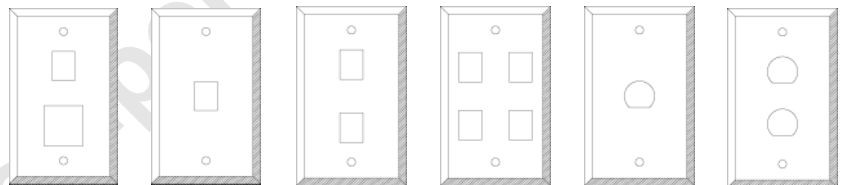

WP-IBM/M **WP-M-1H** **WP-M-2H** **WP-M-4H** **WP-TW-1H** **WP-TW-2H**

Double Gang

WP-15-1HD	For DB15, 1 Hole
WP-25-2HD	For DB25, 2 Holes
WP-25-4HD	For DB25, 4 Holes
WP-37-1HD	For DB3, Dual Gang, 1 Hole

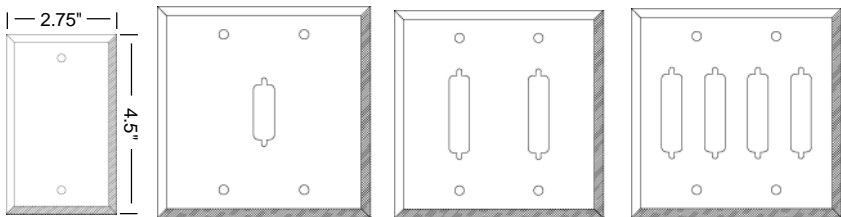

WPS **WP-15-1HD** **WP-25-2HD** **WP-25-4HD**

WP-25MD	For DB25 1 Hole, 2 Keystone, 2 Hole
WP-C-2HD	For Coax, 1/2" DIA, 2 Holes
WP-M-4D	For Keystone Jack, 4 Holes
WPD	Blank Plate, Double Gang

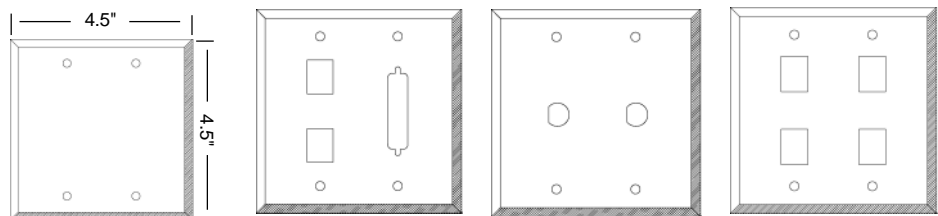

WPD **WP-25MD** **WP-C-2HD** **WP-M-4D**

For Universal Fitting
(See Page 14 For Modular Frame)

WP-MA-2	Dual Port
WP-MA-4D	Quad Port, Double Gang

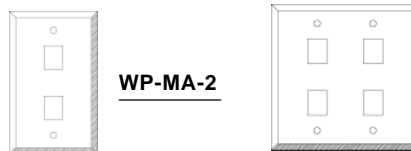

WP-MA-2 **WP-MA-4D**

19" RACK MOUNT PANELS



ORDER INFO.

FOR D-SUB

WRP-09-16	16 Port, For DB9, 3.5" X 19"(2U)
WRP-09-32/3U	32 Port, For DB9, 5.25" X 19"(3U)
WRP-15-16	16 Port, For DB15, 3.5" X 19"(2U)
WRP-25-16	16 Port, For DB25, 3.5" X 19"(2U)
WRP-25-32/4U	32 Port, For DB25, 7" X 19"(4U)
WRP-37-16	16 Port, For DB37, 3.5" X 19"(2U)
WRP-D50-16	16 Port, For DB50, 3.5" X 19"(2U)

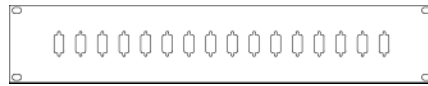

WRP-09-16

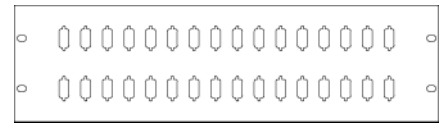

WRP-09-32/3U

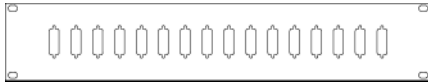

WRP-15-16

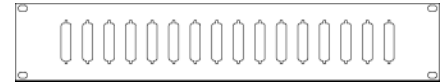

WRP-25-16

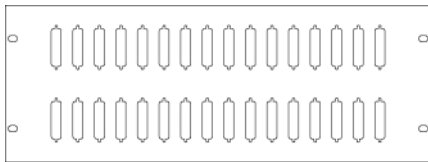

WRP-25-32/4U

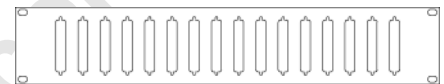

WRP-37-16

COAX

WRP-C-16 3/8"	16 Port, Coax For 3/8" dia. 3.5" X 19"(2U)
WRP-C-16/1U	16 Port, Coax, For 1/2" dia. 1.75" X19"(1U)
WRP-C-16	16 Port, Coax, For 1/2" dia. 3.5" X 19"(2U)
WRP-C-24	24 Port, Coax, For 1/2" dia. 3.5" X 19"(2U)
WRP-C-24 3/8"	24 Port, Coax For 3/8" dia. 3.5" X 19"(2U)
WRP-C-32	32 Port, Coax, For 1/2" dia. 3.5" X19"(2U)
WRP-C-32 3/8"	32 Port, Coax, For 3/8" dia. 3.5" X 19"(2U)

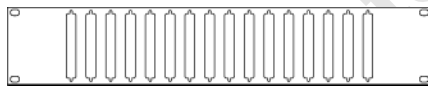

WRP-D50-16



WRP-C-16 3/8"



WRP-C-16/1U



WRP-C-16



WRP-C-24



WRP-C-24 3/8"

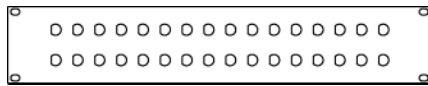

WRP-C-32

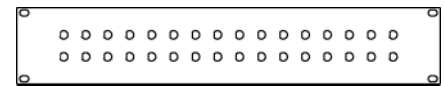

WRP-C-32 3/8"

2 ROWS OF 8 PORTS

WRP-C-2X8	16 Port, 3.5" X 19"(2U)
WRP-C-2X8 3/8"	6 Port, For 3/8", 3.5" X 19" (2U)



WRP-C-2X8



WRP-C-2X8 3/8"

DATA CONNECTOR

WRP-IBM-12	12 Port, Data Connector, 3.5" X 19"(2U)
WRP-IBM-12/1U	12 Port, Data Connector, 1.75" X 19"(1U)
WRP-IBM-16/3U	12 Port, Data Connector, 5.25" x 19"(3U)



WRP-IBM-12



WRP-IBM-16/3U



19" RACK MOUNT PANELS

ORDER INFO.

DATA & VOICE

WRP-IBM/M-12 12 Port Set, Data & Voice,
3.5" X 19"(2U)

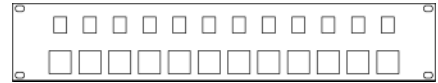

WRP-IBM/M-12

VOICE CONNECTOR

WRP-M-12/1U 12 Port, 1.75" X 19"(1U)



WRP-M-12/1U

WRP-M-12 12 Port, 3.5" X 19"(2U)

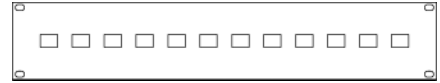

WRP-M-12

WRP-M-16/1U 16 Port, 1.75" X 19"(1U)



WRP-M-16/1U

WRP-M-16 16 Port, 3.5" X 19"(2U)



WRP-M-16

WRP-M-24 24 Port, 3.5" X 19"(2U)



WRP-M-24

WRP-M-32 32 Port, 3.5" X 19"(2U)



WRP-M-32

WRP-M-48 48 Port, 3.5" X 19"(2U)



WRP-M-48/3U

WRP-M-3X8 24 Port, 3.5" X 19"(2U)
3X8 port

WRP-M-36/3U 36 Port, 5.25" X 19"(3U)

WRP-M-48/3U 48 Port, 5.25" X 19"(3U)

WRP-M-48V/4U 48 Port, Vertical Hole,
7" X 19"(4U)

WRP-M-64/4U 64 Port, 7" X 19"(4U)



WRP-M-48/3U



WRP-M-64/4U

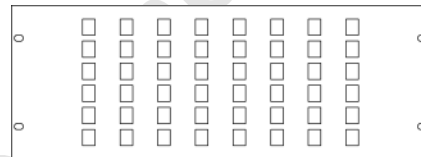

WRP-M-48V/4U

UV FITTING

WRP-MA-12/1U

WRP-MA-16/1U

WRP-MA-24

WRP-MA-32

(See Page 14 for Modular Frame)

FOR TWINAX

WRP-TW-16 16 Port, For Twinax,
3.5" X 19"(2U)

WRP-TW-24 24 Port, For Twinax,
3.5" X 19"(2U)

WRP-TW-32



WRP-MA-12/1U



WRP-MA-16/1U

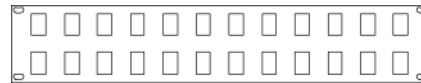

WRP-MA-24



WRP-MA-32



WRP-TW-16

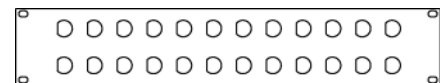

WRP-TW-24

BLANK PLATE

WRP-19/1.75 Blank plate, 1.75 X 19"

WRP-19/3.5 Blank plate, 3.5" X 19"



WRP-19/1.75



WRP-19/3.5

LOADED PANELS & WALL PLATES



BNC FEED THRU PLATE

- Screw Retaining Barrel Nut on Both Side
- Fitted w/ BNC FeedThru (See Pg.41)

<u>WPK-B3191-1</u>	<u>WPK-B3191-2D</u>
<u>WPK-B3192-1</u>	<u>WPK-B3192-2D</u>
<u>WPK-B3193-1</u>	<u>WPK-B3193-2D</u>
<u>WPK-B3191-2</u>	<u>WP-C-1H</u>
<u>WPK-B3192-2</u>	<u>WP-C-2H</u>
<u>WPK-B3193-2</u>	<u>WP-C-2HD</u>



WP-C-1H



WP-C-2H

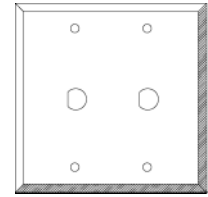

WP-C-2HD

TWINAX FEED THRU PLATE

- Screw Retaining Barrel Nut on Both Side
- Fitted w/ Twinax Feed Thru (See Pg.57)

<u>WPK-TW3502-1</u>	<u>WP-TW-1H</u>	<u>TWX-3502</u>
<u>WPK-TW3502-2</u>	<u>WP-TW-2H</u>	<u>TWX-3502</u>



WP-TW-1H



WP-TW-2H

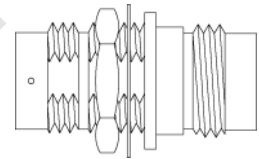

TWX-3502

D-SUB CONNECTORS

<u>WPK-09HS/T-(X)</u>	9 HST
<u>WPK-09P-2</u>	DS-9P 2 Holes
<u>WPK-25HS-2</u>	DH-25HS
<u>WPK-25HS/T-1</u>	DH-25HS/T
<u>WPK-25S-1</u>	Single Gang Wall Plate, DS-25S, one port

(X) Indicates No of Holes: 1, 2

KEYSTONE FEED THRU PLATE

WPK-M6C-25P/T Loaded Wall Plate with Keystone and DB25PP

WPH-103B-F-IV "F" Loaded Wall Plate (Ivory)

WPH-103B-F-WH "F" Loaded Wall Plate (White)

BNC SOLDER JACK

<u>WPK-B(XXX)-(HH)</u>
<u>BNC-(XXX)</u>
<u>WP-C-(HH) 3/8"</u>

XXX: 3194T, 7194T, 3194, 3195, 3196, 3199, 7194
No. of Holes in the Panel (HH): 16, 24, 32

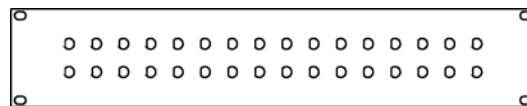

WP-C-32 3/8"

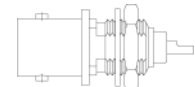

BNC-3195

BNC FEED THRU

<u>WPK-B319(XX)-(HH)</u>
<u>BNC-319(XX)</u>
<u>WP-C-(HH)</u>

(XX): 1, 2, 3
No. of Ports in the Panel: (HH) 16, 24, 32

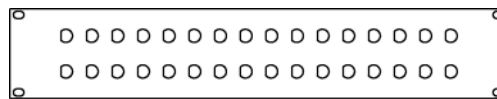

WP-C-32

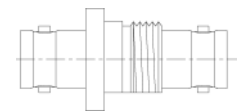

BNC-3191

TWINAX CONNECTOR

<u>WPK-TW350(XX)-(HH)</u>
<u>TWX-350(XX)</u>
<u>WP-TW-(HH)</u>

(XX): 2, 4
No. of Holes in the Panel: (HH): 16, 24

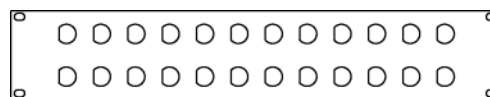

WP-TW-24

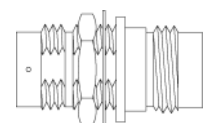

TWX-3502



PUNCH DOWN TOOLS FOR KEYSTONE

TOOL BODY

PHT-76-140

For "punching" solid conductor wires into terminal block or cut off short wire end after termination.

- Frame made with polyacepal resin and fiber glass.
- Impact pressure adjustable control: Turn the dial clockwise to **H** when inserting large wires, which indicate a pressure of 15 ± 2 Kg. Or turn to **L** for standard wires, with a pressure of 10 ± 2 Kg.
- Storage space at the backend of the handle for one extra blade.

PHT-76-240

With impact function but without impact pressure adjusting control.

PHT-76-340

Economic model, comes without impact function and impacting adjusting control.

PHT-76 series



BLADES

Blades made with SNCM-21 and hardened. All are interchangeable and reversable. Blades are easy to change without screwdriver.

BLADE	TERMINAL BLOCK
PHT-76-066	For use on 66 type
PHT-76-011	For use on 110 type
PHT-76-061	For both 66 & 110 type (no cutting blade)
PHT-76-0K	For use on krone type

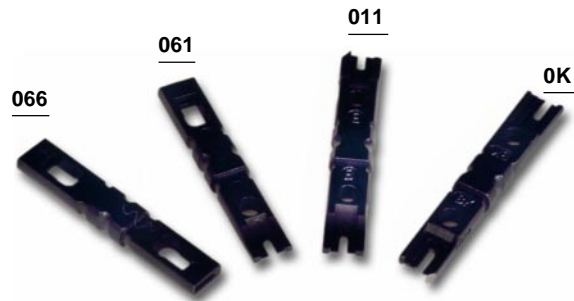

PHT-76 Series Blades

COMBINATIONS FOR BODIES AND BLADES

PHT-76-14 Series	PHT-76-24 Series	PHT-76-34 Series	Descriptions
PHT-76-140	PHT-76-240	PHT-76-340	Body only
PHT-76-1466	PHT-76-2466	PHT-76-3466	Body with blade PHT-76-066
PHT-76-1411	PHT-76-2411	PHT-76-3411	Body with blade PHT-76-011
PHT-76-1461	PHT-76-2461	PHT-76-3461	Body with blade PHT-76-061
PHT-76-14K	PHT-76-24K	PHT-76-34K	Body with blade PHT-76-0K



MODULAR CRIMPING TOOLS

8" PROFESSIONAL MODULAR CRIMPING TOOL

- Multi-functional, will crimp plugs designed for either solid or stranded conductors. Work with all standard plugs; including those manufactured by AMP, SS and AT&T licensed, etc.

- PHT-68-200 & PHT-68-201** are designed with 10 position punches for crimping 10p10c plugs or 8p8c plugs with cavities on the sides, such as the AMP 8P8C plugs. (see fig.1)

- PHT-68-208 & PHT-68-209** are designed with 8 position punches for crimping the standard 8P8C plugs, it is not suitable for crimping 10P10C plugs.

- PHT-68-201 & PHT-68-209** with ratchet mechanism.

- all made with layered metal for maximum durability.
- Built in cutter & stripper, with cutter on the back side.
- Length guide included for cutting and stripping.
- Vertical crimping motion for better punch-plug fit.

Fig. 1: 8p8c plug

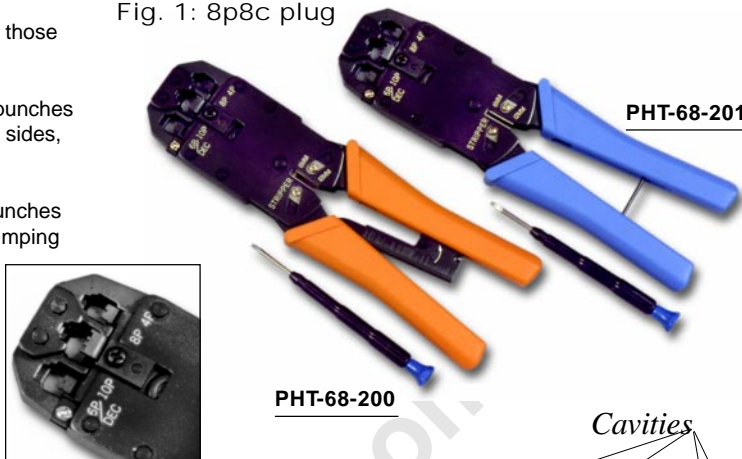

PHT-68-201

PHT-68-200

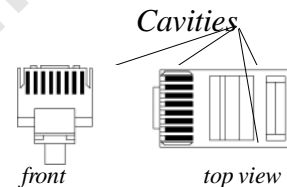

PHT-68 series	10p10c	8p8c standard RJ-45	8p8c cavities RJ-45	6p6c wall outlet	6p6c DEC type	4p4c handset	Ratchet mechanism
200 201	YES	NO	YES	YES	YES	YES	no yes
204 205	NO	YES	YES	YES	NO	NO	no yes
206 207	NO	YES	YES	YES	NO	NO	no yes
208 209	NO	YES	YES	YES	YES	YES	no yes



PHT-68-209



PHT-68-208

7.5" PRO. MODULAR CRIMPING TOOL

- Traditional horizontal crimping motion
- Durable steel construction

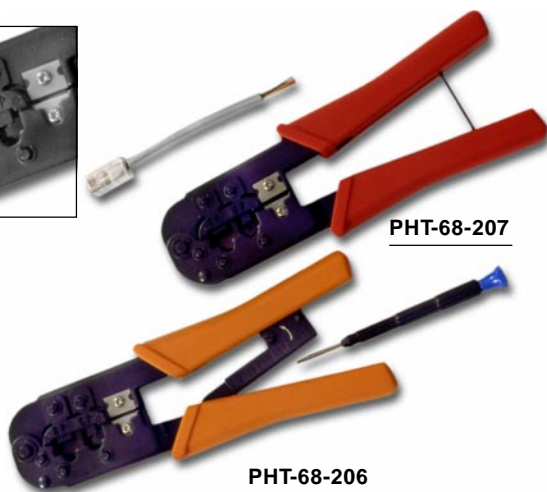
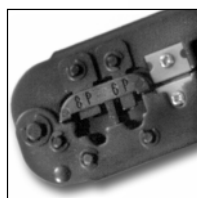

PHT-68-207

PHT-68-206

7.6" PRO. MODULAR CRIMPING TOOL

- Vertical crimping motion for precision fit of the punches
- Zinc alloy die cast sockets for precise fitting of the plugs.

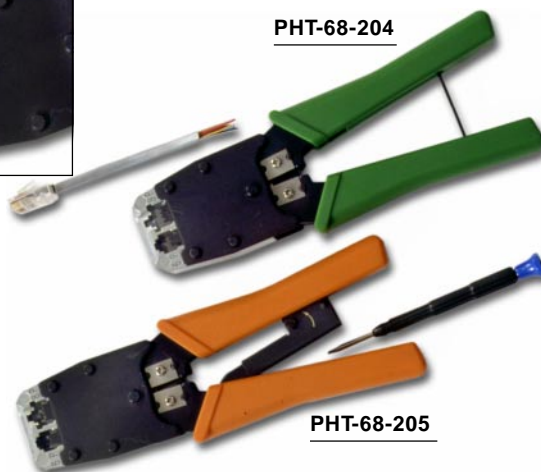

PHT-68-204

PHT-68-205



MODULAR CRIMPING TOOLS

BASIC MODELS (With built-in cutter&stripper)

PHT-120-4C	For Handset Plugs
PHT-120-6C	For RJ11 Plugs
PHT-120-6DEC	For RJ11 DEC Type Plugs
PHT-120-8C	For RJ45 Plugs
PHT-120-10C	For 10p10c Plugs
PHT-110-6/4M	6P6, 6P4 (Economic modular)



PHT-120 Series

PLASTIC MODELS (w/ stripper)

PHT-110-44	For Handset
PHT-110-64	For RJ11-4C
PHT-110-66	For RJ11-6C
PHT-110-864	For Handset, RJ11 and RJ45 plugs



PHT-110-864

SPECIAL MODELS

PHT-68-45-U

For both standard type and AMP type 8p8c RJ-45 plugs. Ratchet mechanism, vertical crimping motion for precision fitting of plugs. Great for Cat5 8p8c plugs with inserts. (Pan # PT-0588 series)

PHT-68-45-S

For shielded RJ45 plugs, including Herose type modular plugs. Ratchet mechanism, vertical crimping motion for precision fitting of plugs.

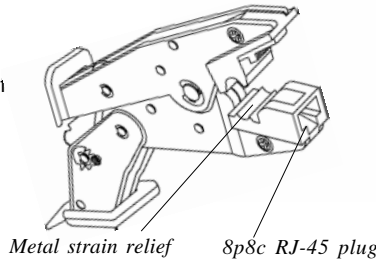
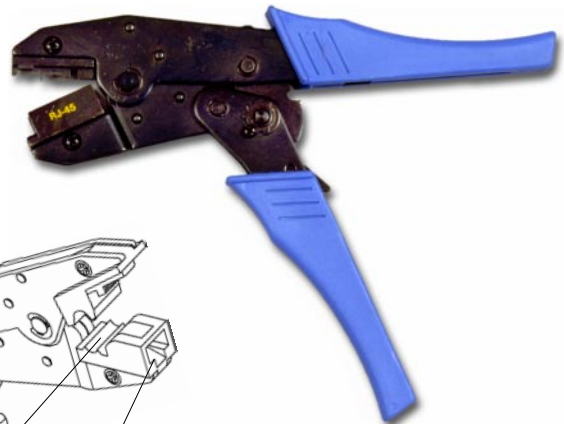

TOOLS FOR V.35

PHT-V35-CMP	Ratchet Crimp tool for 14-22 AWG NON-Insulated Open Barrel, D-Sub Mini Pins & Sockets
PHT-V35-XTR/F	Female Pin Extractor
PHT-V35-XTR/M	Male pin Extractor



PHT-V35-CMP

IDC PLIERS

PHT-37-214	9-1/2" IDC Crimping Fixture Steel Frame for Crimping IDC Connectors. Heights from 6mm to 27.5mm.
PHT-37-215	9-1/2" Fixture Steel Frame W/Attachment for Crimping DIP plugs. Distance 0.1", 0.3", and 0.6" (Within 40 points)



PHT-37-214



Index

Symbols

110-PP-(XX)(JJ)(W) 8

110-PP5-(XX)8T 8

A

AD-15FT4-BK2 18

AD-15FT4-G1 19

AD-15FT6-BK2 18

AD-15FT6-G1 19

AD-15FT6-G1D 19

AD-15FT8-BK1 19

AD-15FT8-BK2 18

AD-15FT8-G1 19

AD-15MT4-BK2 18

AD-15MT4-G1 19

AD-15MT6-BK2 18

AD-15MT6-G1 19

AD-15MT6-G1D 19

AD-15MT8-BK1 19

AD-15MT8-BK2 18

AD-15MT8-G1 19

AD-2506F-G1 19

AD-2506M-G1 19

AD-25FT10-G1 19

AD-25FT10K-G1 19

AD-25FT4-B2 18

AD-25FT4-BK1 19

AD-25FT4-G1 19

AD-25FT4-G2 18

AD-25FT6-B1 19

AD-25FT6-B2 18

AD-25FT6-BK1 19

AD-25FT6-G1 19

AD-25FT6-G1D 19

AD-25FT6-G2 18

AD-25FT6-G2D 18

AD-25FT8-B1 19

AD-25FT8-B2 18

AD-25FT8-BK1 19

AD-25FT8-BKT2 18

AD-25FT8-G1 19

AD-25FT8-G2 18

AD-25FT8-N2 18

AD-25FT8K-G1 19

AD-25MT10-G1 19

AD-25MT10K-G1 19

AD-25MT4-B2 18

AD-25MT4-BK1 19

AD-25MT4-G1 19

AD-25MT4-G2 18

AD-25MT6-B1 19

AD-25MT6-B2 18

AD-25MT6-BK1 19

AD-25MT6-G1 19

AD-25MT6-G1D 19

AD-25MT6-G2 18

AD-25MT6-G2D 18

AD-25MT8-B1 19

AD-25MT8-B2 18

AD-25MT8-BK1 19

AD-25MT8-BKT2 18

AD-25MT8-G1 19

AD-25MT8-G2 18

AD-25MT8-N2 18

AD-25MT8K-G1 19

AD-9FT10-G1 19

AD-9FT10K-G1 19

AD-9FT4-B2 18

AD-9FT4-BK2 18

AD-9FT4-G1 19

AD-9FT4-G2 18

AD-9FT6-B2 18

AD-9FT6-BK1 19

AD-9FT6-BK2 18

AD-9FT6-G1 19

AD-9FT6-G1D 19

AD-9FT6-G2 18

AD-9FT6-G2D 18

AD-9FT8-B2 18

AD-9FT8-BK2 18

AD-9FT8-BKT2 18

AD-9FT8-G1 19

AD-9FT8-G2 18

AD-9MT10-G1 19

AD-9MT10K-G1 19

AD-9MT4-B2 18

AD-9MT4-BK2 18

AD-9MT4-G1 19

AD-9MT4-G2 18

AD-9MT6-B2 18

AD-9MT6-BK2 18

AD-9MT6-G1 19

AD-9MT6-G1D 19

AD-9MT6-G2 18

AD-9MT6-G2D 18

AD-9MT8-B2 18

AD-9MT8-BK2 18

AD-9MT8-BKT2 18

AD-9MT8-G1 19

AD-9MT8-G2 18

ADM-25F6-(CC) 19

ADM-25F8-(CC) 19

ADM-25M6-(CC) 19

ADM-25M8-(CC) 19

ADM-9F6-GR 19

ADM-9F8-(CC) 19

ADM-9M6-GR 19

ADM-9M8-(CC) 19

AT1-G15F4 19

AT1-G15F6 19

AT1-G15M4 19

AT1-G15M6 19

AT1-G25F4 19

AT1-G25F6 19

AT1-G25F6DEC 19

AT1-G25M4 19

AT1-G25M6 19

AT1-G25M6DEC 19

AT1-G9F4 19

AT1-G9F6 19

AT1-G9M4 19

AT1-G9M6 19

AT1-G9M6DEC 19

ATP-3HP 25

ATP-3HS 25

ATP-3MT6 25

ATP-3MT8 25

ATP-5HP 25

ATP-5HS 25

ATP-5MT6 25

ATP-5MT8 25

ATP-FUNNEL 25

ATP-KIT-3P 25

ATP-KIT-3S 25

ATP-KIT-5P 25

ATP-KIT-5S 25

B

BNC-(XXX) 33

BNC-3063 28

BNC-3063-1 28

BNC-3063-2 28

BNC-319(XX) 33

BTS-58-(CC) 17

BTS-59-(CC) 17

D

DC-102-10CD 15

DC-102-4CD 15

DC-102-6CD 15

DC-102-8CD 15

DC-102-8CD-5 15

DC-1021-6-(CC) 13

DC-1021-8-(CC) 13

DC-1021-8-BK-5 13

DC-10A-1 28

DC-10A-2 28

DC-1A-25 26

DC-1A-34 26

DC-1A-43G 26

DC-1A-DEC 26

DC-1A45-2178 26

DC-1A45-45 26

DC-1AM-34 26

DC-1AP-34 26

DC-1AS 26

DC-1ASP-34 26

DC-1ATH45-45 26

DC-1B-34 26

DC-1C-25 26

DC-1C-34 26

DC-1C45-45 26

DC-1CP-34 26

DC-1CSP-34 26

DC-1D-10-RD 27

DC-1D-12-RD 27

DC-1D-20-YW 27

DC-1D-21-YW 27

DC-1D-22-YW 27

DC-1D-31-BL 27

DC-1D-42-WANG 27

DC-1D-51-GRN 27

DC-1D-70-11 26

DC-1D-71-45 26

DC-1D-72-45 26

DC-1D-73-45 26

DC-350GR1000L 16

DC-504S-(LL)SV 5

DC-506S-(LL)SV 5

DC-508S-(LL)SV 5

DC-546P-(LL) GR 5

DC-548P-(LL) GR 5

DC-554(CC)1000 16

DC-554GR1000-L 16

DC-558(CC)1000-L 16

DC-558P-(LL) (CC) M 4

DC-558P-(LL) (CC) MB 5

DC-558P-(LL) BL H 4

DC-558PF-(LL) MB 5

DC-558Q-(LL) (CC) MB 5

DC-5E8P-(LL) (CC) 3

DC-5E8P-(LL) (CC) M 4

DC-5E8P-(LL) (CC) MB 3

DC-5E8P-(LL) BL H 4

DC-5E8P-(LL)BL HMB 4

DC-5E8Q-(LL) (CC) 2, 3

DC-5E8Q-(LL) (CC) MB 3

DC-AP-MAC 28

DC-AP-MACPL 28

DC-APM-MAC 28

DC-B93F2F50 27

DC-CPA-4CF 9

DC-CPA-4CM 9

DC-CPA-6CF 9

DC-CPA-6CM 9

DC-CPA-8CF 9

DC-CPA-8CM 9

DC-CPB-4C 9

DC-CPB-6C 9

DC-CPB-8C 9

DC-DPC 28

DC-HJ-12P4CF-USOC 9

DC-HJ-12P4CM-USOC 9



DC-HJ-12P8CF-10BT 9
 DC-HJ-12P8CM-10BT 9
 DC-HJ-6P8CF-ATT 9
 DC-HJ-6P8CF-USOC 9
 DC-HJ-6P8CM-ATT 9
 DC-HJ-6P8CM-USOC 9
 DC-HJ-8P6CF-USOC 9
 DC-HJ-8P6CM-USOC 9
 DC-IIAP 26
 DC-M-1M 26
 DC-M-1M-T&B 26
 DC-M-1M-TW 26
 DC-M-1M4 26
 DC-M-BNC-8' 27
 DC-M-BNC2-8' 27
 DC-M-D9-8' 27
 DC-M-DPC-8' 27
 DC-M-TWX-8' 27
 DC-M2-8' 27
 DC-MD-4C 26
 DC-MD-6C 26
 DC-MD-8C-1 26
 DC-MD-8C-2 26
 DC-MD-8C-3 26
 DC-MF-9MT6 27
 DC-MF-9MT8 27
 DC-OCT-12P4CF-USOC 9
 DC-OCT-12P4CM-USOC 9
 DC-OCT-6P8CF-ATT 9
 DC-OCT-6P8CF-USOC 9
 DC-OCT-6P8CM-ATT 9
 DC-OCT-6P8CM-USOC 9
 DC-OCT-8P6CF-USOC 9
 DC-OCT-8P6CM-USOC 9
 DC-PP-24P-4C-USOC 10
 DC-PP-24P-6C-USOC 10
 DC-PP-24P-8C-ATT 10
 DC-PP-24P-8C-USOC 10
 DC-PP-32P-4C-USOC 10
 DC-PP-32P-6C-USOC 10
 DC-PP-32P-8C-ATT 10
 DC-PP-32P-8C-USOC 10
 DC-PP-48P-4C-USOC 10
 DC-PP-48P-6C-USOC 10
 DC-PP-48P-8C-ATT 10
 DC-PP-48P-8C-USOC 10
 DC-PP-64P-4C-USOC 10
 DC-PP-64P-6C-USOC 10
 DC-PP-64P-8C-ATT 10
 DC-PP-64P-8C-USOC 10
 DC-PP-96P-4C-USOC 10
 DC-PP-96P-6C-USOC 10
 DC-PP-96P-8C-ATT 10
 DC-PP-96P-8C-USOC 10
 DC-PPWG 10
 DC-TA707A/CO 25
 DC-TA707A/M 25
 DC-TA709A/15 25

DC-TA709A/9 25
 DC-TELCO-BRK 9
 DC-VC-6C 13
 DC-VC-8CK 13
 DC-VC2-6C-(CC) 13
 DC-VC2-6C-CAP 13
 DC-VC2-6D-(CC) 13
 DC-VC2-8C-(CC) 13
 DC-VC2-8C-CAP 13
 DC-VC2-8NK-(CC) 13
 DC-VC3-6-(CC) 13
 DC-VC3-8-(CC) 13
 DC-VC3-CAP48-568 13
 DC-VC3-CAP48-USOC 13
 DC-VC4-6 (CC) 13
 DC-VC4-8A (CC) 12, 13
 DC-VC5-8-(CC) 13
 DC-VC5-8-(CC)-R 12
 DC-VC5-8AS 13
 DC-W10-1000 17
 DC-W10-500 17
 DC-W4-1000BK 17
 DC-W4-1000UL 17
 DC-W4-50 17
 DC-W4-500 17
 DC-W4-500BK 17
 DC-W4-500UL 17
 DC-W6-100 17
 DC-W6-1000BK 17
 DC-W6-1000UL 17
 DC-W6-50 17
 DC-W6-500 17
 DC-W6-500BK 17
 DC-W6-500UL 17
 DC-W8-100 17
 DC-W8-1000BK 17
 DC-W8-1000UL 17
 DC-W8-50 17
 DC-W8-500 17
 DC-W8-500BK 17
 DC-W8-500UL 17
 DC-WST4-1000024GR 17
 DC-WT10-500 17
 DC-WT101000 17
 DC-WT2-1000 17
 DC-WT4-1000 17
 DC-WT4-1000-BK-24 17
 DC-WT4-500 17
 DC-WT4-500-BK-24 17
 DC-WT6-1000 17
 DC-WT6-1000-BK-24 17
 DC-WT6-1000-SV-24 17
 DC-WT6-1000-SV-24UL 17
 DC-WT6-500 17
 DC-WT6-500-BK-24 17
 DC-WT6-500-SV-24 17
 DC-WT6-500-SV-24UL 17
 DC-WT8-1000 17

DC-WT8-500 17
 DCS-102-8CD-5 15
 DCS-558GR1000 17
 DCS-558GR1000L 17
 DCS-5E8-(LL) GR MB 4

F

FOA-FC 6
 FOA-ST 6
 FOC-SC-SM 6
 FOC-ST-MM 6
 FOC-ST-SM 6
 FOP-(EE)-(D)-(MD)-LL 6
 FOP-SC2D-MM-(LL) 6
 FOP-SC2D-SM-(LL) 6
 FOP-ST2D-SM-(LL) 6
 FOP-STSCD-MM-(LL) 6
 FOP-STSCD-SM-(LL) 6

H

Hub-10BT-5 15

M

MF-BLK-(CC) 14
 MF-BNC-(CC) 14
 MF-BNC1-(CC) 14
 MF-FOC-(CC) 14
 MF-FOC1-(CC) 14
 MF-KSJ-(CC) 14
 MF-KSJ1-(CC) 14
 MF-RFF-(CC) 14
 MF-RFF1-(CC) 14

P

PHT-110-44 36
 PHT-110-44-6/4M 36
 PHT-110-64 36
 PHT-110-66 36
 PHT-110-864 36
 PHT-120-10C 36
 PHT-120-4C 36
 PHT-120-6C 36
 PHT-120-6DEC 36
 PHT-120-8C 36
 PHT-68-200 35
 PHT-68-201 35
 PHT-68-204 35
 PHT-68-205 35
 PHT-68-206 35
 PHT-68-207 35
 PHT-68-208 35
 PHT-68-209 35
 PHT-68-45-S 36
 PHT-68-45-U 36
 PHT-76 14 Series 34
 PHT-76 24 Series 34

PHT-76 34 Series 34
 PHT-76-011 34
 PHT-76-061 34
 PHT-76-066 34
 PHT-76-0K 34
 PHT-76-140 34
 PHT-76-240 34
 PHT-76-340 34
 PHT-V35-CMP 28, 36
 PHT-V35-XTR/F 28, 36
 PHT-V35-XTR/M 28, 36
 PPS-A25B-DE(LL) 7
 PPS-A25B-DE(LL)-L5 7
 PPS-A25B-SE(LL) 7
 PPS-A25B-SE(LL)-L5 7
 PPS-B25A-(LL) 7
 PPS-B25A-(LL)-L5 7
 PPS-B25B-DE(LL) 7
 PPS-B25B-DE(LL)-L5 7
 PPS-B25B-SE(LL) 7
 PPS-B25B-SE(LL)-L5 7
 PT-0364R 20
 PT-0364R/50UL 20
 PT-0366R 20
 PT-0366R/50UL 20
 PT-0388-50UL 20
 PT-0388KR 20
 PT-0388KR/50UL 20
 PT-0388R 20
 PT-0388R/50UL 20
 PT-03A88R 20
 PT-044 20
 PT-044/50UL 20
 PT-044R 20
 PT-044R/50UL 20
 PT-0588-50UL 21
 PT-064 20
 PT-064/50UL 20
 PT-064R 20
 PT-064R/50UL 20
 PT-064RS 20
 PT-064RS/50UL 20
 PT-066 20
 PT-066/50UL 20
 PT-066DEC 20
 PT-066DEC/50UL 20
 PT-066DRS 20
 PT-066DRS/50UL 20
 PT-066R 20
 PT-066R/50UL 20
 PT-066RS/50UL 20
 PT-088 20
 PT-088/50UL 20
 PT-088K 20
 PT-088K/50UL 20
 PT-088KR 20
 PT-088KR/50UL 20
 PT-088KRS 20



PT-088KRS/50UL 20
PT-088R 20
PT-088R/50UL 20
PT-088RS 20
PT-088RS/50UL 20
PT-0A88RS 20
PT-101-444 22
PT-101-448 22
PT-101-666 22
PT-101-888 22
PT-1010 20
PT-1010K 20
PT-1010RS 20
PT-101J-444 22
PT-101J-666 22
PT-101J-888 22
PT-102-4C 15
PT-102-6C 15
PT-102-8C 15
PT-103-4U 23
PT-103-4U/UL 23
PT-103-68A-UL 23
PT-103-6D/UL 23
PT-103-6NW 23
PT-103-6U 23
PT-103-6U/UL 23
PT-103-8A 23
PT-103-8A/UL 23
PT-103-8AK 23
PT-103-8AK/UL 23
PT-103-8U 23
PT-103-8U/UL 23
PT-103B-4C 23
PT-103D-4C 23
PT-104-44U 23
PT-104-44U-UL 23
PT-104-66NW 23
PT-104-66U 23
PT-104-66U-UL 23
PT-104-6DD 23
PT-104-88A 23
PT-104-88A-UL 23
PT-104-8AKK 23
PT-104-8AKK-UL 23
PT-104B-44 23
PT-104D-44 23
PT-105-4C 23
PT-105-6C 23
PT-106-4C 23
PT-106-6C 23
PT-106D-4C 23
PT-106D-6C 23
PT-107-4C 23
PT-108-4C 22
PT-108A-4C 22
PT-108A-4C-UL 22
PT-108A-6C 22
PT-108A-6C-UL 22

PT-108A-8C 22
PT-108A-8C-SB 22
PT-108A-8C-UL 22
PT-108B-4C 22
PT-109-4C 22
PT-1103-4/UL 24
PT-1103-4C 24
PT-1103-6/UL 24
PT-1103-6C 24
PT-1103-6DEC 24
PT-1103-6DEC/UL 24
PT-1103-8/UL 24
PT-1103-8C 24
PT-1103-8CK 24
PT-1103-8K/UL 24
PT-1104A-44 22
PT-1104A-44-WH 22
PT-1104A-66 22
PT-1104A-88 22
PT-1104A-88-WH 22
PT-1104B-44 24
PT-1104B-44/UL 24
PT-1104B-66 24
PT-1104B-66/UL 24
PT-1104B-68K/UL 24
PT-1104B-6DD/UL 24
PT-1104B-88 24
PT-1104B-88/UL 24
PT-1104B-88K 24
PT-1104B-88K/UL 24
PT-1104B-8KK 24
PT-111-1 13
PT-111-2 13
PT-1112 14
PT-111F1 14
PT-111J1-IV 14
PT-111J2 14
PT-1124 14
PT-113-(XX)-UL 24
PT-113C-UL 24
PT-114C-UL 24
PT-115-UL 24
PT-1154-8 14
PT-115B-UL 24
PT-204-15' 23
PT-204-25' 23
PT-304-15' 23
PT-304-25' 23
PT-404-15' 23
PT-404-25' 23
PT-404-7' 23
PT-408-7'SV 23
PT-504X-(LL) 22
PT-506X-(LL) 22
PT-508X-(LL) 22
PT-604-07' 23
PT-604-12' 23
PT-604-18' 23

PT-604-25' 23
PT-LK-TEST-6/8 15
PT-LK-TEST-DEC 15
PT-O3A88R/50UL 20
PTC-RJ45-50 (CC) 21
PTC-RJ45-55 (CC) 21
PTC-RJ45-60 (CC) 21
PTC-RJ45-65 (CC) 21
PTC-RJ45-F (CC) 21
PTC-SNP11-(CC) 21
PTC-SNP45-(CC) 21
PTS-0388R-50UL 21
PTS-03A88R 21
PTS-03A88R-50UL 21
PTS-03AW88 21
PTS-03AW88R 21
PTS-03AW88R-50UL 21
PTS-0510-50UL 21
PTS-0588-50UL 21
PTS-088-S1 21
PTS-088R-50UL 21

R

RG-58AU-500 17
RG-58U-500 17

S

S-BNC58A 17

T

TSR-NETCBL 15
TSR-RMTNET 15
TWX-350(XX) 33
TWX-3502 33

V

V35-HP 28
V35-HS 28
V35-P/F 28
V35-P/M 28
V35-S-HP 28
V35-S-HS 28
V35-SCRSET 28
V35-SH 28

W

WP-15-(XX)H 30
WP-15-1HD 30
WP-25-(XX)H 30
WP-25-2HD 30
WP-25-4HD 30
WP-25/TW 30
WP-25C 30
WP-25M 30
WP-25MD 30
WP-25T/11 30

WP-36-1H 30
WP-9-(XX)H 30
WP-C-(HH) 33
WP-C-(HH) 3/8" 33
WP-C-(XX)H3/8 30
WP-C-1H 33
WP-C-2H 33
WP-C-2HD 30, 33
WP-C/M 30
WP-IBM-1 30
WP-IBM-1P 25
WP-IBM-2P 25
WP-IBM-3M 25
WP-IBM-3P 25
WP-IBM-4M 25
WP-IBM/C 30
WP-IBM/M 30
WP-M-(XX)H 30
WP-M-4D 30
WP-TW-(HH) 33
WP-TW-(XX)H 30
WP-TW-1H 33
WP-TW-2H 33
WPD 30
WPK-09HS/T-(X) 33
WPK-09P-2 33
WPK-25HS-2 33
WPK-25HS/T-1 33
WPK-25S-1 33
WPK-B(XXX)-(HH) 33
WPK-B319(XX)-(HH) 33
WPK-B3191-1 33
WPK-B3191-2 33
WPK-B3191-2D 33
WPK-B3192-1 33
WPK-B3192-2 33
WPK-B3192-2D 33
WPK-B3193-1 33
WPK-B3193-2 33
WPK-B3193-2D 33
WPK-M6C-25P/T 33
WPK-TW350(XX)-(HH) 33
WPK-TW3502-1 33
WPK-TW3502-2 33
WPP-(X) 11
WPP-(X)A 11, 13
WPP-B1 13
WPP-B2 13
WPP-BNC1 13
WPP-RCA1 13
WPP-RFF1 13
WPS 30
WRP-09-16 31
WRP-09-32/3U 31
WRP-15-16 31
WRP-19/1.75 10, 32
WRP-19/3.5 10, 32
WRP-25-16 31



WRP-25-32/4U **31**
WRP-37-16 **31**
WRP-50-16 **31**
WRP-66M-12 **10**
WRP-BRK-1.75 **10**
WRP-BRK-3.50 **10**
WRP-BRK-5.25 **10**
WRP-BRK-7.0 **10**
WRP-BRK-8.75 **10**
WRP-C-16 **31**
WRP-C-16 3/8" **31**
WRP-C-16/1U **31**
WRP-C-24 **31**
WRP-C-24 3/8" **31**
WRP-C-2X8 **31**
WRP-C-2X8 3/8" **31**
WRP-C-32 **31**
WRP-C-32 3/8" **31**
WRP-IBM-12 **10, 31**
WRP-IBM-12/1U **10, 31**
WRP-IBM-16/3U **10, 31**
WRP-IBM/M-12 **10, 32**
WRP-M-12 **10, 32**
WRP-M-12/1U **10, 32**
WRP-M-16 **10, 32**
WRP-M-16/1U **10, 32**
WRP-M-24 **10, 32**
WRP-M-32 **10, 32**
WRP-M-36/3U **10, 32**
WRP-M-3X8 **32**
WRP-M-48 **32**
WRP-M-48/3U **10, 32**
WRP-M-48V/4U **10, 32**
WRP-M-64/4U **10, 32**
WRP-MA-12/1U **14**
WRP-MA-16/1U **14, 32**
WRP-MA-24 **14, 32**
WRP-MA-32 **14, 32**
WRP-RACK **29**
WRP-RACK-TT **29**
WRP-SCR **10**
WRP-TW-16 **32**
WRP-TW-24 **32**
WRP-TW-32 **32**

onlinecomponents.com