

Thermal device circuit breaker - XBATCP6 - 3218679

Please be informed that the data shown in this PDF Document is generated from our Online Catalog. Please find the complete data in the user's documentation. Our General Terms of Use for Downloads are valid (<http://download.phoenixcontact.com>)



Thermal miniature circuit breaker, pluggable in screw-type fuse terminal block UK 6-FSI/C and spring-cage fuse terminal block ST 4-FSI/C

The illustration shows version TCP
2A



Key commercial data

Packing unit	1 PCE
Minimum order quantity	500 PCE
GTIN	 4 046356 091008
Custom tariff number	85363030
Country of origin	INDONESIA

Technical data

Product type	Thermal device circuit breakers
Fuse type	Slow-blow
Mounting type	Base assembly (pluggable)
Nominal current I_N	6 A
Nominal voltage U_N	250 V

Classifications

ETIM

ETIM 2.0	EC000899
ETIM 3.0	EC000899
ETIM 4.0	EC000899

Thermal device circuit breaker - XBATCP6 - 3218679

Classifications

UNSPSC

UNSPSC 11	39121411
UNSPSC 12.01	39121411
UNSPSC 13.2	39121411
UNSPSC 6.01	30211812
UNSPSC 7.0901	39121411

eCl@ss

eCl@ss 4.0	27141116
eCl@ss 4.1	27141116
eCl@ss 5.0	27141116
eCl@ss 5.1	27141116
eCl@ss 6.0	27141116
eCl@ss 7.0	27141116

Accessories

Accessories

Marking

Flat zack marker sheet - ZBFM 5/WH:UNBEDRUCKT - 0803595



Flat zack marker sheet, Sheet, white, Unlabeled, Can be labeled with: Plotter, Mounting type: Snap into flat marker groove, For terminal block width: 5.2 mm, Lettering field: 5 x 4.5 mm

Flat zack marker sheet - ZBFM 5/OG:UNBEDRUCKT - 0807180



Flat zack marker sheet, Sheet, orange, Unlabeled, Can be labeled with: Plotter, Mounting type: Snap into flat marker groove, For terminal block width: 5.2 mm, Lettering field: 5 x 4.5 mm

Additional products

Thermal device circuit breaker - XBATCP6 - 3218679

Accessories

Fuse modular terminal block - UK 6-FSI/C - 3118203



Flat-type fuse terminal block, cross section: 0.2 - 6 mm², AWG: 26 - 8, width: 8.2 mm, color: black

Fuse modular terminal block - ST 4-FSI/C - 3036372



Fuse modular terminal block, Connection method: Spring-cage connection, Cross section: 0.08 mm²- 6 mm², AWG: 28 - 10, Nominal current: 30 A, Nominal voltage: 400 V, Width: 8.2 mm, Fuse type: C, Fuse type: Flat, Mounting type: NS 35/7,5, NS 35/15, Color: black

Drawings

Thermal device circuit breaker - XBATCP6 - 3218679

Diagram

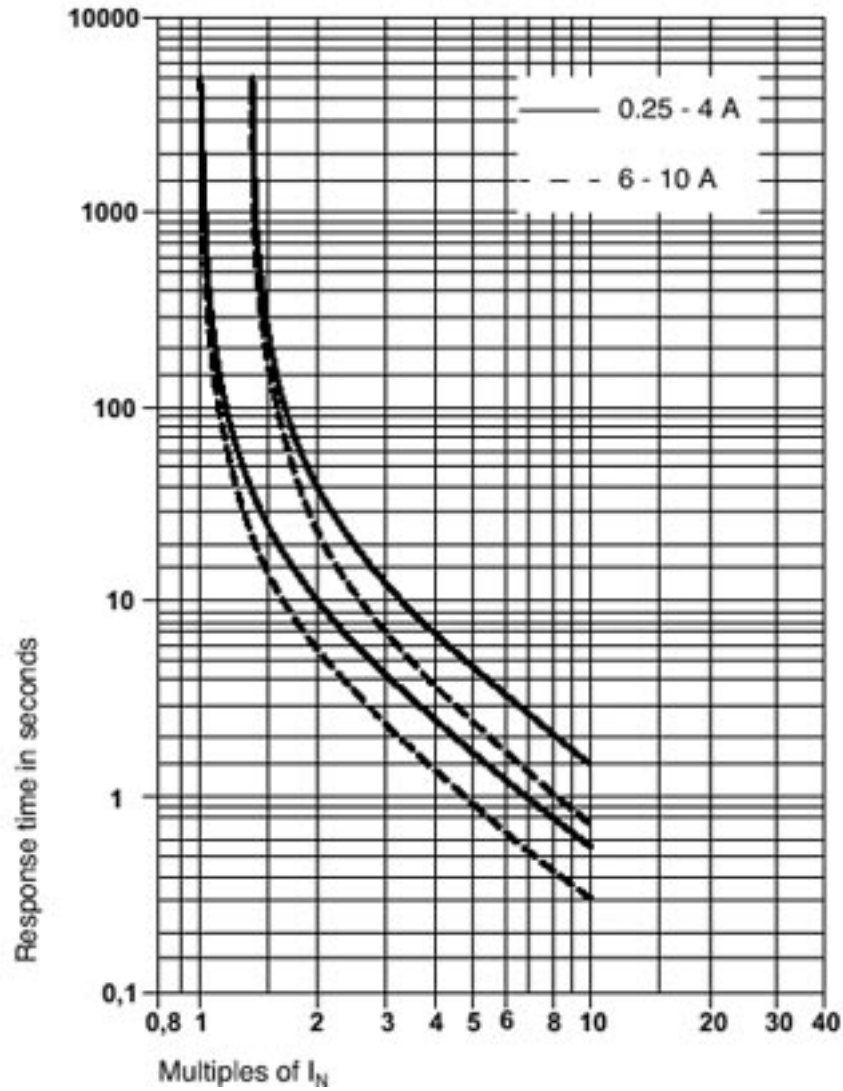

Thermal device circuit breaker - XBATCP6 - 3218679

Application drawing

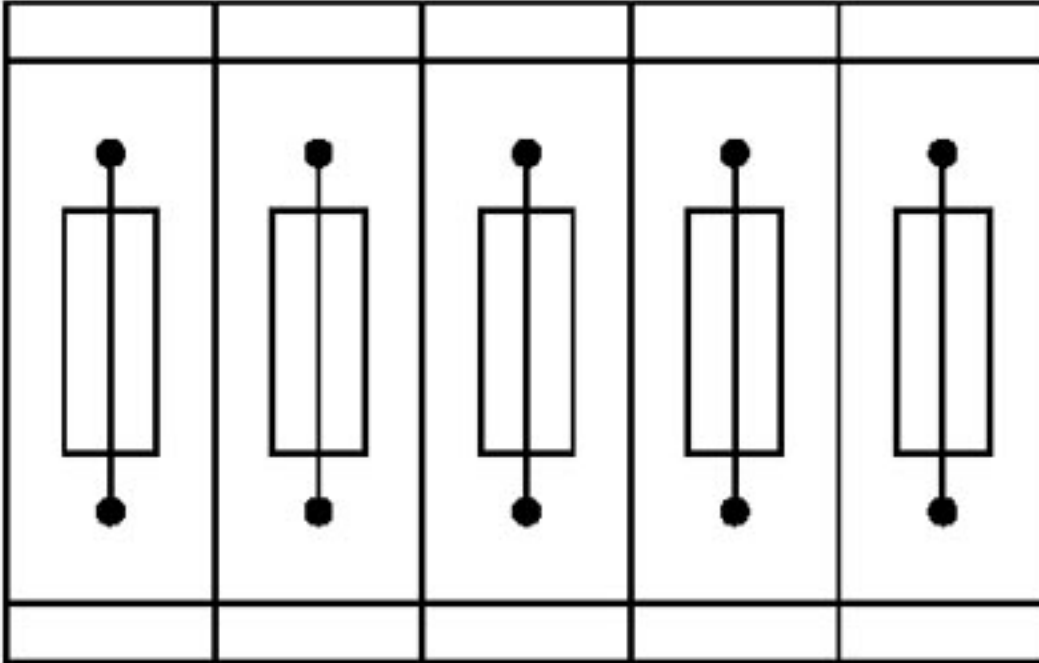

Fuse terminal blocks in interconnected arrangement,
block consisting of 5 fuse terminal blocks

Thermal device circuit breaker - XBATCP6 - 3218679

Application drawing

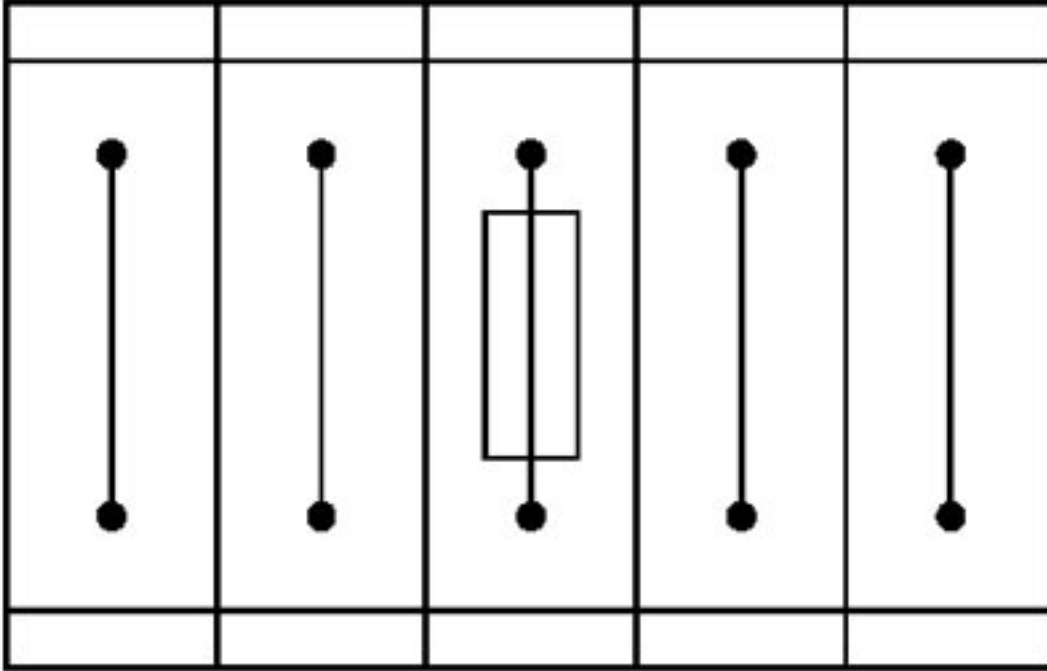

Fuse terminal block in single arrangement,
block consisting of one fuse terminal block and 4 feed-through terminal blocks

Thermal device circuit breaker - XBATCP6 - 3218679

Dimensioned drawing

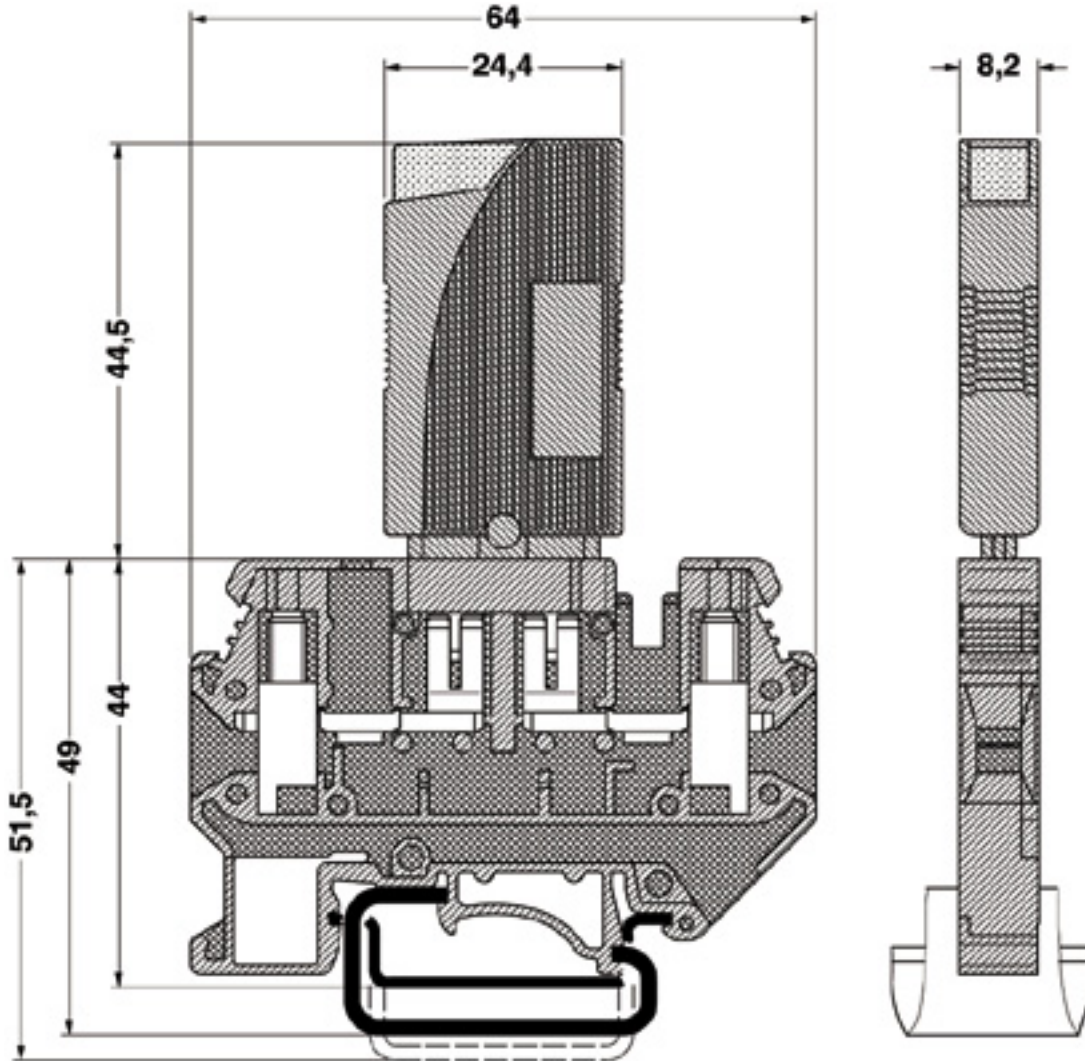

Thermal device circuit breaker - XBATCP6 - 3218679

Dimensioned drawing

