

Thermomagnetic device circuit breaker - TMC 81D 05A - 2907630

Please be informed that the data shown in this PDF Document is generated from our Online Catalog. Please find the complete data in the user's documentation. Our General Terms of Use for Downloads are valid (<http://phoenixcontact.com/download>)



Thermomagnetic device circuit breaker, number of positions: 1, width: 17.6 mm, mounting type: DIN rail: 35 mm, Color: gray

RoHS

Key Commercial Data

Packing unit	1 STK
Weight per Piece (excluding packing)	150.000 g
Country of origin	China

Technical data

General

Mounting type	DIN rail: 35 mm
Color	gray
Number of positions	1

Electrical data

Operating voltage	277 V AC
	60 V DC
Rated current I_N	5 A
Rated short-circuit switching capacity I_{cn}	10 kA (IC)

Dimensions

Height	116 mm
Width	17.6 mm
Depth	65.7 mm

Ambient conditions

Ambient temperature (operation)	-35 °C ... 70 °C
---------------------------------	------------------

Thermomagnetic device circuit breaker - TMC 81D 05A - 2907630

Technical data

Standards and Regulations

Standards/specifications	UL 489 IEC 60947-2
--------------------------	--------------------

Drawings

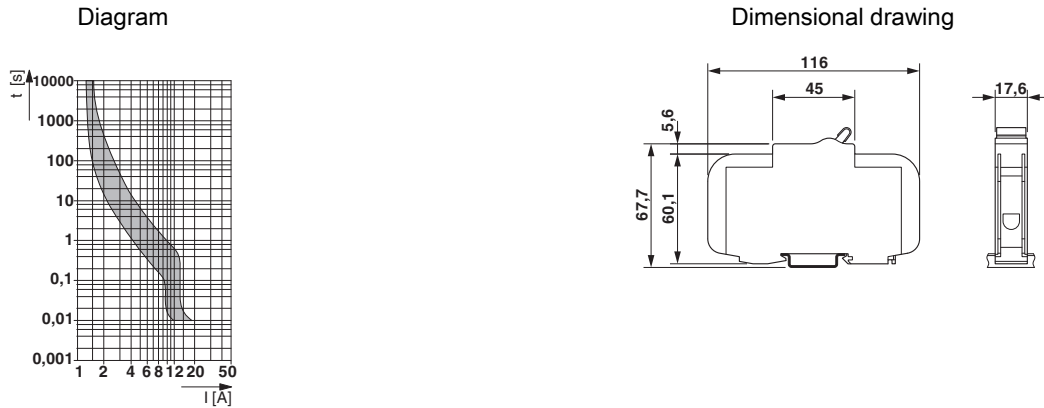

Classifications

eCl@ss

eCl@ss 4.0	27141116
eCl@ss 4.1	27141116
eCl@ss 5.0	27141116
eCl@ss 5.1	27141116
eCl@ss 6.0	27141116
eCl@ss 7.0	27141116
eCl@ss 8.0	27141116
eCl@ss 9.0	27141116

ETIM

ETIM 3.0	EC000899
ETIM 4.0	EC000899
ETIM 5.0	EC000899
ETIM 6.0	EC000899

UNSPSC

UNSPSC 6.01	30211812
UNSPSC 7.0901	39121411
UNSPSC 11	39121411
UNSPSC 12.01	39121411

Thermomagnetic device circuit breaker - TMC 81D 05A - 2907630

Classifications

UNSPSC

UNSPSC 13.2	39121620
-------------	----------

Approvals

Approvals

Approvals

UL Listed / cUL Listed / cULus Listed

Ex Approvals

Approval details

UL Listed		http://database.ul.com/cgi-bin/XYV/template/LISEXT/1FRAME/index.htm	FILE E 320373
-----------	--	---	---------------

cUL Listed		http://database.ul.com/cgi-bin/XYV/template/LISEXT/1FRAME/index.htm	FILE E 320373
------------	---	---	---------------

cULus Listed			
--------------	---	--	--