

Plug - MCVU 1,5/16-GFD-3,81 - 1833166

Please be informed that the data shown in this PDF Document is generated from our Online Catalog. Please find the complete data in the user's documentation. Our General Terms of Use for Downloads are valid (<http://phoenixcontact.com/download>)



Direct plug-in block, nominal current: 8 A, rated voltage (III/2): 160 V, Nominal cross section: 1.5 mm², number of positions: 16, pitch: 3.81 mm, connection method: Screw connection with tension sleeve, color: green, contact surface: Tin, mounting: Direct mounting

The figure shows a 10-position version of the product

Your advantages

- ✓ Screwable flange for superior mechanical stability
- ✓ Laterally mounted flange for screw connection in the housing or on the mounting plate
- ✓ Maximum flexibility when it comes to device design – one header for connectors with different connection technologies

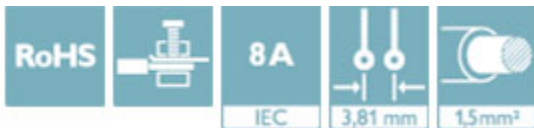

Key Commercial Data

Packing unit	1 pc
Minimum order quantity	50 pc
GTIN	 4 017918 051853
GTIN	4017918051853
Weight per Piece (excluding packing)	16.800 g
Custom tariff number	85366990
Country of origin	Poland

Technical data

Dimensions

Length [l]	20.3 mm
Width [w]	71.35 mm
Height [h]	12.5 mm
Pitch	3.81 mm

Plug - MCVU 1,5/16-GFD-3,81 - 1833166

Technical data

Dimensions

Dimension a	57.15 mm
-------------	----------

General

Range of articles	MCVU 1,5/...-GFD
Number of positions	16
Connection method	Screw connection with tension sleeve
Insulating material group	I
Rated surge voltage (III/3)	2.5 kV
Rated surge voltage (III/2)	2.5 kV
Rated surge voltage (II/2)	2.5 kV
Rated voltage (III/3)	160 V
Rated voltage (III/2)	160 V
Rated voltage (II/2)	320 V
Connection in acc. with standard	EN-VDE
Nominal current I_N	8 A
Nominal cross section	1.5 mm ²
Maximum load current	8 A
Insulating material	PA
Flammability rating according to UL 94	V0
Internal cylindrical gage	A1
Stripping length	7 mm
Screw thread	M2
Tightening torque, min	0.22 Nm
Tightening torque max	0.25 Nm

Connection data

Conductor cross section solid min.	0.14 mm ²
Conductor cross section solid max.	1.5 mm ²
Conductor cross section flexible min.	0.14 mm ²
Conductor cross section flexible max.	1.5 mm ²
Conductor cross section flexible, with ferrule without plastic sleeve min.	0.25 mm ²
Conductor cross section flexible, with ferrule without plastic sleeve max.	1.5 mm ²
Conductor cross section flexible, with ferrule with plastic sleeve min.	0.25 mm ²
Conductor cross section flexible, with ferrule with plastic sleeve max.	0.5 mm ²
Conductor cross section AWG min.	28
Conductor cross section AWG max.	16
2 conductors with same cross section, solid min.	0.14 mm ²
2 conductors with same cross section, solid max.	0.5 mm ²

Plug - MCVU 1,5/16-GFD-3,81 - 1833166

Technical data

Connection data

2 conductors with same cross section, stranded min.	0.14 mm ²
2 conductors with same cross section, stranded max.	0.75 mm ²
2 conductors with same cross section, stranded, ferrules without plastic sleeve, min.	0.25 mm ²
2 conductors with same cross section, stranded, ferrules without plastic sleeve, max.	0.34 mm ²
2 conductors with same cross section, stranded, TWIN ferrules with plastic sleeve, min.	0.5 mm ²
2 conductors with same cross section, stranded, TWIN ferrules with plastic sleeve, max.	0.5 mm ²
Minimum AWG according to UL/CUL	30
Maximum AWG according to UL/CUL	14

Standards and Regulations

Connection in acc. with standard	EN-VDE
	CSA
Flammability rating according to UL 94	V0

Environmental Product Compliance

	Lead 7439-92-1
China RoHS	Environmentally Friendly Use Period = 50
	For details about hazardous substances go to tab "Downloads", Category "Manufacturer's declaration"

Drawings

Plug - MCVU 1,5/16-GFD-3,81 - 1833166

Drilling diagram

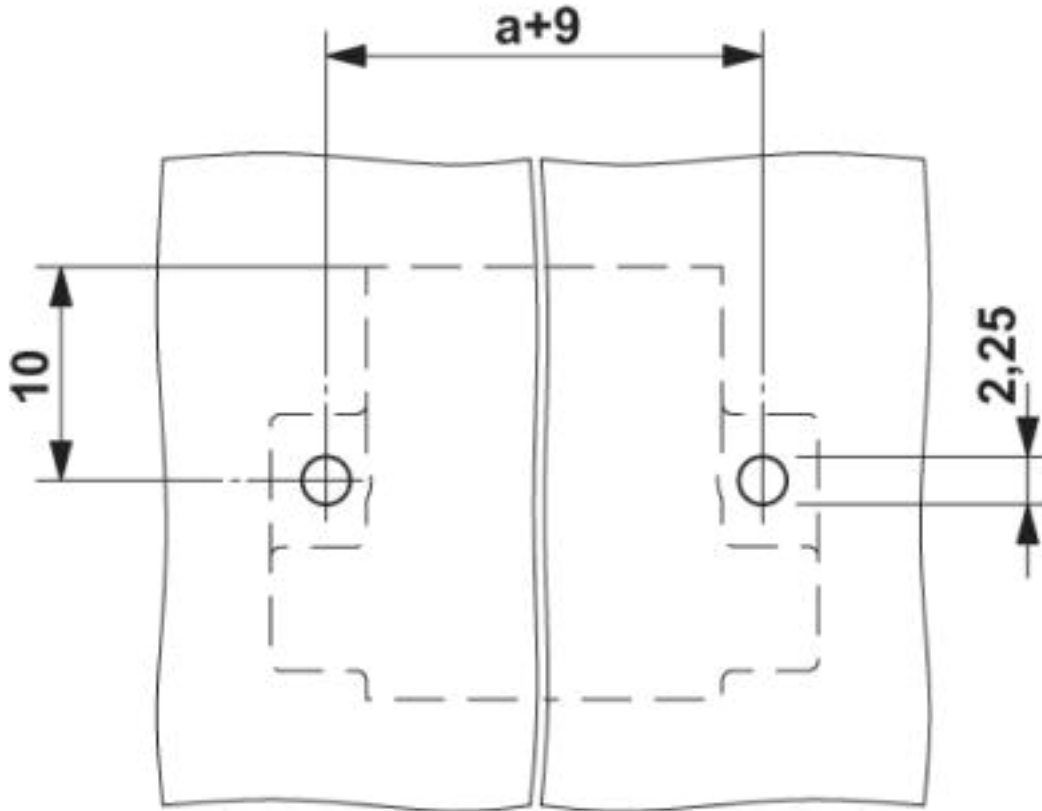

Plug - MCVU 1,5/16-GFD-3,81 - 1833166

Diagram

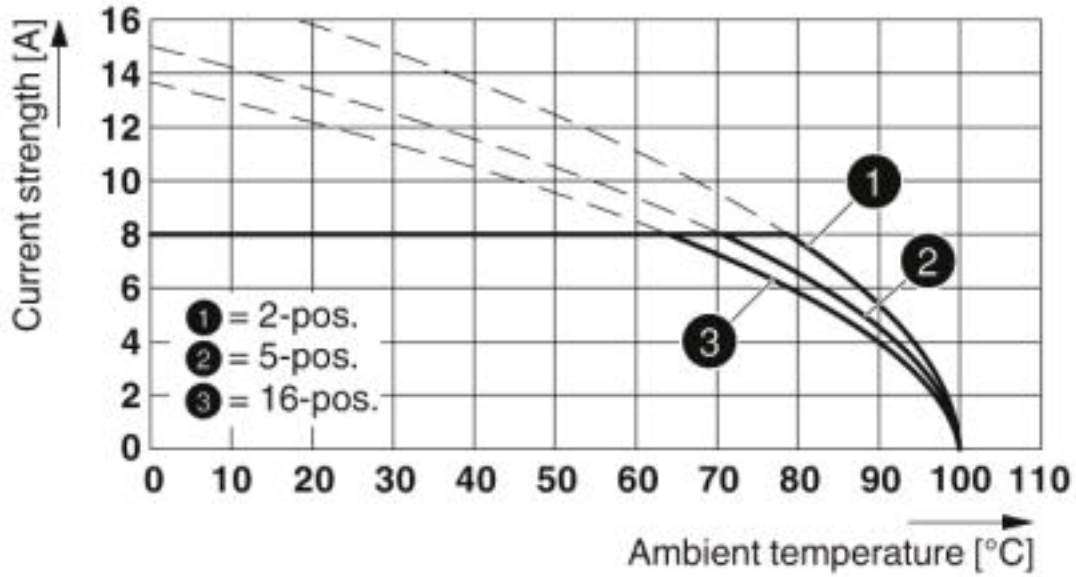

Type: FK-MCP 1,5/...-ST-3,81 with MCVU 1,5/...-GFD-3,81

Diagram

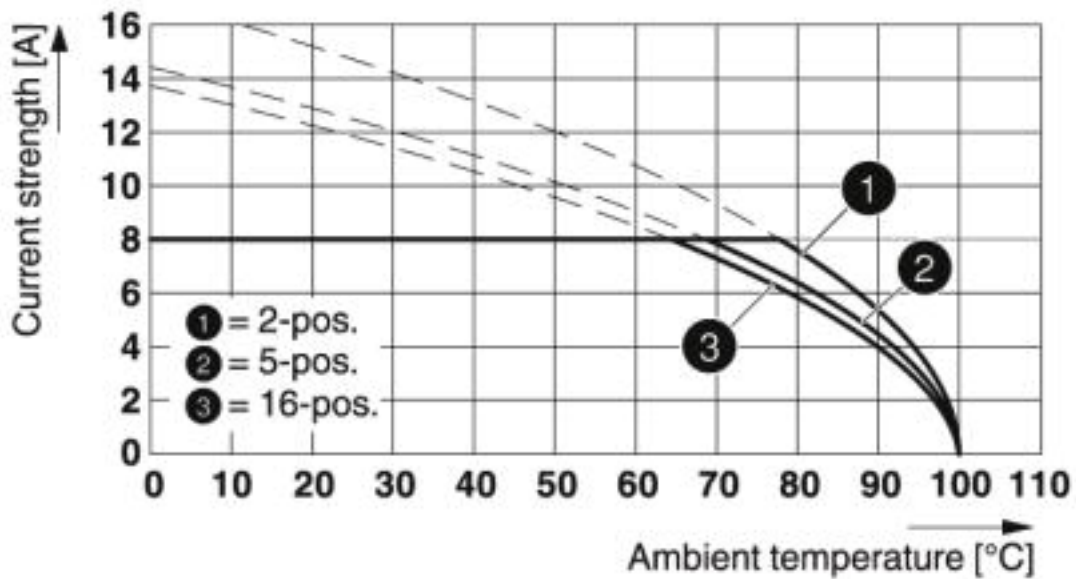

Type: FMC 1,5/...-ST-3,81 with MCVU 1,5/...-GFD-3,81

Plug - MCVU 1,5/16-GFD-3,81 - 1833166

Diagram

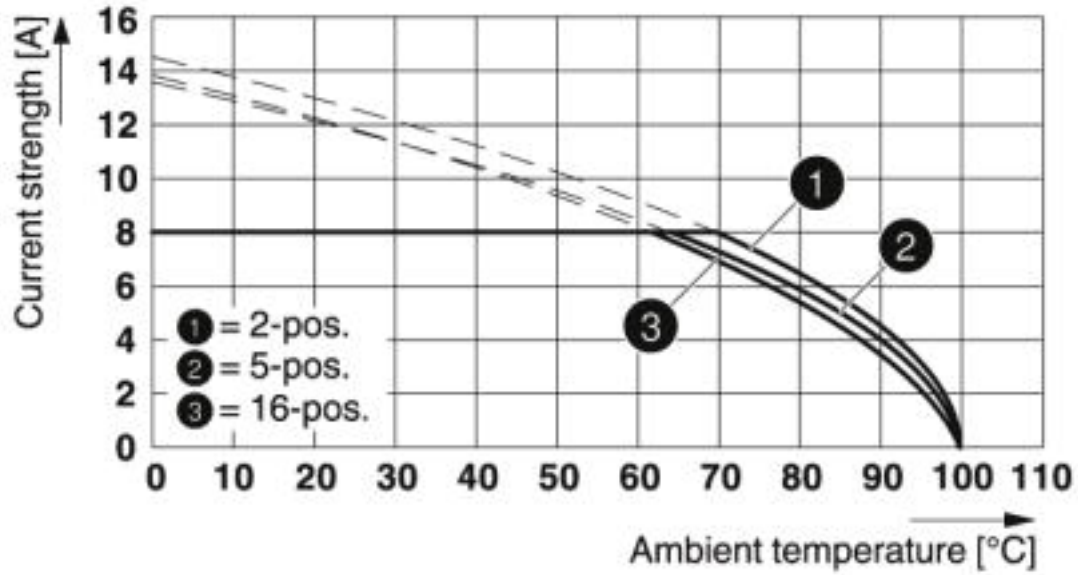

Type: MC 1,5/...-ST-3,81 with MCVU 1,5/...-GFD-3,81

Diagram

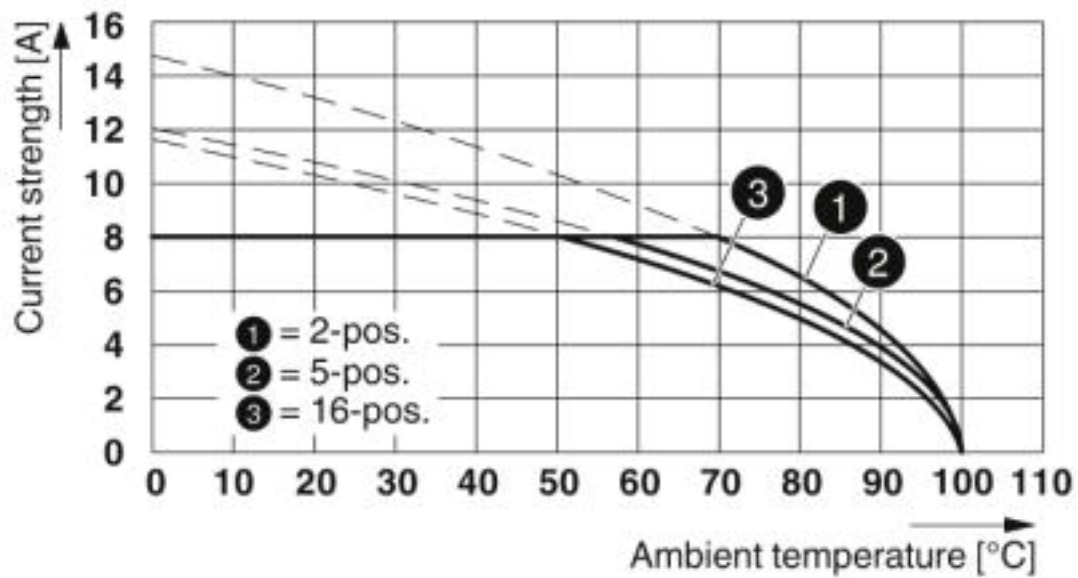

Type: MCVR 1,5/...-STF-3,81 with MCVU 1,5/...-GFD-3,81

Plug - MCVU 1,5/16-GFD-3,81 - 1833166

Dimensional drawing

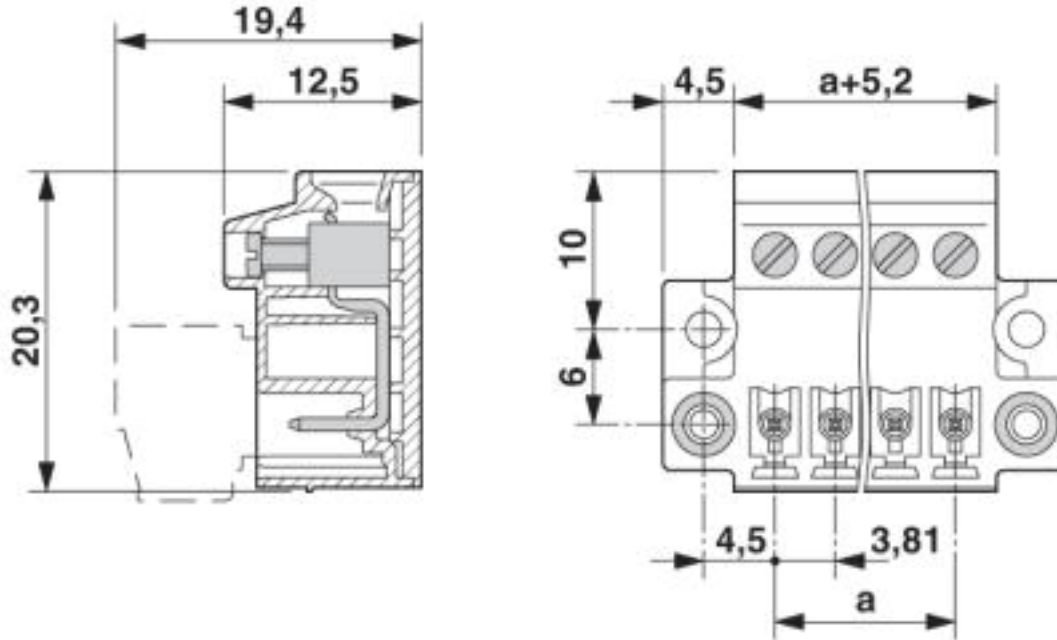

Classifications

eCl@ss

eCl@ss 4.0	27260700
eCl@ss 4.1	27260700
eCl@ss 5.0	27141100
eCl@ss 5.1	27141100
eCl@ss 6.0	27141100
eCl@ss 7.0	27141106
eCl@ss 8.0	27440309
eCl@ss 9.0	27440309

ETIM

ETIM 3.0	EC001121
ETIM 4.0	EC002638
ETIM 5.0	EC002638
ETIM 6.0	EC002638
ETIM 7.0	EC002638

UNSPSC

UNSPSC 6.01	30211810
-------------	----------

Plug - MCVU 1,5/16-GFD-3,81 - 1833166

Classifications

UNSPSC

UNSPSC 7.0901	39121409
UNSPSC 11	39121409
UNSPSC 12.01	39121409
UNSPSC 13.2	39121409
UNSPSC 18.0	39121409
UNSPSC 19.0	39121409
UNSPSC 20.0	39121409
UNSPSC 21.0	39121409

Approvals

Approvals

Approvals

CSA / IECCE CB Scheme / VDE Gutachten mit Fertigungsüberwachung / EAC / cULus Recognized

Ex Approvals

Approval details

CSA		http://www.csagroup.org/services-industries/product-listing/	13631
	B	D	
Nominal voltage UN	300 V	300 V	
Nominal current IN	8 A	8 A	
mm ² /AWG/kcmil	28-16	28-16	

IECEE CB Scheme		http://www.iecee.org/	DE1-60987-B1B2
Nominal voltage UN	160 V		
Nominal current IN	8 A		
mm ² /AWG/kcmil	0.2-1.5		

Plug - MCVU 1,5/16-GFD-3,81 - 1833166

Approvals

VDE Gutachten mit Fertigungsüberwachung		http://www2.vde.com/de/Institut/Online-Service/VDE-gepruefteProdukte/Seiten/Online-Suche.aspx	40011723
Nominal voltage UN	160 V		
Nominal current IN	8 A		
mm ² /AWG/kcmil	0.2-1.5		

EAC		B.01742
-----	--	---------

cULus Recognized		http://database.ul.com/cgi-bin/XYV/template/LISEXT/1FRAME/index.htm	E60425-20110128
	B	D	
Nominal voltage UN	300 V	300 V	
Nominal current IN	8 A	8 A	
mm ² /AWG/kcmil	30-14	30-14	

Accessories

Accessories

Coding element

Coding profile - CP-MSTB - 1734634



Coding profile, is inserted into the slot on the plug or inverted header, red insulating material

Labeled terminal marker

Marker card - SK 3,81/2,8:FORTL.ZAHLEN - 0804109



Marker card, Card, white, labeled, Horizontal: consecutive numbers 1 ... 10, 11 ... 20, etc. up to 91 ... (99)100, mounting type: adhesive, for terminal block width: 3.81 mm, lettering field size: 3.81 x 2.8 mm

Plug - MCVU 1,5/16-GFD-3,81 - 1833166

Accessories

Screwdriver tools

Screwdriver - SZS 0,4X2,5 VDE - 1205037



Screwdriver, slot-headed, VDE insulated, size: 0.4 x 2.5 x 80 mm, 2-component grip, with non-slip grip

Additional products

Printed-circuit board connector - MCVR 1,5/16-STF-3,81 - 1828485



PCB connector, nominal current: 8 A, rated voltage (III/2): 160 V, Nominal cross section: 1.5 mm², number of positions: 16, pitch: 3.81 mm, connection method: Screw connection with tension sleeve, color: green, contact surface: Tin

Printed-circuit board connector - QC 0,5/16-STF-3,81 - 1897681

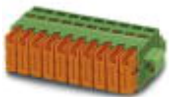

PCB connector, nominal current: 6 A, rated voltage (III/2): 200 V, Nominal cross section: 0.5 mm², number of positions: 16, pitch: 3.81 mm, connection method: Displacement connection, color: green, contact surface: Tin

Printed-circuit board connector - MC 1,5/16-STF-3,81 - 1827842



PCB connector, nominal current: 8 A, rated voltage (III/2): 160 V, Nominal cross section: 1.5 mm², number of positions: 16, pitch: 3.81 mm, connection method: Screw connection with tension sleeve, color: green, contact surface: Tin

Plug - MCVU 1,5/16-GFD-3,81 - 1833166

Accessories

Printed-circuit board connector - FK-MCP 1,5/16-STF-3,81 - 1851371

PCB connector, nominal current: 8 A, rated voltage (III/2): 160 V, Nominal cross section: 1.5 mm², number of positions: 16, pitch: 3.81 mm, connection method: Push-in spring connection, color: green, contact surface: Tin

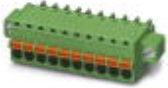

Printed-circuit board connector - MCC 1/16-STZF-3,81 - 1852503

PCB connector, nominal current: 8 A, rated voltage (III/2): 160 V, Nominal cross section: 1 mm², number of positions: 16, pitch: 3.81 mm, connection method: Crimp connection, color: green, Corresponding female crimp contacts with current [A] and conductor cross section range [mm²] data: 5A/MCC-MT 0,2-0,35 (1859988); 8A/MCC-MT 0,5-1,0 (1859991)



Printed-circuit board connector - FRONT-MC 1,5/16-STF-3,81 - 1850990

PCB connector, nominal current: 8 A, rated voltage (III/2): 160 V, Nominal cross section: 1.5 mm², number of positions: 16, pitch: 3.81 mm, connection method: Front screw connection, color: green, contact surface: Tin



Printed-circuit board connector - MCVW 1,5/16-STF-3,81 - 1828634

PCB connector, nominal current: 8 A, rated voltage (III/2): 160 V, Nominal cross section: 1.5 mm², number of positions: 16, pitch: 3.81 mm, connection method: Screw connection with tension sleeve, color: green, contact surface: Tin

