

Flush-type connector - SACC-DSI-M 8FS-4CON-M12/0,5 - 1453452

Please be informed that the data shown in this PDF Document is generated from our Online Catalog. Please find the complete data in the user's documentation. Our General Terms of Use for Downloads are valid (<http://phoenixcontact.com/download>)



Sensor/actuator flush-type socket, 4-pos., M8, rear/screw mounting with M12 thread, with 0.5 m TPE litz wire, 4 x 0.25 mm²

Your advantages

- ✓ Pre-assembled with litz wires for immediate use
- ✓ Customer-specific assemblies and litz wire lengths available
- ✓ Sealed on the litz wire side for optimum leak-tightness
- ✓ Standard pin assignments and codings for signal transmission with a uniform design-in design

Key Commercial Data

Packing unit	1 pc
GTIN	
GTIN	4046356554404
Weight per Piece (excluding packing)	20.000 g
Custom tariff number	85444290
Country of origin	Germany

Technical data

Dimensions

Length of cable	0.5 m
-----------------	-------

Ambient conditions

Ambient temperature (operation)	-25 °C ... 85 °C (Socket)
Degree of protection	IP67

General

Flush-type connector - SACC-DSI-M 8FS-4CON-M12/0,5 - 1453452

Technical data

General

Rated current at 40°C	4 A
Rated voltage	50 V AC 60 V DC
Rated surge voltage	1.5 kV
Number of positions	4
Insulation resistance	≥ 100 MΩ
Coding	A - standard
Standards/regulations	M8 connector IEC 61076-2-104
Status display	No
Overvoltage category	II
Degree of pollution	3
Connection method	Individual wires
Torque	1 Nm ... 1.5 Nm (Installation-side)
Mounting type	Rear mounting M12 x 1 With flat nut

Material

Flammability rating according to UL 94	HB
Contact material	Cu alloy
Contact surface material	Au
Contact carrier material	PUR / PA 6.6
Material, knurls	Nickel-plated brass
Sealing material	FKM
Additional material specifications	EP (Grout material)

Cable

Cable type	PVC litz wire
Conductor cross section	0.25 mm ²
AWG signal line	24
Conductor structure signal line	7x 0.20 mm
Core diameter including insulation	1.5 mm ±0.1 mm
Thickness, insulation	0.21 mm
Wire colors	brown, white, blue, black
Material conductor insulation	PVC / UL
Conductor material	Tin-plated Cu litz wires
Standards/specifications	M8 connector IEC 61076-2-104
Insulation resistance	≥ 20 MΩ*km
Conductor resistance	≥ 80 Ω/km
Nominal voltage, cable	300 V

Flush-type connector - SACC-DSI-M 8FS-4CON-M12/0,5 - 1453452

Technical data

Cable

Test voltage, cable	2000 V AC
Ambient temperature (operation)	-40 °C ... 105 °C (cable, fixed installation)
	-10 °C ... 105 °C (cable, flexible installation)

Standards and Regulations

Standard designation	M8 connector
Standards/regulations	IEC 61076-2-104
Flammability rating according to UL 94	HB

Environmental Product Compliance

China RoHS	Environmentally Friendly Use Period = 25;
	For details about hazardous substances go to tab "Downloads", Category "Manufacturer's declaration"

Drawings

Flush-type connector - SACC-DSI-M 8FS-4CON-M12/0,5 - 1453452

Dimensional drawing

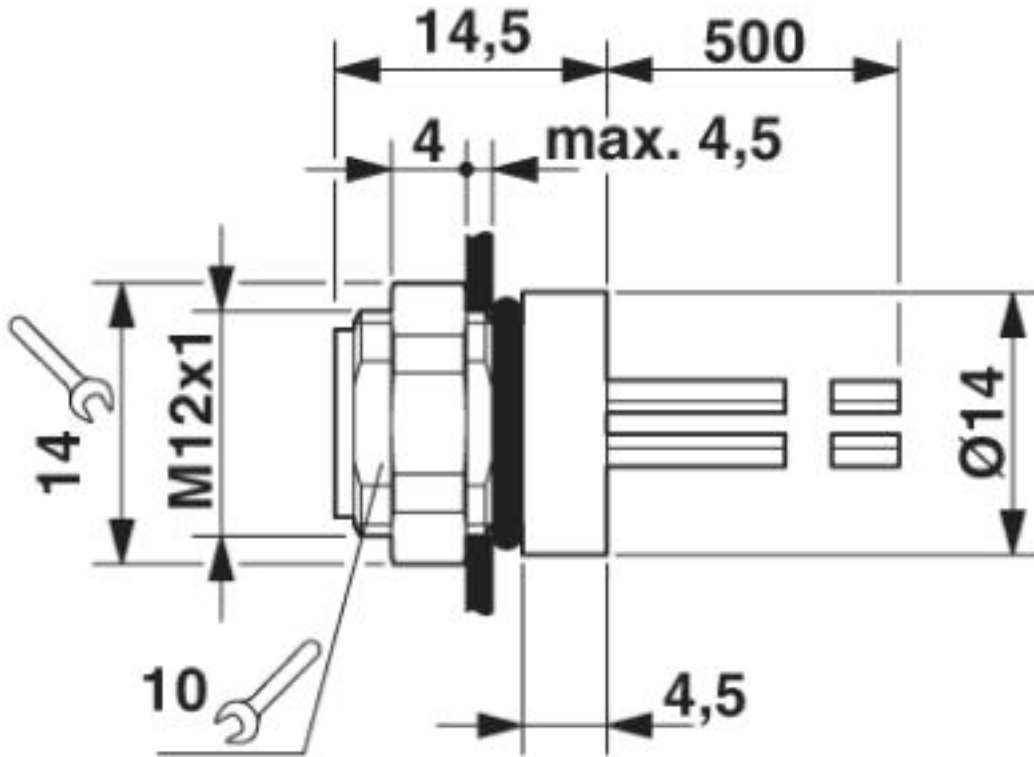

M8 flush-type socket

Flush-type connector - SACC-DSI-M 8FS-4CON-M12/0,5 - 1453452

Dimensional drawing

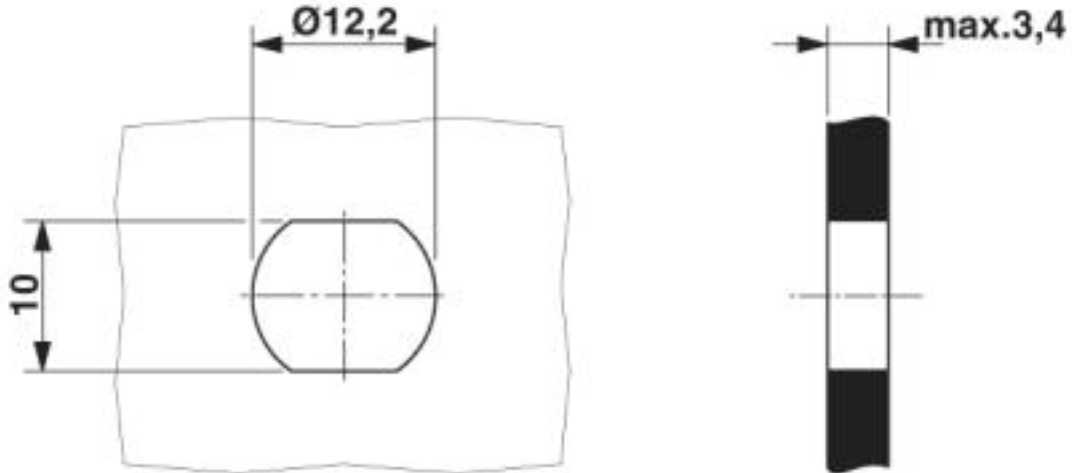

Housing cutout for M8 flush-type connector, socket, one-section

Circuit diagram

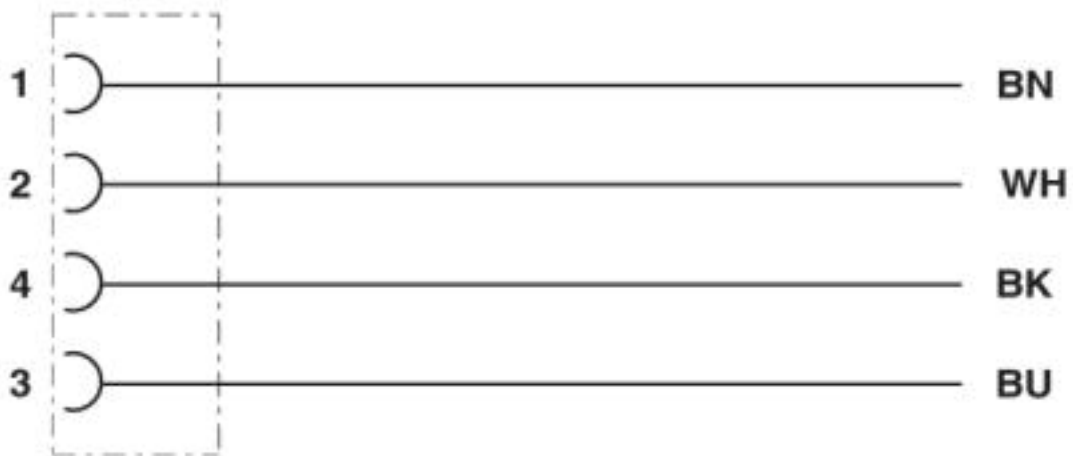

Contact assignment of M8 plugs/sockets

Flush-type connector - SACC-DSI-M 8FS-4CON-M12/0,5 - 1453452

Schematic diagram

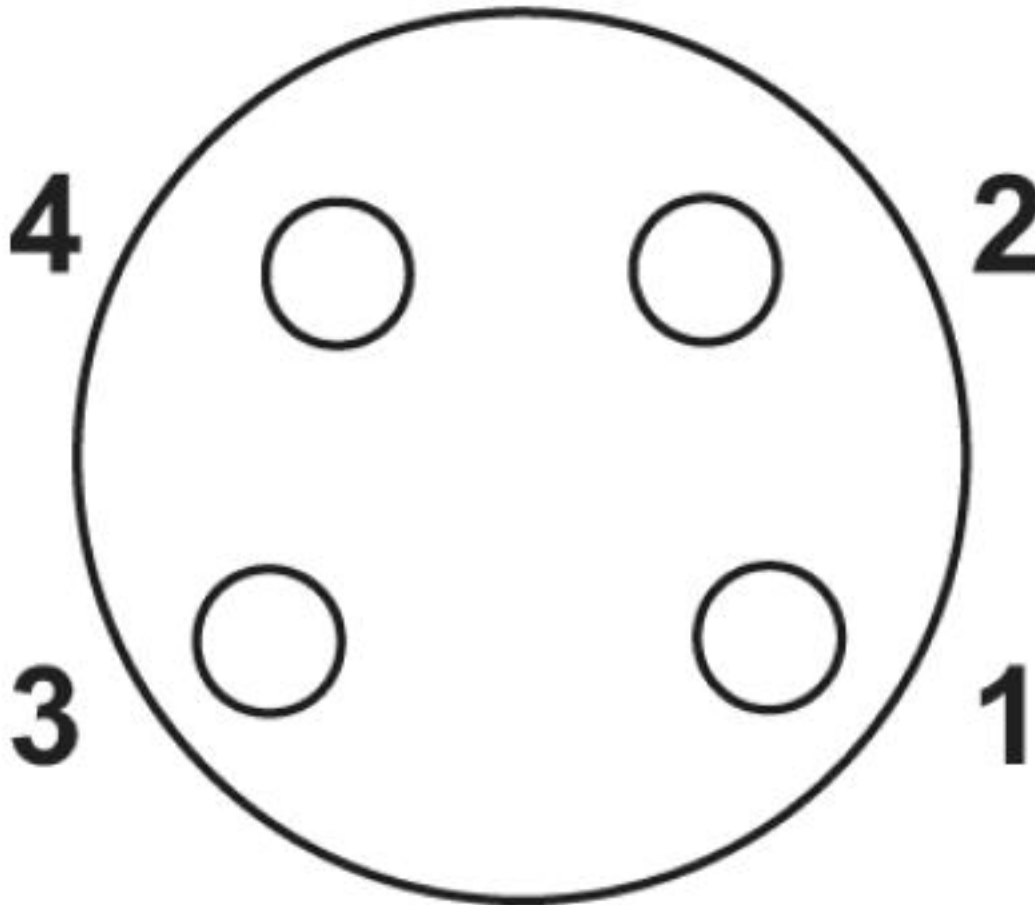

Pin assignment M8 socket, 4-pos., view female side

Classifications

eCl@ss

eCl@ss 10.0.1	27440102
eCl@ss 4.0	27260700
eCl@ss 4.1	27260700
eCl@ss 5.0	27260700
eCl@ss 5.1	27260700
eCl@ss 6.0	27279200
eCl@ss 7.0	27440103
eCl@ss 8.0	27440103

Flush-type connector - SACC-DSI-M 8FS-4CON-M12/0,5 - 1453452

Classifications

eCl@ss

eCl@ss 9.0	27440102
------------	----------

ETIM

ETIM 3.0	EC002061
ETIM 4.0	EC002061
ETIM 5.0	EC002061
ETIM 6.0	EC002061

UNSPSC

UNSPSC 6.01	31251501
UNSPSC 7.0901	31251501
UNSPSC 11	31251501
UNSPSC 12.01	31251501
UNSPSC 13.2	39121413

Approvals

Approvals

Approvals

UL Recognized / cUL Recognized / EAC / EAC / cULus Recognized

Ex Approvals

Approval details

UL Recognized		http://database.ul.com/cgi-bin/XYV/template/LISEXT/1FRAME/index.htm	FILE E 221474
Nominal voltage UN	30 V		
Nominal current IN	4 A		
mm ² /AWG/kcmil	24		

Flush-type connector - SACC-DSI-M 8FS-4CON-M12/0,5 - 1453452

Approvals

cUL Recognized		http://database.ul.com/cgi-bin/XYV/template/LISEXT/1FRAME/index.htm	FILE E 221474
Nominal voltage UN		30 V	
Nominal current IN		4 A	
mm ² /AWG/kcmil		24	

EAC		B.01742
-----	---	---------

EAC		B.00767
-----	---	---------

cULus Recognized	
------------------	---