

## Network cable - NBC-MS/20,0-94B/R4AC SCO US - 1417873

Please be informed that the data shown in this PDF Document is generated from our Online Catalog. Please find the complete data in the user's documentation. Our General Terms of Use for Downloads are valid (<http://phoenixcontact.com/download>)



Network cable, Ethernet CAT5 (1 Gbps), 8-position, PUR halogen-free, water blue RAL 5021, shielded, Plug straight M12 SPEEDCON / IP67, Coding: A, on Plug straight RJ45 / IP20, Cable length: 20 m



### Key Commercial Data

Packing unit	1 STK
GTIN	 4 055626 268415
GTIN	4055626268415
Weight per Piece (excluding packing)	1,020.000 g
Custom tariff number	85444290
Country of origin	United States

### Technical data

#### Dimensions

Length of cable	20 m
-----------------	------

#### Ambient conditions

Degree of protection	IP65 (M12 connector)
	IP67 (M12 connector)
	IP20 (RJ45 connector)
Ambient temperature (operation)	-25 °C ... 85 °C (M12 connector)

#### General data

Rated current at 40°C	1 A
Rated voltage	30 V
Number of positions	8

# Network cable - NBC-MS/20,0-94B/R4AC SCO US - 1417873

## Technical data

### General data

Signal type/category	Ethernet CAT5 (IEC 11801), 1 Gbps
Standards/regulations	M12 connector IEC 61076-2-101

### Characteristics head 1

Head type	Plug straight M12 SPEEDCON / IP67
Coding	A (Standard)

### Characteristics head 2

Head type	Plug straight RJ45 / IP20
-----------	---------------------------

### Standards and Regulations

Standard designation	M12 connector
Standards/regulations	IEC 61076-2-101

### Cable

Cable type	Ethernet, flexible, CAT5
Cable type (abbreviation)	94B
UL AWM style	20963 (80°C/30 V)
Signal type/category	Ethernet CAT5 (IEC 11801), 1 Gbps
Cable structure	4x2xAWG26/7; SF/UTP
Conductor cross section	4x 2x 0.14 mm <sup>2</sup>
AWG signal line	26
Conductor structure signal line	7x 0.16 mm
Core diameter including insulation	0.96 mm
Wire colors	white/blue-blue, white/orange-orange, white/green-green, white/brown-brown
Twisted pairs	2 cores to the pair
Overall twist	4 pairs for core
Shielding	Aluminum-coated foil, tinned copper braided shield
Optical shield covering	70 %
External sheath, color	water blue RAL 5021
Outer sheath thickness	1.05 mm
External cable diameter D	6.4 mm ±0.2 mm
Minimum bending radius, fixed installation	4 x D
Minimum bending radius, flexible installation	8 x D
Tensile strength short-term/long-term	≤ 100 N
Cable weight	47 kg/km
Outer sheath, material	PUR
Material conductor insulation	Foamed PE
Conductor material	Bare Cu litz wires

# Network cable - NBC-MS/20,0-94B/R4AC SCO US - 1417873

## Technical data

### Cable

Insulation resistance	≥ 500 MΩ*km
Loop resistance	≤ 290 Ω (per km)
Cable capacity	48 nF/km (at 1 kHz)
Wave impedance	100 Ω ±5 Ω (at 100 MHz)
Signal runtime	5.3 ns/m
Coupling resistance	≤ 100.00 mΩ/m (At 10 MHz)
Nominal voltage, cable	≤ 100 V
Test voltage Core/Core	700 V (50 Hz, 1 min.)
Test voltage Core/Shield	700 V (50 Hz, 1 min.)
Flame resistance	according to IEC 60332-1-2
Halogen-free	According to IEC 60754-1
Resistance to oil	according to EN 60811-2-1
Ambient temperature (operation)	-40 °C ... 80 °C (cable, fixed installation)
	-20 °C ... 80 °C (cable, flexible installation)
Ambient temperature (installation)	-20 °C ... 80 °C
Ambient temperature (storage/transport)	-20 °C ... 80 °C

## Drawings

Schematic diagram

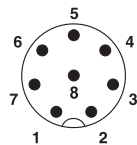

Pin assignment M12 plug, 8-pos., A-coded, view plug side

Schematic diagram

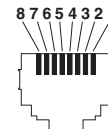

Connector pin assignment plug RJ45

# Network cable - NBC-MS/20,0-94B/R4AC SCO US - 1417873

Cable cross section



Dimensional drawing

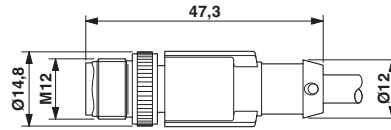

Ethernet, flexible, CAT5 [94B]

Plug, M12 x 1, straight, shielded

Dimensional drawing

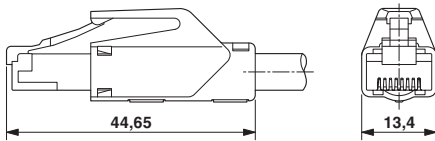

Circuit diagram

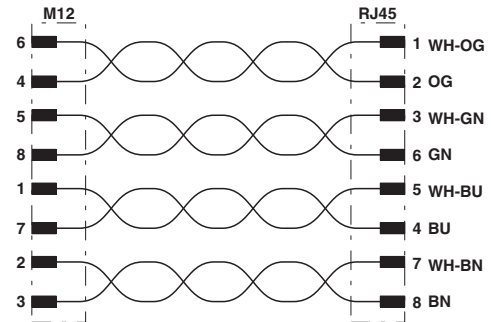

RJ45 connector, IP20

Contact assignment of the M12 and RJ45 plug

## Classifications

eCl@ss

eCl@ss 4.0	27060306
eCl@ss 4.1	27060306
eCl@ss 5.0	27061801
eCl@ss 5.1	27061801
eCl@ss 6.0	27061801
eCl@ss 7.0	27061801
eCl@ss 8.0	27279218
eCl@ss 9.0	27060311

ETIM

ETIM 5.0	EC001855
ETIM 6.0	EC001855

# Network cable - NBC-MS/20,0-94B/R4AC SCO US - 1417873

## Classifications

### UNSPSC

UNSPSC 13.2	31251501
-------------	----------

## Approvals

### Approvals

---

### Approvals

### UL Listed

---

### Ex Approvals

---

## Approval details

UL Listed		<a href="http://database.ul.com/cgi-bin/XYV/template/LISEXT/1FRAME/index.htm">http://database.ul.com/cgi-bin/XYV/template/LISEXT/1FRAME/index.htm</a>	FILE E 335024
Nominal current IN		0.5 A	
Nominal voltage UN		30 V	