

D1G133-DC13-52

EC centrifugal fan

forward curved, dual inlet
with housing (without flange)



ebm-papst Mulfingen GmbH & Co. KG

Bachmühle 2 · D-74673 Mulfingen

Phone +49 7938 81-0

Fax +49 7938 81-110

info1@de.ebmpapst.com

www.ebmpapst.com

Limited partnership · Headquarters Mulfingen
County court Stuttgart · HRA 590344

General partner Elektrobau Mulfingen GmbH · Headquarters Mulfingen
County court Stuttgart · HRB 590142

Nominal data

Type	D1G133-DC13-52	
Motor	M1G074-CF	
Nominal voltage	VDC	24
Nominal voltage range	VDC	16 .. 28
Frequency	Hz	-
Type of data definition		fa
Speed	min ⁻¹	1580
Power input	W	118
Current draw	A	6.0
Min. ambient temperature	°C	-25
Max. ambient temperature	°C	60

ml = Max. load · me = Max. efficiency · fa = Running at free air · cs = Customer specs · cu = Customer unit
Subject to alterations



EC centrifugal fan

forward curved, dual inlet
with housing (without flange)

Technical features

Mass	3.46 kg
Size	133 mm
Surface of rotor	Coated in black
Material of impeller	Sheet steel, hot-galvanised
Housing material	Sheet steel, hot-galvanised
Motor suspension	Motor anti-vibration mounted on both sides
Direction of rotation	Clockwise, seen on rotor
Type of protection	IP 42
Insulation class	"B"
Humidity class	F0
Max. permissible ambient motor temp. (transp./ storage)	+ 80 °C
Min. permissible ambient motor temp. (transp./storage)	- 40 °C
Mounting position	Any
Condensate discharge holes	None
Operation mode	S1
Motor bearing	Ball bearing
Technical features	<ul style="list-style-type: none"> - Control input 0-10 VDC / PWM - Tach output - Motor current limit - Soft start
EMC interference immunity	Acc. to EN 61000-6-2 (industrial environment)
EMC interference emission	Acc. to EN 55022 (Class B)
Motor protection	Reverse polarity and locked-rotor protection
Cable exit	Variable
Product conforming to standard	EN 60950-1
Approval	CSA C22.2 Nr.77; EAC; UL 1004-1



D1G133-DC13-52

EC centrifugal fan

forward curved, dual inlet
with housing (without flange)

Product drawing

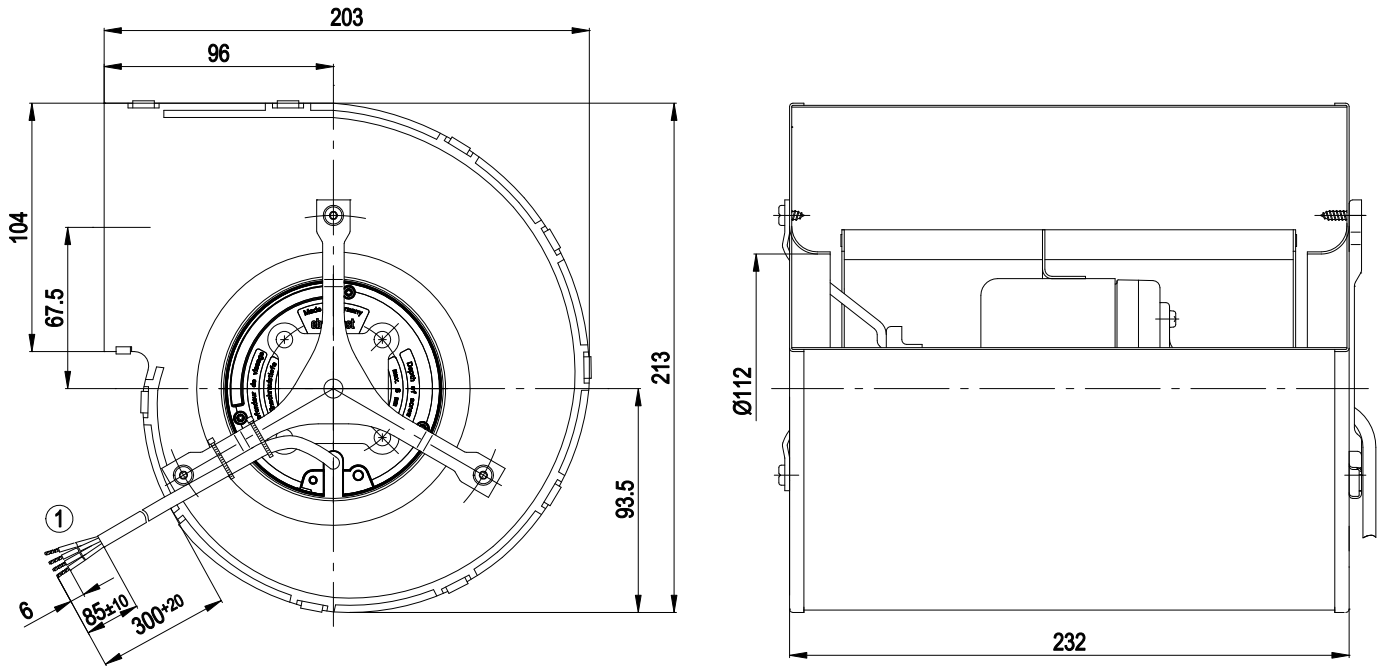

1 Connection line PVC AWG20, 4x brass lead tips crimped



EC centrifugal fan

forward curved, dual inlet
with housing (without flange)

Connection screen

Customer circuit

Full speed

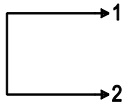

Speed setting

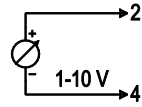

10 V → n = max
1 V → n = min
<1 V → n = 0
Safe start
at Unom -30%
from 4 V Ucontr.

Speed setting via potentiometer

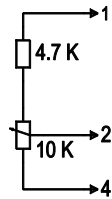

Speed setting via PWM 1-10 kHz

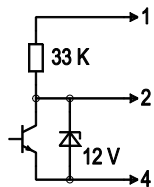

100% PWM → n = max
10% PWM → n = min
<10% PWM → n = 0
Safe start
at Unom -30%
from 40% PWM

Set value via temperature controller

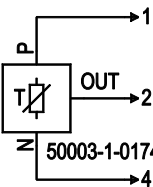

T < 10°C → n = 0
T > 45°C → n = max

Connection

Fan / motor

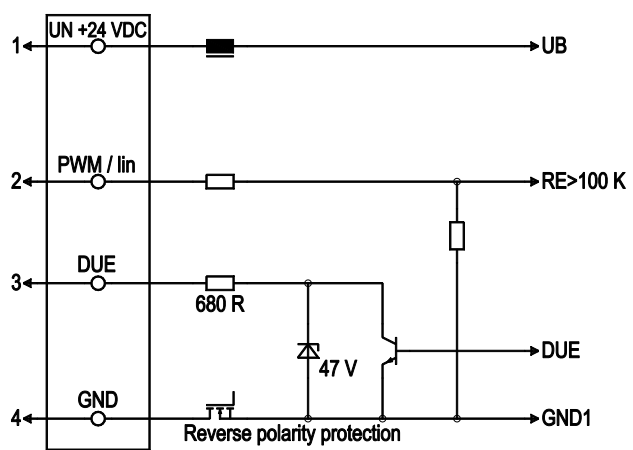

No.	Conn.	Designation	Colour	Function / assignment
1	1	Un +24V	red	Power supply 24 VDC, residual ripple 3.5 %
1	2	PWM / lin	yellow	PWM / lin, control input, 0-10 V
1	3	Tach	white	Speed monitoring output, 3 pulses per revolution, Isink max = 10 mA
1	4	GND	blue	Reference mass



EC centrifugal fan

forward curved, dual inlet
with housing (without flange)

Charts: Air flow

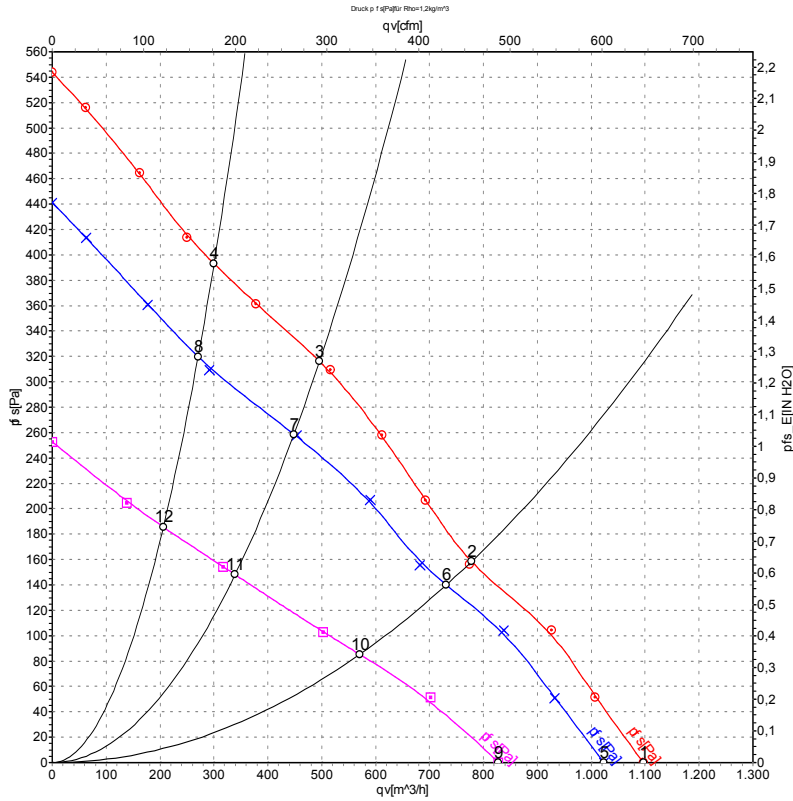

Air performance measured as per ISO 5801 Installation category A. For detailed information on the measuring set-up, please contact ebmpapst. Suction-side noise levels: L_{WA} measured as per ISO 13347 / L_{pA} measured with 1m distance to fan axis. The values given are valid under the measuring conditions mentioned above and may vary according to the actual installation situation. With any deviation from the standard set-up, the specific values have to be checked and reviewed with the unit installed.

Measured values

	U	n	P _{ed}	I	qv	p _{fs}
	V	min ⁻¹	W	A	m ³ /h	Pa
1	28	1675	147	6.46	1095	0
2	28	2080	128	5.21	780	155
3	28	2495	111	4.37	495	317
4	28	2715	95	3.73	300	393
5	24	1580	118	6.00	1020	0
6	24	1930	105	4.91	730	140
7	24	2265	83	3.84	450	260
8	24	2455	70	3.28	270	320
9	16	1290	66	4.59	830	0
10	16	1510	52	3.58	570	85
11	16	1730	39	2.84	340	148
12	16	1870	34	2.65	205	185

U = Supply voltage · n = Speed · P_{ed} = Power input · I = Current draw · qv = Air flow · p_{fs} = Pressure increase

