

Industrial Ethernet Connectors XS5□-T / XS6□

Cables and Connectors for EtherCAT® and Other Industrial Ethernet Networks.

CAT6a Ethernet patch cables

- For in-cabinet use
- LSZH with standard RJ45 plugs

CAT5e Ethernet patch cables

- For out-of-cabinet use
- PUR with standard RJ45 plugs
- PVC with rugged RJ45 plugs and/or M12 SmartClick plugs or sockets



Smartclick™

Connection Examples

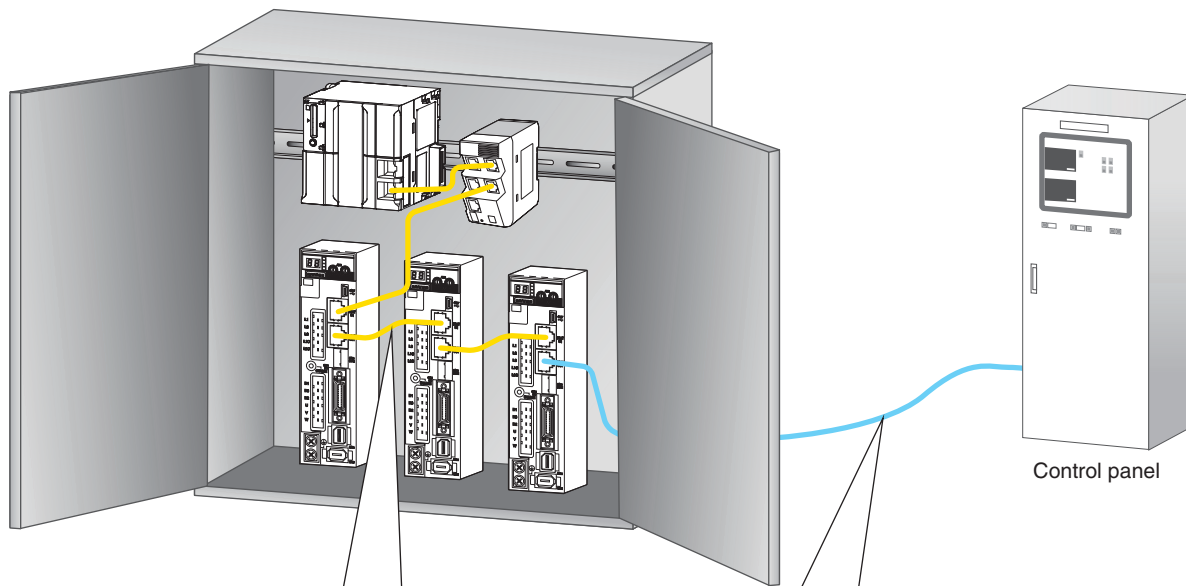

Ideal for in-cabinet
XS6W-6LSZH

Standard Connectors

Ideal for out-of-cabinet
XS6W-5PUR

XS5

Standard Connectors Rugged Connectors M12 Connectors Straight Plugs M12 Connectors Right-angle Plugs M12 Connectors Straight Sockets

Features

■ Cables with Standard RJ45 Connectors

- The lineup features LSZH cables* for in-panel wiring and PUR cables for wiring outside of panels.
- The standard RJ45 Connectors reduce cable routing space.
 - Outer diameter: 5.8 mm
 - 4-pair AWG27 (LSZH) or AWG26 (PUR)
- Cable colors include blue, yellow, or green.
- LSZH cables are available in 12 lengths from 0.2 to 20 m and PUR cables are available in 10 lengths from 0.5 to 20 m.
- Double-shielded cables with overall braiding and individual foil shield on each wire pair to reduce EMC interference in industrial environments.

*Low-smoke zero-halogen cables

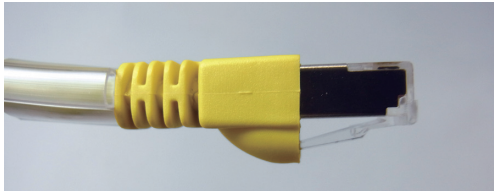
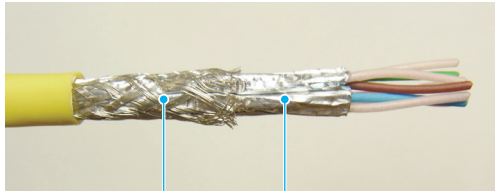
Shape of RJ45 Connector	LSZH Cable with Double Shield
	 <p data-bbox="870 779 1349 800">Overall braiding and individual foil shield on each wire pair</p>

■ Cables with Rugged RJ45 Connectors

- Tough latches and RJ45 connectors with strong cable holding strength are used to enable connectors outside of control panels.
- Quad AWG22 cable with PVC cover of 6.5 mm outer diameter.
- Double-shielded cables with overall braiding and individual foil shield to reduce EMC interference in industrial environments.

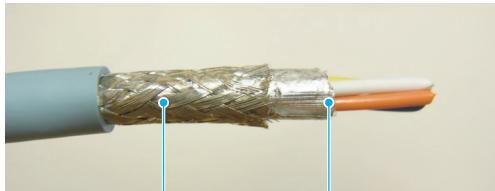
Shape of RJ45 Connector	PVC Cable with Double Shield
 <p data-bbox="358 1262 459 1283">Tough latch</p>	 <p data-bbox="935 1262 1268 1283">Overall braiding and individual foil shield</p>

Cable Extension Length

Standard Connectors (RJ45 Connectors)

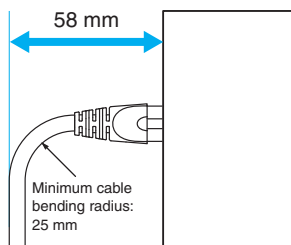

Rugged Connectors (RJ45 Connectors)

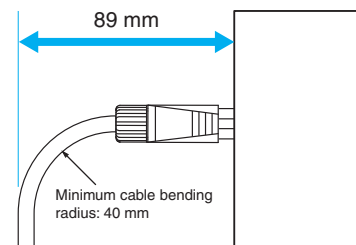

■ Cables with M12 Connectors

- Resistant to harsh environments with IP67 protection.
- SmartClick Connectors that provide one-step (1/8th turn) connection are used (compatible with standard M12 screw connectors).
- A wide range of variations, such as cables with right-angle connectors and PCB connectors.

• SmartClick is a registered trademark of OMRON Corporation.
 • EtherCAT® is a registered trademark and patented technology, licensed by Beckhoff Automation GmbH, Germany.

Cables with Standard RJ45 Connectors

Specifications

Type	Cable with Connector on Both Ends (RJ45/RJ45)/LSZH	Cable with Connectors on Both Ends (RJ45/RJ45)/PUR
Item / Model	XS6W-6LSZH8SS□□□□CM-□	XS6W-5PUR8SS□□□□CM-G
Rated current	1 A (@ 50°C)	
Withstand voltage	1,000 VDC for 60 s (leak current: 1 mA max.)	
Ambient operating temperature	- 20 to 60°C	- 40 to 85°C
Ambient storage temperature	- 20 to 60°C	- 40 to 85°C
Ambient installation temperature	0 to 50°C	- 10 to 60°C
Protective structure	IP20	

Materials and Finish

Connectors

Type	Cable with Connector on Both Ends (RJ45/RJ45)/LSZH	Cable with Connectors on Both Ends (RJ45/RJ45)/PUR
Item / Model	XS6W-6LSZH8SS□□□□CM-□	XS6W-5PUR8SS□□□□CM-G
Connector housing	PC resin (UL94V-0) / transparent	
Contacts	Phosphor bronze / nickel base, gold plated (0.8 μm)	
Shield	Brass/nickel plated	
Cover (Structured to prevent the tab from breaking)	LSZH: Blue, yellow or green	PUR: Green
Marking tube	PVC Resin (UL94V-0) / transparent	

Cable

Type	Cable with Connector on Both Ends (RJ45/RJ45)/LSZH	Cable with Connectors on Both Ends (RJ45/RJ45)/PUR
Item / Model	XS6W-6LSZH8SS□□□□CM-□	XS6W-5PUR8SS□□□□CM-G
Compliant standard	IEC 60332-1 / UL1581 FT2	
Number of cores/gauge	4 x 2 x AWG27 0.1 mm ²	4 x 2 x AWG26 0.13 mm ²
Outer diameter *1	5.8 mm	
Sheath color *2	Blue, yellow or green	Green
Sheath material	LSZH	PUR
Shield structure	Double shield S/FTP	Double shield SF/UTP

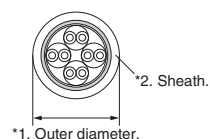

XS6W - Plugs on Both Cable Ends





XS6W-□□8SS□CM-□ (2 x standard RJ45)

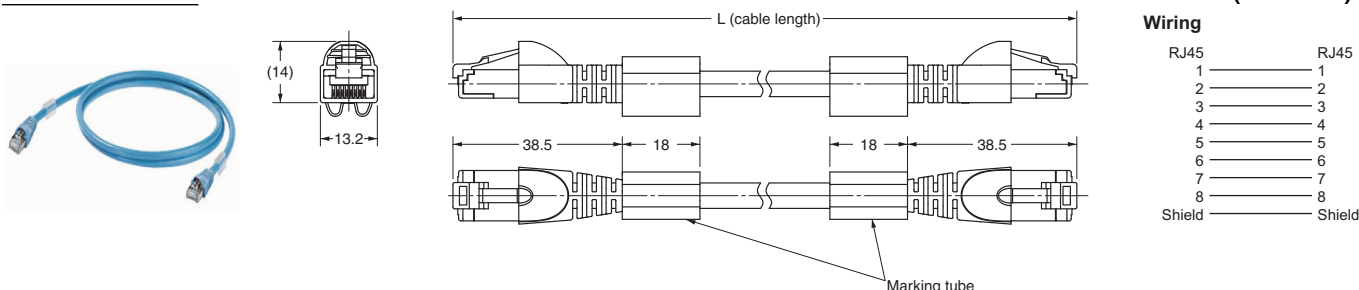

Dimensions



Ordering Information

Appearance	Type	Category	Cable sheath material	Cable color	Cable length L (m)	Model
	Cable with Connector on Both Ends (Standard RJ45 / RJ45)	Cat.6a	LSZH	Blue	0.2	XS6W-6LSZH8SS20CM-B
					0.3	XS6W-6LSZH8SS30CM-B
					0.5	XS6W-6LSZH8SS50CM-B
					1	XS6W-6LSZH8SS100CM-B
					1.5	XS6W-6LSZH8SS150CM-B
					2	XS6W-6LSZH8SS200CM-B
					3	XS6W-6LSZH8SS300CM-B
					5	XS6W-6LSZH8SS500CM-B
					7.5	XS6W-6LSZH8SS750CM-B
					10	XS6W-6LSZH8SS1000CM-B
					15	XS6W-6LSZH8SS1500CM-B
					20	XS6W-6LSZH8SS2000CM-B
				Yellow	0.2	XS6W-6LSZH8SS20CM-Y
					0.3	XS6W-6LSZH8SS30CM-Y
					0.5	XS6W-6LSZH8SS50CM-Y
					1	XS6W-6LSZH8SS100CM-Y
					1.5	XS6W-6LSZH8SS150CM-Y
					2	XS6W-6LSZH8SS200CM-Y
					3	XS6W-6LSZH8SS300CM-Y
					5	XS6W-6LSZH8SS500CM-Y
					7.5	XS6W-6LSZH8SS750CM-Y
					10	XS6W-6LSZH8SS1000CM-Y
					15	XS6W-6LSZH8SS1500CM-Y
					20	XS6W-6LSZH8SS2000CM-Y
	Green	0.2	XS6W-6LSZH8SS20CM-G			
		0.3	XS6W-6LSZH8SS30CM-G			
		0.5	XS6W-6LSZH8SS50CM-G			
		1	XS6W-6LSZH8SS100CM-G			
		1.5	XS6W-6LSZH8SS150CM-G			
		2	XS6W-6LSZH8SS200CM-G			
		3	XS6W-6LSZH8SS300CM-G			
		5	XS6W-6LSZH8SS500CM-G			
		7.5	XS6W-6LSZH8SS750CM-G			
		10	XS6W-6LSZH8SS1000CM-G			
		15	XS6W-6LSZH8SS1500CM-G			
		20	XS6W-6LSZH8SS2000CM-G			
	Cat.5	PUR	Green	0.5	XS6W-5PUR8SS50CM-G	
				1	XS6W-5PUR8SS100CM-G	
				1.5	XS6W-5PUR8SS150CM-G	
				2	XS6W-5PUR8SS200CM-G	
				3	XS6W-5PUR8SS300CM-G	
				5	XS6W-5PUR8SS500CM-G	
				7.5	XS6W-5PUR8SS750CM-G	
				10	XS6W-5PUR8SS1000CM-G	
				15	XS6W-5PUR8SS1500CM-G	
				20	XS6W-5PUR8SS2000CM-G	

Model Number Legend

Use this model number legend to identify products from their model number. When ordering, use a model number from the table in *Ordering Information*.

XS6W - **8SS****CM** -
 1 2 3 4

1. Cable Cat.

5: Cat. 5
6: Cat. 6a

2. Cable Sheath Material

LSZH: Low Smoke zero-halogen
PUR: PUR

3. Cable Length

20: 0.2 m 300: 3 m
30: 0.3 m 500: 5 m
50: 0.5 m 750: 7.5 m
100: 1 m 1000: 10 m
150: 1.5 m 1500: 15 m
200: 2 m 2000: 20 m

4. Cable Color

B: Blue
Y: Yellow
G: Green

Cables with Rugged RJ45 Connectors and Cables with M12 Connectors

Specifications

Type	Cable with Plug on One End (M12)	Cable with Plugs on Both Ends (M12/M12)	Cable with Plug on One End and Socket on Other End (M12/M12)	Cable with Plugs on Both Ends (M12/RJ45)	Cable with Plugs on One End and Socket on Other End (M12/Rj45)	Cable with Plugs on Both Ends (RJ45/RJ45)	RJ45 Assembly Connector	M12 Connector for Panel Mounting	M12 Panel-mounting PCB Straight Terminals
Item / Model	XS5H -T42□-□M0-K	XS5W -T42□-□M2-K, -KR	XS5W -T42□-□M1-K, -KR	XS5W -T42□-□MC-K, -KR	XS5W -T42□-□ME-K	XS5W -T42□-□MD-K, -KR	XS6G -T421-1	XS5P -T42□-5	XS5P -T426-1
Rated current	3 A			2.5 A			4 A		
Rated voltage	30 V						125 VDC		
Contact resistance	40 mΩ max.								
Insulation resistance	1,000 MΩ min.				500 MΩ min.			1,000 MΩ min.	
Withstand voltage	1,000 VAC for 60 s (leakage current: 1 mA max.)							1,500 VAC for 60 s (leakage current: 1 mA max.)	
Ambient operating temperature	- 25 to 70°C								
Ambient storage temperature	- 25 to 70°C								
Degree of protection	M12: IEC IP67, RJ45: IEC IP20								IEC IP67

Materials and Finish

Connector

Model	M12			RJ45
Item	XS5H and XS5W	XS5P-T42□-5	XS5P-T426-1	XS5W and XS6G
Contact Block	PBT resin (UL94V-0), light gray		PA resin (UL94V-0), black	PC resin (UL94V-0), black
Contacts	Materials	Phosphor bronze / nickel base		Bronze / nickel base
	Finish	0.4-μm gold-plating		1.4-μm gold-plating
Anchors	Zinc diecast / nickel plating			—
Anchors (tabs)	SUS	—	—	—
Cover	Straight Connector: Soft PBT resin (UL94 V-0)/black Right-angle Connector: TPC resin/black	—	—	—
Sealing resin	—	Epoxy resin	—	—
O-rings	Rubber			—
Grounding Fixture	—	—	Phosphor bronze/nickel base, tin plated (2.0 μm)	—
Anchor Cover	—	—	SUS	—
Nuts	—	Bronze / nickel plated		—

Cable

	Standard Cable	Robot Cable
Compliant standard	UL CM: Cat. 5e PVC (double shield SF/UTP)	
Num. of Cores	AWG22 (7/0.26)	AWG22 (7/24/0.05)
Wire colors	Yellow, orange, white, and blue	
Outer Diameter	6.5 mm *1	
Sheath color	Light blue *2	

Note: For the XS5H and XS5W, cables are available only with the connectors attached.

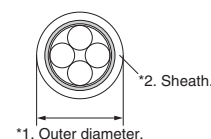

Note: Smartclick™ is a registered trademark of the OMRON Corporation.

4-Pin Connectors with Cable Attached

■ XS5H - Plug on One Cable End

XS5H-T421-□M0-K (1 x M12, Straight)



Dimensions

(Unit: mm)

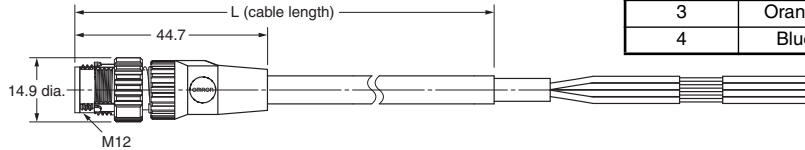

Wiring

Terminal No.	Color
1	Yellow
2	White
3	Orange
4	Blue

Ordering Information

Type	Cable length L (m)	Model
		Standard Cable
Cable with Connector on One End (M12 straight plug)	0.5	XS5H-T421-BM0-K
	1	XS5H-T421-CM0-K
	2	XS5H-T421-DM0-K
	3	XS5H-T421-EM0-K
	5	XS5H-T421-GM0-K
	10	XS5H-T421-JM0-K
	15	XS5H-T421-KM0-K

XS5H-T422-□M0-K (1 x M12, Right Angle)



Dimensions

(Unit: mm)

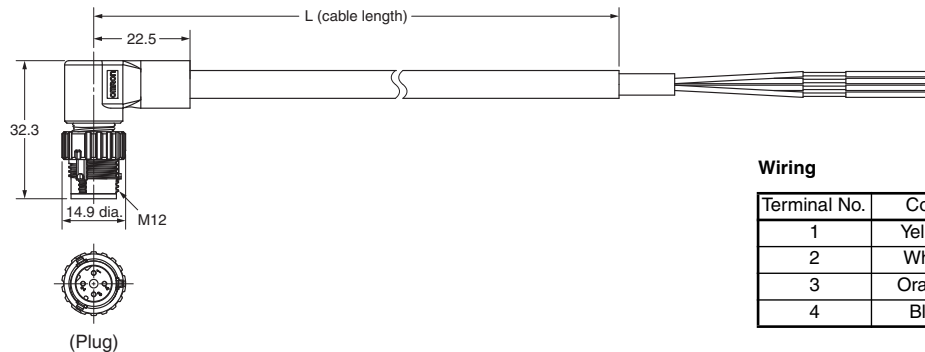

Wiring

Terminal No.	Color
1	Yellow
2	White
3	Orange
4	Blue

Type	Cable length L (m)	Model
		Standard Cable
Cable with Connector on One End (M12 right angle plug)	0.5	XS5H-T422-BM0-K
	1	XS5H-T422-CM0-K
	2	XS5H-T422-DM0-K
	3	XS5H-T422-EM0-K
	5	XS5H-T422-GM0-K
	10	XS5H-T422-JM0-K
	15	XS5H-T422-KM0-K

Note: Ask your OMRON representative about other specifications.

Model Number Legend

Use this model number legend to identify products from their model number. When ordering, use a model number from the table in *Ordering Information*.

XS5H - T42□ - □M□ -K
 1 2 3 4 5 6 7 8 9

1. Type

H: Connector connected to cable, M12 plug on one cable end

2. Signal type

T: Ethernet

3. Connector Poles

4: 4 poles

4. Contact Plating

2: 0.4-μm gold plating - M12 connectors

5. Cable Connection Direction

1: Straight

2: Right Angle

6. Cable Length

A: 0.3 m G: 5 m

B: 0.5 m J: 10 m

C: 1 m K: 15 m

D: 2 m

E: 3 m

7. Connections

M: ① Yellow, ② White, ③ Orange, ④ Blue
 (Numbers inside circles are terminal numbers)

8. Connectors on One End/Both Ends

0: One M12 Plug

9. Cable Specifications

K: UL CM PVC (double shielded) / Cat.5E

■ XS5W - Connectors on Both Cable Ends

XS5W-T421-□M2-K(-KR) (2 x M12, Straight Plugs)



Dimensions

(Unit: mm)

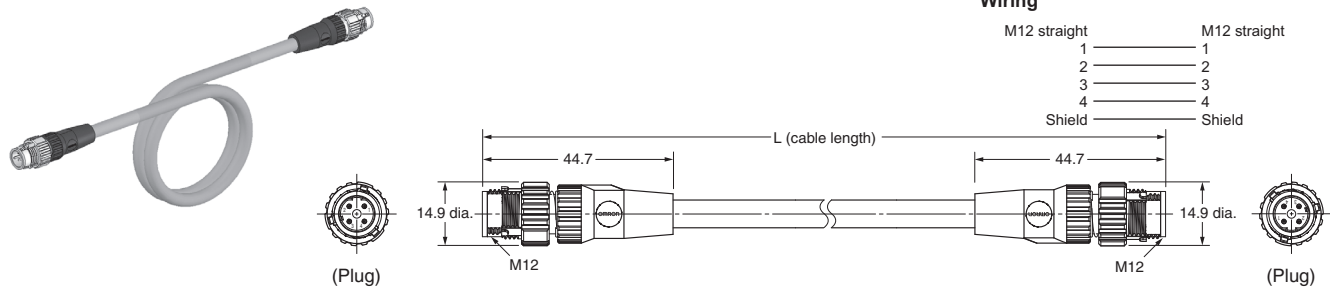

Ordering Information

Type	Cable length L (m)	Model	
		Standard Cable	Robot Cable
Cable with Connector on Both Ends (M12 straight plug / M12 straight plug)	0.5	XS5W-T421-BM2-K	XS5W-T421-BM2-KR
	1	XS5W-T421-CM2-K	XS5W-T421-CM2-KR
	2	XS5W-T421-DM2-K	XS5W-T421-DM2-KR
	3	XS5W-T421-EM2-K	XS5W-T421-EM2-KR
	5	XS5W-T421-GM2-K	XS5W-T421-GM2-KR
	10	XS5W-T421-JM2-K	XS5W-T421-JM2-KR
	15	XS5W-T421-KM2-K	XS5W-T421-KM2-KR

XS5W-T421-□MC-K(-KR) (1x M12, Straight Plug and 1x Rugged RJ45 Plug)



Dimensions

(Unit: mm)

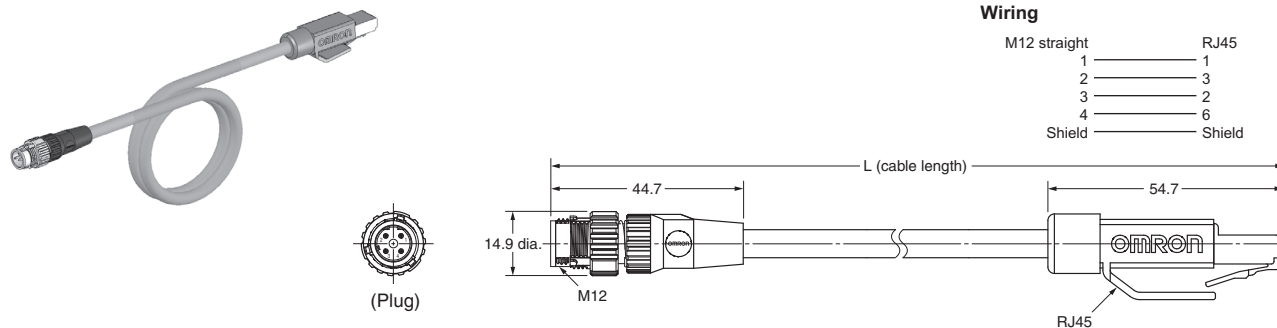

Ordering Information

Type	Cable length L (m)	Model	
		Standard Cable	Robot Cable
Cable with Connector on Both Ends (M12 straight plug/ RJ45 plug)	0.3	XS5W-T421-AMC-K	- - -
	0.5	XS5W-T421-BMC-K	XS5W-T421-BMC-KR
	1	XS5W-T421-CMC-K	XS5W-T421-CMC-KR
	2	XS5W-T421-DMC-K	XS5W-T421-DMC-KR
	3	XS5W-T421-EMC-K	XS5W-T421-EMC-KR
	5	XS5W-T421-GMC-K	XS5W-T421-GMC-KR
	10	XS5W-T421-JMC-K	XS5W-T421-JMC-KR
15	XS5W-T421-KMC-K	XS5W-T421-KMC-KR	

Note: Ask your OMRON representative about other specifications.

XS5W-T421-□M1-K(-KR) (1 x M12, Straight Plug and 1 x M12, Straight Socket)



Dimensions

(Unit: mm)

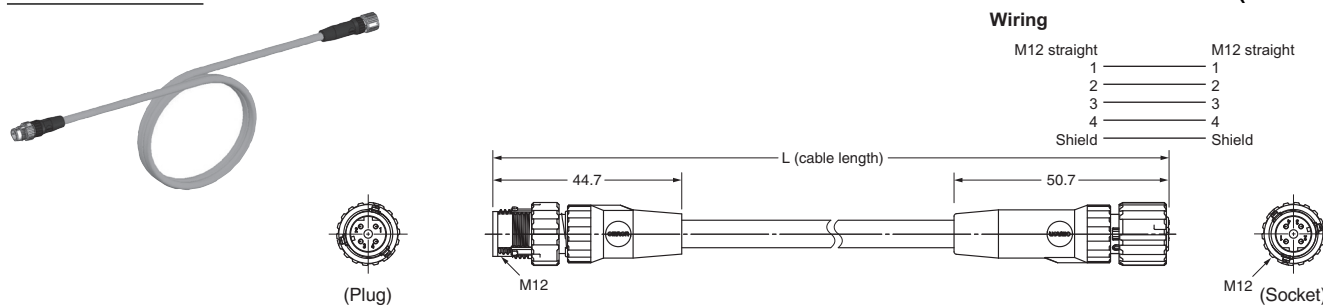

Ordering Information

Type	Cable length L (m)	Model	
		Standard Cable	Robot Cable
Cable with Connector on Both Ends (M12 straight plug / M12 straight socket)	0.5	XS5W-T421-BM1-K	XS5W-T421-BM1-KR
	1	XS5W-T421-CM1-K	XS5W-T421-CM1-KR
	2	XS5W-T421-DM1-K	XS5W-T421-DM1-KR
	3	XS5W-T421-EM1-K	XS5W-T421-EM1-KR
	5	XS5W-T421-GM1-K	XS5W-T421-GM1-KR
	10	XS5W-T421-JM1-K	XS5W-T421-JM1-KR
	15	XS5W-T421-KM1-K	XS5W-T421-KM1-KR

XS5W-T421-□ME-K (1x M12, Straight Socket and 1x Rugged RJ45 Plug)



Dimensions

(Unit: mm)

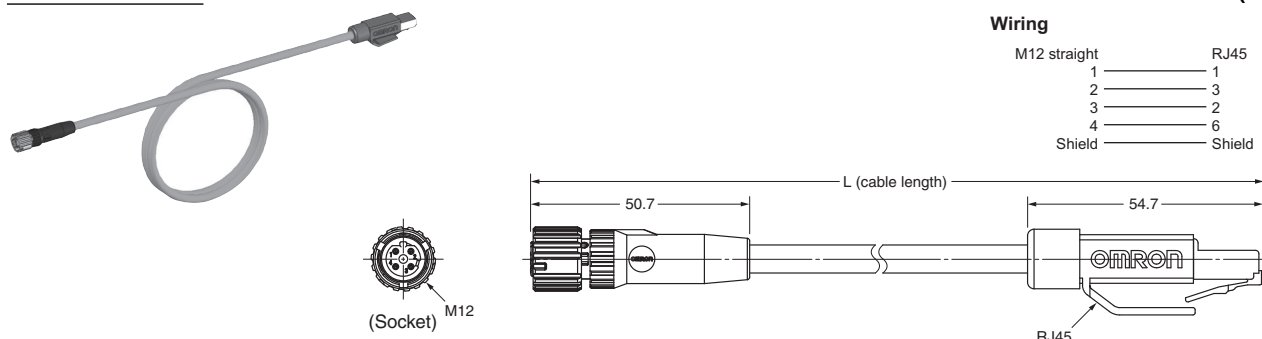

Ordering Information

Type	Cable length L (m)	Model
		Standard Cable
Cable with Connector on Both Ends (M12 straight socket/ RJ45 plug)	0.5	XS5W-T421-BME-K
	1	XS5W-T421-CME-K
	2	XS5W-T421-DME-K
	3	XS5W-T421-EME-K
	5	XS5W-T421-GME-K
	10	XS5W-T421-JME-K
	15	XS5W-T421-KME-K

Ask your OMRON representative about other specifications.

XS5W-T422-□M2-K (2 x M12, Right Angle Plugs)



Dimensions

(Unit: mm)

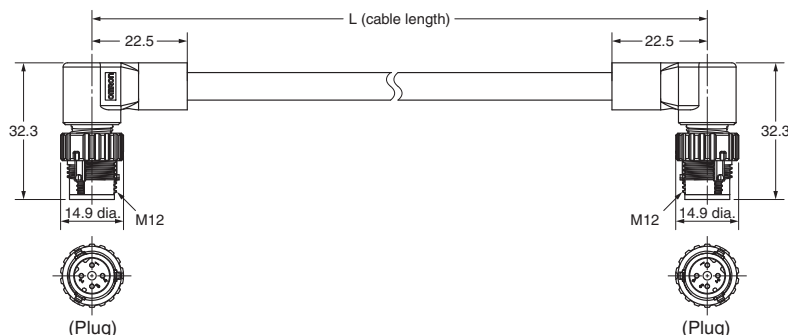

Wiring

M12 right angle	M12 right angle
1	1
2	2
3	3
4	4
Shield	Shield

Ordering Information

Type	Cable length L (m)	Model
		Standard Cable
Cable with Connector on Both Ends (M12 right angle plug / M12 right angle plug)	0.5	XS5W-T422-BM2-K
	1	XS5W-T422-CM2-K
	2	XS5W-T422-DM2-K
	3	XS5W-T422-EM2-K
	5	XS5W-T422-GM2-K
	10	XS5W-T422-JM2-K
	15	XS5W-T422-KM2-K

XS5W-T422-□MC-K (1x M12, Right Angle Plug and 1x Rugged RJ45 Plug)



Dimensions

(Unit: mm)

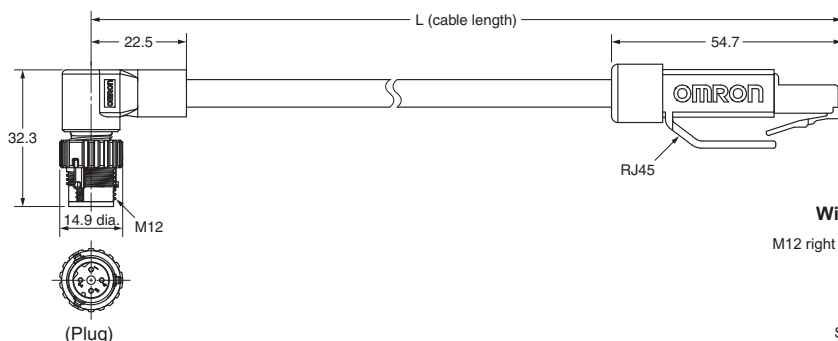

Wiring

M12 right angle	RJ45
1	1
2	3
3	2
4	6
Shield	Shield

Ordering Information

Type	Cable length L (m)	Model
		Standard Cable
Cable with Connector on Both Ends (M12 right angle plug / RJ45 plug)	0.3	XS5W-T422-AMC-K
	0.5	XS5W-T422-BMC-K
	1	XS5W-T422-CMC-K
	2	XS5W-T422-DMC-K
	3	XS5W-T422-EMC-K
	5	XS5W-T422-GMC-K
	10	XS5W-T422-JMC-K
	15	XS5W-T422-KMC-K

Note: Ask your OMRON representative about other specifications.

XS5W-T421-□MD-K(-KR) (2 x Rugged RJ45 Plugs)

Dimensions

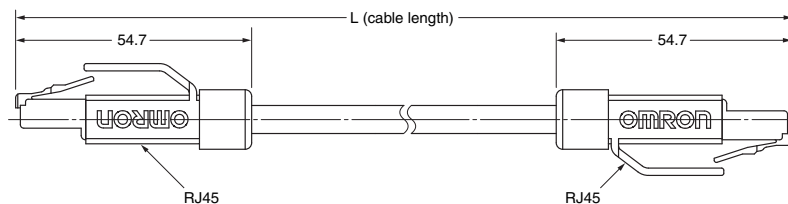
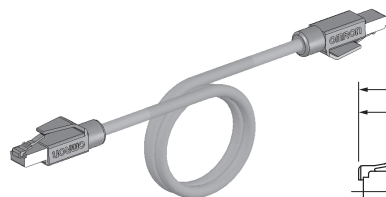

(Unit: mm)

Wiring

RJ45	RJ45
1	1
2	2
3	3
6	6
Shield	Shield

Ordering Information

Type	Cable length L (m)	Model	
		Standard Cable	Robot Cable
Cable with Connector on Both Ends (RJ45 plug / RJ45 plug)	0.3	XS5W-T421-AMD-K	- - -
	0.5	XS5W-T421-BMD-K	XS5W-T421-BMD-KR
	1	XS5W-T421-CMD-K	XS5W-T421-CMD-KR
	2	XS5W-T421-DMD-K	XS5W-T421-DMD-KR
	3	XS5W-T421-EMD-K	XS5W-T421-EMD-KR
	5	XS5W-T421-GMD-K	XS5W-T421-GMD-KR
	10	XS5W-T421-JMD-K	XS5W-T421-JMD-KR
	15	XS5W-T421-KMD-K	XS5W-T421-KMD-KR

Note: Ask your OMRON representative about other specifications.

Model Number Legend

Use this model number legend to identify products from their model number. When ordering, use a model number from the table in *Ordering Information*.

XS5W - T42□ - □M□ -K
 1 2 3 4 5 6 7 8 9

1. Type

W: Connector connected to cable, plugs on both cable ends

2. Signal type

T: Ethernet

3. Connector Poles

4: 4 poles

4. Contact Plating

2: 0.4-μm gold plating - M12 connectors
 1.4 μm gold plating - RJ45 connectors

5. Cable Connection Direction

1: Straight
 2: Right Angle

6. Cable Length

A: 0.3 m G: 5 m
 B: 0.5 m J: 10 m
 C: 1 m K: 15 m
 D: 2 m
 E: 3 m

7. Connections

M: Standard Wiring Connections (See Dimensional Drawings)

8. Connectors on One End/Both Ends

1: One M12 Straight Plug + One M12 Straight Socket
 2: Two M12 Plugs
 C: One M12 Plug + One RJ45 Plug
 D: Two RJ45 Plugs
 E: One M12 Straight Socket + One RJ45 Plug

9. Cable Specifications

K: UL CM PVC (double shielded) / Cat.5E
 KR: Robot Cable

Assembly Connector - Rugged RJ45

■ XS6G - Plugs

XS6G-T421-1



Dimensions

(Unit: mm)

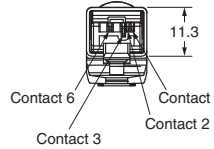
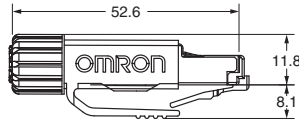

Applicable wires

Sheath outer diameter: 6.1 to 6.9 dia.
 Core Size: AWG22 to AWG24 (stranded wires)
 AWG22 to AWG23 (solid wires)
 Insulation outer diameter: 1.6 mm max.



Ordering Information

Type	Cable length L (m)	Model
		Straight
RJ45 Assembly Connector	- - -	XS6G-T421-1

4-Pin Panel-mount Connectors

■ XS5P - Sockets

XS5P-T42□-5 (Rear or Front locking M12 socket)



Dimensions

(Unit: mm)



XS5P-T426-5 (Rear Locking)

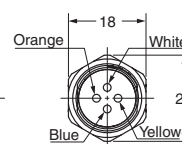
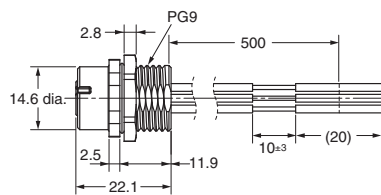
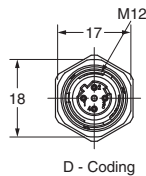

Wiring

Terminal No.	Color
1	Yellow
2	White
3	Orange
4	Blue

Panel Cutout Dimension

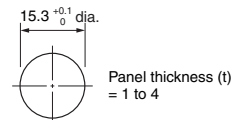

XS5P-T427-5 (Front Locking)

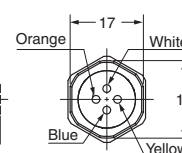
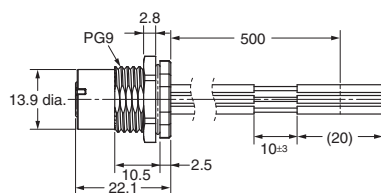
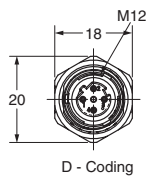

Note 1: The panel cutout dimension is the same for Front-locking and Rear-locking Connectors.

Note 2: Rotational positioning is not possible for connector rotation.

Ordering Information

Type		Cable length L (m)	Model
			Straight
M12 Connector for Panel Mounting	Rear Locking	0.5 m	XS5P-T426-5
	Front Locking	0.5 m	XS5P-T427-5

XS5P-T426-1 (PCB Straight Terminal, M12 socket)

Dimensions

(Unit: mm)

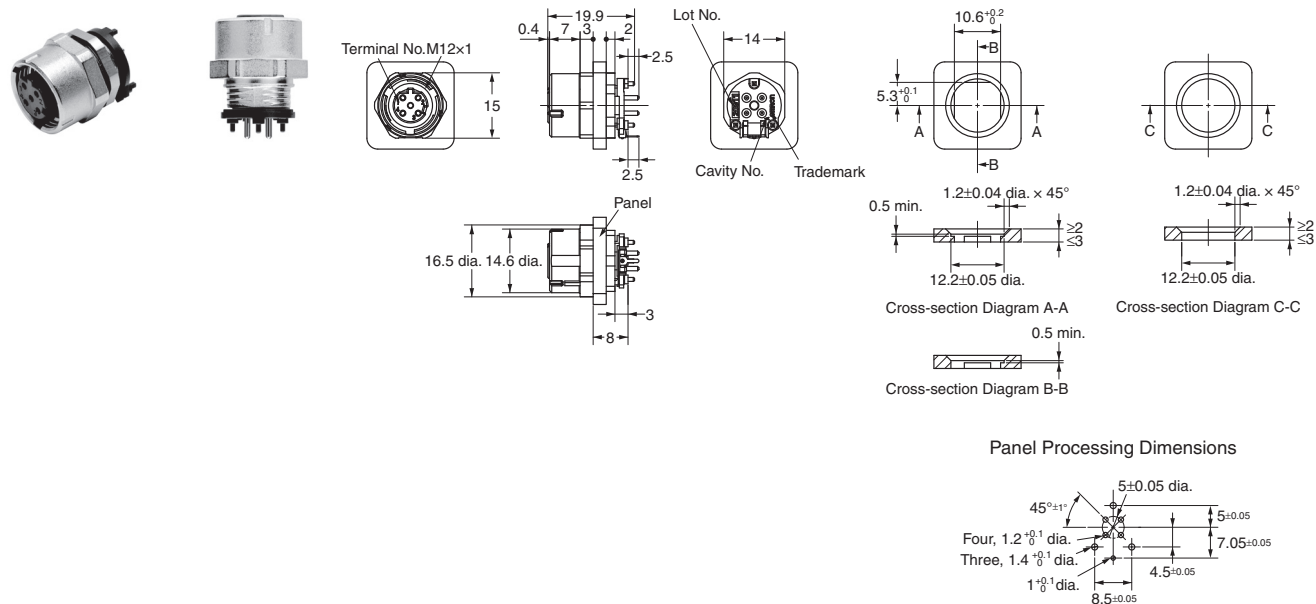

Ordering Information

Type		Cable length L (m)	Model
Rear Locking			Straight
M12 Panel Mounting, PCB Straight Terminals		---	XS5P-T426-1

Assembly Procedure

RJ45 Assembly Connectors XS6G-T421-1

1. Pass the cable through the cable clamp and the connector housing



2. Strip the cable sheath and ground braiding to the correct lengths.

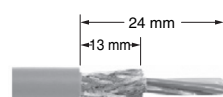

3. Follow the color codes and prepare to insert the wires into the splice piece.



4. Insert the wires into the splice piece for the length of the splice piece.



5. Place the splice piece into the RJ45 data module and engage it.



6. Place the data module and the splice piece on the IDC assembly housing.



7. Press the data module and the IDC assembly housing together and use pliers or a similar device to make the insulation displacement contact.



8. Remove the data module from the IDC assembly housing.



9. Place the upper screen plate on the data module and press it over the ground braiding of the cable.



10. Place the lower screen plate on the bottom of the data module, align it with the upper screen plate, and latch it until you hear it click into place.



11. Slide the housing that you placed around the cable in step 1 up to the data module and latch it until you hear it click into place.



12. Tighten the cable clamp.



Pin Assignments

Pin Assignments for Fast Ethernet 10/100 Mbps

Function/Signal	Wire color			Pin No.
	Industrial	EIA/TIA	EIA/TIA	
	Ethernet	568A	568B	
Transmission Data+/TD+	YE	WH/GN	WH/OG	1
Transmission Data-/TD-	OG	GN	OG	2
Receiver Data/RD+	WH	WH/OG	WH	3
Receiver Data/RD-	BU	OG	GN	6

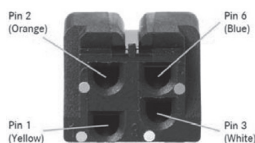

M12 Panel-mounting PCB Straight Terminals XS5P-T426-1

Confirming the Number of Parts

The following four parts are included in the package when it is delivered.

- Panel-mounting Parts
 1. Anchor
 2. O-Ring
 3. Nut
 4. Connector
- PCB-mounting Part
 4. Connector



Assembly Procedure

- Mount the connector to the PCB.
- Attach the anchor to the panel with the nut.

Mounting the Connector to the PCB Mounting the Anchor to the Panel

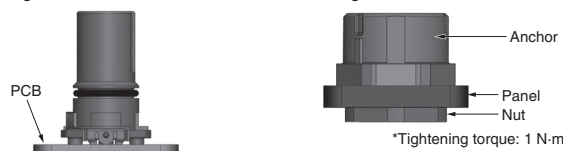

- Attach the connector that you mounted to the PCB to the panel.

* Make sure that the connector and anchor are oriented correctly.

Attachment

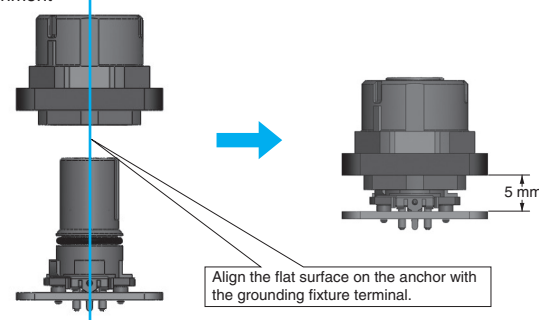

- Temporarily mount the O-ring to the top of the connector at the mating surface.

Temporary Mounting of the O-Ring

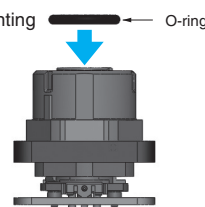

- Mate the Connector Waterproof Cover (XS2Z-22, sold separately) or the Partner Connector Plug (XS5H-T42□-□M0-K, sold separately) and press the O-ring to the O-ring position after mounting.

Mounting the O-Ring

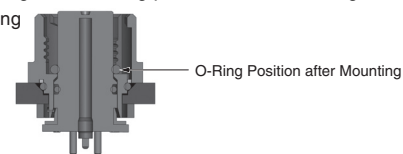

Connector Waterproof Cover (Sold Separately) XS2Z-22



* Tightening torque: 0.39 to 0.49 N·m

Precautions

■ Correct Use

Do not use the Connectors in an atmosphere or environment that exceeds the specifications.

Connector Connection and Disconnection

- When connecting or disconnecting Connectors, be sure to hold the Connectors by hand.
- Do not hold the cable when disconnecting Connectors.
- When mating Connectors, be sure to insert the plug all the way to the back of the socket before attempting to lock the Connectors.
- Do not use tools of any sort to mate the Connectors. Always use your hands. Pliers or other tools may damage the Connectors.

Wiring

- Lay the cables so that external force is not applied to the Connectors. Otherwise, the degree of protection (IP67) may not be achieved.

Degree of Protection for M12/SmartClick Connectors

- The degree of protection of Connectors (IP67) is not for a fully watertight structure. Do not use the Connectors underwater.
- Do not step on or place any objects on the Connectors. Doing so may damage the Connectors.

■ General Precautions

- Do not pull excessively on the Connectors or cables. Do not install the Connectors or cables in any way that would place a load directly on the mating section or cable connections. Doing so can damage the Connectors or break the wires inside the cables.
- Install the Connectors and cables where they will not be stepped on to prevent the wires inside the cables from being broken and to prevent the Connectors from being damaged. If the Connectors or cables must be installed where they might be stepped on, protect them with covers.
- Refer to the specifications for your cables before bending the cables and do not bend them past their minimum bending radius.

All sales are subject to Omron Electronic Components LLC standard terms and conditions of sale, which can be found at http://www.components.omron.com/components/web/webfiles.nsf/sales_terms.html

ALL DIMENSIONS SHOWN ARE IN MILLIMETERS.
To convert millimeters into inches, multiply by 0.03937. To convert grams into ounces, multiply by 0.03527.

OMRON[®]

**OMRON ELECTRONIC
COMPONENTS LLC**

55 E. Commerce Drive, Suite B
Schaumburg, IL 60173

847-882-2288

OMRON ON-LINE

Global - <http://www.omron.com>

USA - <http://www.components.omron.com>

Cat. No. G019-E-05

03/13 (01/14) Specifications subject to change without notice

Printed in USA