

# Selector Switches

## A22NS/A22NW

**22-mm Selector Switches**  
**Universal Design.**  
**Emphasis on Color Coding,**  
**Workability, and Safety.**

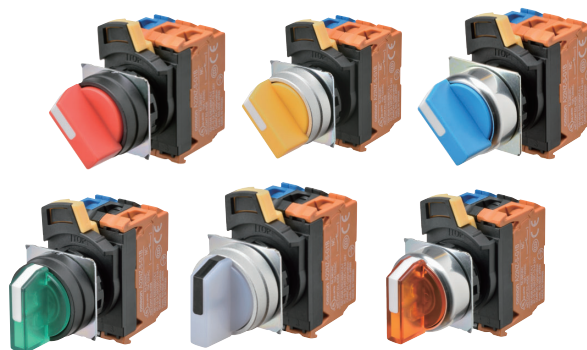

**Easy to Use**

- You can connect up to three Contact Blocks in one stage for multistage expansion.
- Screw terminal structure is compatible with round crimp terminals.

**Safety**

- Easy-to-operate lock lever for secure locking.
- Easy-mounting Contact Blocks provide finger protection.
- Different colors of Contact Blocks (NO: blue, NC: orange) help prevent wiring errors.

**Product Lineup**

- Meets global safety standards.
- Available in metal and plastic bezels.
- Many color variations.
- Standard-feature degree of protection: IP66, NEMA 4X, and NEMA 13.

Refer to *Safety Precautions for All Pushbutton Switches/Indicators* and *Safety Precautions in the A22NN/A22NL datasheet*

### Operation Unit Colors

		Red	Green	Yellow	White	Blue	Black		
Non-lighted Switches	A22NS-□□□-N□ Opaque								
		Red	Green	Yellow	White	Blue	Black		
Lighted Switches	A22NW-□□□-T□ Transparent	When not lit							
			Red	Green	Yellow	White	Blue	Orange	
		When lit							
			Red	Green	Yellow	White	Blue	Orange	Opaque white*

\* The colors when the Switches are lit are for transparent white Operation Units (code: TW) and yellow LED Lamps (code: Y).

# A22NS/A22NW

## List of Models

### Plastic Switches

Non-lighted

Two Positions



Three Positions



Lighted

Two Positions



Three Positions



### Brushed Metal Switches

Non-lighted

Two Positions



Three Positions



Lighted

Two Positions

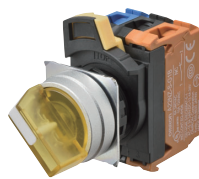

Three Positions



### Metal Switches

Non-lighted

Two Positions

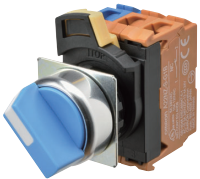

Three Positions

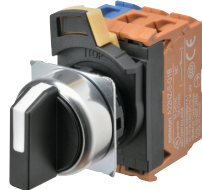

Lighted

Two Positions



Three Positions



## Model Number Structure

**Model Number Legend** - Shipped as a set that includes the Operation Unit, LED Lamp, Mounting Collar, and Contact Block.  
For information on combinations, refer to *Ordering Information* on pages 6 to 8.

### Model Numbers for Sets

A 2 2 N <sup>(1)</sup> W - <sup>(2)</sup> 2 B <sup>(3)</sup> M - <sup>(4)</sup> N R <sup>(5)</sup> A - <sup>(6)</sup> G <sup>(7)</sup> 1 0 1 - <sup>(8)</sup> R <sup>(9)</sup> A

#### (1) Type

Code	Type
S	Non-lighted
W	Lighted

#### (2) Number of Positions and Bezel Material

Code	No. of positions	Bezel material
2B	2	Plastic
2M	2	Brushed metal
2R	2	Metal
3B	3	Plastic
3M	3	Brushed metal
3R	3	Metal

#### (3) Reset Method

Code	Reset method		
M	Manual	Two-position manual	
		Three-position manual	
L	Automatic reset on left	Two-position automatic	
		Three-position left automatic	
R	Automatic reset on right	Three-position right automatic	
B	Automatic reset on left and right	Three-position left or right automatic	

#### (4) Operation Unit Transparency and Color and (8) LED Lamp Color

Lighted/non-lighted	Code (4)	Code (8)	Transparency	Operation Unit color	LED Lamp color
Non-lighted	NR	N	Opaque	Red	---
	NG		Opaque	Green	
	NY		Opaque	Yellow	
	NW		Opaque	White	
	NA		Opaque	Blue	
	NB		Opaque	Black	
Lighted	TR	R	Transparent	Red	Red
	TG	G	Transparent	Green	Green
	TY	Y	Transparent	Yellow	Yellow
	TW	W	Transparent	White	White
	TA	A	Transparent	Blue	Blue
	TO	O	Transparent	Orange	Orange
	TW	Y	Transparent	White*	Yellow

\* The color is opaque white when the Switch is lit.

#### (5) Degree of Protection

Code	Protection
A	IP66, NEMA 4X, NEMA13

#### (6) Contacts

Code	Description
G	General purpose

#### (7) Contact Configuration

Code	Contact Blocks		Non-lighted						Lighted				
			Unit position			No. of positions			Unit position			No. of positions	
	NO	NC	(1)	(2)	(3)	Two positions	Three positions	(1)	(2)	(3)	Two positions	Three positions	
100	1	0	NO	---	---	Yes		NO	Lighting Unit	---	Yes		
002	0	1	---	---	NC	Yes		---	Lighting Unit	NC	Yes		
101	2	0	NO	---	NO	Yes	Yes	NO	Lighting Unit	NO	Yes	Yes	
102	1	1	NO	---	NC	Yes	Yes	NO	Lighting Unit	NC	Yes	Yes	
201	1	1	NC	---	NO		Yes	NC	Lighting Unit	NO		Yes	
202	0	2	NC	---	NC	Yes	Yes	NC	Lighting Unit	NC	Yes	Yes	
110	2	0	NO	NO	---		Yes						
111	3	0	NO	NO	NO	Yes	Yes						
112	2	1	NO	NO	NC	Yes	Yes						
210	1	1	NC	NO	---		Yes						
211	2	1	NC	NO	NO		Yes						
212	1	2	NC	NO	NC		Yes						
011	2	0	---	NO	NO		Yes						
012	1	1	---	NO	NC		Yes						
120	1	1	NO	NC	---		Yes						
121	2	1	NO	NC	NO		Yes						
122	1	2	NO	NC	NC	Yes	Yes						
220	0	2	NC	NC	---		Yes						
221	1	2	NC	NC	NO		Yes						
222	0	3	NC	NC	NC	Yes	Yes						
021	1	1	---	NC	NO		Yes						
022	0	2	---	NC	NC		Yes						

**Note:** 1. NO (blue): Normally open, NC (orange): Normally closed.  
2. Refer to the following figure for the Unit positions.



#### (9) LED Lamp Voltage

Code	LED Lamp voltage
N	Non-lighted
A	6 VAC/DC
B	12 VAC/DC
C	24 VAC/DC
D	100/110/120 VAC
E	200/220/230/240 VAC

■ Specifications: Refer to page 13 and refer to the A22NN/A22NL. ■ Precautions for correct use: Refer to the A22NN/A22NL.  
■ Dimensions: Refer to page 14.

# A22NS/A22NW

## Structure

### Contact Configuration Table

#### Two Positions

No. of outputs	Code	Contact configuration	Unit position	Contacts	Position	
					1	2
1	100	SPST-NO	(1)	NO		ON
			(2)	---	---	---
			(3)	---	---	---
1	002	SPST-NC	(1)	---	---	---
			(2)	---	---	---
			(3)	NC	ON	
2	102	SPST-NO/ SPST-NC	(1)	NO		ON
			(2)	---	---	---
			(3)	NC	ON	
2	101	DPST-NO	(1)	NO		ON
			(2)	---	---	---
			(3)	NO		ON
2	202	DPST-NC	(1)	NC	ON	
			(2)	---	---	---
			(3)	NC	ON	
3	111	3PST-NO	(1)	NO		ON
			(2)	NO		ON
			(3)	NO		ON
3	222	3PST-NC	(1)	NC	ON	
			(2)	NC	ON	
			(3)	NC	ON	
3	122	SPST-NO/ DPST-NC	(1)	NO		ON
			(2)	NC	ON	
			(3)	NC	ON	
3	112	DPST-NO/ SPST-NC	(1)	NO		ON
			(2)	NO		ON
			(3)	NC	ON	

### Operation Angle

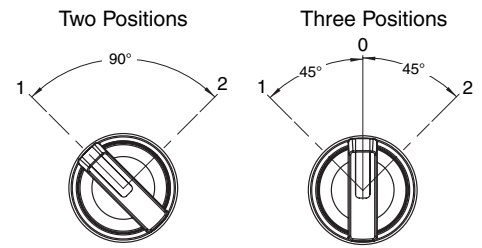

#### Three Positions

No. of outputs	Code	Contact configuration	Unit position	Contacts	Position		
					1	0	2
2	110	DPST-NO	(1)	NO	ON		
			(2)	NO	ON		ON
			(3)	---	---	---	---
2	011	DPST-NO	(1)	---	---	---	---
			(2)	NO	ON		ON
			(3)	NO			ON
2	101	DPST-NO	(1)	NO	ON		
			(2)	---	---	---	---
			(3)	NO			ON
2	220	DPST-NC	(1)	NC		ON	ON
			(2)	NC		ON	
			(3)	---	---	---	---
2	022	DPST-NC	(1)	---	---	---	---
			(2)	NC		ON	
			(3)	NC	ON	ON	
2	202	DPST-NC	(1)	NC		ON	ON
			(2)	---	---	---	---
			(3)	NC	ON	ON	

No. of outputs	Code	Contact configuration	Unit position	Contacts	Position		
					1	0	2
2	120	SPST-NO/ SPST-NC	(1)	NO	ON		
			(2)	NC		ON	
			(3)	---	---	---	---
2	102	SPST-NO/ SPST-NC	(1)	NO	ON		
			(2)	---	---	---	---
			(3)	NC	ON	ON	
2	210	SPST-NO/ SPST-NC	(1)	NC		ON	ON
			(2)	NO	ON		ON
			(3)	---	---	---	---
2	201	SPST-NO/ SPST-NC	(1)	NC		ON	ON
			(2)	---	---	---	---
			(3)	NO			ON
2	012	SPST-NO/ SPST-NC	(1)	---	---	---	---
			(2)	NO	ON		ON
			(3)	NC	ON	ON	
2	021	SPST-NO/ SPST-NC	(1)	---	---	---	---
			(2)	NC		ON	
			(3)	NO			ON
3	111	3PST-NO	(1)	NO	ON		
			(2)	NO	ON		ON
			(3)	NO			ON
3	222	3PST-NC	(1)	NC		ON	ON
			(2)	NC		ON	
			(3)	NC	ON	ON	
3	122	SPST-NO/ DPST-NC	(1)	NO	ON		
			(2)	NC		ON	
			(3)	NC	ON	ON	
3	212	SPST-NO/ DPST-NC	(1)	NC		ON	ON
			(2)	NO	ON		ON
			(3)	NC	ON	ON	
3	221	SPST-NO/ DPST-NC	(1)	NC		ON	ON
			(2)	NC		ON	
			(3)	NO	ON		ON
3	211	DPST-NO/ SPST-NC	(1)	NC		ON	ON
			(2)	NO	ON		ON
			(3)	NO			ON
3	121	DPST-NO/ SPST-NC	(1)	NO	ON		
			(2)	NC		ON	
			(3)	NO			ON
3	112	DPST-NO/ SPST-NC	(1)	NO	ON		
			(2)	NO	ON		ON
			(3)	NC	ON	ON	

Operation Angle

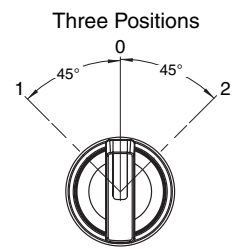



# A22NS/A22NW

## Ordering Information

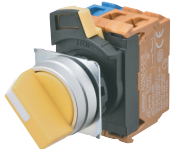
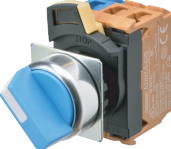
**Model Numbers for Sets** - - - Shipped as a set that includes the Operation Unit, LED Lamp, Mounting Collar, and Contact Block.  
**Non-lighted, Two-position, Selector Switches**

Appearance	Bezel material	No. of outputs	Model	(3) Reset method	(4)(4) Operation Unit color	(7)(7)(7) Contact configuration				
Plastic bezels 	2B	1	A22NS-2B(3)-(4)(4)A-G(7)(7)-NN	M: Manual L: Automatic reset on left	NR: Opaque red NG: Opaque green NY: Opaque yellow NW: Opaque white NA: Opaque blue NB: Opaque black	100 002				
		2				102 101 202				
		3				111 222 122 112				
Brushed metal bezels 	2M	1	A22NS-2M(3)-(4)(4)A-G(7)(7)-NN			M: Manual L: Automatic reset on left	NR: Opaque red NG: Opaque green NY: Opaque yellow NW: Opaque white NA: Opaque blue NB: Opaque black	100 002		
		2						102 101 202		
		3						111 222 122 112		
Metal bezels 	2R	1	A22NS-2R(3)-(4)(4)A-G(7)(7)-NN					M: Manual L: Automatic reset on left	NR: Opaque red NG: Opaque green NY: Opaque yellow NW: Opaque white NA: Opaque blue NB: Opaque black	100 002
		2								102 101 202
		3								111 222 122 112



Non-lighted, Three-position, Selector Switches

Appearance	Bezel material	No. of outputs	Model	(3) Reset method	(4)(4) Operation Unit color	(7)(7)(7) Contact configuration				
Plastic bezels 	3B	2	A22NS-3B(3)-(4)(4)A-G(7)(7)(7)-NN			110 011 101 220 022 202 120 102 210 201 012 021				
		3				111 222 122 212 221 211 121 112				
Brushed metal bezels 	3M	2	A22NS-3M(3)-(4)(4)A-G(7)(7)(7)-NN			M: Manual L: Automatic reset on left R: Automatic reset on right B: Automatic reset on left and right	NR: Opaque red NG: Opaque green NY: Opaque yellow NW: Opaque white NA: Opaque blue NB: Opaque black	110 011 101 220 022 202 120 102 210 201 012 021		
		3						111 222 122 212 221 211 121 112		
Metal bezels 	3R	2	A22NS-3R(3)-(4)(4)A-G(7)(7)(7)-NN							110 011 101 220 022 202 120 102 210 201 012 021
		3								111 222 122 212 221 211 121 112



# A22NS/A22NW

## Ordering Information

**Model Numbers for Sets** - - - Shipped as a set that includes the Operation Unit, LED Lamp, Mounting Collar, and Contact Block.  
**Lighted, Two-position, Selector Switches**

Appearance	Bezel material	No. of outputs	Model	(3) Reset method	(4)(4) Operation Unit color	(7)(7)(7) Contact Configuration	(8) LED Lamp color	(9) LED Lamp voltage										
Plastic bezels 	2B	1	A22NW-2B(3)-(4)(4)A-G(7)(7)(7)-(8)(9)	M: Manual L: Auto- matic reset on left		100 002	R: Red G: Green Y: Yellow A: Blue O: Orange	A: 6 VAC/DC B: 12 VAC/DC C: 24 VAC/DC D: 100/110/120 VAC E: 200/220/230/240 VAC										
		2							102 101 202									
Brushed metal bezels 	2M	1	A22NW-2M(3)-(4)(4)A-G(7)(7)(7)-(8)(9)						M: Manual L: Auto- matic reset on left		100 002	R: Red G: Green Y: Yellow A: Blue O: Orange	A: 6 VAC/DC B: 12 VAC/DC C: 24 VAC/DC D: 100/110/120 VAC E: 200/220/230/240 VAC					
		2												102 101 202				
Metal bezels 	2R	1	A22NW-2R(3)-(4)(4)A-G(7)(7)(7)-(8)(9)											M: Manual L: Auto- matic reset on left		100 002	R: Red G: Green Y: Yellow A: Blue O: Orange	A: 6 VAC/DC B: 12 VAC/DC C: 24 VAC/DC D: 100/110/120 VAC E: 200/220/230/240 VAC
		2																

## Lighted, Three-position, Selector Switches

Appearance	Bezel material	No. of outputs	Model	(3) Reset method	(4)(4) Operation Unit color	(7)(7)(7) Contact Configuration	(8) LED Lamp color	(9) LED Lamp voltage										
Plastic bezels 	3B	2	A22NW-3B(3)-(4)(4)A-G(7)(7)(7)-(8)(9)	M: Manual L: Automatic reset on left R: Automatic reset on right B: Automatic reset on left and right		101 202 102 201	R: Red G: Green Y: Yellow A: Blue O: Orange	A: 6 VAC/DC B: 12 VAC/DC C: 24 VAC/DC D: 100/110/120 VAC E: 200/220/230/240 VAC										
									Brushed metal bezels 	3M	2	A22NW-3M(3)-(4)(4)A-G(7)(7)(7)-(8)(9)	M: Manual L: Automatic reset on left R: Automatic reset on right B: Automatic reset on left and right		101 202 102 201	R: Red G: Green Y: Yellow A: Blue O: Orange	A: 6 VAC/DC B: 12 VAC/DC C: 24 VAC/DC D: 100/110/120 VAC E: 200/220/230/240 VAC	
Metal bezels 	3R	2	A22NW-3R(3)-(4)(4)A-G(7)(7)(7)-(8)(9)															M: Manual L: Automatic reset on left R: Automatic reset on right B: Automatic reset on left and right

**Note:** Normally, the Operation Unit and LED Lamp with the same color are combined.  
 However, opaque white is available by combining a white Operation Unit and yellow LED. A22N□-□□□-TWA-G□□□-Y□

■ Subassemblies: Refer to pages 9 to 12.  
 (You can order Operation Units, LED Lamps, Mounting Collars, and Contact Blocks individually.)

■ Specifications: Refer to page 10 and refer to the A22NN/A22NL.  
 ■ Dimensions: Refer to page 14.  
 ■ Accessories and tools: Refer to the A22NN/A22NL.



## Ordering Information

**Subassemblies** - - - - You can order Operation Units, LED Lamps, Mounting Collars, and Contact Blocks individually. Use them in combination for models that are not available as assembled Switches. They can also be used as inventory for maintenance parts.

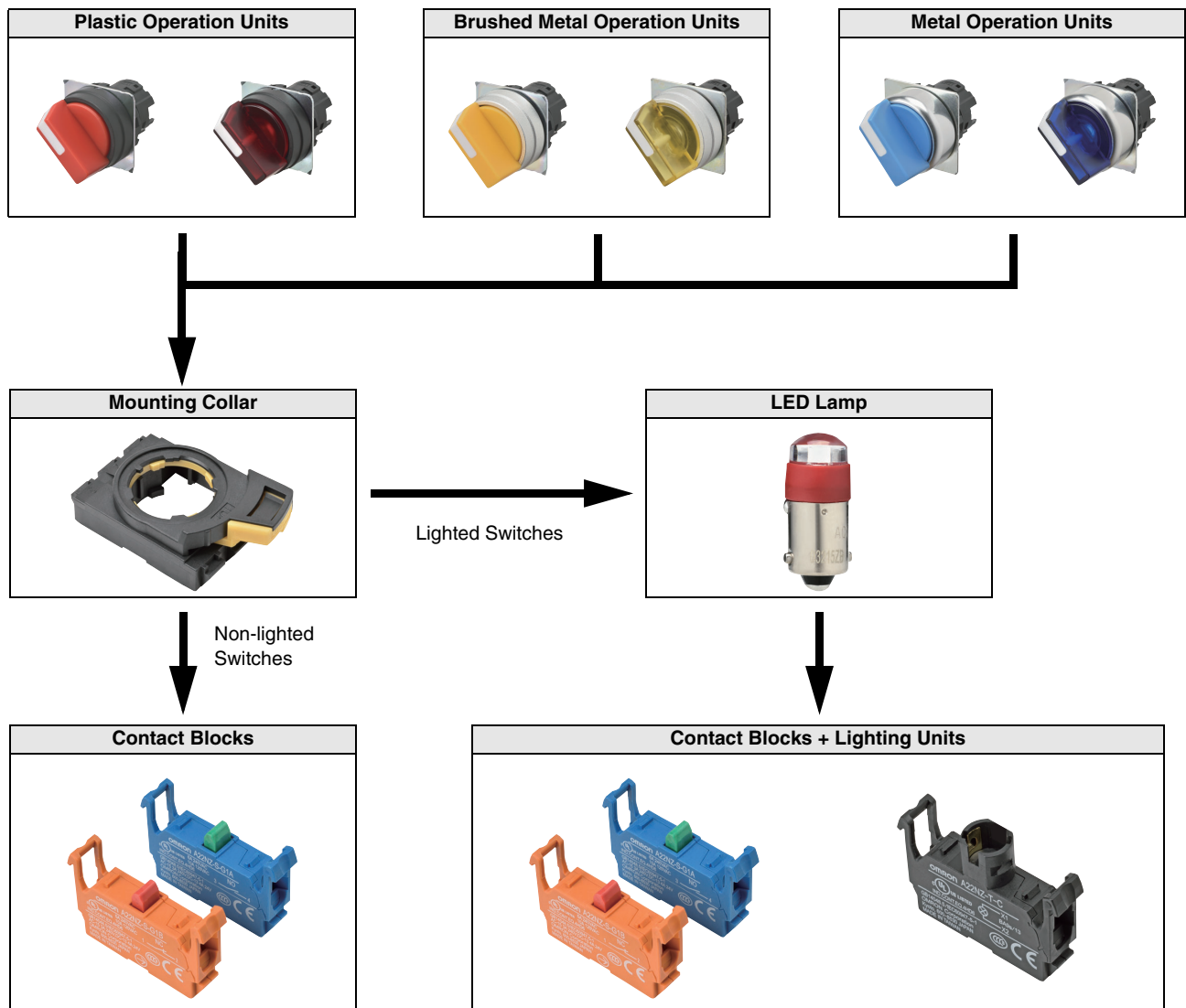

**Note:** Use a Reinforcement Plate for greater strength.

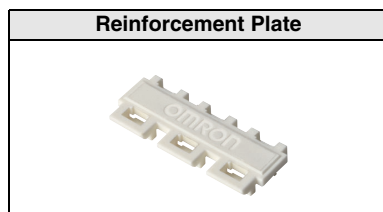

■ Model numbers of sets: Refer to pages 6 to 8.

■ Specifications: Refer to page 10 and refer to the A22NN/A22NL.  
 ■ Dimensions: Refer to page 14.  
 ■ Accessories and tools: Refer to the A22NN/A22NL.

# A22NS/A22NW

## Ordering Information

**Subassemblies** ----- You can order Operation Units, LED Lamps, Mounting Collars, and Contact Blocks individually. Use them in combination for models that are not available as assembled Switches. They can also be used as inventory for maintenance parts.

### Operation Unit Non-lighted Switches

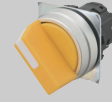
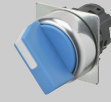
Bezel material and shape			Plastic	Brushed metal	Metal
					
No. of positions	Reset method	Operation Unit color	Model	Model	Model
2	Manual	Opaque red	A22NZ-2BM-NRA	A22NZ-2MM-NRA	A22NZ-2RM-NRA
	Automatic reset on left		A22NZ-2BL-NRA	A22NZ-2ML-NRA	A22NZ-2RL-NRA
3	Manual		A22NZ-3BM-NRA	A22NZ-3MM-NRA	A22NZ-3RM-NRA
	Automatic reset on left		A22NZ-3BL-NRA	A22NZ-3ML-NRA	A22NZ-3RL-NRA
	Automatic reset on right		A22NZ-3BR-NRA	A22NZ-3MR-NRA	A22NZ-3RR-NRA
	Automatic reset on left and right		A22NZ-3BB-NRA	A22NZ-3MB-NRA	A22NZ-3RB-NRA
2	Manual		A22NZ-2BM-NGA	A22NZ-2MM-NGA	A22NZ-2RM-NGA
	Automatic reset on left		A22NZ-2BL-NGA	A22NZ-2ML-NGA	A22NZ-2RL-NGA
3	Manual		A22NZ-3BM-NGA	A22NZ-3MM-NGA	A22NZ-3RM-NGA
	Automatic reset on left		A22NZ-3BL-NGA	A22NZ-3ML-NGA	A22NZ-3RL-NGA
	Automatic reset on right	A22NZ-3BR-NGA	A22NZ-3MR-NGA	A22NZ-3RR-NGA	
	Automatic reset on left and right	A22NZ-3BB-NGA	A22NZ-3MB-NGA	A22NZ-3RB-NGA	
2	Manual	A22NZ-2BM-NYA	A22NZ-2MM-NYA	A22NZ-2RM-NYA	
	Automatic reset on left	A22NZ-2BL-NYA	A22NZ-2ML-NYA	A22NZ-2RL-NYA	
3	Manual	A22NZ-3BM-NYA	A22NZ-3MM-NYA	A22NZ-3RM-NYA	
	Automatic reset on left	A22NZ-3BL-NYA	A22NZ-3ML-NYA	A22NZ-3RL-NYA	
	Automatic reset on right	A22NZ-3BR-NYA	A22NZ-3MR-NYA	A22NZ-3RR-NYA	
	Automatic reset on left and right	A22NZ-3BB-NYA	A22NZ-3MB-NYA	A22NZ-3RB-NYA	
2	Manual	A22NZ-2BM-NWA	A22NZ-2MM-NWA	A22NZ-2RM-NWA	
	Automatic reset on left	A22NZ-2BL-NWA	A22NZ-2ML-NWA	A22NZ-2RL-NWA	
3	Manual	A22NZ-3BM-NWA	A22NZ-3MM-NWA	A22NZ-3RM-NWA	
	Automatic reset on left	A22NZ-3BL-NWA	A22NZ-3ML-NWA	A22NZ-3RL-NWA	
	Automatic reset on right	A22NZ-3BR-NWA	A22NZ-3MR-NWA	A22NZ-3RR-NWA	
	Automatic reset on left and right	A22NZ-3BB-NWA	A22NZ-3MB-NWA	A22NZ-3RB-NWA	
2	Manual	A22NZ-2BM-NAA	A22NZ-2MM-NAA	A22NZ-2RM-NAA	
	Automatic reset on left	A22NZ-2BL-NAA	A22NZ-2ML-NAA	A22NZ-2RL-NAA	
3	Manual	A22NZ-3BM-NAA	A22NZ-3MM-NAA	A22NZ-3RM-NAA	
	Automatic reset on left	A22NZ-3BL-NAA	A22NZ-3ML-NAA	A22NZ-3RL-NAA	
	Automatic reset on right	A22NZ-3BR-NAA	A22NZ-3MR-NAA	A22NZ-3RR-NAA	
	Automatic reset on left and right	A22NZ-3BB-NAA	A22NZ-3MB-NAA	A22NZ-3RB-NAA	
2	Manual	A22NZ-2BM-NBA	A22NZ-2MM-NBA	A22NZ-2RM-NBA	
	Automatic reset on left	A22NZ-2BL-NBA	A22NZ-2ML-NBA	A22NZ-2RL-NBA	
3	Manual	A22NZ-3BM-NBA	A22NZ-3MM-NBA	A22NZ-3RM-NBA	
	Automatic reset on left	A22NZ-3BL-NBA	A22NZ-3ML-NBA	A22NZ-3RL-NBA	
	Automatic reset on right	A22NZ-3BR-NBA	A22NZ-3MR-NBA	A22NZ-3RR-NBA	
	Automatic reset on left and right	A22NZ-3BB-NBA	A22NZ-3MB-NBA	A22NZ-3RB-NBA	

■ Model numbers of sets: Refer to pages 6 to 8.

■ Specifications: Refer to page 10 and refer to the A22NN/A22NL.

■ Dimensions: Refer to page 14.

■ Accessories and tools: Refer to the A22NN/A22NL.

## Ordering Information

**Subassemblies** - - - - You can order Operation Units, LED Lamps, Mounting Collars, and Contact Blocks individually. Use them in combination for models that are not available as assembled Switches. They can also be used as inventory for maintenance parts.

### Lighted Switches

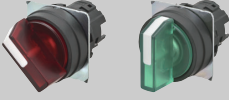
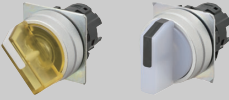
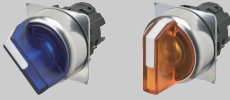
Bezel material and shape			Plastic	Brushed metal	Metal	
No. of positions	Reset method	Operation Unit color				
			Model	Model	Model	
2	Manual	Transparent red	A22NZ-2BM-TRA	A22NZ-2MM-TRA	A22NZ-2RM-TRA	
	Automatic reset on left		A22NZ-2BL-TRA	A22NZ-2ML-TRA	A22NZ-2RL-TRA	
3	Manual		A22NZ-3BM-TRA	A22NZ-3MM-TRA	A22NZ-3RM-TRA	
	Automatic reset on left		A22NZ-3BL-TRA	A22NZ-3ML-TRA	A22NZ-3RL-TRA	
	Automatic reset on right		A22NZ-3BR-TRA	A22NZ-3MR-TRA	A22NZ-3RR-TRA	
	Automatic reset on left and right		A22NZ-3BB-TRA	A22NZ-3MB-TRA	A22NZ-3RB-TRA	
2	Manual		Transparent green	A22NZ-2BM-TGA	A22NZ-2MM-TGA	A22NZ-2RM-TGA
	Automatic reset on left			A22NZ-2BL-TGA	A22NZ-2ML-TGA	A22NZ-2RL-TGA
3	Manual			A22NZ-3BM-TGA	A22NZ-3MM-TGA	A22NZ-3RM-TGA
	Automatic reset on left			A22NZ-3BL-TGA	A22NZ-3ML-TGA	A22NZ-3RL-TGA
	Automatic reset on right	A22NZ-3BR-TGA		A22NZ-3MR-TGA	A22NZ-3RR-TGA	
	Automatic reset on left and right	A22NZ-3BB-TGA		A22NZ-3MB-TGA	A22NZ-3RB-TGA	
2	Manual	Transparent yellow		A22NZ-2BM-TYA	A22NZ-2MM-TYA	A22NZ-2RM-TYA
	Automatic reset on left			A22NZ-2BL-TYA	A22NZ-2ML-TYA	A22NZ-2RL-TYA
3	Manual			A22NZ-3BM-TYA	A22NZ-3MM-TYA	A22NZ-3RM-TYA
	Automatic reset on left			A22NZ-3BL-TYA	A22NZ-3ML-TYA	A22NZ-3RL-TYA
	Automatic reset on right		A22NZ-3BR-TYA	A22NZ-3MR-TYA	A22NZ-3RR-TYA	
	Automatic reset on left and right		A22NZ-3BB-TYA	A22NZ-3MB-TYA	A22NZ-3RB-TYA	
2	Manual		Transparent white	A22NZ-2BM-TWA	A22NZ-2MM-TWA	A22NZ-2RM-TWA
	Automatic reset on left			A22NZ-2BL-TWA	A22NZ-2ML-TWA	A22NZ-2RL-TWA
3	Manual			A22NZ-3BM-TWA	A22NZ-3MM-TWA	A22NZ-3RM-TWA
	Automatic reset on left			A22NZ-3BL-TWA	A22NZ-3ML-TWA	A22NZ-3RL-TWA
	Automatic reset on right	A22NZ-3BR-TWA		A22NZ-3MR-TWA	A22NZ-3RR-TWA	
	Automatic reset on left and right	A22NZ-3BB-TWA		A22NZ-3MB-TWA	A22NZ-3RB-TWA	
2	Manual	Transparent blue		A22NZ-2BM-TAA	A22NZ-2MM-TAA	A22NZ-2RM-TAA
	Automatic reset on left			A22NZ-2BL-TAA	A22NZ-2ML-TAA	A22NZ-2RL-TAA
3	Manual			A22NZ-3BM-TAA	A22NZ-3MM-TAA	A22NZ-3RM-TAA
	Automatic reset on left			A22NZ-3BL-TAA	A22NZ-3ML-TAA	A22NZ-3RL-TAA
	Automatic reset on right		A22NZ-3BR-TAA	A22NZ-3MR-TAA	A22NZ-3RR-TAA	
	Automatic reset on left and right		A22NZ-3BB-TAA	A22NZ-3MB-TAA	A22NZ-3RB-TAA	
2	Manual		Transparent orange	A22NZ-2BM-TOA	A22NZ-2MM-TOA	A22NZ-2RM-TOA
	Automatic reset on left			A22NZ-2BL-TOA	A22NZ-2ML-TOA	A22NZ-2RL-TOA
3	Manual			A22NZ-3BM-TOA	A22NZ-3MM-TOA	A22NZ-3RM-TOA
	Automatic reset on left			A22NZ-3BL-TOA	A22NZ-3ML-TOA	A22NZ-3RL-TOA
	Automatic reset on right	A22NZ-3BR-TOA		A22NZ-3MR-TOA	A22NZ-3RR-TOA	
	Automatic reset on left and right	A22NZ-3BB-TOA		A22NZ-3MB-TOA	A22NZ-3RB-TOA	

■ Model numbers of sets: Refer to pages 6 to 8.

■ Specifications: Refer to page 10 and refer to the A22NN/A22NL.  
 ■ Dimensions: Refer to page 14.  
 ■ Accessories and tools: Refer to the A22NN/A22NL.

# A22NS/A22NW

## Ordering Information

**Subassemblies** - - - You can order Operation Units, LED Lamps, Mounting Collars, and Contact Blocks individually. Use them in combination for models that are not available as assembled Switches. They can also be used as inventory for maintenance parts.

### LED Lamps

Appearance	Applied voltage	6 VAC/DC	12 VAC/DC	24 VAC/DC	100/110/120 VAC	200/220/230/240 VAC
	Color	Model	Model	Model	Model	Model
	Red	A22NZ-L-RA	A22NZ-L-RB	A22NZ-L-RC	A22NZ-L-RD	A22NZ-L-RE
	Green	A22NZ-L-GA	A22NZ-L-GB	A22NZ-L-GC	A22NZ-L-GD	A22NZ-L-GE
	Yellow	A22NZ-L-YA	A22NZ-L-YB	A22NZ-L-YC	A22NZ-L-YD	A22NZ-L-YE
	White	A22NZ-L-WA	A22NZ-L-WB	A22NZ-L-WC	A22NZ-L-WD	A22NZ-L-WE
	Blue	A22NZ-L-AA	A22NZ-L-AB	A22NZ-L-AC	A22NZ-L-AD	A22NZ-L-AE
	Orange	A22NZ-L-OA	A22NZ-L-OB	A22NZ-L-OC	A22NZ-L-OD	A22NZ-L-OE

### Mounting Collar

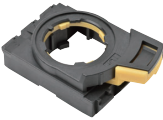
Appearance	Model
	A22NZ-H-01

### Contact Blocks

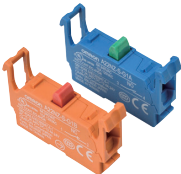
Appearance	Contacts	Model
	SPST-NO (blue)	A22NZ-S-G1A
	SPST-NC (orange)	A22NZ-S-G1B

### Lighting Units

Appearance	Applied voltage	Model
	6 VAC/DC	A22NZ-T-A
	12 VAC/DC	A22NZ-T-B
	24 VAC/DC	A22NZ-T-C
	100/110/120 VAC	A22NZ-T-D
	200/220/230/240 VAC	A22NZ-T-E

### Reinforcement Plate

Appearance	Model
	A22NZ-A-C01

■ Model numbers of sets: Refer to pages 6 to 8.

■ Specifications: Refer to page 10 and refer to the A22NN/A22NL.

■ Dimensions: Refer to page 14.

■ Accessories and tools: Refer to the A22NN/A22NL.

## Specifications

### Characteristics

Item	Type	Selector Switches	
		Non-lighted models	Lighted models
Allowable operating frequency	Mechanical	30 operations/minute max.	
	Electrical	30 operations/minute max.	
Insulation resistance		100 MΩ min. (at 500 VDC)	
Contact resistance		100 mΩ max. (initial value)	
Dielectric strength	Between terminals of same polarity	2,500 VAC at 50/60 Hz for 1 min	
	Between each terminal and ground	2,500 VAC at 50/60 Hz for 1 min	
Vibration resistance	Malfunction	10 to 55 Hz, 1.5-mm double amplitude (malfunction within 1 ms)	
Shock resistance	Malfunction	1,000 m/s <sup>2</sup> max. (malfunction within 1 ms)	
Durability	Mechanical	500,000 operations min. (Switches with 3 positions: 300,000 operations min.)	
	Electrical	500,000 operations min. (Switches with 3 positions: 300,000 operations min.)	
Ambient operating temperature <sup>*1</sup>		-25 to 70°C	-25 to 55°C
Ambient operating humidity		35% to 85% RH	
Ambient storage temperature <sup>*1</sup>		-40 to 80°C	
Degree of protection <sup>*2</sup>		IP66, NEMA 4X, NEMA 13	
Electric shock protection class		Class II	
PTI (tracking characteristic)		175	
Degree of contamination (application environment)		3 (IEC 60947-5-1)	
Weight		Approx. 50 g (for 1NC/1NO)	Approx. 60 g (for 1NC/1NO)

\*1. With no icing or condensation.

\*2. Degree of protection from the front of the panel.

### Operating Characteristics (for SPST-NO/SPST-NC)

Item	Type	Selector Switches	
		Manual reset	Automatic reset
Total travel force (torque) (maximum TTF)		0.6 N·m	0.6 N·m
Total travel (TT)		2 positions: Approx. 90°, 3 positions: Approx. 45°	
Resetting force (torque) (RF)		0.5 N·m max.	---

### Examples of Linked Contact Blocks



Contact Blocks



Lighting Units

	Selector Switches			
	2 positions		3 positions	
	Lighted	Non-lighted	Lighted	Non-lighted
Linking example				

\* If you use three Contact Blocks in stage 1, you can add one more Contact Block in the middle of stage 2.

**Note:** If you increase the number of Contact Blocks, evaluate the Switch under actual working conditions before permanent installation and use the Switch within a number of switching operations that will not adversely affect the Switch's performance.

# A22NS/A22NW

## Dimensions

(Unit: mm)

### Lighted and Non-lighted Selection Switches

#### Two-position Switches with Plastic Bezels

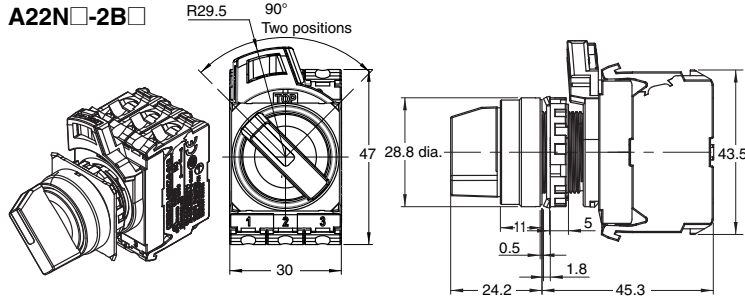

#### Three-position Switches with Plastic Bezels

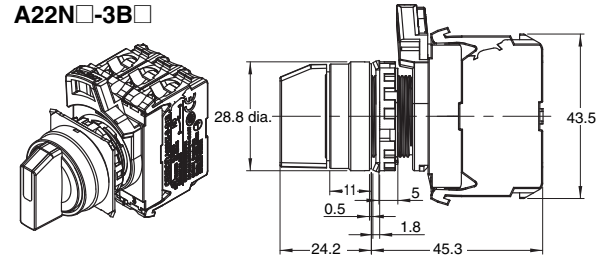

#### Two-position Switches with Brushed Metal Bezels

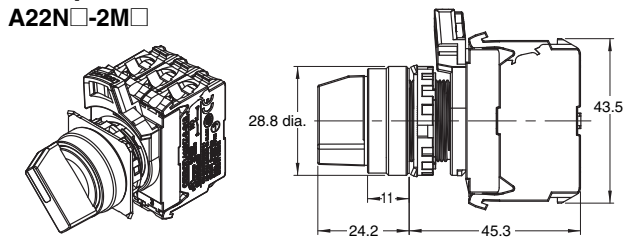

#### Three-position Switches with Brushed Metal Bezels

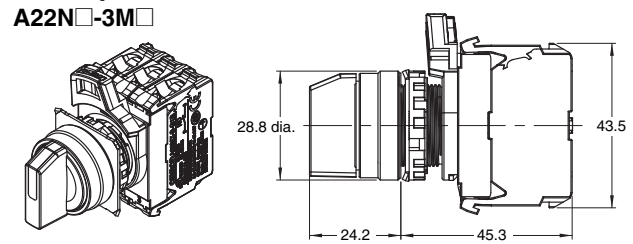

#### Two-position Switches with Metal Bezels

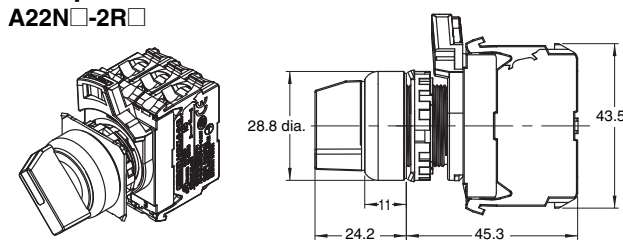

#### Three-position Switches with Metal Bezels

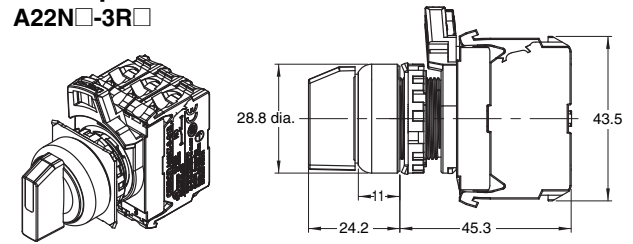

### Depth with Linked Units

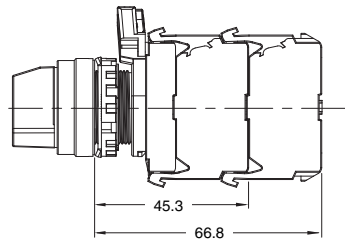

### Terminal Wiring Diagrams

#### Bottom View

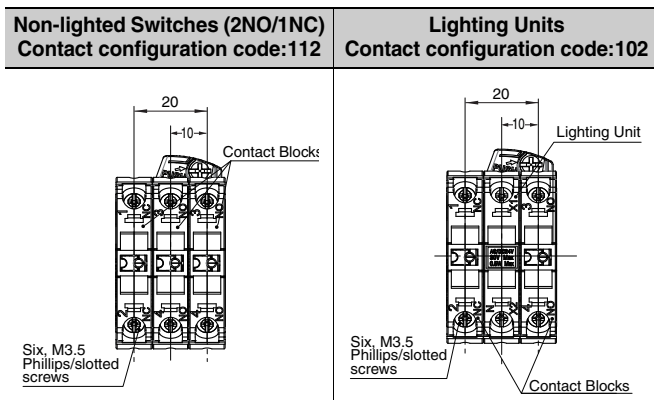

### Terminal Connection Diagrams

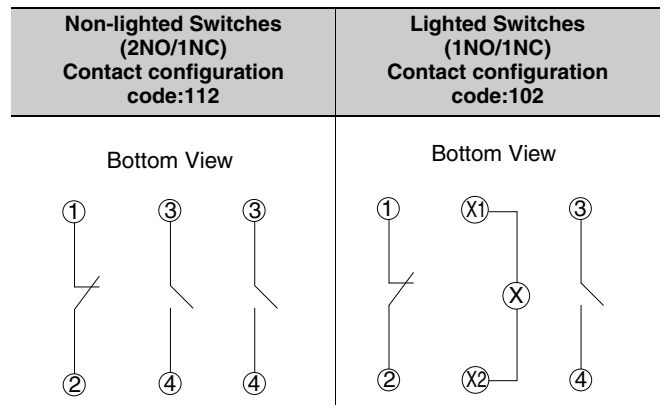

### Safety Precautions

Refer to *Safety Precautions for All Pushbutton Switches/Indicators* for common precautions. Read the *Safety Precautions* in the A22NN/A22NL datasheet.

# Terms and Conditions Agreement

## **Read and understand this catalog.**

Please read and understand this catalog before purchasing the products. Please consult your OMRON representative if you have any questions or comments.

## **Warranties.**

(a) Exclusive Warranty. Omron's exclusive warranty is that the Products will be free from defects in materials and workmanship for a period of twelve months from the date of sale by Omron (or such other period expressed in writing by Omron). Omron disclaims all other warranties, express or implied.

(b) Limitations. OMRON MAKES NO WARRANTY OR REPRESENTATION, EXPRESS OR IMPLIED, ABOUT NON-INFRINGEMENT, MERCHANTABILITY OR FITNESS FOR A PARTICULAR PURPOSE OF THE PRODUCTS. BUYER ACKNOWLEDGES THAT IT ALONE HAS DETERMINED THAT THE PRODUCTS WILL SUITABLY MEET THE REQUIREMENTS OF THEIR INTENDED USE.

Omron further disclaims all warranties and responsibility of any type for claims or expenses based on infringement by the Products or otherwise of any intellectual property right. (c) Buyer Remedy. Omron's sole obligation hereunder shall be, at Omron's election, to (i) replace (in the form originally shipped with Buyer responsible for labor charges for removal or replacement thereof) the non-complying Product, (ii) repair the non-complying Product, or (iii) repay or credit Buyer an amount equal to the purchase price of the non-complying Product; provided that in no event shall Omron be responsible for warranty, repair, indemnity or any other claims or expenses regarding the Products unless Omron's analysis confirms that the Products were properly handled, stored, installed and maintained and not subject to contamination, abuse, misuse or inappropriate modification. Return of any Products by Buyer must be approved in writing by Omron before shipment. Omron Companies shall not be liable for the suitability or unsuitability or the results from the use of Products in combination with any electrical or electronic components, circuits, system assemblies or any other materials or substances or environments. Any advice, recommendations or information given orally or in writing, are not to be construed as an amendment or addition to the above warranty.

See <http://www.omron.com/global/> or contact your Omron representative for published information.

## **Limitation on Liability; Etc.**

OMRON COMPANIES SHALL NOT BE LIABLE FOR SPECIAL, INDIRECT, INCIDENTAL, OR CONSEQUENTIAL DAMAGES, LOSS OF PROFITS OR PRODUCTION OR COMMERCIAL LOSS IN ANY WAY CONNECTED WITH THE PRODUCTS, WHETHER SUCH CLAIM IS BASED IN CONTRACT, WARRANTY, NEGLIGENCE OR STRICT LIABILITY.

Further, in no event shall liability of Omron Companies exceed the individual price of the Product on which liability is asserted.

## **Suitability of Use.**

Omron Companies shall not be responsible for conformity with any standards, codes or regulations which apply to the combination of the Product in the Buyer's application or use of the Product. At Buyer's request, Omron will provide applicable third party certification documents identifying ratings and limitations of use which apply to the Product. This information by itself is not sufficient for a complete determination of the suitability of the Product in combination with the end product, machine, system, or other application or use. Buyer shall be solely responsible for determining appropriateness of the particular Product with respect to Buyer's application, product or system. Buyer shall take application responsibility in all cases.

NEVER USE THE PRODUCT FOR AN APPLICATION INVOLVING SERIOUS RISK TO LIFE OR PROPERTY OR IN LARGE QUANTITIES WITHOUT ENSURING THAT THE SYSTEM AS A WHOLE HAS BEEN DESIGNED TO ADDRESS THE RISKS, AND THAT THE OMRON PRODUCT(S) IS PROPERLY RATED AND INSTALLED FOR THE INTENDED USE WITHIN THE OVERALL EQUIPMENT OR SYSTEM.

## **Programmable Products.**

Omron Companies shall not be responsible for the user's programming of a programmable Product, or any consequence thereof.

## **Performance Data.**

Data presented in Omron Company websites, catalogs and other materials is provided as a guide for the user in determining suitability and does not constitute a warranty. It may represent the result of Omron's test conditions, and the user must correlate it to actual application requirements. Actual performance is subject to the Omron's Warranty and Limitations of Liability.

## **Change in Specifications.**

Product specifications and accessories may be changed at any time based on improvements and other reasons. It is our practice to change part numbers when published ratings or features are changed, or when significant construction changes are made. However, some specifications of the Product may be changed without any notice. When in doubt, special part numbers may be assigned to fix or establish key specifications for your application. Please consult with your Omron's representative at any time to confirm actual specifications of purchased Product.

## **Errors and Omissions.**

Information presented by Omron Companies has been checked and is believed to be accurate; however, no responsibility is assumed for clerical, typographical or proofreading errors or omissions.



**OMRON Corporation Industrial Automation Company**

Tokyo, JAPAN

Contact: [www.ia.omron.com](http://www.ia.omron.com)

*Regional Headquarters*

**OMRON EUROPE B.V.**

Wegalaan 67-69, 2132 JD Hoofddorp  
The Netherlands  
Tel: (31)2356-81-300/Fax: (31)2356-81-388

**OMRON ELECTRONICS LLC**

2895 Greenspoint Parkway, Suite 200  
Hoffman Estates, IL 60169 U.S.A  
Tel: (1) 847-843-7900/Fax: (1) 847-843-7787

**OMRON ASIA PACIFIC PTE. LTD.**

No. 438A Alexandra Road # 05-05/08 (Lobby 2),  
Alexandra Technopark,  
Singapore 119967  
Tel: (65) 6835-3011/Fax: (65) 6835-2711

**OMRON (CHINA) CO., LTD.**

Room 2211, Bank of China Tower,  
200 Yin Cheng Zhong Road,  
PuDong New Area, Shanghai, 200120, China  
Tel: (86) 21-5037-2222/Fax: (86) 21-5037-2200

**Authorized Distributor:**

© OMRON Corporation 2015 All Rights Reserved.  
In the interest of product improvement,  
specifications are subject to change without notice.

CSM\_1\_2\_1115

Cat. No. **A240-E1-01**

0415 (0415)