

OMRON ELECTRONICS

See full Datasheet below...

onlinecomponents.com
THE ONLINE DISTRIBUTOR OF ELECTRONIC COMPONENTS

BUY NOW

 **MASTER**TM
E L E C T R O N I C S

BUY NOW

masterelectronics.com & onlinecomponents.com
are **authorized** e-commerce distributors
of electronic components.

Round Water-resistant Smartclick Connectors That Reduce Installation Work

- A newly developed lock mechanism that is compatible with round M12 connectors.
- Simply insert the Connectors, then turn them approximately 1/8 of a turn to lock.
- A positive click indicates locking.
- Features the same degree of protection (IP67) as M12 connectors.
- A full line-up of models is planned.
- Connectors with Cables are UL approved.



Refer to *Safety Precautions* on page 17.



Ratings and Specifications

Rated current	4 A
Rated voltage	250 VDC
Contact resistance (connector)	40 mΩ max. (20 mV max., 100 mA max.)
Insulation resistance	1,000 MΩ min. (at 500 VDC)
Dielectric strength (connector)	1,500 VAC for 1 min (leakage current: 1 mA max.)
Degree of protection	IP67 (IEC60529)
Insertion tolerance	50 times min.
Lock strength	Tensile: 100 N/15 s, Torsion: 1 N·m/15 s
Cable holding strength	100 N/15 s (for cable diameter of 6 mm)
Lock operating force	0.1 N·m to 0.25 N·m
Ambient operating temperature range	-25 to 70°C

Recommended Cables for Assembly Connectors

Cable outer diameter (mm)		Core sizes		
		Crimping models	Soldering models	Screw-on models
for 8 dia.	7 to 8 dia.	---	---	0.18 to 0.75 mm ²
for 7 dia.	6 to 7 dia.			
for 6 dia.	5 to 6 dia.	Two types of contacts are available. 0.18 to 0.3 mm ² 0.5 to 0.75 mm ²	0.5 mm ² max.	
for 4 dia.	4 to 5 dia.			
for 3 dia.	3 to 4 dia.			

Materials and Finish

Item	Model	XS5F/H/W/R	XS5M/P	XS5C/G
Contacts	Materials	Phosphor bronze		Brass
	Finish	Nickel base, 0.4-μm gold plating		
Fixtures		Nickel-plated zinc alloy		
Fixtures (Lock)		SUS		
Pin block		PBT resin (UL94V-0)		
O-ring		Rubber		
Overmolding/Cover		Polyester elastomer	---	PBT resin (UL94V-0)
Cable	Fire-retardant, Robot cable	UL AWM2464 CL3, 6-mm dia., 4 cores × AWG20 (0.08/110)	---	---
	Oil-resistant polyurethane cable	6 dia. 4 cores × 0.5 mm ² (0.12/45)	---	---
Seal resin		---	Epoxy resin (UL94V-0)	---
Power supply wires		---	UL1007 AWG20	---

Connection Combinations

OMRON model No.		Smartclick Plug Connectors	M12 Plug Connectors
		XS5H, XS5G, XS5W (plug side), XS5R (plug side), XS5M	XS2H, XS2G, XS2W (plug side), XS2R (plug side), XS2M
Smartclick Socket Connectors	XS5F, XS5C, XS5W (socket side), XS5R (socket side), XS5P	⊙	○
M12 Socket Connectors	XS2F, XS2C, XS2W (socket side), XS2R (socket side), XS2P	○	○

⊙ : Connected by twisting.

○ : Connected by screwing.

Note: The XS□M and XS□P cannot mate with each other.

is a registered trademark of the OMRON Corporation.

XS5W Connectors Connected to Cable, Socket and Plug on Cable Ends

- Fire-retardant, Robot cable
- Oil-resistant Polyurethane Cable

XS5W-D42□-□81-F
XS5W-D42□-□81-P

Dimensions

(Unit: mm)

Straight/straight

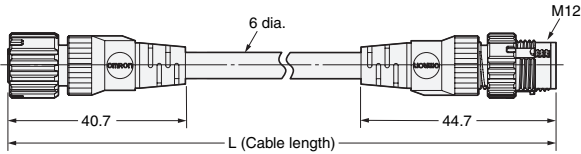

Angled/angled

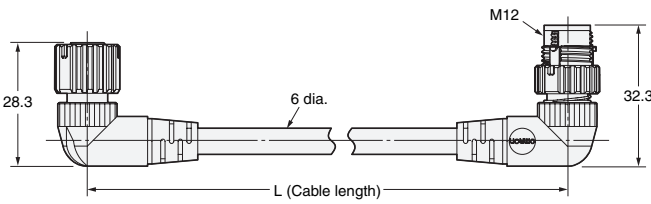

Straight/angled

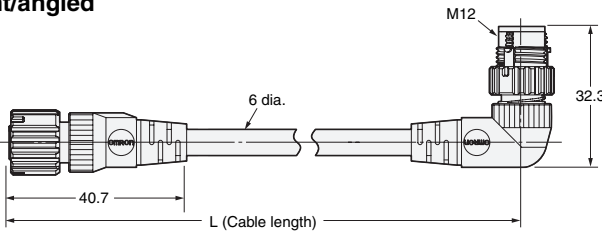

Angled/straight

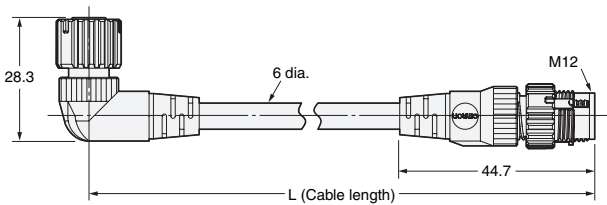

Wiring Diagram for 4 Cores

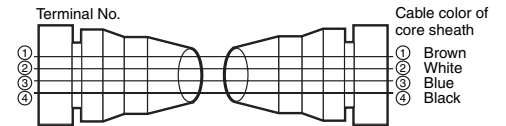

Note: Oil-resistant Polyurethane Cables (XS5W-D42□-□81-P) have black covers. Fire-retardant, Robot cable (XS5W-D42□-□81-F) have warm gray covers.

Model Number Legend

XS5W-D42 **-** **81-**

1
2
3
4
5
6
7
8
9

Use this model number legend to identify products from their model number. When ordering, use a model number from the table in *Ordering Information*.

1. Type

W: Connector connected to cable, plug on cable ends

2. Mating Section Form

D: DC

3. Connector Poles

4: 4 poles

4. Contact Plating

2: 0.4-μm gold plating

5. Cable Connection Direction

- 1: Straight/straight
- 2: Angled/angled
- 3: Straight (XS5F)/angled (XS5H)
- 4: Angled (XS5F)/straight (XS5H)

6. Cable Length

- C: 1 m
- D: 2 m
- E: 3 m
- G: 5 m
- J: 10m

7. Connections

8: ① Brown, ② White, ③ Blue, ④ Black (Numbers inside circles are terminal numbers)

8. Connectors on One End/Both Ends

1: Both ends

9. Cable Specifications

- F: Fire-retardant, Robot cable
- P: Oil-resistant Polyurethane Cable

Ordering Information

Cable specifications	Cable length L (m)	Straight/straight	Angled/angled	Minimum order	UL
		Model			
Fire-retardant, Robot cable	1	XS5W-D421-C81-F	---	10	Yes
	2	XS5W-D421-D81-F	XS5W-D422-D81-F	5	
	3	XS5W-D421-E81-F	---		
	5	XS5W-D421-G81-F	XS5W-D422-G81-F		
	10	XS5W-D421-J81-F	---	1	
Oil-resistant Polyurethane Cable	2	XS5W-D421-D81-P	---	5	---
	5	XS5W-D421-G81-P	---		
	10	XS5W-D421-J81-P	---	1	

Cable specifications	Cable length L (m)	Straight/angled	Angled/straight	Minimum order	UL
		Model			
Fire-retardant, Robot cable	2	XS5W-D423-D81-F	XS5W-D424-D81-F	5	Yes
	5	XS5W-D423-G81-F	XS5W-D424-G81-F		

XS5F Connector Connected to Cable, Socket on One Cable End

- Fire-retardant, Robot cable
- Oil-resistant Polyurethane Cable

XS5F-D42□-□80-F
XS5F-D42□-□80-P

Dimensions

(Unit: mm)

Straight

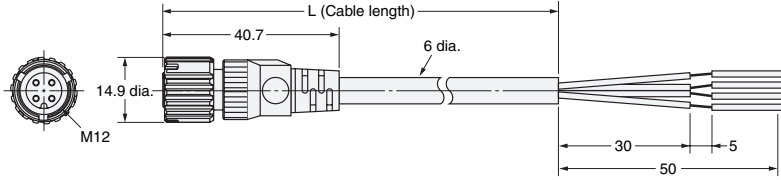

Wiring Diagram for 4 Cores

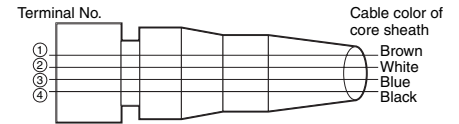

Angled

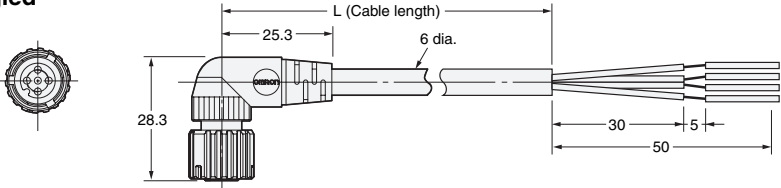

Note: Oil-resistant Polyurethane Cables (XS5F-D42□-□80-P) have black covers. Fire-retardant, Robot cable (XS5F-D42□-□80-F) have warm gray covers.

Model Number Legend

XS5F-D42□-□80-□
1 2 3 4 5 6 7 8 9

Use this model number legend to identify products from their model number. When ordering, use a model number from the table in *Ordering Information*.

1. Type

H: Connector connected to cable, plug on one cable end

2. Mating Section Form

D: DC

3. Connector Poles

4: 4 poles

4. Contact Plating

2: 0.4-μm gold plating

5. Cable Connection Direction

1: Straight
2: Angled

6. Cable Length

C: 1 m D: 2 m E: 3 m
G: 5 m J: 10 m

7. Connections

8: ① Brown, ② White, ③ Blue,
④ Black (Numbers inside circles are terminal numbers.)

8. Connectors on One End/Both Ends

0: One end

9. Cable Specification

F: Fire-retardant, Robot cable
P: Oil-resistant Polyurethane Cable

Ordering Information

Cable specifications	Cable length L (m)	Straight Connectors	Angled Connectors	Minimum order	UL
		Model			
Fire-retardant, Robot cable	1	XS5F-D421-C80-F	XS5F-D422-C80-F	10	Yes
	2	XS5F-D421-D80-F	XS5F-D422-D80-F	5	
	3	XS5F-D421-E80-F	XS5F-D422-E80-F		
	5	XS5F-D421-G80-F	XS5F-D422-G80-F		
	10	XS5F-D421-J80-F	XS5F-D422-J80-F	1	
Oil-resistant Polyurethane Cable	2	XS5F-D421-D80-P	XS5F-D422-D80-P	5	---
	5	XS5F-D421-G80-P	XS5F-D422-G80-P		
	10	XS5F-D421-J80-P	XS5F-D422-J80-P		

XS5H Connector Connected to Cable, Plug on One Cable End

- Fire-retardant, Robot cable
- Oil-resistant Polyurethane Cable

XS5H-D42□-□80-F
XS5H-D42□-□80-P

Dimensions

(Unit: mm)

Straight

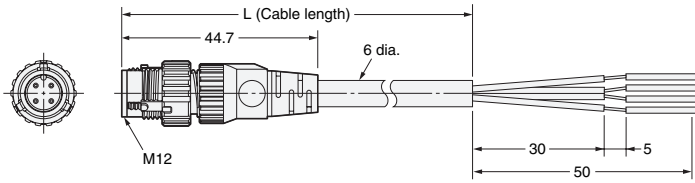

Wiring Diagram for 4 Cores

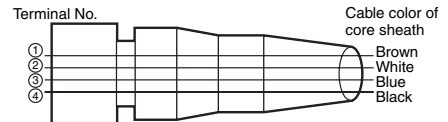

Angled

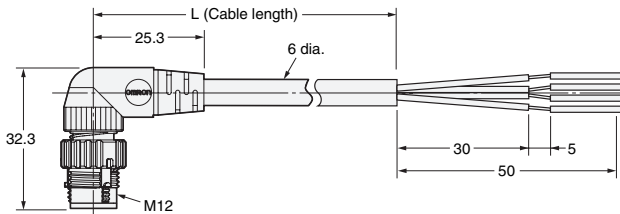

Note: Oil-resistant Polyurethane Cables (XS5H-D42□-□80-P) have black covers. Fire-retardant, Robot cable (XS5H-D42□-□80-F) have warm gray covers.

Model Number Legend

XS5H-D42□-□80-□
1 2 3 4 5 6 7 8 9

Use this model number legend to identify products from their model number. When ordering, use a model number from the table in *Ordering Information*.

1. Type

H: Connector connected to cable, plug on one cable end

2. Mating Section Form

D: DC

3. Connector Poles

4: 4 poles

4. Contact Plating

2: 0.4-μm gold plating

5. Cable Connection Direction

1: Straight
2: Angled

6. Cable Length

A: 0.3 m C: 1 m D: 2 m
G: 5 m

7. Connections

8: ① Brown, ② White, ③ Blue,
④ Black (Numbers inside circles are terminal numbers)

8. Connectors on One End/Both Ends

0: One end

9. Cable Specifications

F: Fire-retardant, Robot cable
P: Oil-resistant Polyurethane Cable

Ordering Information

Cable specifications	Cable length L (m)	Straight Connectors	Angled Connectors	Minimum order	UL
		Model			
Fire-retardant, Robot cable	0.3	XS5H-D421-A80-F	XS5H-D422-A80-F	10	Yes
	1	XS5H-D421-C80-F	XS5H-D422-C80-F		
	2	XS5H-D421-D80-F	XS5H-D422-D80-F	5	
	5	XS5H-D421-G80-F	XS5H-D422-G80-F		
Oil-resistant Polyurethane Cable	0.3	XS5H-D421-A80-P	XS5H-D422-A80-P	10	---
	2	XS5H-D421-D80-P	XS5H-D422-D80-P	5	
	5	XS5H-D421-G80-P	XS5H-D422-G80-P		

XS5G Assembly Connector Plugs

Dimensions

(Unit: mm)

XS5G-D4C□ (Crimping Model)
XS5G-D42□ (Soldering Model)
Straight Connectors

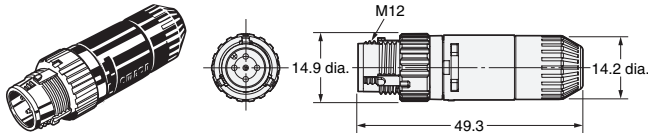

XS5G-D42□ (Soldering Model)
Angled Connectors

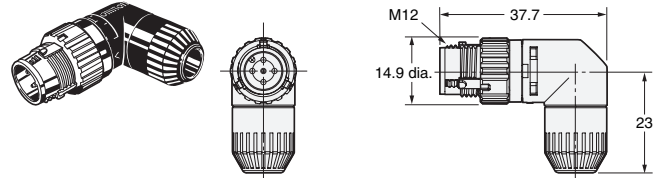

XS5G-D□S□ (Screw-on Connectors, Applicable Cable Outer Diameter: 7 or 8 mm)
Straight Connectors

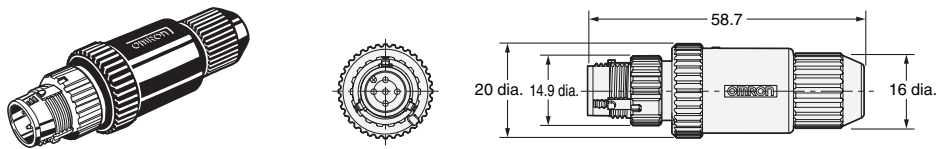

XS5G-D□S□ (Screw-on Connectors, Applicable Cable Outer Diameter: 3, 4, or 6 mm)
Straight Connectors

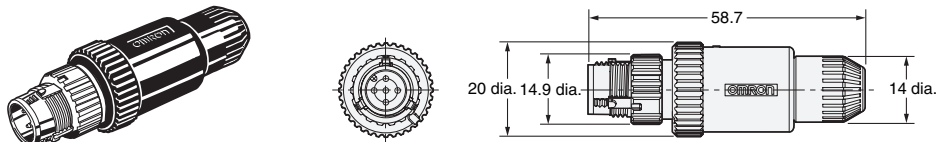

XS5G-D□S□ (Screw-on Connectors)
Angled Connectors

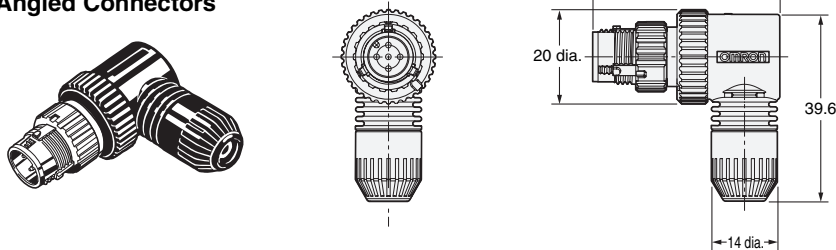

Ordering Information

No. of poles	Connection method	Suitable cable dia. (mm)	Straight Connectors	Angled Connectors	Minimum order
			Model		
4	Crimping	6 mm (5 to 6)	XS5G-D4C1	---	50
		4 mm (4 to 5)	XS5G-D4C3	---	
		3 mm (3 to 4)	XS5G-D4C5	---	
	Soldering	6 mm (5 to 6)	XS5G-D421	XS5G-D422	
		4 mm (4 to 5)	XS5G-D423	XS5G-D424	
		3 mm (3 to 4)	XS5G-D425	XS5G-D426	
	Screw-on	6 mm (5 to 6)	XS5G-D4S1	XS5G-D4S2	
		4 mm (4 to 5)	XS5G-D4S3	XS5G-D4S4	
		3 mm (3 to 4)	XS5G-D4S5	XS5G-D4S6	
8 mm (7 to 8)		XS5G-D4S7	---		
7 mm (6 to 7)		XS5G-D4S9	---		
6 mm (5 to 6)		XS5G-D5S1	---		
5	Screw-on	4 mm (4 to 5)	XS5G-D5S3	---	
		3 mm (3 to 4)	XS5G-D5S5	---	
		8 mm (7 to 8)	XS5G-D5S7	---	
		7 mm (6 to 7)	XS5G-D5S9	---	
		6 mm (5 to 6)	---	---	

Note: XS5G Screw-on Plugs cannot be connected to side by side to the CN1 and CN2 connectors of XS2R or XS5R Y-Joint Sockets/Plugs.

XS5U (Crimping Pin for XS5G)

Dimensions

(Unit: mm)

XS5U-312□
Plug Pin

* A special tool must be used for crimping. For details, refer to page 13.

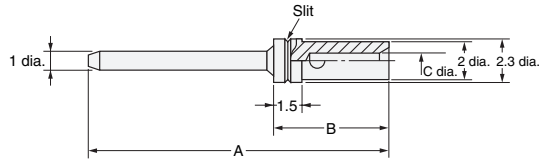
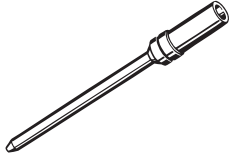

Dimensions

Model	Suitable core size (mm ²)	Dimension (mm)			No. of slits
		A	B	C	
XS5U-3121	0.18 to 0.3	22.6	6.1	0.8	1
XS5U-3122	0.5 to 0.75	22.7	6.2	1.3	0

Ordering Information

Suitable core size (mm ²)	Model	Minimum order
0.18 to 0.3	XS5U-3121	100
0.5 to 0.75	XS5U-3122	

Note: Orders are accepted in multiples of the minimum order.

XS5C Assembly Connector Sockets

Dimensions

(Unit: mm)

XS5C-D4C□ (Crimping Model)
XS5C-D42□ (Soldering Model)
Straight Connectors

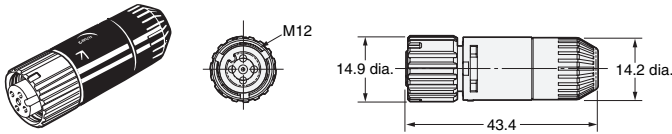

XS5C-D4C□ (Crimping Model)
XS5C-D42□ (Soldering Model)
Angled Connectors

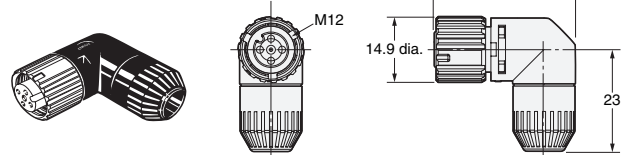

XS5C-D□S□ (Screw-on Connectors, Applicable Cable Outer Diameter: 7 or 8 mm)
Straight Connectors

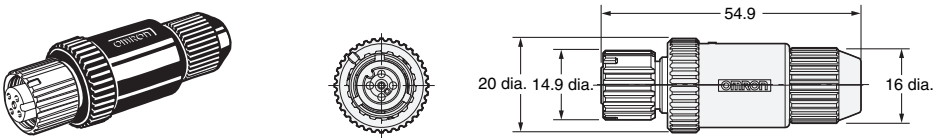

XS5C-D□S□ (Screw-on Connectors, Applicable Cable Outer Diameter: 3, 4, or 6 mm)
Straight Connectors

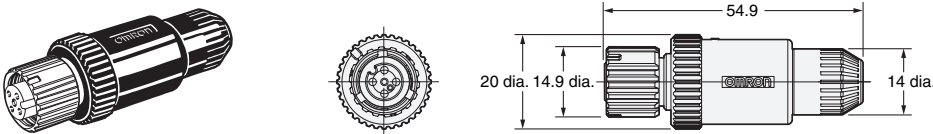

XS5C-D□S□ (Screw-on Connectors)
Angled Connectors

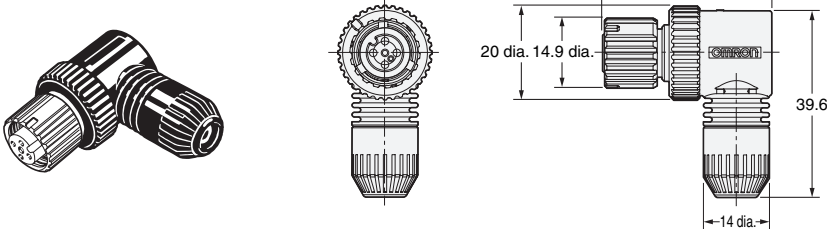

Ordering Information

No. of poles	Connection method	Suitable cable dia. (mm)	Straight Connectors	Angled Connectors	Minimum order
			Model		
4	Crimping	6 mm (5 to 6)	XS5C-D4C1	XS5C-D4C2	50
		4 mm (4 to 5)	XS5C-D4C3	XS5C-D4C4	
		3 mm (3 to 4)	XS5C-D4C5	XS5C-D4C6	
	Soldering	6 mm (5 to 6)	XS5C-D421	XS5C-D422	
		4 mm (4 to 5)	XS5C-D423	XS5C-D424	
		3 mm (3 to 4)	XS5C-D425	XS5C-D426	
	Screw-on	6 mm (5 to 6)	XS5C-D4S1	XS5C-D4S2	
		4 mm (4 to 5)	XS5C-D4S3	XS5C-D4S4	
		3 mm (3 to 4)	XS5C-D4S5	XS5C-D4S6	
		8 mm (7 to 8)	XS5C-D4S7	---	
5	Screw-on	7 mm (6 to 7)	XS5C-D4S9	---	
		6 mm (5 to 6)	XS5C-D5S1	---	
		4 mm (4 to 5)	XS5C-D5S3	---	
		3 mm (3 to 4)	XS5C-D5S5	---	
		8 mm (7 to 8)	XS5C-D5S7	---	
		7 mm (6 to 7)	XS5C-D5S9	---	

XS5U (Crimping Pin for XS5C)

Dimensions

(Unit: mm)

XS5U-222□
Socket Pin

* A special tool must be used for crimping. For details, refer to page 13.

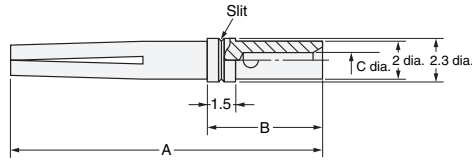
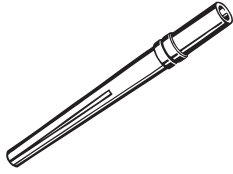

Dimensions

Model	Suitable core size (mm ²)	Dimension (mm)			No. of slits
		A	B	C	
XS5U-2221	0.18 to 0.3	16.7	6.1	0.8	1
XS5U-2222	0.5 to 0.75	16.8	6.2	1.3	0

Ordering Information

Suitable core size (mm ²)	Model	Minimum order
0.18 to 0.3	XS5U-2221	100
0.5 to 0.75	XS5U-2222	

Orders are accepted in multiples of the minimum order.

XS5R Y-Joint Plug/Socket Connectors

Dimensions

(Unit: mm)

XS5R-D426-@11-F Connectors on Both Ends (Y-Joint Plug/Socket)

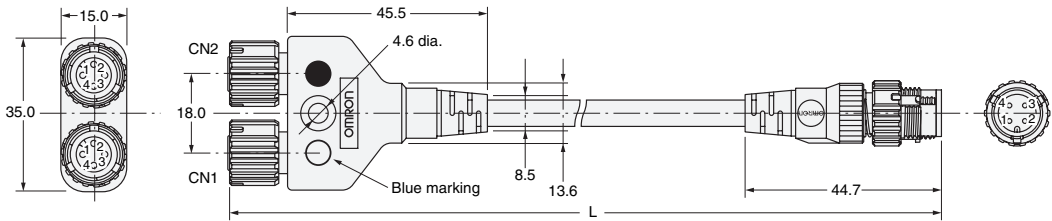

Wiring Diagram

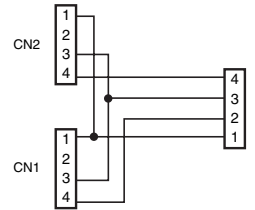

XS5R-D426-@10-F Connectors on One Cable End (Y-Joint Socket)

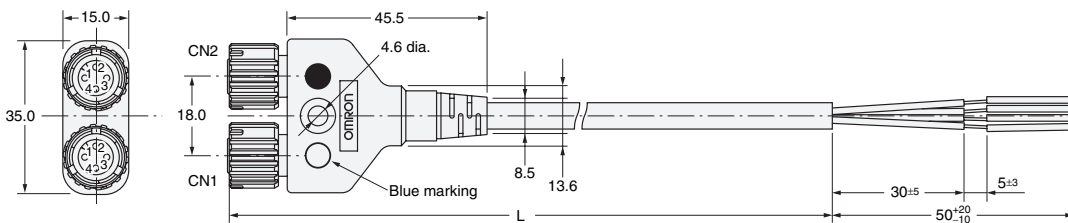

Wiring Diagram

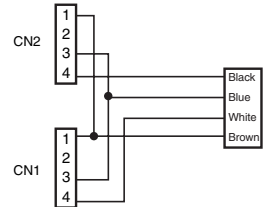

XS5R-D426-@ Y-Joint Plug/Socket without Cable

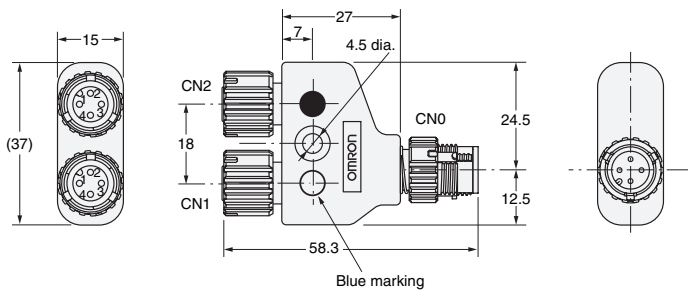

Wiring Diagram

XS5R-D426-1

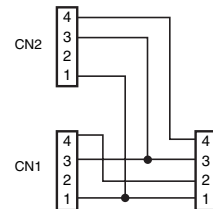

XS5R-D426-5

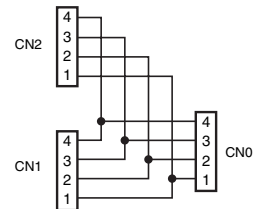

Ordering Information

Cable	Connector	Cable length (m)	Model	Minimum order
With cable	Connectors on both cable ends	0.5	XS5R-D426-B11-F	10
		1	XS5R-D426-C11-F	
		2	XS5R-D426-D11-F	
	Connector on one cable end	3	XS5R-D426-E11-F	5
		2	XS5R-D426-D10-F	
	5	XS5R-D426-G10-F		
Cable	Connector	Cable length (m)	Model	Minimum order
With no cable	Y-Joint Plug/Socket	—	XS5R-D426-1	10
			XS5R-D426-5	

Note 1. Ask your OMRON representative about other specifications.

2. XS2G/XS5G Assembled Connectors with screw connections cannot be connected to both CN1 and CN2 at the same time.

XS5P Panel-mounting Sockets

Dimensions

(Unit: mm)

XS5P-D426-5 Panel-mounting Sockets with Rear Locks

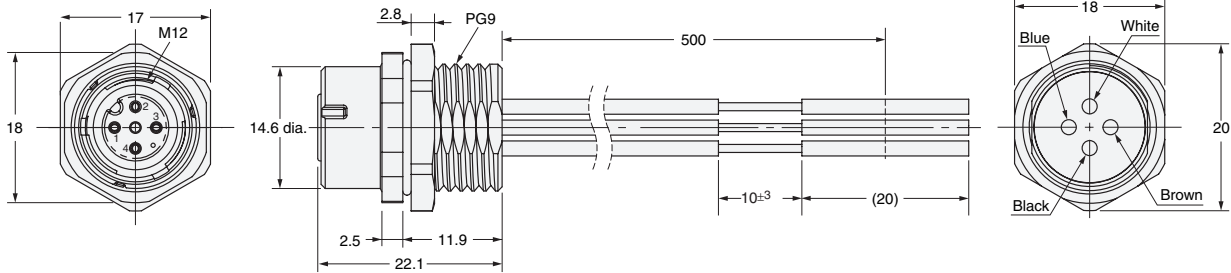

XS5P-D427-5 Panel-mounting Sockets with Front Locks

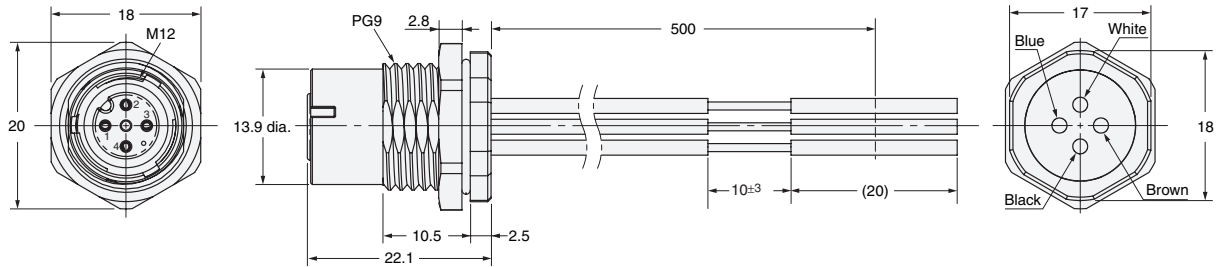

Panel Cutout

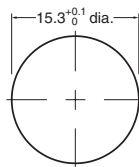

Panel Cutout Dimension
Panel thickness = 1 to 4 mm

Note 1. The panel cutout dimension is the same for Front-locking and Rear-locking Sockets.

2. Rotational positioning is not possible for connector rotation.

Wiring and Wire Specifications

Wiring

Pin number	Color
1	Brown
2	White
3	Blue
4	Black

Wire Specifications

Item	Specification	
Specification	UL1007	
Nominal size	AWG20	
Configuration	Number of wires	21
	Wire diameter	0.18
	Standard outer diameter	1.8

Ordering Information

Type	Lock	Cable length (m)	Model	Minimum order
With cable	Rear lock	0.5	XS5P-D426-5	10
	Front lock		XS5P-D427-5	

XS5M Panel-mounting Plugs

Dimensions

(Unit: mm)

XS5M-D426-5 Panel-mounting Plugs with Rear Locks

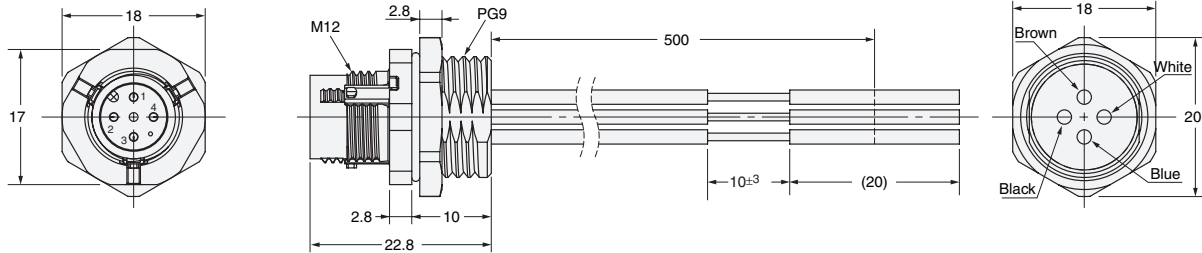

XS5M-D427-5 Panel-mounting Plugs with Front Locks

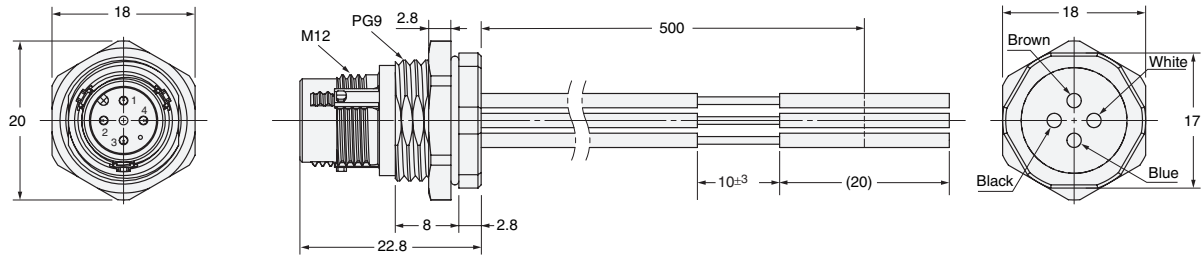

Panel Cutout



Panel Cutout Dimension
Panel thickness = 1 to 4 mm

- Note 1. The panel cutout dimension is the same for Front-locking and Rear-locking Sockets.
2. Rotational positioning is not possible for connector rotation.

Wiring and Wire Specifications

Wiring

Pin number	Color
1	Brown
2	White
3	Blue
4	Black

Wire Specifications

Item	Specification	
Specification	UL1007	
Nominal size	AWG20	
Configuration	Number of wires	21
	Wire diameter	0.18
	Standard outer diameter	1.8

Ordering Information

Type	Lock	Cable length (m)	Model	Minimum order
With cable	Rear lock	0.5	XS5M-D426-5	10
	Front lock		XS5M-D427-5	

Tools

Crimp Tool
XY2F-0002

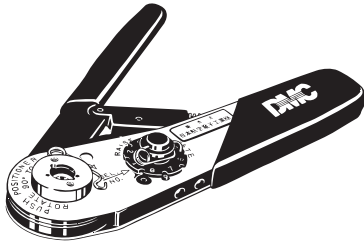

Use the Crimp Tool to crimp a cable core to the XS5U or XS2U Crimping Pin used with the XS□C or XS□G Crimping Connector.

- The XY2F-0002 Crimp Tool is DMC's AFM8 (M2520/2-01).
- Mount the XY2F-0003 Locator (sold separately) to the locator guide of the Crimp Tool with a screw provided with the XY2F-0003 Locator.

Locator
XY2F-0003

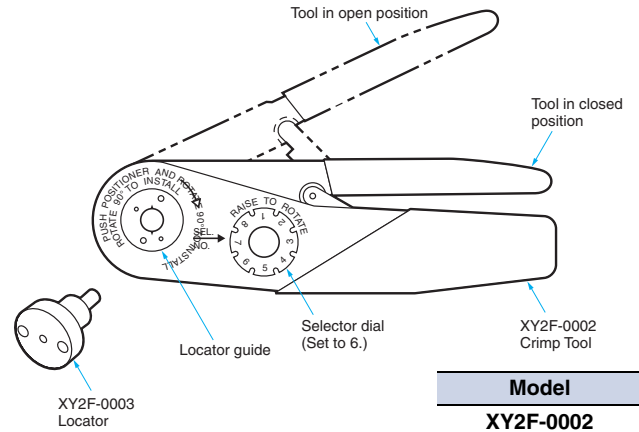

Model
XY2F-0002
XY2F-0003

Pin-block Extraction Tool
XY2F-0001

Use this tool to extract a Pin Block from the covers in order to make wiring changes or corrections after the cover has been mounted to the pin block for Connector Assemblies (XS□C/XS□G, soldering/crimping).

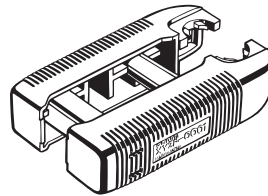

Model
XY2F-0001

Extraction Procedure

(1) Disconnecting Components

- Disconnect all components on the cap side from the cover.

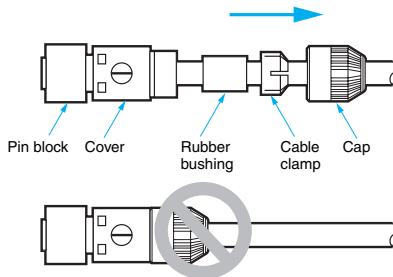

- Make sure that the pin block is outside the Tool.

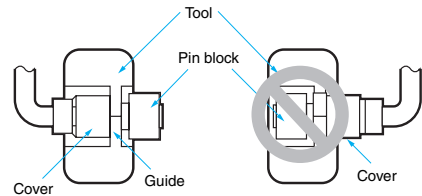

- Press the Tool so that the guides of the Tool are in close contact. Then pull the pin block straight.

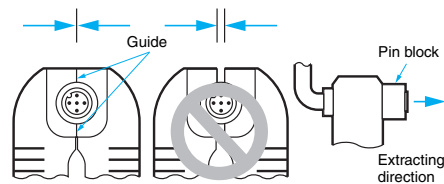

(2) Extracting Pin Block

- Insert the claws of the Tool into the four holes of the cover.

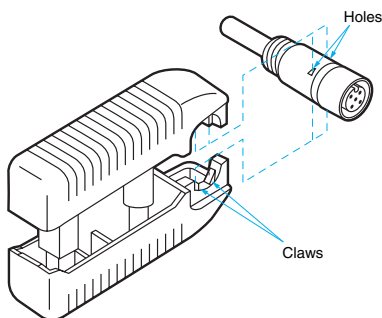

Precaution for Safe Use

- The pin block must not be extracted from the same Connector more than 3 times, otherwise the proper degree of protection of the pin block or Connector will not be maintained.

Assembly Procedure for XS5C/XS5G Connector Assemblies

(1) Connector and Cable External Diameters

- Connectors for 6-, 4-, and 3-mm-diameter Cables (i.e., Cables that are 5 to 6, 4 to 5, and 3 to 4 mm in diameter respectively) are available. When assembling a Connector used with a cable, make sure that the external diameter of the Connector is suited to that of the cable.
 - Connectors for 6-mm-diameter Cables use white cable clamps. Connectors for 4- and 3-mm-diameter Cables use black cable clamps.
- A watertight bushing for 6-mm-diameter Cable has no stripe, that for 4-mm-diameter Cable has a single stripe, and that for 3-mm-diameter Cable has two stripes.

Note: When connecting a commercially available cable to a connector assembly, use a cable with an outside diameter of 3 to 6 mm and core sizes of 0.18 to 0.75 mm² for crimping connectors and 0.5 mm² maximum for soldering connectors.

(2) Component Insertion

Crimping/Soldering Connectors

Straight Connectors

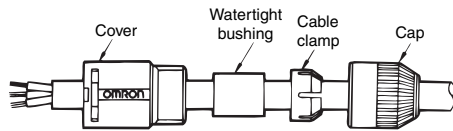

Angled Connectors

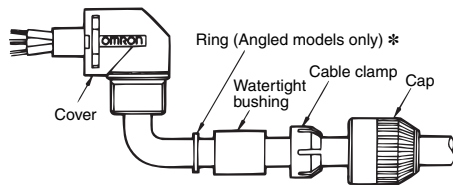

* A ring is not required for Screw-on Connectors.

- As shown in the above illustration, connect the above components to the Cable with its end processed.

Screw-on Connectors

Confirm that you have all of the required parts.

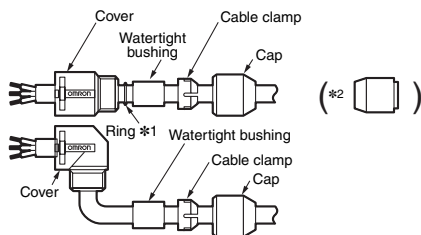

Insulation caps and insulation tubes are included with 5-pole Connectors (XS2C-D5S□ and XS2G-D5S□).

- *1. Rings are not required with 7-mm and 8-mm cables.
- *2. Insert the waterproof bushing for 7-mm and 8-mm cables in the direction shown in the diagram.

(3) Wiring (Processing Cable Ends)

Soldering Connectors

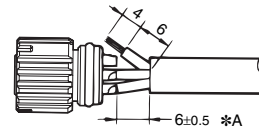

- Strip 10 mm of the Cable sheath and 4 mm of each core.
- Before soldering cores and solder cup pins together, solder-coat each of them.
- The following conditions are recommended for soldering each solder cup pin.
 - Soldering iron: 30 to 60 W
 - Soldering temperature: 280°C to 340°C
 - Soldering period: 3 s max.
- The length marked *A should be 6.5 mm max., otherwise the proper degree of protection of the connector will not be maintained.

Crimping Connectors

Crimping

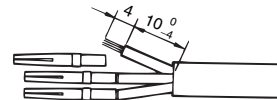

- Strip 14 mm of the Cable sheath and 4 mm of each core.
- Make sure that each core is not damaged and its end strands are not spread out.
- Mount the XY2F-0003 Locator to XY2F-0002 Crimping Tool, both of which are sold separately, and set the selector dial of the Crimping Tool to 6 for the XS5U-□□21 and to 7 for the XS5U-□□22.
- After mounting the crimping pins to the Locator, fully insert the cores to the crimping pins.
- Squeeze the handle of the Crimp Tool to press-fit the cores to the crimping pins. (Squeeze the handle firmly until the handle automatically returns to the release position.)

Wiring

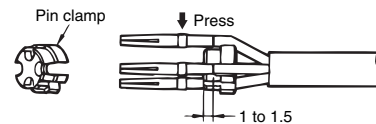

- After press-fitting the cores to the pins, insert the pins into the pin clamp as shown in the illustration. Then make sure that the lead colors correspond to the pin clamp numbers that are identical to the connector pin numbers.

Insertion

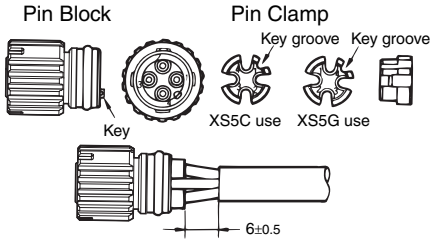

- Tentatively insert the pins to the pin block holes so that the key on the pin block will coincide with the key groove on the pin clamp. Then insert the cable along with the pin clamp.

Screw-on Connectors

Cable End Processing

• Four-pole Connectors

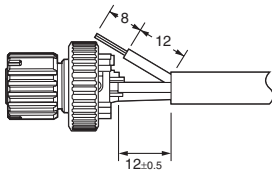

- Loosen the screws on pins 1 to 4 and insert the cores according to the pin numbers.

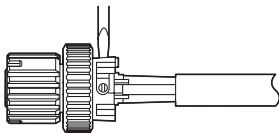

- Use the dedicated Screwdriver (XW4Z-00B)* and tighten the screws securely so that the cores do not pull out (tightening torque: 0.15 to 0.2 N·m).

• Five-pole Connectors

- Strip the cable sheath for a total of 15 mm and strip the core covering for 8 mm for the core to connect to pin 5.

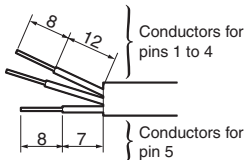

- Connect the core to pin 5 (in the center) first.
- Insert the core from the side of the hold with the tab and tighten the screw securely (tightening torque: 0.15 to 0.2 N·m), and then cut off the excess wire with wire cutters.

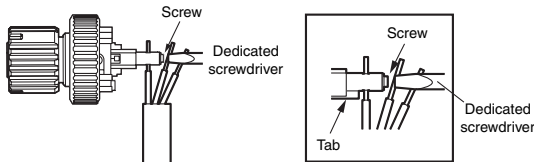

- Bend the cable as shown below, attached the enclosed insulation cap, and then strip the other cores.

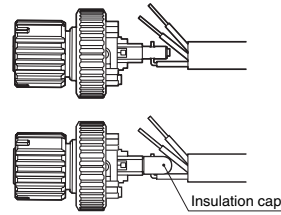

- Connect the cores to pins 1 to 4.

Connecting Shielded Cables to Five-pole Connectors

- Place the insulation tub on the drain line of the shield and connect it to the terminal.
- Tighten the screw and then check visually to see if there is insulation between the cores.

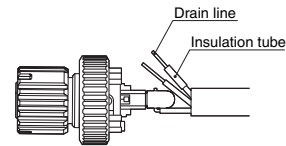

- Connect the cores to pins 1 to 4.

- * When tightening the screws, use the dedicated XW4Z-00B Screwdriver that matches with the screw-slot dimensions.

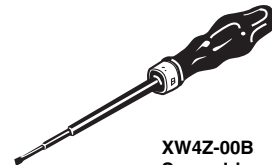

XW4Z-00B Screwdriver

(4) Inserting Pin Block

Pin Block (Soldering Model)

Cover (Straight Model)

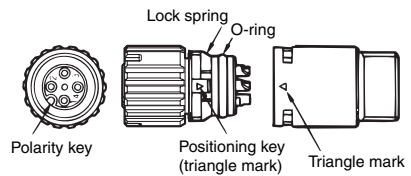

(Crimping Model)

(Angled Model)

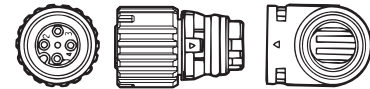

- Mount the cover to the pin block so that the triangle mark on the pin block will coincide with the triangle mark on the cover.
- If the cover is used for an Angled model, the relationship between the position of the polarity key on the engaged side and cable connection direction will be determined by the direction in which the positioning key is inserted into the cover, which can be rotated by 90°.
- Fully insert the positioning key until the positioning key is hidden by the casing.

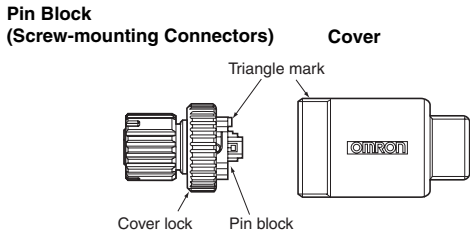

- Align the triangular marks on the pin block and cover and insert the pin block into the cover.
- Press them together firmly (0.39 to 0.49 N·m) until the pin block does not come out of the cover.

(5) Mounting Cap

- After mounting the cover to the pin block and the cover snaps into place, tighten the cap securely by hand within a torque of 0.39 and 0.49 N·m.

Note: If the cap is not tightened securely enough, the degree of protection (IP67) may not be maintained or vibration may cause the cap to become loose. Do not tighten the cap with pliers or similar tools; they may damage the cap.

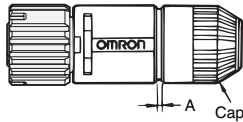

- After fully tightening the cap, length A should be approximately one of the following according to the cable external diameter and the Connector model.

Connector	Cable external diameter (mm)			
	6 mm	5 mm	4 mm	3 mm
For 6-mm-dia. cable	1	0	---	---
For 4-mm-dia. cable	---	2	1	---
For 3-mm-dia. cable	---	---	2	1

(6) After Assembly

- Confirm the insulation between cores after completing assembly.

Recommended Cables

When connecting a commercially available cable to a connector assembly, use a cable with an outside diameter of 3 to 6 mm and core sizes of 0.18 to 0.75 mm² for crimping connectors and 0.5 mm² maximum for soldering connectors.

Connector Arrangement

For safety, when constructing a connection system between a Sensor and panel with a connector, make sure that the connector plug is on the Sensor side and the connector socket is on the panel side (i.e., the female pins are located on the power-supply side).

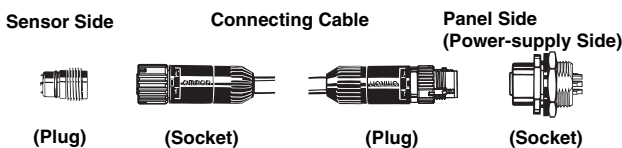

Connecting the XS5

1. Connecting the XS5 Plug and Socket

- Align the projection on the plug cover with the polarity key on the socket, then insert the plug all the way in.

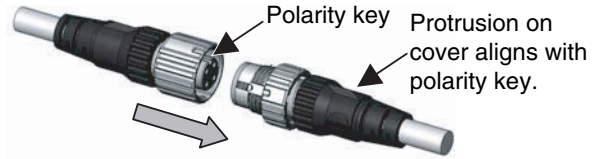

- Hold the knurled socket grip, then insert the projection on the plug into the groove of the socket.



- Turn the knurled grips of the socket clockwise approximately 45 degrees in respect to the plug. A click will indicate that the Connectors are locked. The locking condition can also be confirmed by the alignment marks on the plug and socket.

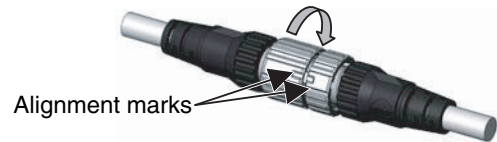

2. Connecting the XS5 and XS2

- Align the projection on the plug cover with the polarity key on the socket, then insert the plug all the way in.
- In the same way as when connecting two XS2 Connectors, screw the knurled grip in the clockwise direction.
- Use your fingers to tighten the Connectors sufficiently.

Safety Precautions

Precautions for Correct Use

Do not use the Connectors in an atmosphere or environment that exceeds the specifications.

Connector Connection and Disconnection

- When connecting or disconnecting Connectors, be sure to hold the Connectors by hand.
- Do not hold the cable when disconnecting Connectors.
- When mating Connectors, be sure to insert the plug all the way to the back of the socket before attempting to lock the Connectors.
- Do not use tools of any sort to mate the Connectors. Always use your hands. Pliers or other tools may damage the Connectors.
- When mating the Connectors to XS2 or other M12 Connectors, tighten the lock by hand to a torque of 0.39 to 0.49 N·m.

Wiring

- Always confirm wiring diagrams before wiring sensors, limit switches, or other devices.
- Lay the cables so that external force is not applied to the Connectors. Otherwise, the degree of protection (IP67) may not be achieved.

Degree of Protection

- The degree of protection of Connectors (IP67) is not for a fully watertight structure. Do not use the Connectors underwater.
- Do not step on or place any objects on the Connectors. Doing so may damage the Connectors.

General Precautions

- Do not pull excessively on the Connectors or cables. Do not install the Connectors or cables in any way that would place a load directly on the mating section or cable connections. Doing so can damage the Connectors or break the wires inside the cables.
- Install the Connectors and cables where they will not be stepped on to prevent the wires inside the cables from being broken and to prevent the Connectors from being damaged. If the Connectors or cables must be installed where they might be stepped on, protect them with covers.
- Refer to the specifications for your cables before bending the cables and do not bend them past their minimum bending radius.
- If sensors or switches are not attached during installation, protect the mating surface of the Connector with a XS2Z-22 Waterproof Cover or XS2Z-14/15 Dust Cover.

Read and Understand This Catalog

Please read and understand this catalog before purchasing the products. Please consult your OMRON representative if you have any questions or comments.

Warranty and Limitations of Liability

WARRANTY

OMRON's exclusive warranty is that the products are free from defects in materials and workmanship for a period of one year (or other period if specified) from date of sale by OMRON.

OMRON MAKES NO WARRANTY OR REPRESENTATION, EXPRESS OR IMPLIED, REGARDING NON-INFRINGEMENT, MERCHANTABILITY, OR FITNESS FOR PARTICULAR PURPOSE OF THE PRODUCTS. ANY BUYER OR USER ACKNOWLEDGES THAT THE BUYER OR USER ALONE HAS DETERMINED THAT THE PRODUCTS WILL SUITABLY MEET THE REQUIREMENTS OF THEIR INTENDED USE. OMRON DISCLAIMS ALL OTHER WARRANTIES, EXPRESS OR IMPLIED.

LIMITATIONS OF LIABILITY

OMRON SHALL NOT BE RESPONSIBLE FOR SPECIAL, INDIRECT, OR CONSEQUENTIAL DAMAGES, LOSS OF PROFITS OR COMMERCIAL LOSS IN ANY WAY CONNECTED WITH THE PRODUCTS, WHETHER SUCH CLAIM IS BASED ON CONTRACT, WARRANTY, NEGLIGENCE, OR STRICT LIABILITY.

In no event shall the responsibility of OMRON for any act exceed the individual price of the product on which liability is asserted.

IN NO EVENT SHALL OMRON BE RESPONSIBLE FOR WARRANTY, REPAIR, OR OTHER CLAIMS REGARDING THE PRODUCTS UNLESS OMRON'S ANALYSIS CONFIRMS THAT THE PRODUCTS WERE PROPERLY HANDLED, STORED, INSTALLED, AND MAINTAINED AND NOT SUBJECT TO CONTAMINATION, ABUSE, MISUSE, OR INAPPROPRIATE MODIFICATION OR REPAIR.

Application Considerations

SUITABILITY FOR USE

OMRON shall not be responsible for conformity with any standards, codes, or regulations that apply to the combination of products in the customer's application or use of the products.

At the customer's request, OMRON will provide applicable third party certification documents identifying ratings and limitations of use that apply to the products. This information by itself is not sufficient for a complete determination of the suitability of the products in combination with the end product, machine, system, or other application or use.

The following are some examples of applications for which particular attention must be given. This is not intended to be an exhaustive list of all possible uses of the products, nor is it intended to imply that the uses listed may be suitable for the products:

- Outdoor use, uses involving potential chemical contamination or electrical interference, or conditions or uses not described in this catalog.
- Nuclear energy control systems, combustion systems, railroad systems, aviation systems, medical equipment, amusement machines, vehicles, safety equipment, and installations subject to separate industry or government regulations.
- Systems, machines, and equipment that could present a risk to life or property.

Please know and observe all prohibitions of use applicable to the products.

NEVER USE THE PRODUCTS FOR AN APPLICATION INVOLVING SERIOUS RISK TO LIFE OR PROPERTY WITHOUT ENSURING THAT THE SYSTEM AS A WHOLE HAS BEEN DESIGNED TO ADDRESS THE RISKS, AND THAT THE OMRON PRODUCTS ARE PROPERLY RATED AND INSTALLED FOR THE INTENDED USE WITHIN THE OVERALL EQUIPMENT OR SYSTEM.

PROGRAMMABLE PRODUCTS

OMRON shall not be responsible for the user's programming of a programmable product, or any consequence thereof.

Disclaimers

CHANGE IN SPECIFICATIONS

Product specifications and accessories may be changed at any time based on improvements and other reasons.

It is our practice to change model numbers when published ratings or features are changed, or when significant construction changes are made. However, some specifications of the products may be changed without any notice. When in doubt, special model numbers may be assigned to fix or establish key specifications for your application on your request. Please consult with your OMRON representative at any time to confirm actual specifications of purchased products.

DIMENSIONS AND WEIGHTS

Dimensions and weights are nominal and are not to be used for manufacturing purposes, even when tolerances are shown.

PERFORMANCE DATA

Performance data given in this catalog is provided as a guide for the user in determining suitability and does not constitute a warranty. It may represent the result of OMRON's test conditions, and the users must correlate it to actual application requirements. Actual performance is subject to the OMRON Warranty and Limitations of Liability.

ERRORS AND OMISSIONS

The information in this document has been carefully checked and is believed to be accurate; however, no responsibility is assumed for clerical, typographical, or proofreading errors, or omissions.

2012.7

In the interest of product improvement, specifications are subject to change without notice.

OMRON Corporation
Industrial Automation Company

<http://www.ia.omron.com/>

(c)Copyright OMRON Corporation 2012 All Right Reserved.