

Half-pitch Board-to-Board Connectors XH3

**Screw Mount Eliminated to Save Space.
Adjustable Stacking Height of 12 to 20 mm.**

- The stacking height can be adjusted in 1-mm increments.
- Mating length of 3.1 mm and a pitch of 1.27 mm for high-density mounting in double-row arrangements.
- All models incorporate fastening pins to secure the terminals, thus preventing floating or falling over during soldering.
- Leaf contact construction enables smooth mating and resistance to bending.
- The XH3 conforms to EN, IEC, UL (file no. E103202), and CSA (file no. LR62678).

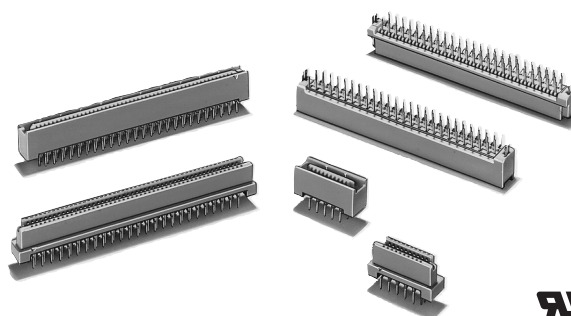

Ordering Information

Plugs - - Straight and Right-angle Through-hole PCB Terminals

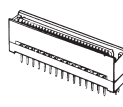
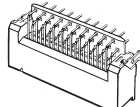
Appearance						
	No Fastening Pin	With PCB Fastening Pins (See Note)				
	(Standard)	(Standard)	(2-mm increments)	(4-mm increments)	(Standard)	
No. of contacts	Straight Terminals					Right-angle Terminals
20	XH3A-2041	XH3A-2041-A	XH3A-2041-2A	XH3A-2041-4A		---
30	XH3A-3041	XH3A-3041-A	XH3A-3041-2A	XH3A-3041-4A		XH3A-3042-A
40	XH3A-4041	XH3A-4041-A	XH3A-4041-2A	XH3A-4041-4A		XH3A-4042-A
50	XH3A-5041	XH3A-5041-A	XH3A-5041-2A	XH3A-5041-4A		XH3A-5042-A
60	XH3A-6041	XH3A-6041-A	XH3A-6041-2A	XH3A-6041-4A		XH3A-6042-A
68	XH3A-6841	XH3A-6841-A	XH3A-6841-2A	XH3A-6841-4A		XH3A-6842-A
80	XH3A-8041	XH3A-8041-A	XH3A-8041-2A	XH3A-8041-4A		XH3A-8042-A
100	XH3A-0141	XH3A-0141-A	XH3A-0141-2A	XH3A-0141-4A		XH3A-0142-A
120	XH3A-0241	XH3A-0241-A	XH3A-0241-2A	XH3A-0241-4A		---

Note: Applicable board thickness is 1.6 mm.

Sockets - - Straight and Right-angle Through-hole PCB Terminals

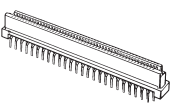
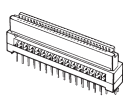
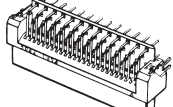
Appearance						
	No Fastening Pin	With PCB Fastening Pins (See Note)				
	(Standard)	(Standard)	(1-mm increment)	(3-mm increments)	(4-mm increments)	(Standard)
No. of contacts	Straight Terminals					Right-angle
20	XH3B-2041	XH3B-2041-A	XH3B-2041-1A	XH3B-2041-3A	XH3B-2041-4A	---
30	XH3B-3041	XH3B-3041-A	XH3B-3041-1A	XH3B-3041-3A	XH3B-3041-4A	XH3B-3042-A
40	XH3B-4041	XH3B-4041-A	XH3B-4041-1A	XH3B-4041-3A	XH3B-4041-4A	XH3B-4042-A
50	XH3B-5041	XH3B-5041-A	XH3B-5041-1A	XH3B-5041-3A	XH3B-5041-4A	XH3B-5042-A
60	XH3B-6041	XH3B-6041-A	XH3B-6041-1A	XH3B-6041-3A	XH3B-6041-4A	XH3B-6042-A
68	XH3B-6841	XH3B-6841-A	XH3B-6841-1A	XH3B-6841-3A	XH3B-6841-4A	XH3B-6842-A
80	XH3B-8041	XH3B-8041-A	XH3B-8041-1A	XH3B-8041-3A	XH3B-8041-4A	XH3B-8042-A
100	XH3B-0141	XH3B-0141-A	XH3B-0141-1A	XH3B-0141-3A	XH3B-0141-4A	XH3B-0142-A
120	XH3B-0241	XH3B-0241-A	XH3B-0241-1A	XH3B-0241-3A	XH3B-0241-4A	---

Note: Applicable board thickness is 1.6 mm.

Specifications

■ Ratings and Characteristics

Rated current	0.5 A
Rated voltage	125 VAC
Contact resistance (See note.)	30 mΩ max. (20 mV max., 100 mA max.)
Insulation resistance	1,000 MΩ min. (at 500 VDC)
Dielectric strength	650 VAC for 1 min (leakage current: 1 mA max.)
Overall insertion force	80 gf (0.78 N) max. per contact
Overall removal force	10 gf (0.10 N) min. per contact
Insertion tolerance	400 times
Ambient temperature	Operating: -55 to 105°C (with no icing)

Note: The contact resistance is for the XH3A-□□41 combined with the XH3B-□□41.

■ Materials and Finish

Item	Type	Plug	Socket
Housing		PBT resin with glass (UL94V-0)/gray	
Locator		PBT resin with glass (UL94V-0)/gray	
Contacts	Mating end	Phosphor bronze/nickel base, gold/palladium plating	
	Terminal	Phosphor bronze/nickel base, gold flash plating	
Fastening pins		Phosphor bronze/tin plating	

Engineering Data

■ Mating Diagram

Vertical/Horizontal/Stacking

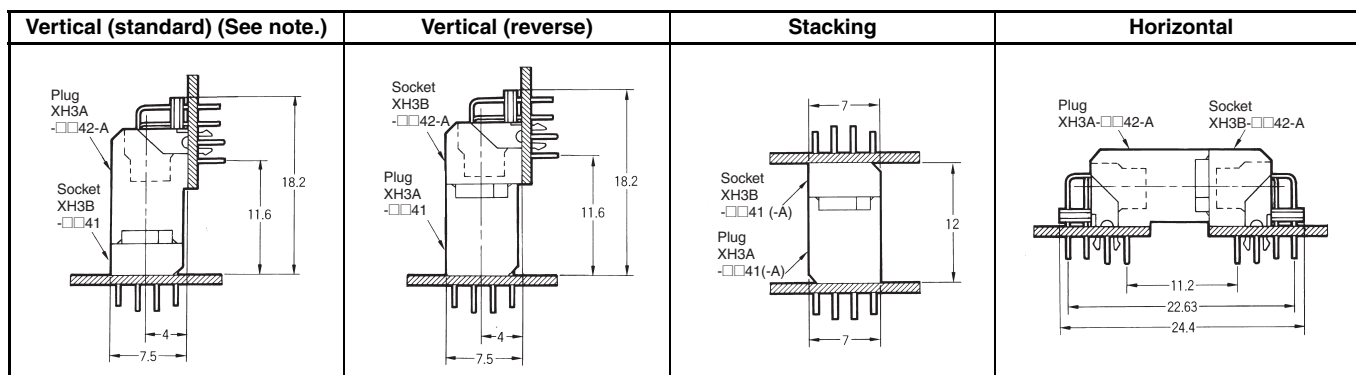

Note: The function of the standard and reverse models is the same as that of the standard XC5 DIN Connectors.

Stacking Space Adjustable Models

Stacking space	12 mm	13 mm	14 mm	15 mm	16 mm
Mating diagram					
Stacking space	17 mm	18 mm	19 mm	20 mm	
Mating diagram					

Combinations

Plug	Socket	XH3B-□□41 XH3B-□□41-A	1-mm increment XH3B-□□41-1A	3-mm increments XH3B-□□41-3A	4-mm increments XH3B-□□41-4A
XH3A-□□41, XH3A-□□41-A		12 mm	13 mm	(15 mm) (See note.)	(16 mm) (See note.)
2-mm increment XH3A-□□41-2A		14 mm	15 mm	(17 mm) (See note.)	18 mm
4-mm increment XH3A-□□41-4A		16 mm	17 mm	19 mm	20 mm

Note: Combinations marked with parentheses should be avoided if possible.

Contact Numbers

Item	Mated diagram	Mounting holes (bottom view)
Plug, Straight Ter- minals		
Socket, Straight Ter- minals		

- Note:
- Contact numbers are not printed on the connectors. Use the triangular mark (▼) as a guide when designing and mounting to boards.
 - On the mating side, the row of terminals on the triangular mark side are called row a, and the row on the other side is called row b. The numbers are in the order shown.
 - The triangular marks on the plug and socket must be aligned when mated. The contact numbers on both sides must match.

Dimensions

■ XH3A - Plugs

Straight Through-hole Terminals

XH3A-□□41

(without PCB Fastening Pins)

XH3A-□□41-A

(with Fastening Pins)

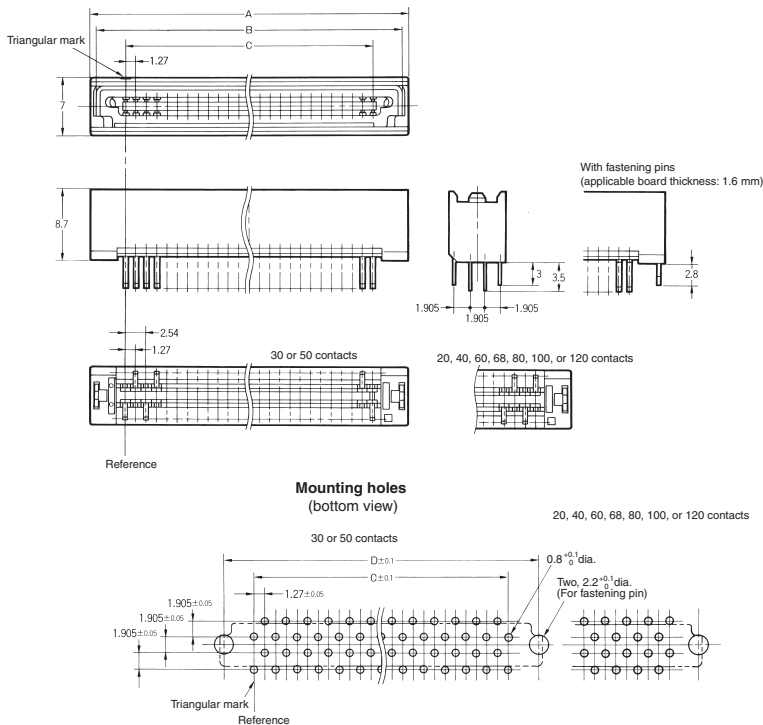
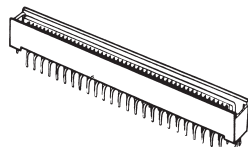

No. of contacts	Dimensions (mm)			
	A	B	C	D
20	20.0	18.7	11.43	18.54
30	26.4	25.1	17.78	24.89
40	32.7	31.4	24.13	31.24
50	39.1	37.8	30.48	37.59
60	45.4	44.1	36.83	43.94
68	50.5	49.2	41.91	49.02
80	58.1	56.8	49.53	56.64
100	70.8	69.5	62.23	69.34
120	83.5	82.2	74.93	82.04

Straight Through-hole Terminals, with Fastening Pin

Stacking Space Adjustable in Increments of 2 or 4 mm

XH3A-□□41-2A (2-mm Increments)

XH3A-□□41-4A (4-mm Increments)

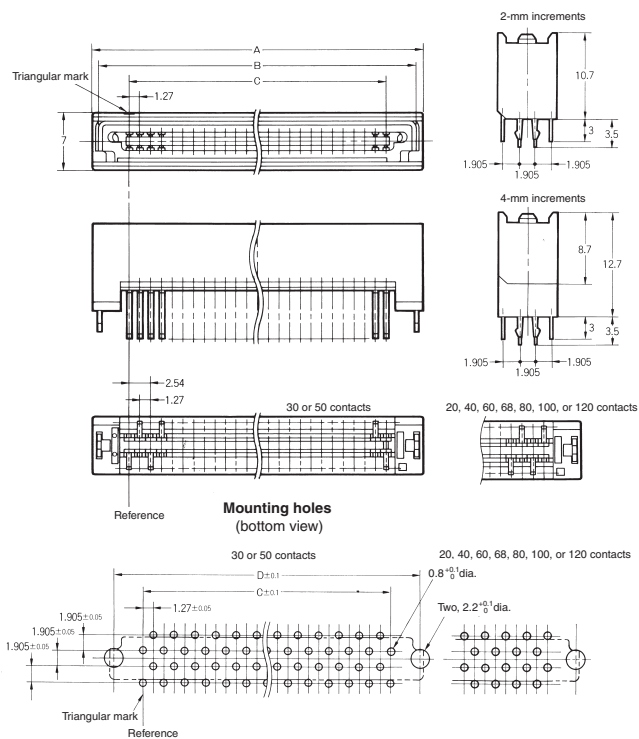
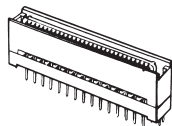

No. of contacts	Dimensions (mm)			
	A	B	C	D
20	20.0	18.7	11.43	18.54
30	26.4	25.1	17.78	24.89
40	32.7	31.4	24.13	31.24
50	39.1	37.8	30.48	37.59
60	45.4	44.1	36.83	43.94
68	50.5	49.2	41.91	49.02
80	58.1	56.8	49.53	56.64
100	70.8	69.5	62.23	69.34
120	83.5	82.2	74.93	82.04

Right-angle Through-hole Terminals, with Fastening Pin

XH3A-□□42-A

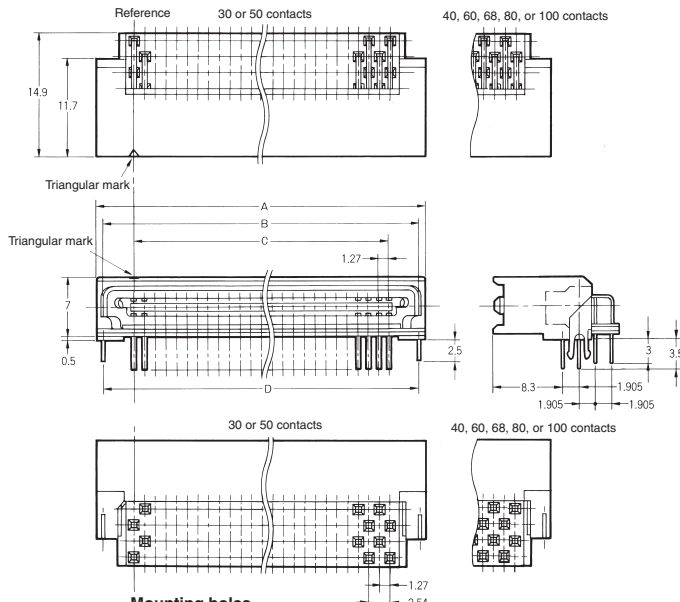
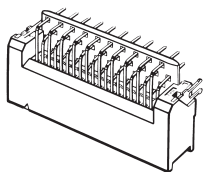

No. of contacts	Dimensions (mm)			
	A	B	C	D
30	26.4	25.1	17.78	24.89
40	32.7	31.4	24.13	31.24
50	39.1	37.8	30.48	37.59
60	45.4	44.1	36.83	43.94
68	50.5	49.2	41.91	49.02
80	58.1	56.8	49.53	56.64
100	70.8	69.5	62.23	69.34

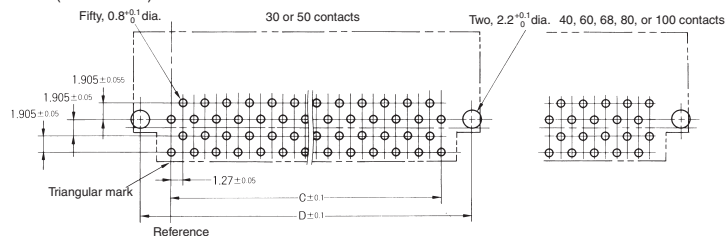

XH3B - Socket

Straight Through-hole Terminals

XH3B-□□41
(without Fastening Pins)

XH3B-□□41-A
(with Fastening Pins)

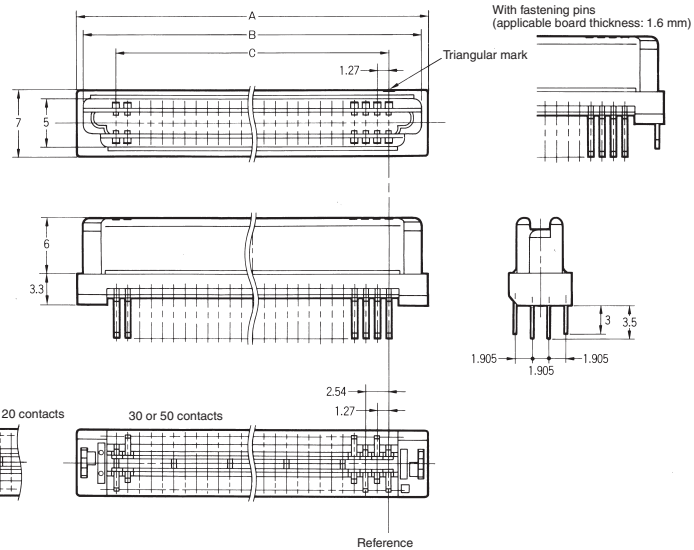
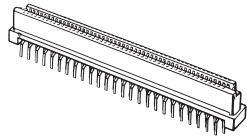

No. of contacts	Dimensions (mm)			
	A	B	C	D
20	20.0	18.6	11.43	18.54
30	26.4	25.0	17.78	24.89
40	32.7	31.3	24.13	31.24
50	39.1	37.7	30.48	37.59
60	45.4	44.0	36.83	43.94
68	50.5	49.1	41.91	49.02
80	58.1	56.7	49.53	56.64
100	70.8	69.4	62.23	69.34
120	83.5	82.1	74.93	82.04

20, 40, 60, 68, 80, 100, or 120 contacts

30 or 50 contacts

Mounting holes
(bottom view)

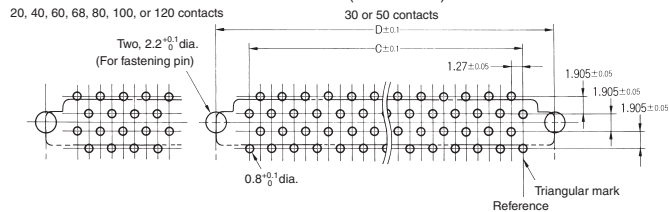

Straight Through-hole DIP Terminals, with Fastening Pin

Stacking Space Adjustable in Increments of 1, 3 or 4 mm

XH3B-□□41-1A (1-mm Increment)

XH3B-□□41-3A (3-mm Increments)

XH3B-□□41-4A (4-mm Increments)

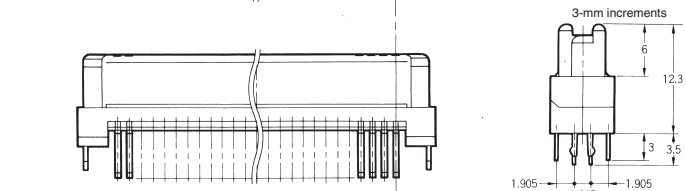
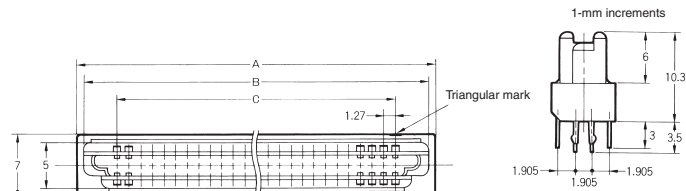
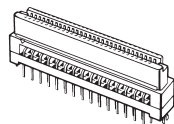

No. of contacts	Dimensions (mm)			
	A	B	C	D
20	20.0	18.6	11.43	18.54
30	26.4	25.0	17.78	24.89
40	32.7	31.3	24.13	31.24
50	39.1	37.7	30.48	37.59
60	45.4	44.0	36.83	43.94
68	50.5	49.1	41.91	49.02
80	58.1	56.7	49.53	56.64
100	70.8	69.4	62.23	69.34
120	83.5	82.1	74.93	82.04

20, 40, 60, 68, 80, 100, or 120 contacts

30 or 50 contacts

Mounting holes
(bottom view)

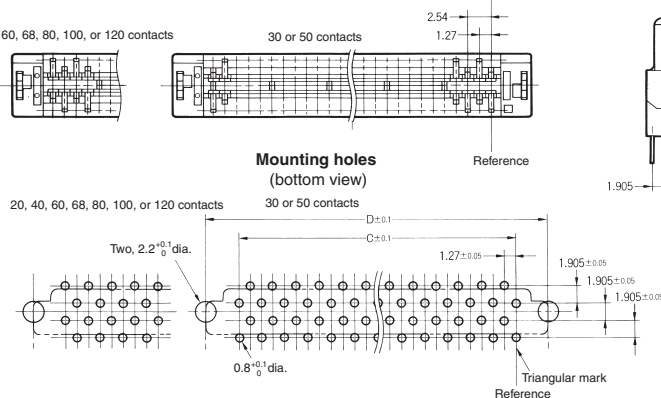

Right-angle Through-hole Terminals, with Fastening Pin

XH3B-□□42-A

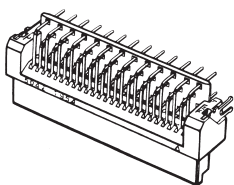

No. of contacts	Dimensions (mm)			
	A	B	C	D
30	26.4	25.0	17.78	24.89
40	32.7	31.3	24.13	31.24
50	39.1	37.7	30.48	37.59
60	45.4	44.0	36.83	43.94
68	50.5	49.1	41.91	49.02
80	58.1	56.7	49.53	56.64
100	70.8	69.4	62.23	69.34

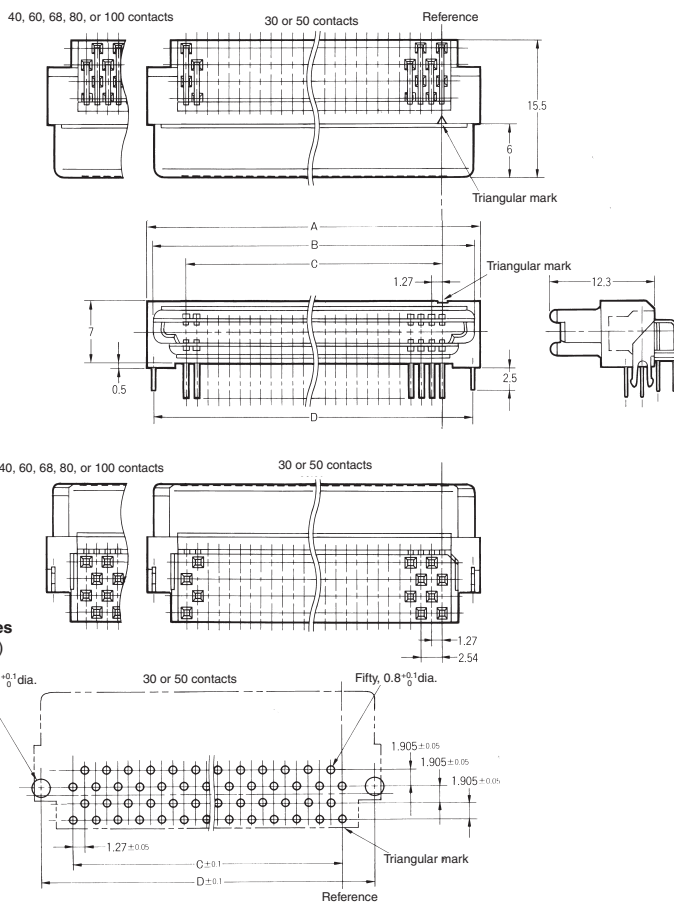

Precautions

Correct Use

Mating Compatibility

XH3 Half-pitch Connectors do not mate with XH2 or XH4 Half-pitch Connectors.

Special Finish for Preventing Flux Rise

XH3 Connectors (i.e., Straight Terminals and standard size, 1-, and 2-mm increments) have a special finish that prevents flux rise. (The Connectors are designed for automated soldering. Brush coating flux from the back of the board applies too much flux and may nullify the special finish. Never use this method to apply flux.)

Soldering

Automated soldering

Use tape to mask the Right-angle Terminal Connector prior to automated soldering.

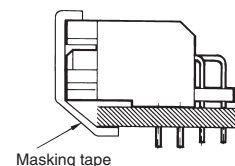

Automated Soldering Conditions (Jet Flow)

1. Soldering temperature: 250±5°C
2. Continuous soldering time: Within 5 s (Be sure to wash the board after continuous soldering is completed.)

All sales are subject to Omron Electronic Components LLC standard terms and conditions of sale, which can be found at http://www.components.omron.com/components/web/webfiles.nsf/sales_terms.html

ALL DIMENSIONS SHOWN ARE IN MILLIMETERS.
To convert millimeters into inches, multiply by 0.03937. To convert grams into ounces, multiply by 0.03527.

OMRON[®]

**OMRON ELECTRONIC
COMPONENTS LLC**

55 E. Commerce Drive, Suite B
Schaumburg, IL 60173

847-882-2288

OMRON ON-LINE

Global - <http://www.omron.com>

USA - <http://www.components.omron.com>