

Basic Switch

D2VW

Watertight Miniature Basic Switch

- High-quality watertight, high-precision miniature basic switch — meets IP67 requirements (IEC 529)
- Monoblock construction assures high sealing capability and is ideal for dusty places or where water is sprayed
- V-series internal mechanism assures high operating-position accuracy (± 0.4 mm) and long life (10 million operations)
- Wide operating temperature range of -40°C to 90°C is ideal for any operating environment
- General-load (5 A at 250 VAC) models and micro-load models are available

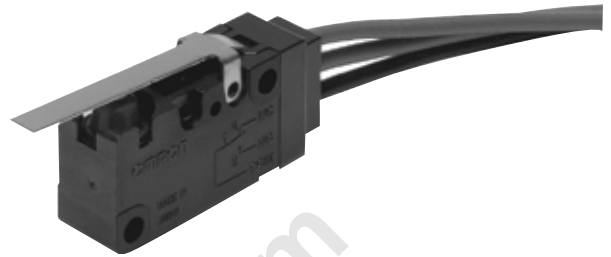

Ordering Information

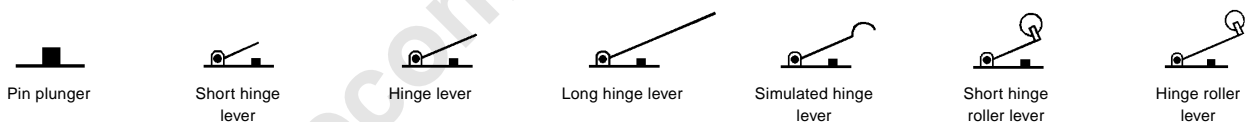

Actuator	Terminal	Part Number	
		Model 0.1 A	Model 5 A
Pin plunger	With solder and #187 tab terminals	D2VW-01-1HS	D2VW-5-1HS
	With lead wires	D2VW-01-1MS	D2VW-5-1MS
Short hinge lever	With solder and #187 tab terminals	D2VW-01L1A-1HS	D2VW-5L1A-1HS
	With lead wires	D2VW-01L1A-1MS	D2VW-5L1A-1MS
Hinge lever	With solder and #187 tab terminals	D2VW-01L1-1HS	D2VW-5L1-1HS
	With lead wires	D2VW-01L1-1MS	D2VW-5L1-1MS
Long hinge lever	With solder and #187 tab terminals	D2VW-01L1B-1HS	D2VW-5L1B-1HS
	With lead wires	D2VW-01L1B-1MS	D2VW-5L1B-1MS
Simulated hinge lever	With solder and #187 tab terminals	D2VW-01L3-1HS	D2VW-5L3-1HS
	With lead wires	D2VW-01L3-1MS	D2VW-5L3-1MS
Short hinge roller lever	With solder and #187 tab terminals	D2VW-01L2A-1HS	D2VW-5L2A-1HS
	With lead wires	D2VW-01L2A-1MS	D2VW-5L2A-1MS
Hinge roller lever	With solder and #187 tab terminals	D2VW-01L2-1HS	D2VW-5L2-1HS
	With lead wires	D2VW-01L2-1MS	D2VW-5L2-1MS

Note: The standard lengths of the lead wires (AWG20) of models incorporating them are 30 cm.

D2VW D2VW

CONTACT FORM

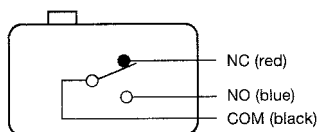

Specifications

D2VW-5

Rated Voltage	Non-inductive load				Inductive load			
	Resistive load		Lamp load		Inductive load		Motor load	
	NC	NO	NC	NO	NC	NO	NC	NO
125 VAC	5	—	0.5	—	4	—	—	—
250 VAC	5	—	0.5	—	4	—	—	—
30 VDC	5	—	3	—	4	—	—	—
125 VDC	0.4	—	0.1	—	0.4	—	—	—
250 VDC	0.2	—	0.03	—	0.2	—	—	—

D2VW-01

Rated Voltage	Non-inductive load				Inductive load			
	Resistive load		Lamp load		Inductive load		Motor load	
	NC	NO	NC	NO	NC	NO	NC	NO
125 VAC	0.1	—	—	—	—	—	—	—
30 VDC	0.1	—	—	—	—	—	—	—

- Note: 1. The above current ratings are the values of the steady-state current.
 2. Inductive load has a power factor of 0.7 min. (AC) and a time constant of 7 ms max. (DC).
 3. Lamp load has an inrush current of 10 times the steady-state current.
 4. Motor load has an inrush current of 6 times the steady-state current.

Characteristics

		D2VW-01	D2VW-5
Operating speed (see note 2)		0.1 mm to 1 m/s (at pin plunger)	
Operating frequency	Mechanical	300 operations/min.	
	Electrical	60 operations/min.	
Insulation resistance		100 MΩ min. (at 500 VDC)	
Contact resistance		100 mΩ max. (initial value)	
Dielectric strength		1,000 VAC, 50/60 Hz for 1 min. between contacts of the same polarity	
		1,500 VAC, 50/60 Hz for 1 min. between each terminal and ground	
Inrush current		—	15 A max.
Vibration resistance	Malfunction	10 to 55 Hz, 1.5 mm double amplitude	
Shock resistance	Malfunction	300 m/s ² (approx. 30 g)	
Life expectancy	Mechanical	10,000,000 operations min.	
	Electrical	1,000,000 operations min.	100,000 operations min
Ambient temperature	Operating	-40° to 90°C (with no icing)	
Ambient humidity	Operating	95% max.	
Enclosure rating		Reference to IP67 (IEC 529)	
Weight		16 g (including lead wire)	

- Note: 1. Data shown are of initial value.
 2. The operating speed value shown is for pin plunger models. For hinge lever models, contact OMRON.

D2VW **OMRON** D2VW

■ OPERATING CHARACTERISTICS

	Pin plunger	Short hinge lever	Hinge lever	Long hinge lever	Simulated hinge lever	Short hinge roller lever	Hinge roller lever
Type	D2VW-01-1HS D2VW-01-1MS D2VW-5-1HS D2VW-5-1MS	D2VW-01L1A-1HS D2VW-01L1A-1MS D2VW-5L1A-1HS D2VW-5L1A-1MS	D2VW-01L1-1HS D2VW-01L1-1MS D2VW-5L1-1HS D2VW-5L1-1MS	D2VW-01L1B-1HS D2VW-01L1B-1MS D2VW-5L1B-1HS D2VW-5L1B-1MS	D2VW-01L3-1HS D2VW-01L3-1MS D2VW-5L3-1HS D2VW-5L3-1MS	D2VW-01L2A-1HS D2VW-01L2A-1MS D2VW-5L2A-1HS D2VW-5L2A-1MS	D2VW-01L2-1HS D2VW-01L2-1MS D2VW-5L2-1HS D2VW-5L2-1MS
OF max.	200 g	200 g	120 g	60 g	120 g	230 g	120 g
RF min.	30 g	20 g	15 g	5 g	15 g	20 g	15 g
PT max.	1.2 mm	1.6 mm	4.0 mm	9.0 mm	4.0 mm	1.6 mm	4.0 mm
OT min.	1.0 mm	0.8 mm	1.6 mm	3.2 mm	1.6 mm	0.8 mm	1.6 mm
MD max.	0.4 mm	0.5 mm	0.8 mm	2.0 mm	0.8 mm	0.5 mm	0.8 mm
OP	14.7±0.4 mm	15.2±0.5 mm	15.2±1.2 mm	15.2±2.6 mm	18.7±1.2 mm	20.7±0.6 mm	20.7±1.2 mm

Dimensions

Unit: mm (inch)

Pin plunger
D2VW-01-1HS
D2VW-5-1HS

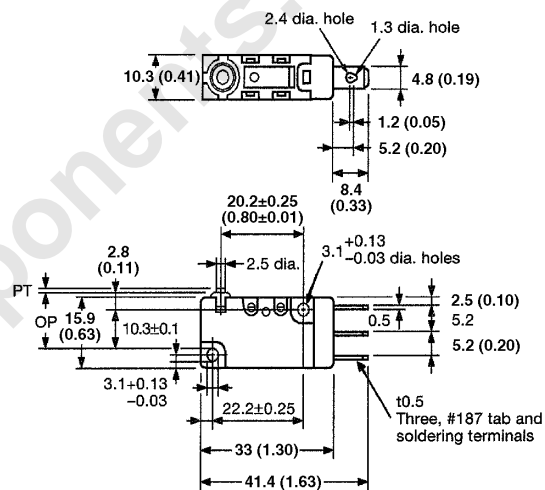
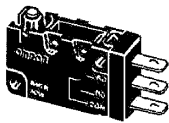

Pin plunger
D2VW-01-1MS
D2VW-5-1MS

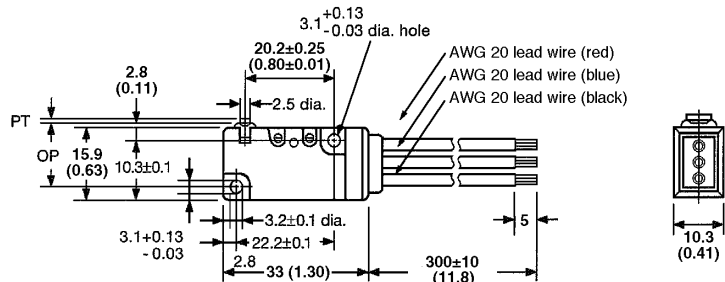
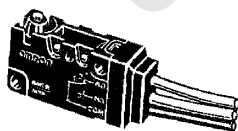

Short hinge lever
D2VW-01L1A-1MS
D2VW-5L1A-1MS

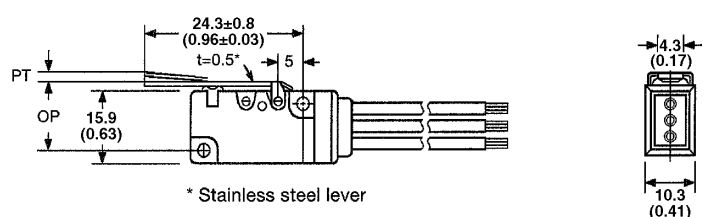
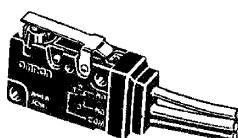

D2VW **OMRON** D2VW

Unit: mm (inch)

Hinge lever
D2VW-01L1-1MS
D2VW-5L1-1MS

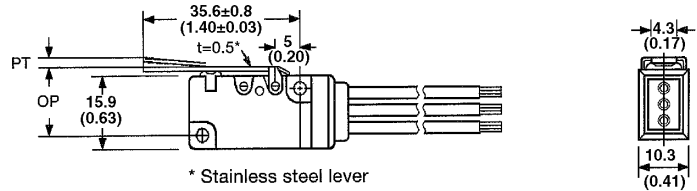
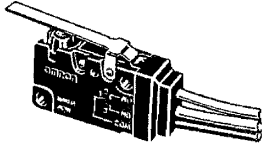

Long hinge lever
D2VW-01L1B-1MS
D2VW-5L1B-1MS

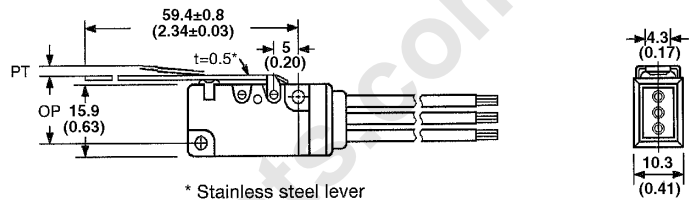
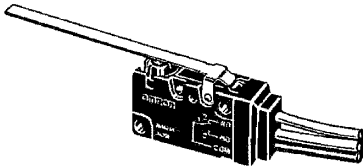

Simulated hinge lever
D2VW-01L3-1MS
D2VW-5L3-1MS

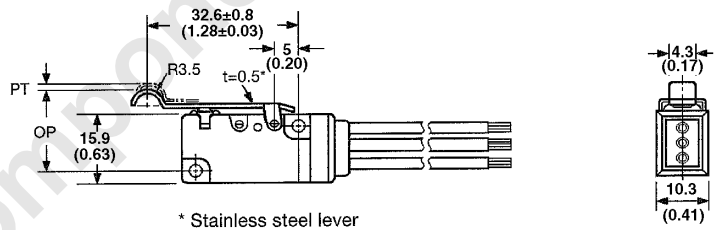
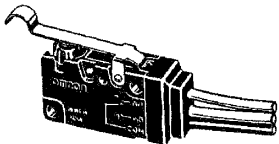

Short hinge roller lever
D2VW-01L2A-1MS
D2VW-5L2A-1MS

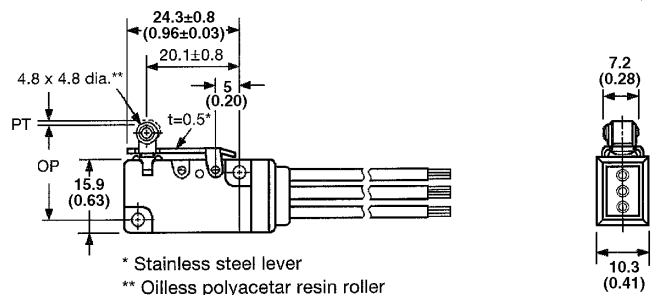
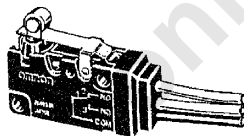

Hinge roller lever
D2VW-01L2-1MS
D2VW-5L2-1MS

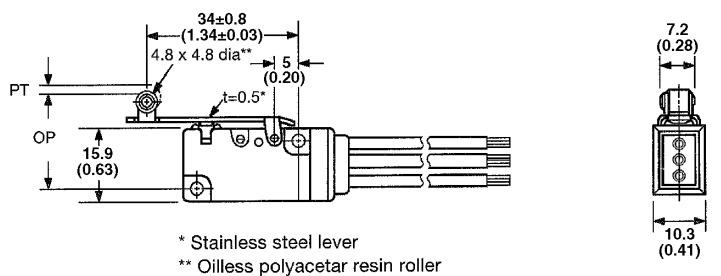
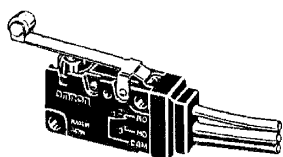

D2VW **OMRON** D2VW

■ APPROVALS

UL (File No. E41515)/CSA (File No. LR21642-388)

Precautions

■ MOUNTING

Use two M3 mounting screws with spring washers to mount the switch. Tighten the screws to a torque of 0.39 to 0.59 N • m (4 to 6 kgf • cm).

Mounting holes

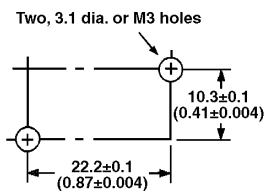

■ OPERATIONS

Make sure that the switching object is perfectly separated from the actuator when the switch is not operated and the actuator is pressed appropriately by the switching object when the switch is operated.

The switch should be set so that its stroke will be within the rated OT when the switch is operated.

Install the switching object so that its moving direction is the same as that of the actuator.

■ ENCLOSURE RATINGS

The D2VW was tested under water and passed the following watertightness test, which however, does not mean that the D2VW can be used in the water.

JIS C0929 (rules for testing the watertightness of electrical devices and materials), class 7 (watertightness test). Refer to the following illustration for the test method at OMRON.

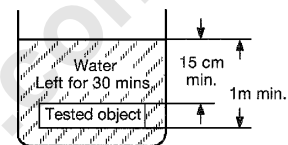

Note: The object to be tested is left in the water for 30 minutes on condition that the distance between the surface of the water and the top of the object be 15 cm minimum and the distance between the surface of the water and the bottom of the object be 1 m minimum.

OMRON

OMRON ELECTRONICS, INC.
One East Commerce Drive
Schaumburg, IL 60173
1-800-55-OMRON

OMRON CANADA, INC.
885 Milner Avenue
Scarborough, Ontario M1B 5V8
416-286-6465