

# Ultra Subminiature Basic Switch D2FS

## Simple Construction allows Continuous Actuation over time with High Reliability.

- Simple construction with a single-leaf movable spring and a reduced number of operations allows for high reliability in applications such as meter door anti-tampering circuits.
- Available in a variety of PCB terminals, including straight, self-clinching, right-angled and left-angled.
- RoHS Compliant.

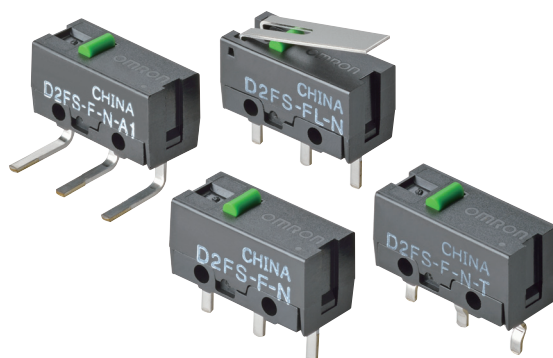

**NEW**

## Ordering Information

Actuator	Terminal type	Model
Pin plunger 	PCB terminals (Straight)	<b>D2FS-F-N</b>
	PCB terminals (Self-clinching)	<b>D2FS-F-N-T</b>
	PCB terminals (Right-angled)	<b>D2FS-F-N-A</b>
	PCB terminals (Left-angled)	<b>D2FS-F-N-A1</b>
Hinge lever 	PCB terminals (Straight)	<b>D2FS-FL-N</b>
	PCB terminals (Self-clinching)	<b>D2FS-FL-N-T</b>
	PCB terminals (Right-angled)	<b>D2FS-FL-N-A</b>
	PCB terminals (Left-angled)	<b>D2FS-FL-N-A1</b>

### Model Number Legend

D2FS-F<sup>1</sup>-N<sup>2</sup>

- 1. Actuator**  
 None: Pin plunger  
 L: Hinge lever

- 2. Terminals**  
 None: PCB terminals (Straight)  
 -T: PCB terminals (Self-clinching)  
 -A: PCB terminals (Right-angled)  
 -A1: PCB terminals (Left-angled)

# Specifications

## ■ Characteristics

Operating speed	Pin plunger models: 1 to 500 mm/second Lever models: 5 to 500 mm/second
Operating frequency	Mechanical: 200 operations per minute max. (Pin plunger models) 100 operations per minute max. (Lever models) Electrical: 30 operations per minute max.
Contact resistance	100 mΩ max.
Insulation resistance	100 MΩ min. at 500 VDC
Dielectric strength	600 VAC 50/60 Hz for 1 minute between terminals of the same polarity 1,500 VAC, 50/60 Hz for 1 minute between current-carrying metal parts and ground, and between each terminal and non-current-carrying metal parts
Vibration resistance (See note 2)	Malfunction: 10 to 55 Hz, 1.5 mm double amplitude
Shock resistance (See note 2)	Destruction: 1,000 m/s <sup>2</sup> (approx. 100G) max. Malfunction: 300 m/s <sup>2</sup> (approx. 30 g min.) max.
Degree of protection	IP40
Ambient operating temperature	-20° to 70°C (at 60% RH max.) with no icing or condensation
Ambient operating Humidity	85% max. (for 5° to 35°C)
Service life (Consult Omron for test conditions)	Mechanical: 100,000 operations min. at 30 operations/minute. Electrical: 10,000 operations min. at 30 operations/minute.
Weight	Approx. 0.5 g (pin plunger models)

Note: 1. Data shown are of initial value.

2. For pin plunger models, the values are measured at the free position and total travel position. For the lever models, they are measured at the total travel position. Contact opening or closing time is within 1 ms.

## ■ Ratings

Rated Voltage	Resistive load
6 VDC	0.1 A

Note: 1. When using an inductive load or motor load, consult OMRON.

2. The ratings apply under the following test conditions:  
Ambient Temperature = 20±2°C  
Ambient Humidity = 65±5%  
Operating frequency = 20 operations/min.

## ■ Contact Specifications

Specification	Crossbar
Material	Silver
Gap (Standard value)	0.4 mm
Minimum Applicable Load (See note)	1 mA at 5 VDC

Note: Minimum applicable loads are indicated by N standard reference values. This value represents the failure rate at a 60% ( $\lambda_{60}$ ) reliability level (JIS C5003).

The equation  $\lambda_{60}=0.5 \times 10^{-6}/\text{operations}$  indicates that a failure rate of 1/2,000,000 operations can be expected at a reliability level of 60%.

# Engineering Data

## ■ PCB Layout (reference)

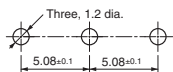

## ■ Structure

### Contact Form (SPST-NO)

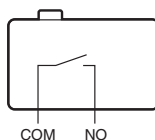

# Dimensions

## ■ Terminals

**Note:** Unless otherwise specified, all units are in millimeters and a tolerance of  $\pm 0.4$  mm applies to all dimensions

### PCB Terminals (Straight)

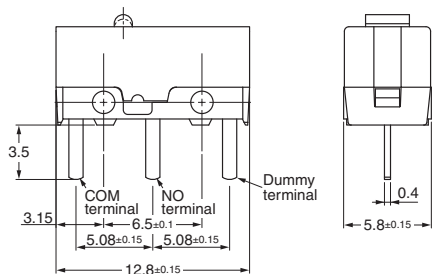

### PCB Terminals (Self-clinching)

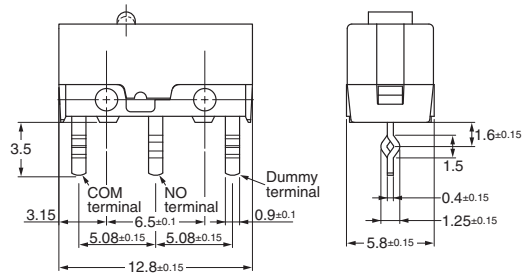

### PCB Terminals (Right-angled)

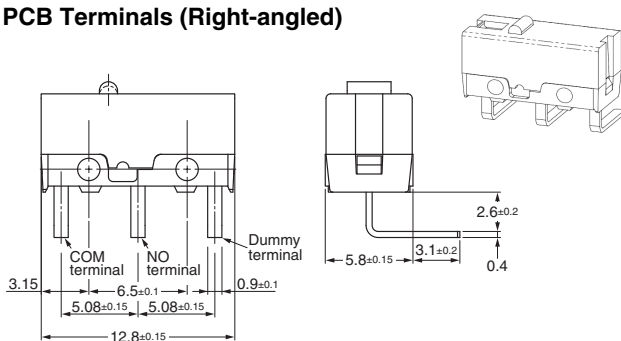

### PCB Terminals (Left-angled)

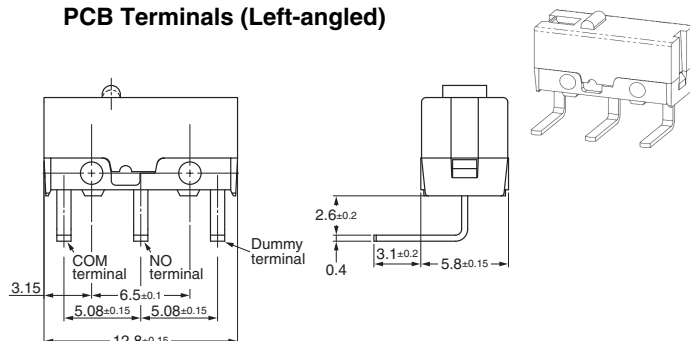

## ■ Dimensions and Operating Characteristics

**Note:** 1. Unless otherwise specified, all units are in millimeters and a tolerance of  $\pm 0.4$  mm applies to all dimensions

2. Omitted dimensions are the same as pin plunger type
3. The following illustrations and dimensions are for models with Straight PCB terminals. Refer to "Terminals" for models with other terminals.
4. The operating characteristics are for operation in the A direction(↓)

### Pin Plunger Models

D2FS-F-N□

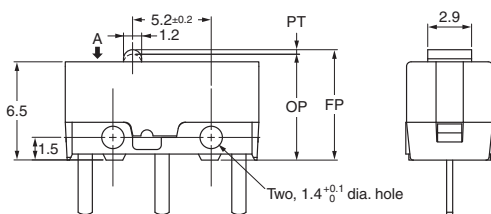

Characteristics	D2FS-F-N□
OF max.	87 gf
RF min.	5 gf
PT max.	0.5 mm
OT min.	0.25 mm
MD max.	0.12 mm
OP	7.0 ± 0.3 mm
FP max.	7.5 mm

### Hinge Lever Models

D2FS-FL-N□

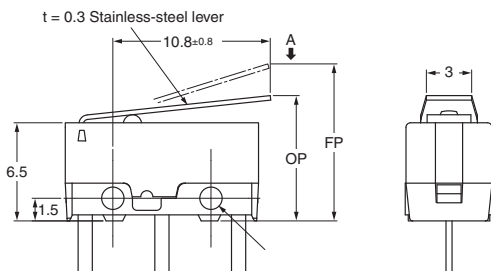
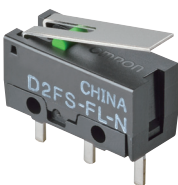

Characteristics	D2FS-FL-N□
OF max.	25 gf
RF min.	2 gf
PT max.	—
OT min.	0.55 mm
MD max.	0.5 mm
OP	8.3 ± 1.2 mm
FP max.	11.5 mm

# Precautions

Be sure to read the precautions and information common to all Snap Action and Detection Switches, contained in the Technical User's Guide, "Snap Action Switches, Technical Information" for correct use.

## ■ Cautions

### Application Environment

Do not use the switch in locations that are subject to toxic gas, silicon, excessive dust, excessive dirt, high temperatures, high humidity, sudden temperature changes, water splashes or oil splashes.

Otherwise, damage to the Switch contacts, corrosion or other functional damage may occur, resulting in faulty contact.

### Soldering

When using automatic soldering baths, we recommend soldering at 260 °C within 5 seconds. Make sure that the liquid surface of the solder does not flow over the edge of the board.

When soldering terminals manually, perform soldering within 3 seconds at iron tip temperature not higher than 350 °C. Do not apply any external force for at least 1 minute after soldering.

When applying solder, keep the solder away from the case of the Switch and do not allow solder or flux to flow into the case.

## ■ Correct Use

### Handling

When handling the switch, ensure that uneven pressure or, as shown in the following diagram, pressure in a direction other than the operating direction, is not applied to the actuator. Otherwise the actuator or switch may be damaged and life expectancy will be reduced.

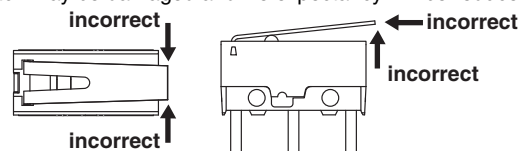

### Using Microloads

Even when using microload models within the operating range, if inrush current or inductive voltage spikes occur when the contact is opened or closed, it may increase contact wear and so decrease the service life. Therefore, insert a contact protection circuit where necessary.

### Side-actuated (Cam/Dog) Operation

When using a cam or dog to operate the Switch, factors such as the operating speed, operating frequency, push-button indentation, and material and shape of the cam or dog will affect the durability (life-expectancy) of the Switch. Confirm performance specifications under actual operating conditions before using the Switch in applications.

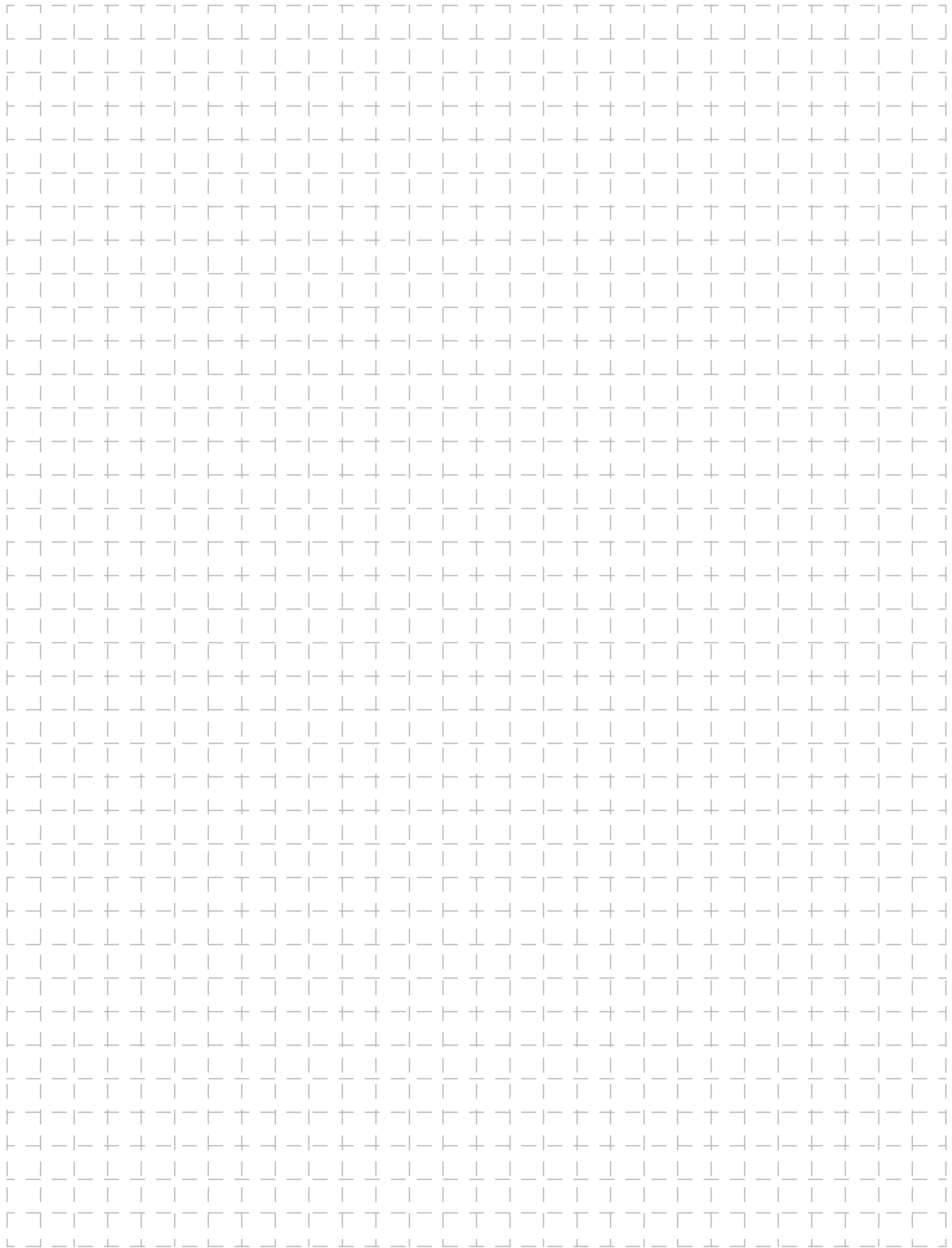

All sales are subject to Omron Electronic Components LLC standard terms and conditions of sale, which can be found at [http://www.components.omron.com/components/web/webfiles.nsf/sales\\_terms.html](http://www.components.omron.com/components/web/webfiles.nsf/sales_terms.html)

**ALL DIMENSIONS SHOWN ARE IN MILLIMETERS.**

To convert millimeters into inches, multiply by 0.03937. To convert grams into ounces, multiply by 0.03527.

**OMRON**<sup>®</sup>  
**OMRON ELECTRONIC  
COMPONENTS LLC**  
**847-882-2288**

Cat. No. B121-E-02

11/13

Specifications subject to change without notice

Printed in USA

**OMRON ON-LINE**

Global - <http://www.omron.com>

USA - <http://www.components.omron.com>