

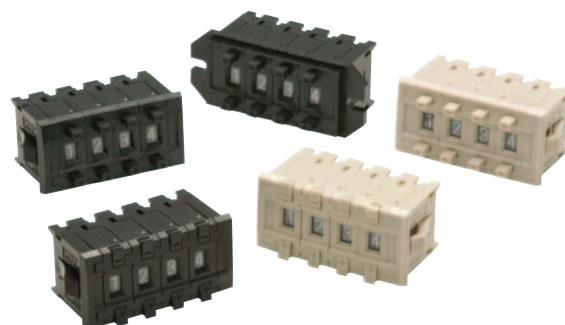

A Brand New Lineup of A7C Series Compact Thumbwheel Switches

- The series includes a complete range of locking-type models that prevent accidental operation.



Ordering Information

Switches (Single Switch Units)

Model		A7CN			
Classification (See note 1.)	Character height	Screw mounting (back mounting)		Snap-in (front mounting)	
					
Output code number	Terminals Color	3.4 mm PCB terminals			
06 (binary coded decimal)		Light gray	Black	Light gray	Black
			A7CN-106-1	A7CN-206	A7CN-206-1

Model		A7CN-L	
Classification (See note 1.)	Character height	Snap-in (front mounting)	
			
Output code number	Terminals Color	3.4 mm PCB terminals	
06 (binary coded decimal)		Light gray	Black
		A7CN-L206	A7CN-L206-1

- Note: 1. The classification diagrams show 4 Switch Units combined with End Caps to create 4-digit displays.
 2. The model numbers given above are for Switch Units.
 3. Models with +, - displays can also be produced. Add "-PM" after the "206" in the model number (e.g., A7CN-206-PM or A7CN-206-PM-1).

Accessories (Order Separately)

Use accessories, such as End Caps and Spacers, with the Switch Units.

Classification		Screw mounting (back mounting)	Snap-in (front mounting)	
Accessory	Color	Black	Light gray	Black
End Caps (1 pair)		A7CN-1M-1	A7CN-2M	A7CN-2M-1
Spacer		A7CN-1P□-1 (See note.)	A7CN-2P□ (See note.)	A7CN-2P□-1 (See note.)

Note: The □ in the Spacer model number stands for a letter in the range A to U. (Refer to the table in the following explanation about Spacers.)

End Caps

End Caps are used on the Switch Units at each end and allow all the Switch Units to be securely mounted to a panel. They come in pairs, one for the left and one for the right.

Spacers

- Spacers are used for creating extra space or gaps between the Switch Units and have the same dimensions as the Switch Units themselves.
- There are also Spacers with engraved characters or symbols that can be used for indicating units, such as time and length. (Refer to the following table.) Consult your OMRON representative for details.

Symbol	A	B	C	D	E	F	G
Stamp	No designation	SEC	MIN	H	g	kg	mm

Symbol	H	J	K	L	Q	T	U
Stamp	cm	m	°C	PCS	x10 SEC	0	•

Specifications

Switching capacity (resistive load)		5 to 28 VDC 1 mA to 0.1 A
Continuous carry current		1A
Contact resistance		200 mΩ max.
Insulation resistance	Between non-connected terminals	10 MΩ min. (at 250 VDC)
	Between terminal and non-current carrying part	100 MΩ min. (at 500 VDC)
Dielectric strength	Between non-connected terminals	200 VAC, 50/60 Hz for 1 min
	Between terminal and non-current carrying part	1,000 VAC, 50/60 Hz for 1 min
Vibration resistance		10 to 55 Hz, 1.5-mm double amplitude
Shock resistance		490m/s ² min.
Durability	Mechanical	30,000 operations min.
	Electrical	20,000 operations min.
Ambient temperature		Operating: -10°C to 65°C (with no icing) Storage: -20°C to 80°C
Ambient humidity		Operating: 35% to 85%
Max. operating force		4.41 N max.

Dimensions

Switches

A7CN-106-1 PCB Terminals

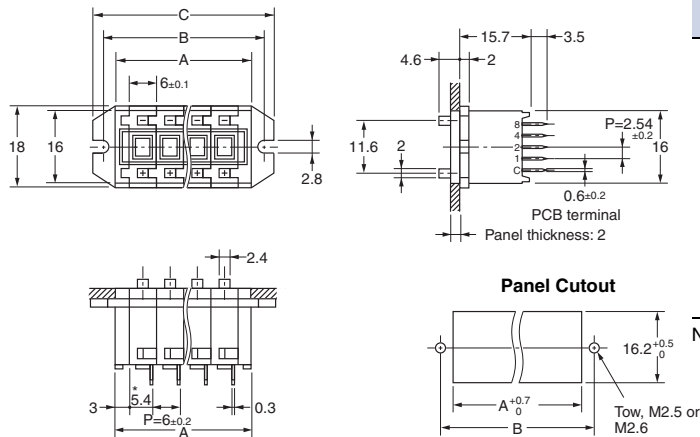

* Terminal position dimensions

Note: Common terminal C is at the bottom when the Switch Unit is viewed from the front.

Number of Switches (n)	Size A (n x 6 + 6)	Size B (n x 6 + 11)	Size C (n x 6 + 16)
1	12	17	22
2	18	23	28
3	24	29	34
4	30	35	40
5	36	41	46
6	42	47	52
7	48	53	58
8	54	59	64
9	60	65	70
10	66	71	76

Note: 1. The dimensions above include both End Caps, and will increase 6 mm for each Spacer inserted.
2. Unless otherwise specified, a tolerance of ±0.4 mm applies to all dimensions. The tolerance for multiple connection is ±(number of units x 0.4) mm.

A7CN-206(-1) PCB Terminals

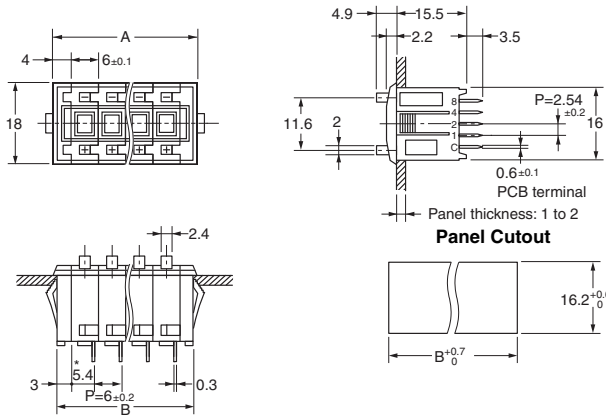
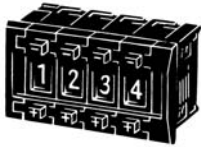

* Terminal position dimensions

Note: Common terminal C is at the bottom when the Switch Unit is viewed from the front.

Number of Switches (n)	Size A (n x 6 + 8)	Size B (n x 6 + 6)
1	14	12
2	20	18
3	26	24
4	32	30
5	38	36
6	44	42
7	50	48
8	56	54
9	62	60
10	68	66

Note: 1. The dimensions above include both End Caps, and will increase 6 mm for each Spacer inserted.
2. Unless otherwise specified, a tolerance of ±0.4 mm applies to all dimensions. The tolerance for multiple connection is ±(number of units x 0.4) mm.

A7CN-L206(-1) PCB Terminals Locking Model

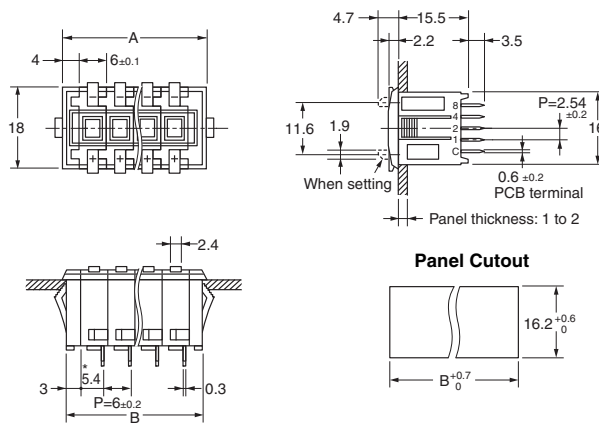

* Terminal position dimensions

Note: Common terminal C is at the bottom when the Switch Unit is viewed from the front.

Number of Switches (n)	Size A (n x 6 + 8)	Size B (n x 6 + 6)
1	14	12
2	20	18
3	26	24
4	32	30
5	38	36
6	44	42
7	50	48
8	56	54
9	62	60
10	68	66

Note: 1. The dimensions above include both End Caps, and will increase 6 mm for each Spacer inserted.
2. Unless otherwise specified, a tolerance of ±0.4 mm applies to all dimensions. The tolerance for multiple connection is ±(number of units x 0.4) mm.

Accessories (Order Separately)

End Caps for Push-operated Switches A7CN-1M-1 Screw Mounting

Left Side

Right Side

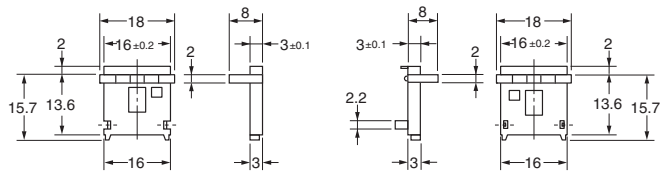

End Caps for Push-operated Switches A7CN-2M(-1) Snap-in Mounting

Left Side

Right Side

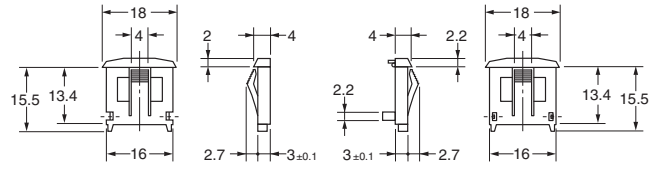

Spacers for Push-operated Switches A7CN-1P□-1

Screw Panel Mounting Model

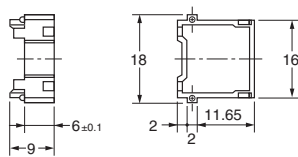

Note: The □ in the Spacer model number stands for a letter in the range A to U. (Refer to the table under the explanation about Spacers on page 3.)

Spacers for Push-operated Switches A7CN-2P□(-1)

Snap-in Mounting Model

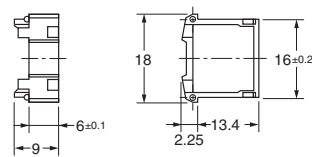

Note: The □ in the Spacer model number stands for a letter in the range A to U. (Refer to the table under the explanation about Spacers on page 3.)

Note: Unless otherwise indicated, dimensional tolerances for dimensions in the models above are ± 0.4 mm.

Output Codes

06 (Binary Code)

Dial	Terminals connected to common			
	1	2	4	8
0				
1	●			
2		●		
3	●	●		
4			●	
5	●		●	
6		●	●	
7	●	●	●	
8				●
9	●			●

Note: The solid dot ● indicates that the internal switch is ON (i.e., connected to the common terminal).

Ordering Procedure

Place orders as shown in the example below, specifying the model and number. Standard products are not factory-assembled for shipment. Contact your OMRON representative for details on ordering factory-assembled sets.

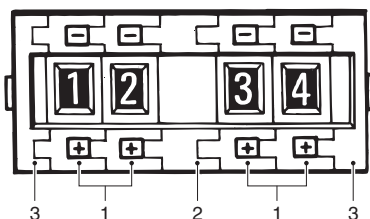

1. Switch Unit (snap-in mounting, black)
A7CN-206-1: 4 pieces
2. Spacer (snap-in mounting, no designation, black)
A7CN-2PA-1: 1 piece
3. End Caps (snap-in mounting, black)
A7CN-2M-1: 1 pair

Safety Precautions

Refer to *Precautions for Correct Use* on in the *Technical Guide for Thumbwheel Switches*.

Precautions for Correct Use

Environment

- Do not use where gases are generated (ammonia, chlorine, sulfur dioxide).
- Although Switches are of nearly dust-proof construction, they are not drip-proof, therefore do not use in areas subject to water or oil exposure and do not operate with wet or oily hands.
- Provide additional dust-proofing measures, such as using a dust-proof cover, when using in sand-exposed areas.

Handling

- The A7CN cannot be connected to the A7C.
- The molded components of the Switch use polyacetal resin and polycarbonate resin. It is recommended that alcohol is used to wipe off dirt and smudges from the molded components. Take care to prevent the alcohol from getting inside. Do not use thinner or other solutions which might damage the resin.
- When changing settings, do not touch the operating buttons if your fingers are wet or there is oil or any other foreign substance on your fingers.
- Do not drop the individual Switches. Doing so may damage the resin catch (for connecting) on the side of the Switch.
- When separating Switches, use a screwdriver as shown in the figure below; disconnect them by releasing the top and bottom hooks. Be careful not to bend the hooks.

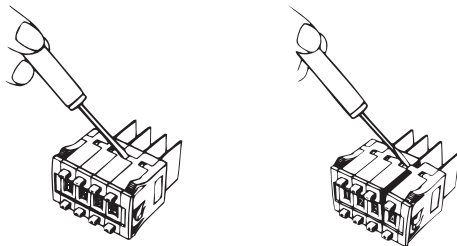

- When connecting Switches, fit the mating parts together.
- Do not push the (+) and (-) operating push-buttons at the same time.

Models with PCB Terminals

Do not use excessive force in handling the Switches. In particular, take care to avoid dropping them because the terminals might bend or break.

Screw-mounting Models

Tighten mounting screws to a torque between 0.2 to 0.24 N·m, using M2.6 screws. Use plain washers or spring washers together with the screws.

Setting Numbers

Locking Type

- Set with the setting button by raising it.
- Return the button to its original position after setting. It is then locked to prevent rotation, and the set numbers will not change accidentally.

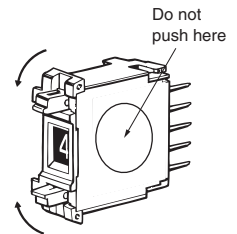

Soldering

Note the following points when soldering printed circuit boards:

- The terminal insertion holes on the PCB must be at least 1 mm in diameter.
- Automatic Soldering
 - Do not use dip cleaning. Doing so may result in flux penetration of the Switch interior, causing contact and rotational defects. Clean the flux as shown in Figure 1, tilting the Switch 80° or less and using a brush to apply the solvent only to the back of the board. It may also be cleaned by dipping only the back of the board into the solvent and then using a brush to clean.
- Dip Soldering
 - When applying flux solvent, the dipping time is a maximum of 2 seconds. As shown in Figure 2, avoid flooding the top surface of the printed circuit board with flux. Using a brush to apply flux further reduces the danger of flux penetration. When cleaning flux with a brush, tilt the Switch 80° or less, as shown in Figure 1, in order to prevent flux from flowing onto the switch mounting surface. Clean flux as described above under Automatic Soldering.

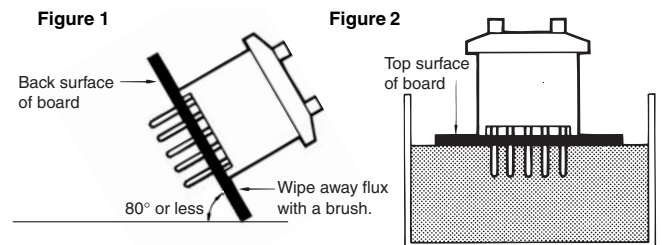

- Using a Soldering Iron
 - Use a 30-W soldering iron at a temperature of 350°C for a maximum of 3 seconds, and flush as described above. Do not apply force to the terminals during soldering and for 3 minutes after soldering is completed. Doing so may result in conduction or operation failure.
- Ensure that soldering flux and alcohol do not penetrate into the Switch interior

Terms and Conditions Agreement

Read and understand this catalog.

Please read and understand this catalog before purchasing the products. Please consult your OMRON representative if you have any questions or comments.

Warranties.

(a) Exclusive Warranty. Omron's exclusive warranty is that the Products will be free from defects in materials and workmanship for a period of twelve months from the date of sale by Omron (or such other period expressed in writing by Omron). Omron disclaims all other warranties, express or implied.

(b) Limitations. OMRON MAKES NO WARRANTY OR REPRESENTATION, EXPRESS OR IMPLIED, ABOUT NON-INFRINGEMENT, MERCHANTABILITY OR FITNESS FOR A PARTICULAR PURPOSE OF THE PRODUCTS. BUYER ACKNOWLEDGES THAT IT ALONE HAS DETERMINED THAT THE PRODUCTS WILL SUITABLY MEET THE REQUIREMENTS OF THEIR INTENDED USE.

Omron further disclaims all warranties and responsibility of any type for claims or expenses based on infringement by the Products or otherwise of any intellectual property right. (c) Buyer Remedy. Omron's sole obligation hereunder shall be, at Omron's election, to (i) replace (in the form originally shipped with Buyer responsible for labor charges for removal or replacement thereof) the non-complying Product, (ii) repair the non-complying Product, or (iii) repay or credit Buyer an amount equal to the purchase price of the non-complying Product; provided that in no event shall Omron be responsible for warranty, repair, indemnity or any other claims or expenses regarding the Products unless Omron's analysis confirms that the Products were properly handled, stored, installed and maintained and not subject to contamination, abuse, misuse or inappropriate modification. Return of any Products by Buyer must be approved in writing by Omron before shipment. Omron Companies shall not be liable for the suitability or unsuitability or the results from the use of Products in combination with any electrical or electronic components, circuits, system assemblies or any other materials or substances or environments. Any advice, recommendations or information given orally or in writing, are not to be construed as an amendment or addition to the above warranty.

See <http://www.omron.com/global/> or contact your Omron representative for published information.

Limitation on Liability; Etc.

OMRON COMPANIES SHALL NOT BE LIABLE FOR SPECIAL, INDIRECT, INCIDENTAL, OR CONSEQUENTIAL DAMAGES, LOSS OF PROFITS OR PRODUCTION OR COMMERCIAL LOSS IN ANY WAY CONNECTED WITH THE PRODUCTS, WHETHER SUCH CLAIM IS BASED IN CONTRACT, WARRANTY, NEGLIGENCE OR STRICT LIABILITY.

Further, in no event shall liability of Omron Companies exceed the individual price of the Product on which liability is asserted.

Suitability of Use.

Omron Companies shall not be responsible for conformity with any standards, codes or regulations which apply to the combination of the Product in the Buyer's application or use of the Product. At Buyer's request, Omron will provide applicable third party certification documents identifying ratings and limitations of use which apply to the Product. This information by itself is not sufficient for a complete determination of the suitability of the Product in combination with the end product, machine, system, or other application or use. Buyer shall be solely responsible for determining appropriateness of the particular Product with respect to Buyer's application, product or system. Buyer shall take application responsibility in all cases.

NEVER USE THE PRODUCT FOR AN APPLICATION INVOLVING SERIOUS RISK TO LIFE OR PROPERTY OR IN LARGE QUANTITIES WITHOUT ENSURING THAT THE SYSTEM AS A WHOLE HAS BEEN DESIGNED TO ADDRESS THE RISKS, AND THAT THE OMRON PRODUCT(S) IS PROPERLY RATED AND INSTALLED FOR THE INTENDED USE WITHIN THE OVERALL EQUIPMENT OR SYSTEM.

Programmable Products.

Omron Companies shall not be responsible for the user's programming of a programmable Product, or any consequence thereof.

Performance Data.

Data presented in Omron Company websites, catalogs and other materials is provided as a guide for the user in determining suitability and does not constitute a warranty. It may represent the result of Omron's test conditions, and the user must correlate it to actual application requirements. Actual performance is subject to the Omron's Warranty and Limitations of Liability.

Change in Specifications.

Product specifications and accessories may be changed at any time based on improvements and other reasons. It is our practice to change part numbers when published ratings or features are changed, or when significant construction changes are made. However, some specifications of the Product may be changed without any notice. When in doubt, special part numbers may be assigned to fix or establish key specifications for your application. Please consult with your Omron's representative at any time to confirm actual specifications of purchased Product.

Errors and Omissions.

Information presented by Omron Companies has been checked and is believed to be accurate; however, no responsibility is assumed for clerical, typographical or proofreading errors or omissions.

2014.5

In the interest of product improvement, specifications are subject to change without notice.

OMRON Corporation
Industrial Automation Company

<http://www.ia.omron.com/>

(c)Copyright OMRON Corporation 2014 All Right Reserved.