

## HEADPHONE AMPLIFIER for CD-ROM

### GENERAL DESCRIPTION

The **NJM2769B** is a headphone amplifier designed for CD-ROM.

It includes 6dB closed loop gain and mute circuit, requires few external component.

The **NJM2769B** realizes very low turn-noise at mute mode. It is suitable for CD-ROM, and other general audio headphone amplifier application.

### PACKAGE OUTLINE



**NJM2769BM**  
(DMP8)



**NJM2769BRB1**  
MSOP8(TVSP8)

### FEATURES

- Operating Voltage                    2.8 to 5.5V
- Operating Current                    2mA typ. at  $V^+ = 5V$
- Fixed Gain                            6dB typ.
- Stereo Headphone Output
- Internal Mute Circuit
- Bipolar Technology
- Package Outline

DMP8  
MSOP8(TVSP8)\*

\*MEET JEDEC MO-187-DA / THIN TYPE

### PIN CONFIGURATION

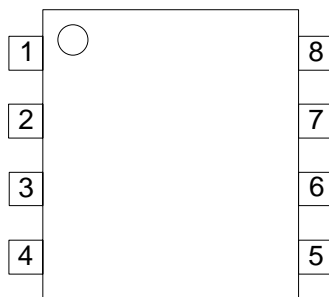

#### PIN FUNCTION

- 1.OUT1
- 2.MUTE
- 3.IN1
- 4.GND
- 5.IN2
- 6.BIAS
- 7.OUT2
- 8. $V^+$

### BLOCK DIAGRAM

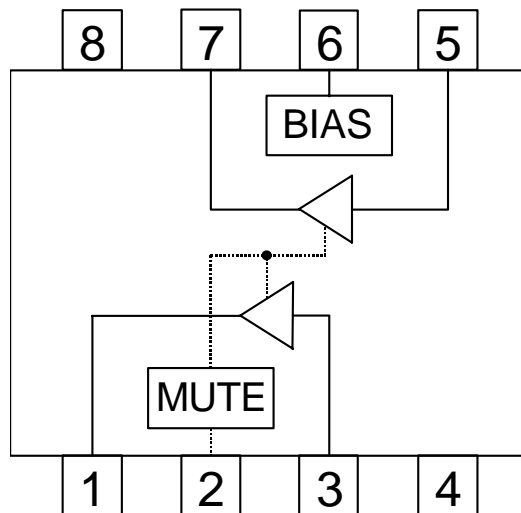

# NJM2769B

## ■ ABSOLUTE MAXIMUM RATINGS (Ta=25°C)

PARAMETER	SYMBOL	RATINGS	UNIT
Supply Voltage	V <sup>+</sup>	+7	V
Power Dissipation	P <sub>D</sub>	(DMP8) 375 750 (note) (MSOP8(TVSP8))320	mW
Operating Temperature Range	Topr	-40 to +85	°C
Storage Temperature Range	Tstg	-50 to +150	°C

(note) At on PC board

## ■ ELECTRICAL CHARACTERISTICS (V<sup>+</sup>=5.0V, Vin=-6dBV, f=1kHz, R<sub>L</sub>=32Ω, Ta=25°C unless otherwise specified)

PARAMETER	SYMBOL	TEST CONDITIONS	MIN.	TYP.	MAX.	UNIT
Operating Voltage	V <sup>+</sup>		2.8	5.0	5.5	V
Operating Current	I <sub>CC</sub>	No Signal	-	2.0	4.0	mA
Reference Voltage	V <sub>ref</sub>	No Signal	-	2.1	-	V
Closed Loop Gain	G <sub>v</sub>		5	6	7	dB
Channel Balance	ΔG <sub>v</sub>		-0.5	0	+0.5	dB
Output Power	P <sub>O1</sub>	R <sub>L</sub> =32Ω, THD=0.1%	30	50	-	mW
	P <sub>O2</sub>	R <sub>L</sub> =16Ω, THD=0.1%	40	100	-	mW
Total Harmonic Distortion	THD		-	0.02	0.1	%
Output Noise Voltage	V <sub>no</sub>	R <sub>g</sub> =0Ω, A-Weighted	-	-98 (12.6)	-88 (39.8)	dBV (μV <sub>rms</sub> )
Mute Attenuation	ATT	V <sub>o</sub> /V <sub>in</sub>	-	-80	-70	dB
Channel Separation	CS		65	80	-	dB
Ripple Rejection Ratio	RR	V <sub>ripple</sub> =-20dBV, R <sub>g</sub> =0Ω	-	65	-	dB
Input Voltage H-level	V <sub>IH</sub>		2.0	-	V <sup>+</sup>	V
Input Voltage L-level	V <sub>IL</sub>		0.0	-	0.3	V

## ■ CONTROL PIN INFORMATION

PARAMETER	CONTROL SIGNAL	OPERATING CONDITION
MUTE ON	L	NON-SIGNAL
MUTE OFF	H	OUTPUT SIGNAL

## ■ TERMINAL DESCRIPTION

PIN NO.	SYMBOL	FUNCTION	EQUIVALENT CIRCUIT	TERMINAL VOLTAGE
1 7	OUT1 OUT2	OUTPUT1 OUTPUT2		$(V^+ - 1V_{BE})/2$
2	MUTE	MUTE CONTROL		-
3 5	IN1 IN2	INPUT1 INPUT2		$(V^+ - 1V_{BE})/2$
6	BIAS	REFERENCE VOLTAGE STABILIZED CAPACITOR CONNECT TERMINAL		$(V^+ - 1V_{BE})/2$

# NJM2769B

## ■ TYPICAL APPLICATION

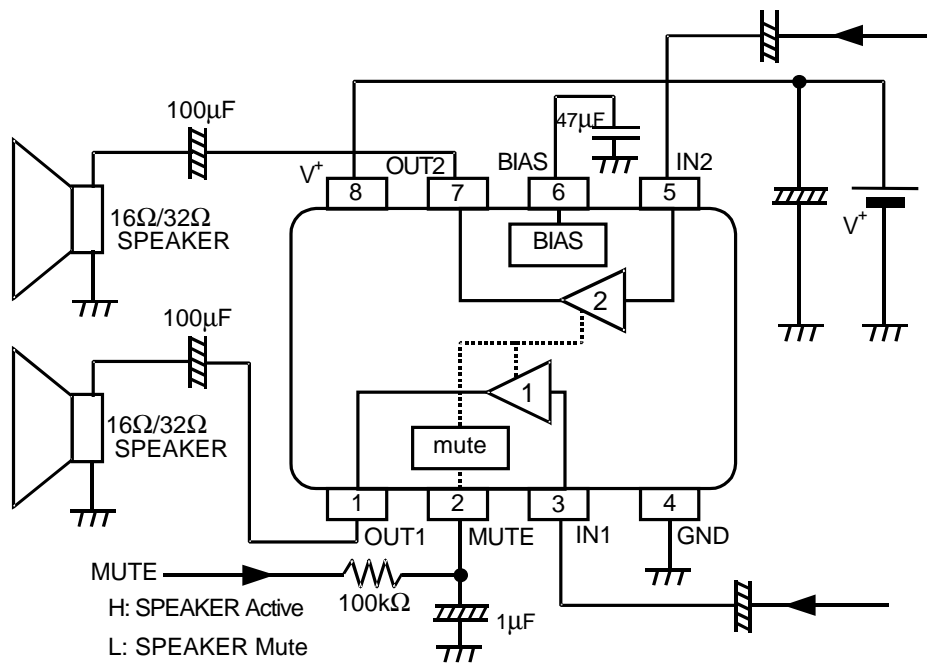

## ■ TYPICAL CHARACTERISTICS

Operating Current vs. Operating Voltage  
(MUTE=V+)

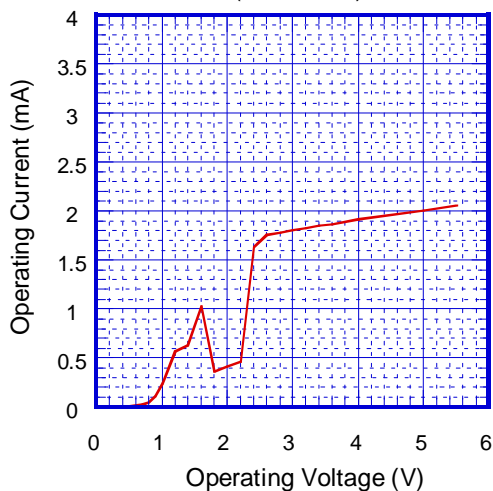

Operating Current vs. Ambient Temperature

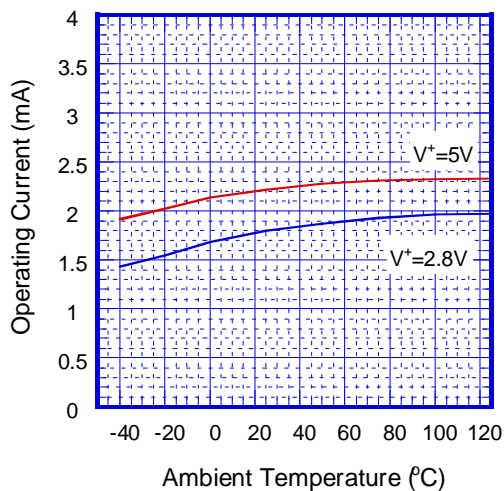

Reference Voltage vs. Operating Voltage

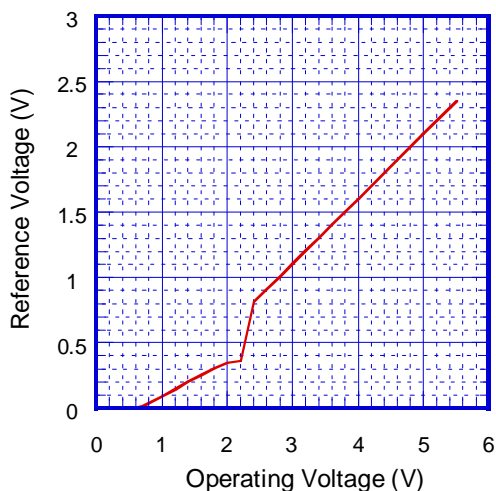

Reference Voltage vs. Ambient Temperature

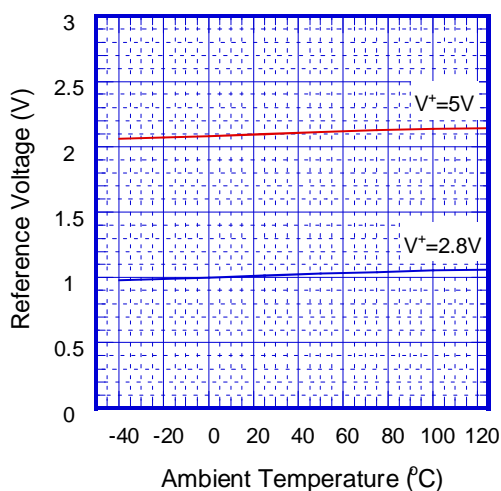

Power Dissipation vs. Output Power  
(V+=5V, f=1KHz)

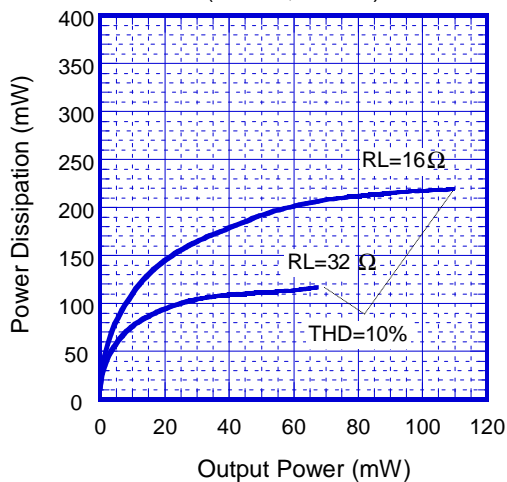

Power Dissipation vs. Output Power  
(V+=2.8V, f=1KHz)

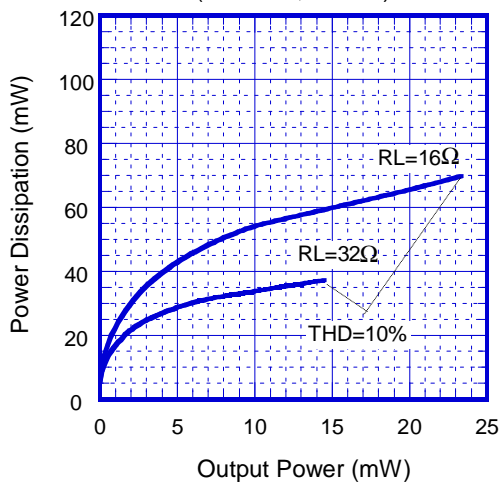

# NJM2769B

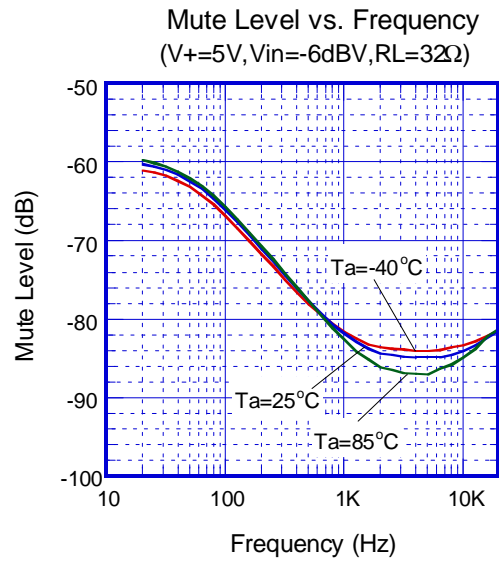
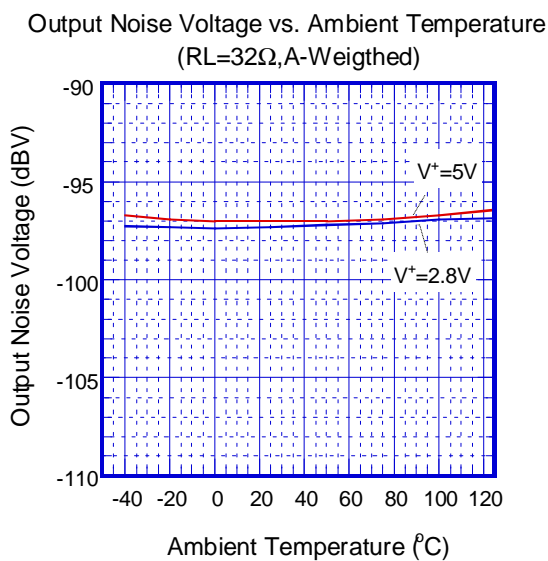
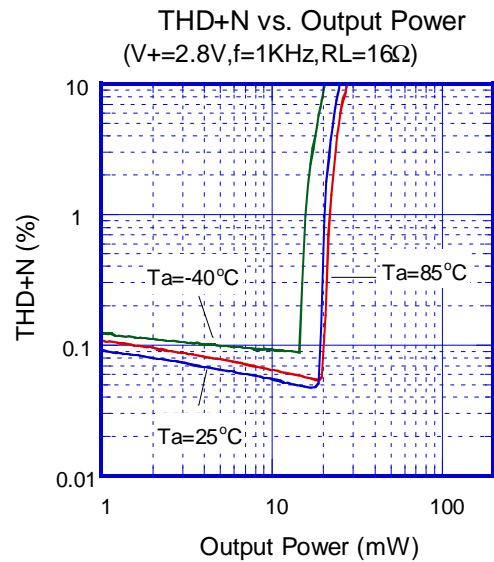
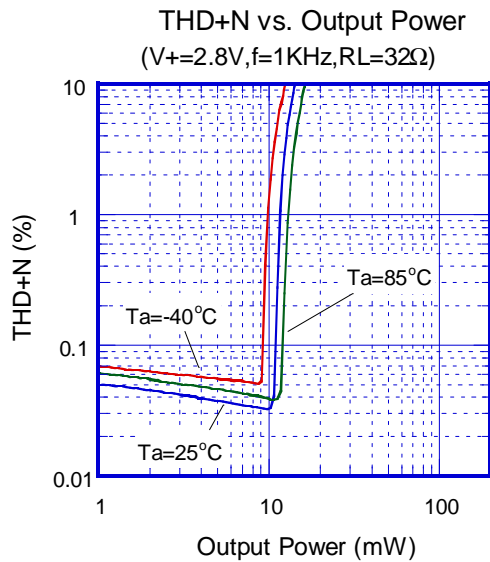
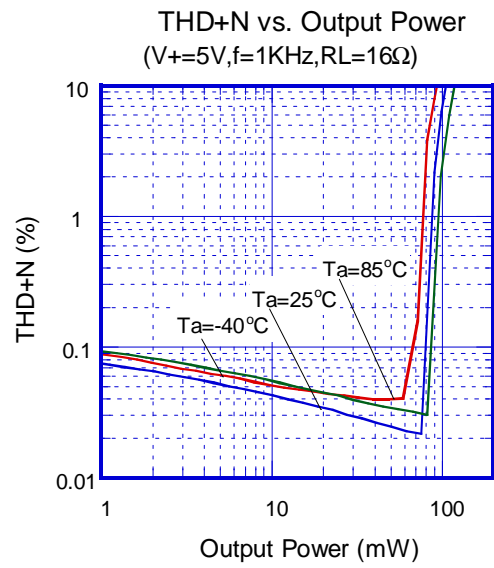
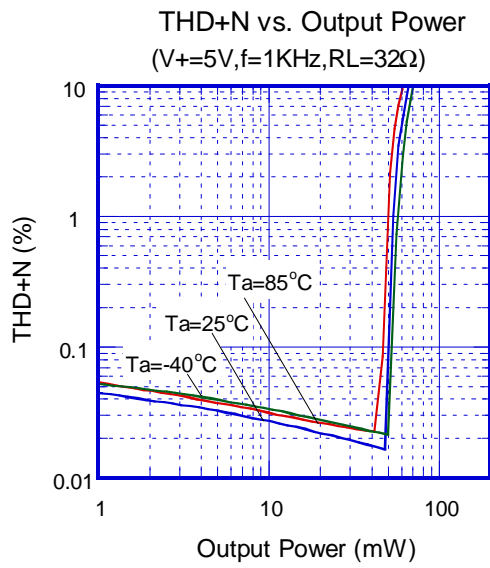

Channel Separation vs. Frequency  
( $V_+ = 5V, f = 1KHz, R_L = 32\Omega$ )

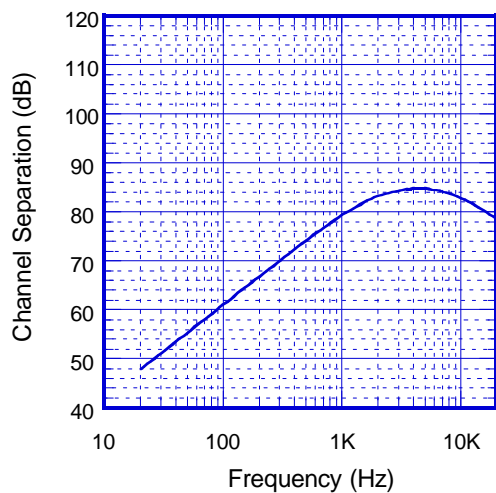

Ripple Rejection Ratio vs. Frequency  
( $V_{ripple} = -20dBV, R_L = 32\Omega$ )

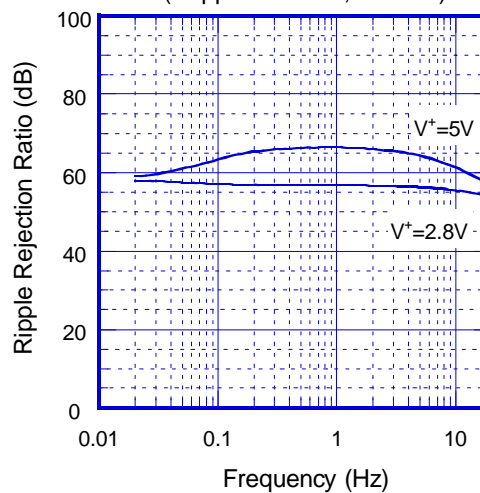

Voltage Gain vs Mute Control Voltage  
( $V_+ = 5V, f = 1KHz, V_{in} = -6dBV$ )

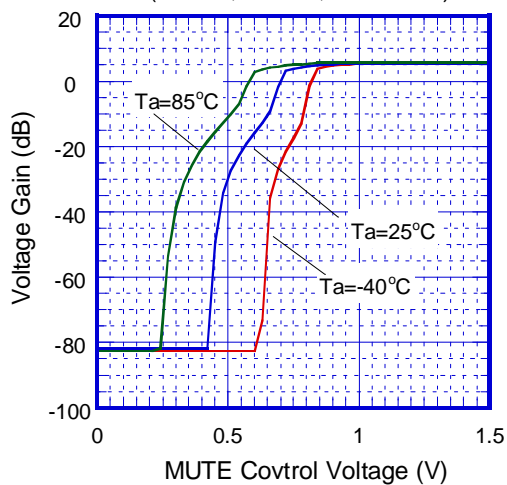

**[CAUTION]**

The specifications on this databook are only given for information, without any guarantee as regards either mistakes or omissions. The application circuits in this databook are described only to show representative usages of the product and not intended for the guarantee or permission of any right including the industrial rights.