

**EP2F/EP1F SERIES****HIGH HEAT RESISTIVITY****DESCRIPTION**

The NEC TOKIN EP2F / EP1F series are PC-board mount type automotive relays suitable for various motor controls and other applications that require a high level of quality and performance.

The operate temperature range for EP2F / EP1F series is  $-40^{\circ}\text{C}$  through  $+125^{\circ}\text{C}$ .

By this high heat resistivity, the contact carrying current of EP2F / EP1F series at  $25^{\circ}\text{C}$  increases 1.3 or 1.4 times compared with that of EP2 / EP1 series.

**FEATURES**

- Operating ambient temperature up to  $+125^{\circ}\text{C}$  (EP2 / EP1 :  $+85^{\circ}\text{C}$ )
- Suitable for motor and solenoid reversible control
- High performance and productivity by unique structure
- Flux tight housing

**APPLICATIONS**

- Power window control
- Power sunroof
- Wiper system

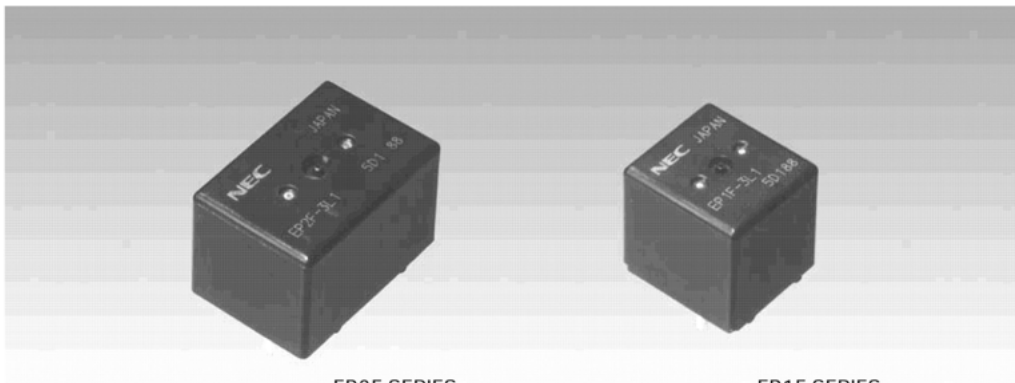

Date Published December 2005 NOHP02  
Printed in Japan

© NEC TOKIN Corporation 2005



- All specifications in this catalog and production status of products are subject to change without notice. Prior to the purchase, please contact NEC Tokin for updated product data.
- Please request for a specification sheet for detailed product data prior to the purchase.
- Before using the product in this catalog, please read "Precautions" and other safety precautions listed in the printed version catalog.

SCHEMATIC (BOTTOM VIEW)

EP2F SERIES

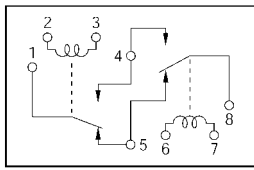

[Unit A] [Unit B]  
[H Bridge Type]

EP1F SERIES

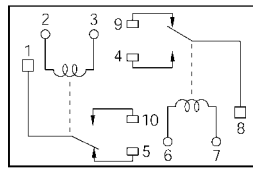

[Unit A] [Unit B]  
[Separate Type]

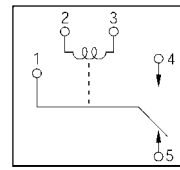

DIMENSIONS mm (inch)

EP2F SERIES

H Bridge Type

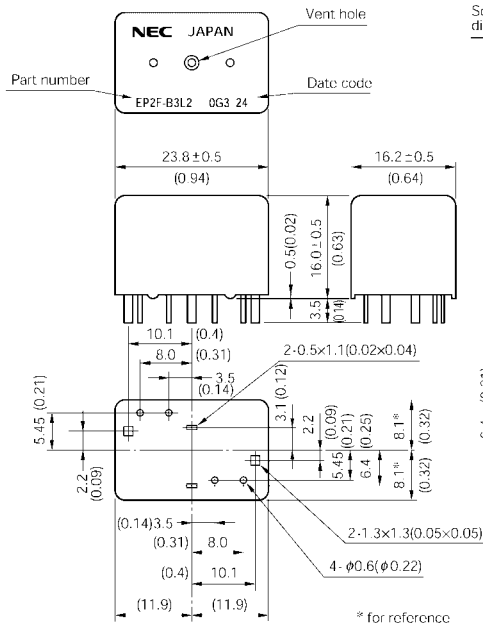

Separate Type

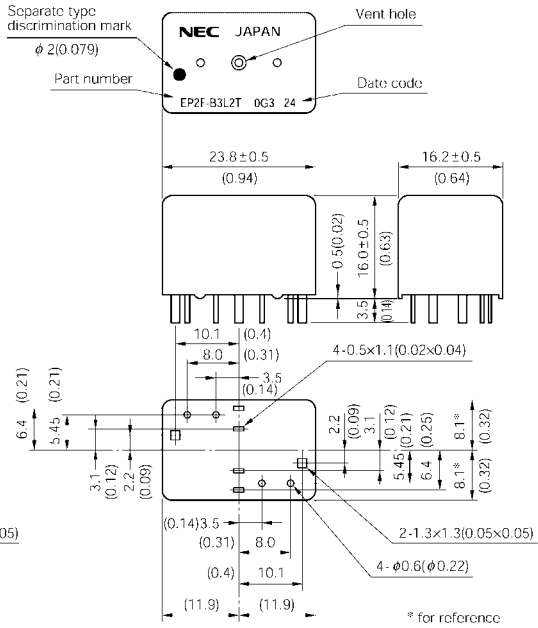

- All specifications in this catalog and production status of products are subject to change without notice. Prior to the purchase, please contact NEC Tokin for updated product data.
- Please request for a specification sheet for detailed product data prior to the purchase.
- Before using the product in this catalog, please read "Precautions" and other safety precautions listed in the printed version catalog.



## SPECIFICATIONS

at 25 °C (77 °F)

Items	EP2F	EP1F	
Contact Form	1 Form c × 2 (H bridge type and separate type)	1 Form c	
Contact Material	Silver oxide complex alloy		
Contact Resistance	50 mΩ max. (measured at 7 A) initial		
Contact Switching Voltage	16 Vdc max.		
Contact Switching Current	25 A Max.		
Contact Carrying Current	35 A (2 minutes max. 12 Vdc at 25°C) 30 A (2 minutes max. 12 Vdc at 85°C) 25 A (2 minutes max. 12 Vdc at 125°C)	40 A (2 minutes max. 12 Vdc at 25°C) 35 A (2 minutes max. 12 Vdc at 85°C) 30 A (2 minutes max. 12 Vdc at 125°C)	
Operate Time	Approx. 5 ms (at 12 Vdc excluding bounce) initial		
Release Time	Approx. 2 ms (at 12 Vdc excluding bounce) initial		
Normal Operate Power	0.64 W (at 12 Vdc)		
Insulation Resistance	100 MΩ min. (at 500 Vdc) initial		
Breakdown Voltage	500 Vdc min. (for 1 minute) initial		
Shock Resistance	98 m / s <sup>2</sup> [Approx. 10 G] min. (misoperating)		
Vibration Resistance	10 to 300 Hz, 43 m/s <sup>2</sup> [Approx. 4.4 G] min. (misoperating)		
Ambient Temperature	-40 °C to +125 °C (-40 °F to +257 °F)		
Coil Temperature Rise	50 °C / W (without contact carrying current)		
Life Expectancy	Mechanical	1 × 10 <sup>6</sup> operations	
	Electrical	Contact G	1 × 10 <sup>5</sup> operations (at 14 Vdc, Motor Load 25 A / 7 A) at 25 °C 1 × 10 <sup>5</sup> operations (at 14 Vdc, Motor Load 18 A / 5 A) at 125 °C
		Contact L or N	1 × 10 <sup>5</sup> operations (at 14 Vdc, Motor Load 20 A / 3 A) at 25 °C 1 × 10 <sup>5</sup> operations (at 14 Vdc, Motor Load 12 A / 2 A) at 125 °C
Weight	Approx. 15 gr	Approx. 8 gr	

## COIL RATING

## EP2F SERIES

at 25 °C (77 °F)

	Part Number		Nominal Voltage (Vdc)	Coil Resistance (Ω ± 10%)	Must Operate Voltage (Vdc max.)	Must Release Voltage (Vdc min.)	Nominal Operate Power (W)
	H Bridge Type	Separate Type					
Contact G	EP2F-B3G1	EP2F-B3G1T	12	225	6.5	0.9	0.64
	EP2F-B3G2	EP2F-B3G2T	12	225	7.0	0.9	0.64
	EP2F-B3G3	EP2F-B3G3T	12	225	7.5	0.9	0.64
Contact L or N	EP2F-B3L1	EP2F-B3L1T	12	225	6.5	0.9	0.64
	EP2F-B3L2	EP2F-B3L2T	12	225	7.0	0.9	0.64
	EP2F-B3L3	EP2F-B3L3T	12	225	7.5	0.9	0.64

## EP1F SERIES

	Part Number	Nominal Voltage (Vdc)	Coil Resistance (Ω ± 10%)	Must Operate Voltage (Vdc max.)	Must Release Voltage (Vdc min.)	Nominal Operate Power (W)
Contact G	EP1F-B3G1	12	225	6.5	0.9	0.64
	EP1F-B3G2	12	225	7.0	0.9	0.64
	EP1F-B3G3	12	225	7.5	0.9	0.64
Contact L or N	EP1F-B3L1	12	225	6.5	0.9	0.64
	EP1F-B3L2	12	225	7.0	0.9	0.64
	EP1F-B3L3	12	225	7.5	0.9	0.64



- All specifications in this catalog and production status of products are subject to change without notice. Prior to the purchase, please contact NEC Tokin for updated product data.
- Please request for a specification sheet for detailed product data prior to the purchase.
- Before using the product in this catalog, please read "Precautions" and other safety precautions listed in the printed version catalog.

NUMBERING SYSTEM

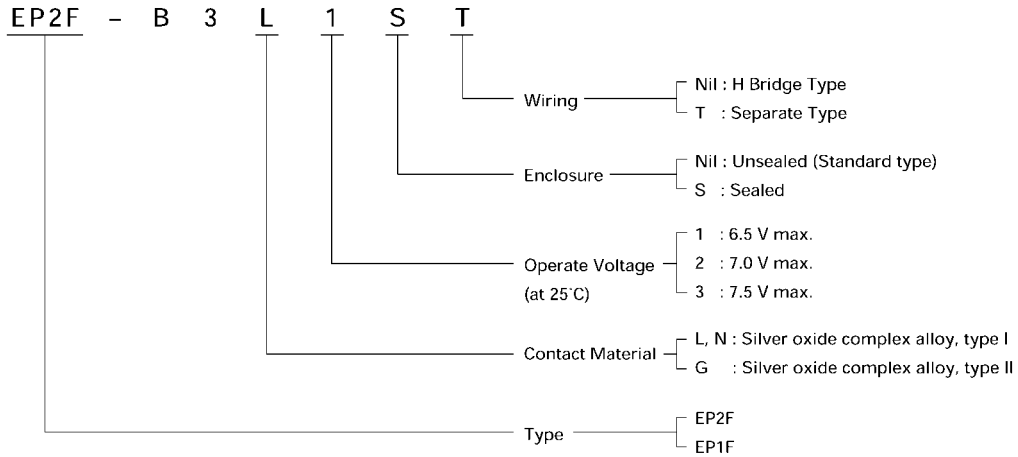

TYPICAL APPLICATION (H Bridge Type)

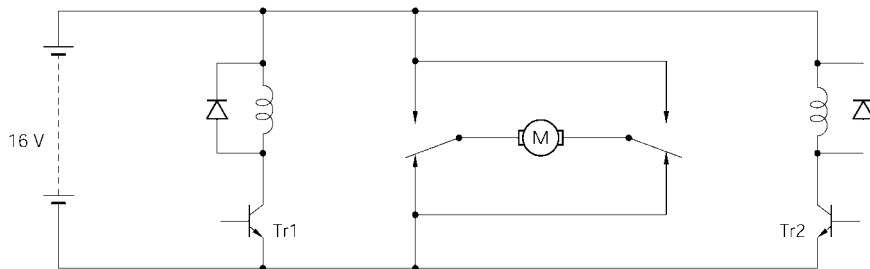

MOTOR	Tr1	Tr2
STOP	off	off
FORWARD	on	off
REVERSE	off	on

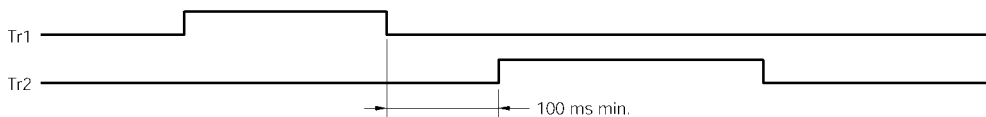

It is necessary to take more than 100 msec intervals for on / off timing between driving Tr1 and Tr2. If the interval is less than 100 msec, an excessive current happens to flow to the relay contacts.



- All specifications in this catalog and production status of products are subject to change without notice. Prior to the purchase, please contact NEC Tokin for updated product data.
- Please request for a specification sheet for detailed product data prior to the purchase.
- Before using the product in this catalog, please read "Precautions" and other safety precautions listed in the printed version catalog.

TECHNICAL DATA

Coil Temperature (EP2F-B3L1)

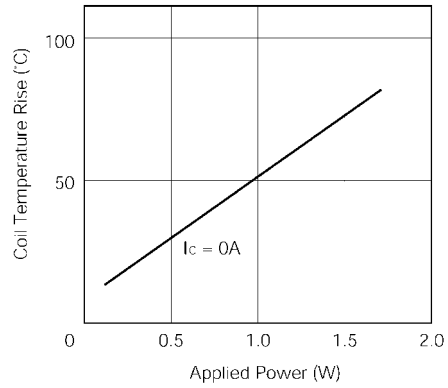
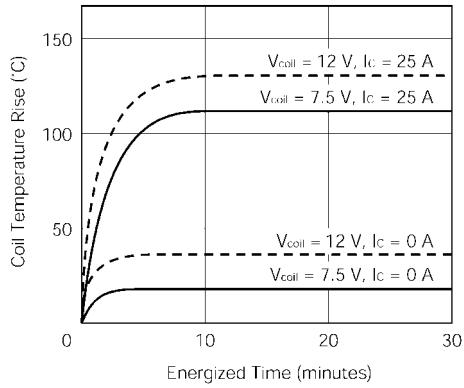

Operate Time (EP2F-B3L1)

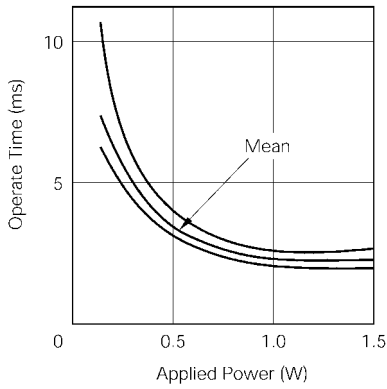

Release time (EP2F-B3L1)

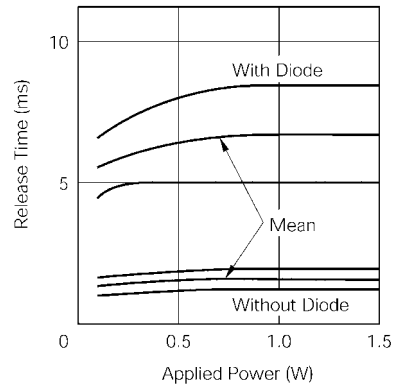

- All specifications in this catalog and production status of products are subject to change without notice. Prior to the purchase, please contact NEC Tokin for updated product data.
- Please request for a specification sheet for detailed product data prior to the purchase.
- Before using the product in this catalog, please read "Precautions" and other safety precautions listed in the printed version catalog.



- All specifications in this catalog and production status of products are subject to change without notice. Prior to the purchase, please contact NEC Tokin for updated product data.
- Please request for a specification sheet for detailed product data prior to the purchase.
- Before using the product in this catalog, please read "Precautions" and other safety precautions listed in the printed version catalog.

No part of this document may be copied or reproduced in any form or by any means without the prior written consent of NEC/TOKIN Corporation. NEC/TOKIN Corporation assumes no responsibility for any errors which may appear in this document.

NEC/TOKIN Corporation does not assume any liability for infringement of patents, copyrights or other intellectual property rights of third parties by or arising from use of a device described herein or any other liability arising from use of such device. No license, either express, implied or otherwise, is granted under any patents, copyrights or other intellectual property rights of NEC/TOKIN Corporation or others. While NEC/TOKIN Corporation has been making continuous effort to enhance the reliability of its electronic components, the possibility of defects cannot be eliminated entirely. To minimize risks of damage or injury to persons or property arising from a defect in an NEC/TOKIN electronic component, customers must incorporate sufficient safety measures in its design, such as redundancy, fire-containment, and anti-failure features. NEC/TOKIN devices are classified into the following three quality grades:

"Standard", "Special", and "Specific". The Specific quality grade applies only to devices developed based on a customer designated "quality assurance program" for a specific application. The recommended applications of a device depend on its quality grade, as indicated below. Customers must check the quality grade of each device before using it in a particular application.

**Standard:** Computers, office equipment, communications equipment, test and measurement equipment, audio and visual equipment, home electronic appliances, machine tools, personal electronic equipment and industrial robots

**Special:** Transportation equipment (automobiles, trains, ships, etc.), traffic control systems, anti-disaster systems, anti-crime systems, safety equipment and medical equipment (not specifically designed for life support)

**Specific:** Aircrafts, aerospace equipment, submersible repeaters, nuclear reactor control systems, life support systems or medical equipment for life support, etc.

The quality grade of NEC/TOKIN devices is "Standard" unless otherwise specified in NEC/TOKIN's Data Sheets or Data Books. If customers intend to use NEC/TOKIN devices for applications other than those specified for Standard quality grade, they should contact an NEC/TOKIN sales representative in advance.

(Note)

- (1) "NEC/TOKIN" as used in this statement means NEC/TOKIN Corporation and also includes its majorityowned subsidiaries.
- (2) "NEC/TOKIN electronic component products" means any electronic component product developed or manufactured by or for NEC/TOKIN (as defined above).

DE0202

Printed on recycled paper



- All specifications in this catalog and production status of products are subject to change without notice. Prior to the purchase, please contact NEC Tokin for updated product data.
- Please request for a specification sheet for detailed product data prior to the purchase.
- Before using the product in this catalog, please read "Precautions" and other safety precautions listed in the printed version catalog.