

Features

- **Global certificates**
- Universal AC input / Full range
- 3 pole AC inlet IEC320-C14, Class I power unit
- Built-in active PFC function
- No load power consumption < 0.15W
- **Energy efficiency Level VI**
- Comply with EISA 2007/DoE, NRCAN, AU/NZ MEPS, EU ErP and CoC Version 5
- Protections: Short circuit / Overload / Over voltage / Over temperature
- -30~+70°C wide range working temperature
- Fully enclosed plastic case
- LED indicator for power on
- Various DC plug quick adapter accessory available
(Plug kit sold separately, please refer to : http://www.meanwell.com/upload/pdf/DC_plug.pdf)
- 3 years warranty

Applications

- Consumer electronic devices
- Telecommunication devices
- Office facilities
- Industrial equipments

Description

GST160A is a highly reliable, 160W desktop style single-output green adaptor series. This product is a class I power unit (with FG), equipped with a standard IEC320-C14 AC inlet and adopting the input range from 85VAC to 264VAC. The entire series supplies different models with output voltages ranging between 12VDC and 48VDC that can satisfy the demands for various types of consumer electronic devices. With the efficiency up to 94% and the extremely low no-load power consumption below 0.15W, GST160A is compliant with USA EISA 2007/DoE, Canada NRCAN, Australia and New Zealand MEPS, Korea K-MEPS, EU ErP and Code of Conduct (CoC) Version 5. The supreme feature allows the adaptor to save the energy when it is either under the operating mode or the standby mode. The entire series utilizes the 94V-0 flame retardant plastic case. GST160A is certified for the international safety regulations.

Model Encoding

GST 160A 12 -R7B

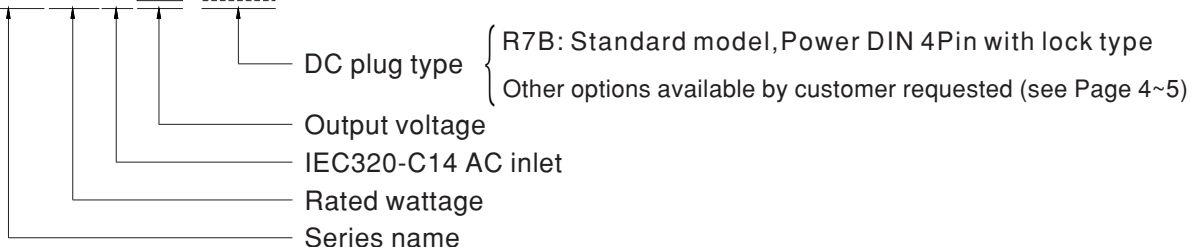

SPECIFICATION

ORDER NO.	GST160A12-R7B	GST160A15-R7B	GST160A20-R7B	GST160A24-R7B	GST160A36-R7B	GST160A48-R7B		
OUTPUT	SAFETY MODEL NO.	GST160A12	GST160A15	GST160A20	GST160A24	GST160A36	GST160A48	
	DC VOLTAGE Note.2	12V	15V	20V	24V	36V	48V	
	RATED CURRENT	11.5A	9.6A	8A	6.67A	4.44A	3.34A	
	CURRENT RANGE	0 ~ 11.5A	0 ~ 9.6A	0 ~ 8A	0 ~ 6.67A	0 ~ 4.44A	0 ~ 3.34A	
	RATED POWER (max.)	138W	144W	160W	160W	160W	160W	
	RIPPLE & NOISE (max.) Note.3	80mVp-p	100mVp-p	120mVp-p	150mVp-p	150mVp-p	200mVp-p	
	VOLTAGE TOLERANCE Note.4	±5.0%	±5.0%	±4.0%	±3.0%	±3.0%	±3.0%	
	LINE REGULATION Note.5	±1.0%	±1.0%	±1.0%	±1.0%	±1.0%	±1.0%	
	LOAD REGULATION	±5.0%	±5.0%	±4.0%	±3.0%	±3.0%	±3.0%	
	SETUP, RISE TIME Note.6	2000ms, 50ms / 230VAC 2500ms, 50ms / 115VAC at full load						
HOLD UP TIME (Typ.)	20ms / 230VAC 20ms / 115VAC at full load							
INPUT	VOLTAGE RANGE Note.7	85 ~ 264VAC 120 ~ 370VDC						
	FREQUENCY RANGE	47 ~ 63Hz						
	POWER FACTOR (Typ.)	12V/15V:PF>0.93 / 230VAC		20V,24V,48V:PF>0.94 / 230VAC		PF>0.98 / 115VAC at full load		
	EFFICIENCY (Typ.)	90%	91%	93%	93%	92%	94%	
	AC CURRENT	1.85A / 115VAC		1A / 230VAC				
	INRUSH CURRENT (max.)	Cold start 95A / 115VAC		120A / 230VAC				
LEAKAGE CURRENT(max.)	0.75mA / 240VAC							
PROTECTION	OVERLOAD	105 ~ 150% rated output power Protection type : Hiccup mode, recovers automatically after fault condition is removed						
	OVER VOLTAGE	105 ~ 135% rated output voltage Protection type : Hiccup mode @ 10%load						
	OVER TEMPERATURE	Protection type : Shut down o/p voltage, re-power on to recover						
ENVIRONMENT	WORKING TEMP.	-30 ~ +70°C (Refer to "Derating Curve")						
	WORKING HUMIDITY	20% ~ 90% RH non-condensing						
	STORAGE TEMP., HUMIDITY	-40 ~ +85°C , 10 ~ 95% RH non-condensing						
	TEMP. COEFFICIENT	±0.03% / °C (0~50°C)						
	VIBRATION	10 ~ 500Hz, 2G 10min./1cycle, period for 60min. each along X, Y, Z axes						
SAFETY & EMC (Note. 9)	SAFETY STANDARDS Note. 8	UL62368-1, CSA C22.2 No.62368-1, TUV EN62368-1, BSMI CNS14336, CCC GB4943.1, PSE J62368-1, AS/NZS 60950.1, BIS IS13252, KC K60950-1, EAC TP TC 004 approved; SIRIM MS IEC60950-1 (optional) approved						
	WITHSTAND VOLTAGE	I/P-O/P: 3KVAC I/P-FG: 2KVAC O/P-FG: SHORT						
	ISOLATION RESISTANCE	I/P-O/P: 100M Ohms / 500VDC / 25°C / 70% RH						
	EMC EMISSION	Parameter	Standard				Test Level / Note	
		Conducted emission	EN55032(CISPR32), FCC PART 15 / CISPR22 CAN ICES-3(B)/NMB-3(B), CNS13438, GB17625.1 EAC TP TC 020, MSIP KN32				Class B	
		Radiated emission	EN55032(CISPR32), FCC PART 15 / CISPR22 CAN ICES-3(B)/NMB-3(B), CNS13438, GB17625.1 EAC TP TC 020, MSIP KN32				Class B	
		Harmonic current	EN61000-3-2, GB9254				Class A	
	Voltage flicker	EN61000-3-3				-----		
	EMC IMMUNITY	Parameter	Standard				Test Level / Note	
		ESD	EN61000-4-2				Level 4, 15KV air; Level 4, 8KV contact	
RF field susceptibility		EN61000-4-3				Level 2, 3V/m		
EFT bursts		EN61000-4-4				Level 2, 1KV		
Surge susceptibility		EN61000-4-5				Level 3, 1KV/Line-Line , 2KV/Line-FG		
Conducted susceptibility		EN61000-4-6				Level 2, 3V		
Magnetic field immunity		EN61000-4-8				Level 2, 3A/m		
Voltage dips , interruption	EN61000-4-11				>95% dip 0. 5 periods, 30% dip 25 periods, >95% interruptions 250 periods			
OTHERS	MTBF	236.4K hrs min. MIL-HDBK-217F(25°C)						
	DIMENSION	175*72*35mm (L*W*H)						
	PACKING	0.66Kg; 20pcs/ 14.2Kg/ 1.06CUFT						
CONNECTOR	PLUG	See page 4~5 ; Other type available by customer requested						
	CABLE	See page 4~5 ; Other type available by customer requested						
NOTE	1. All parameters are specified at 230VAC input, rated load, 25°C 70% RH ambient. 2. DC voltage: The output voltage set at point measure by plug terminal & 50% load. 3. Ripple & noise are measured at 20MHz by using a 12" twisted pair terminated with a 0.1µf & 47µf capacitor. 4. Tolerance: includes set up tolerance, line regulation, load regulation. 5. Line regulation is measured from low line to high line at rated load. 6. Length of set up time is measured at first cold start. Turning ON/OFF the power supply may lead to increase of the set up time. 7. Derating may be needed under low input voltage. Please check the derating curve for more details. 8. The demand for Malaysia safety is processed with the order no. GST160A □ -SIRIM by request. Please contact MEAN WELL for details. 9. The power supply is considered as an independent unit, but the final equipment still need to re-confirm that the whole system complies with the EMC directives. For guidance on how to perform these EMC tests, please refer to "EMI testing of component power supplies." (as available on http://www.meanwell.com)							

Derating Curve

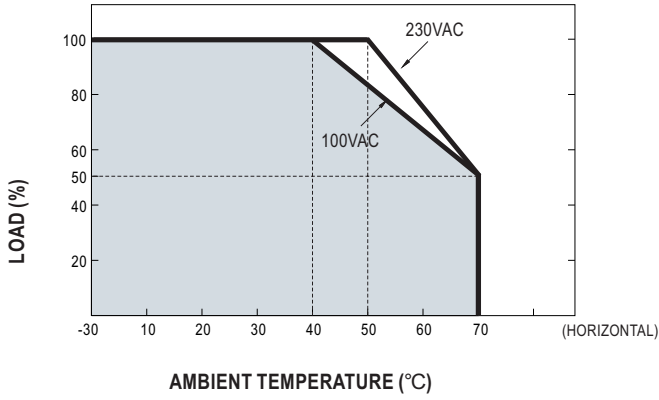

Static Characteristics

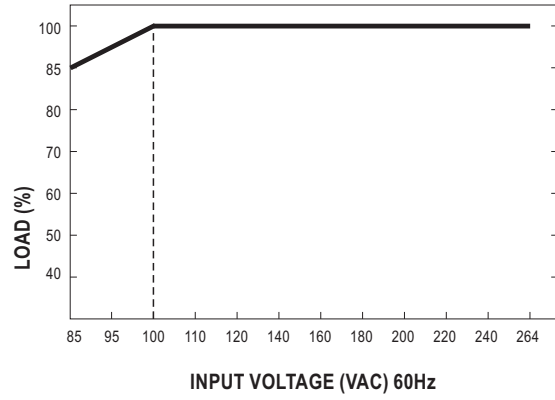

Mechanical Specification

Case No. GS160A
Unit:mm

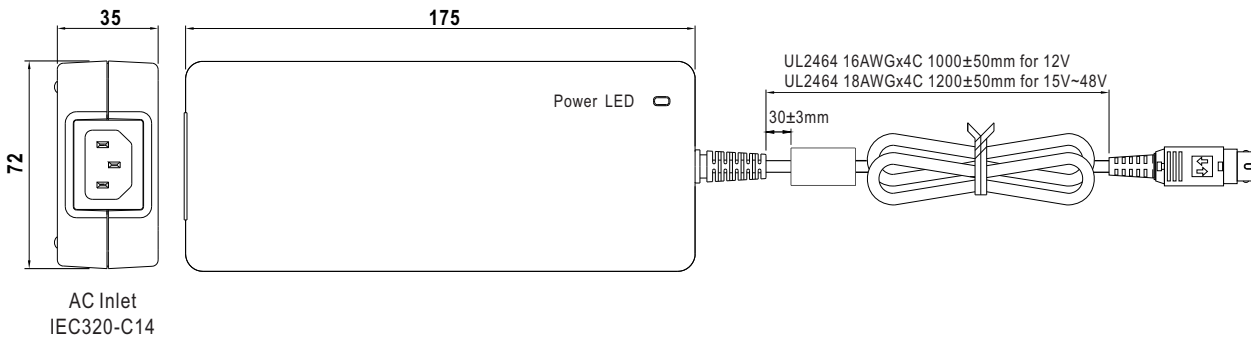

DC output plug

Standard plug: R7B

R7B		Pin Assignment											
	KYCON KPPX-4P equivalent	AC FG											
		-V connected to AC FG											
			<table border="1"> <thead> <tr> <th>PIN NO.</th> <th>OUTPUT</th> </tr> </thead> <tbody> <tr> <td>1</td> <td>+Vo</td> </tr> <tr> <td>2</td> <td>-Vo</td> </tr> <tr> <td>3</td> <td>-Vo</td> </tr> <tr> <td>4</td> <td>+Vo</td> </tr> </tbody> </table>	PIN NO.	OUTPUT	1	+Vo	2	-Vo	3	-Vo	4	+Vo
PIN NO.	OUTPUT												
1	+Vo												
2	-Vo												
3	-Vo												
4	+Vo												

- ⦿ Plug changeable with quick adapter (sold seperately)
(Changeable DC plug selection guide : http://www.meanwell.com/upload/pdf/DC_plug.pdf)

For example :

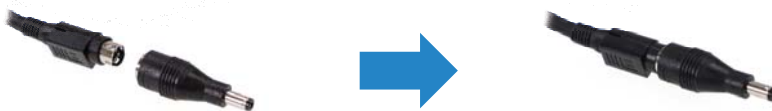

- ⦿ Optional DC plug:

Tuning Fork Style	Type No.	A OD	B ID	C L	Quick Adapter Accessory
<p>Current rating: 7.5A max.</p> <p>(Straight)</p>	P1J	5.5	2.1	11.0	Available (for 24 ~ 48V)
	P1M	5.5	2.5	11.0	
Min. DIN 4 Pin with Lock (female)	Type No.	Pin Assignment			
<p>Current rating: 7.5A max.</p> <p>KYCON KPJX-CM-4S equivalent</p>	R7BF	PIN No.	Output		None
		1	+Vo		
		2	-Vo		
		3	-Vo		
DIN 5 Pin (male)	Type No.	Pin Assignment			
<p>Current rating: 7.5A max.</p>	R1B	PIN No.	Output		None
		1	-Vo		
		2	-Vo		
		3	+Vo		
		4	-Vo		
NEUTRIK XLR NC4FX equivalent	Type No.	Pin Assignment			
	MIC4	PIN No.	Output		None
		1	+Vo		
		2	+Vo		
		3	-Vo		
MOLEX 39-01-2060 (4.2mm) equivalent	Type No.	Pin Assignment			
<p>FG not connected to output connector</p>	C6P	PIN No.	Output		None
		1	+Vo		
		2	+Vo		
		3	+Vo		
		4	-Vo		
		5	-Vo		
6	-Vo				

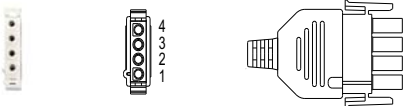
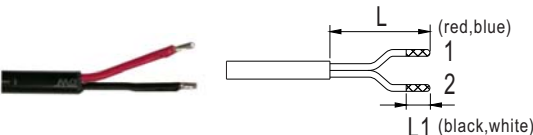
AMP 1-480702-0 (6.35mm) equivalent	Type No.	Pin Assignment		Quick Adapter Accessory
		PIN No.	Output	
 <p>FG not connected to output connector</p>	C4P	1	+Vo	None
		2	+Vo	
		3	-Vo	
		4	-Vo	
Stripped and tinned leads	Type No.	Pin Assignment		None
 <p>Length of Land L1 by request (MW's standard length, L: <u>25</u> mm, L1: <u>5</u> mm)</p>	by customer	1	+Vo	
		2	-Vo	

■ Installation Manual

Please refer to : <http://www.meanwell.com/manual.html>