



IS 13252(Part 1)
IEC 60950-1
R-41070483



■ Features

- AC input 180~264VAC
- Withstand 300VAC surge input for 5 seconds
- Design against rain splash
- Protections: Short circuit / Overload / Over voltage/ Over temperature
- Cooling by free air convection
- LED indicator for power on
- Low cost,high reliability
- 100% full load burn-in test
- 3 years warranty

■ Applications

- LED strip lighting
- LED channel letters
- LED display

■ Description

ERP-200 series is a 200W single output enclosed type AC/DC power supply . It adopts an aluminum case and the interior is semi-potted, protecting the internal electronic components from rain splash and dust. With the complete protection functions, ERP-200 is suitable for the applications such as outdoor LED channel letters, billboard, commercial display, etc.

■ Model Encoding

ERP - 200 - 12

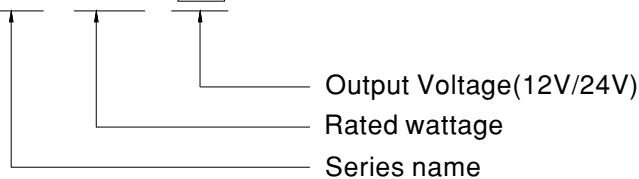



SPECIFICATION

MODEL		ERP-200-12	ERP-200-24
OUTPUT	DC VOLTAGE	12V	24V
	RATED CURRENT	16.8A	8.33A
	CURRENT RANGE	0~16.8A	0~8.33A
	RATED POWER	200.4W	199.92W
	RIPPLE & NOISE (max.) Note.2	150mVp-p	150mVp-p
	VOLTAGE ADJ. RANGE	10.8 ~ 13.2V	21.6 ~ 26.4V
	VOLTAGE TOLERANCE Note.3	±1.0%	±1.0%
	LINE REGULATION	±0.5%	±0.5%
	LOAD REGULATION	±0.5%	±0.5%
	SETUP, RISE TIME	1500ms, 200ms/230VAC	
HOLD UP TIME (Typ.)	20ms/230VAC		
INPUT	VOLTAGE RANGE	180 ~ 264VAC 254 ~ 370VDC	
	FREQUENCY RANGE	47 ~ 63Hz	
	EFFICIENCY (Typ.)	87%	89%
	AC CURRENT (Typ.)	4A/230VAC	
	INRUSH CURRENT (Typ.)	90A/230VAC	
	LEAKAGE CURRENT	<1mA / 240VAC	
PROTECTION	SHORT CIRCUIT	Hiccup mode, recovers automatically after fault condition is removed	
	OVER LOAD	110 ~ 140% rated output power	
		Protection type : Constant current limiting, recovers automatically after fault condition is removed	
	OVER VOLTAGE	13.8 ~ 16.2V	27.6 ~ 32.4V
		Protection type : Hiccup mode, recovers automatically after fault condition is removed	
OVER TEMPERATURE	Shut down O/P voltage, recovers automatically after temperature goes down		
ENVIRONMENT	WORKING TEMP.	-30 ~ +60°C (Refer to output load derating curve)	
	WORKING HUMIDITY	20 ~ 90% RH non-condensing	
	STORAGE TEMP., HUMIDITY	-30 ~ +85°C, 10 ~ 95% RH	
	TEMP. COEFFICIENT	±0.05%/°C (0 ~ 50°C)	
	VIBRATION	10 ~ 500Hz, 3G 10min./1cycle, 60min. each along X, Y, Z axes	
SAFETY & EMC	SAFETY STANDARDS	IEC/EN 62368-1, GB4943.1-2011(except for ERP-200-12), EAC TP TC 004, IS13252(Part1) approved	
	WITHSTAND VOLTAGE	I/P-O/P:3KVAC I/P-FG:2KVAC O/P-FG:0.5KVAC	
	ISOLATION RESISTANCE	I/P-O/P, I/P-FG, O/P-FG:100M Ohms/500VDC / 25°C / 70% RH	
	EMC EMISSION	Refer to EN55022 (CISPR22) class A, EAC TP TC 020	
	EMC IMMUNITY	Refer to EN61000-4-5; light industry level, criteria A, EAC TP TC 020	
OTHERS	MTBF	321.040Khrs min. MIL-HDBK-217F (25°C)	
	DIMENSION	200*120*40mm (L*W*H)	
	PACKING	0.86Kg; 12 pcs/10.89Kg/0.58CUFT	
NOTE	<p>1. All parameters NOT specially mentioned are measured at 230VAC input, rated load and 25°C of ambient temperature.</p> <p>2. Ripple & noise are measured at 20MHz of bandwidth by using a 12" twisted pair-wire terminated with a 0.1uf & 47uf parallel capacitor.</p> <p>3. Tolerance : includes set up tolerance, line regulation and load regulation.</p> <p>※ Product Liability Disclaimer : For detailed information, please refer to https://www.meanwell.com/serviceDisclaimer.aspx</p>		

■ Block Diagram

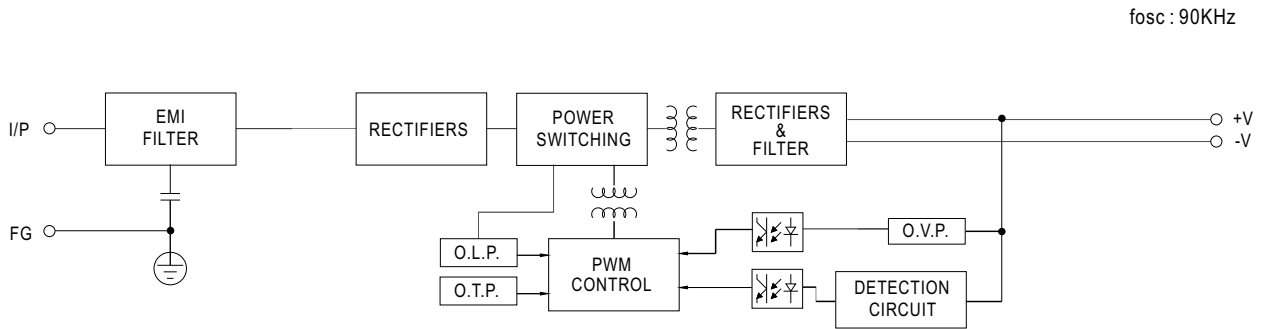

■ Derating Curve

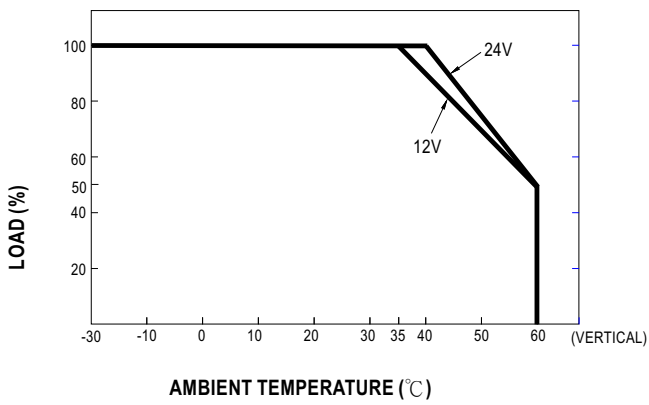

■ Static Characteristics

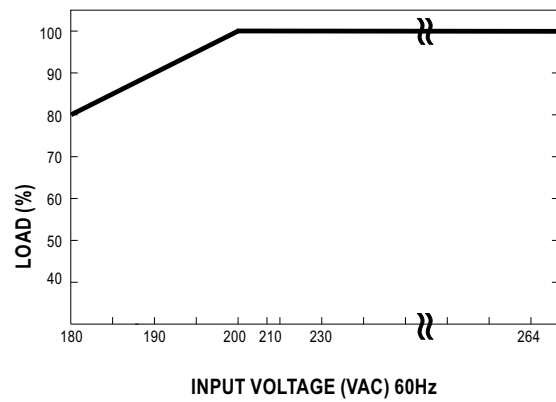

■ Mechanical Specification

Case No.273 Unit:mm

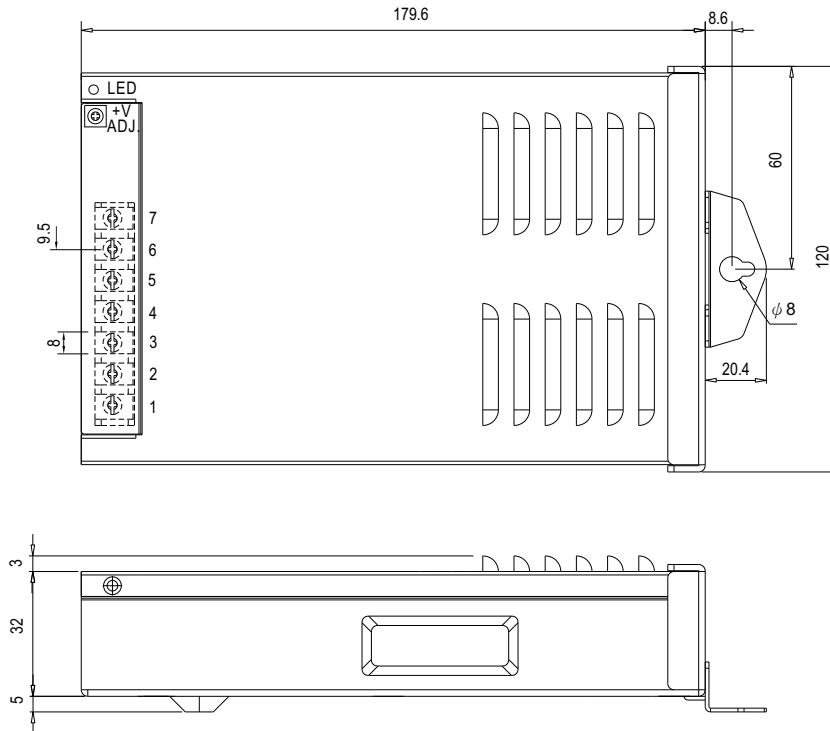

Terminal Pin No. assignment :

Pin No.	Assignment	Pin No.	Assignment
1	AC/L	4-5	DC OUTPUT -V
2	AC/N	6-7	DC OUTPUT +V
3	FG \perp		

■ Installation

1. ERP-200 is designed for outdoor application and should be installed in the place with shelter.
2. ERP-200 should be installed in an upright position, leaning forward, backward or lay flat are not allowed

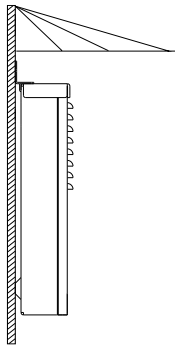

Correct installation method

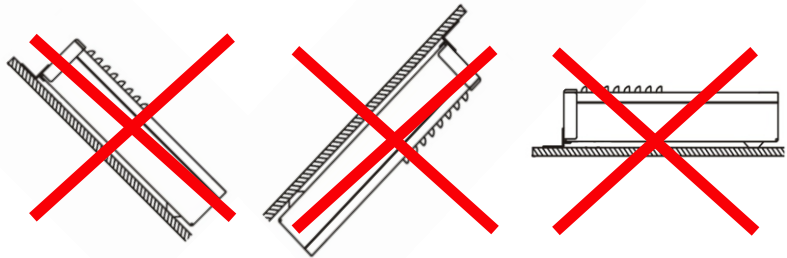

Faulty installation methods

3. For heat dissipation, at least 10cm installation distance around the PSU should be kept, shown as below:

