

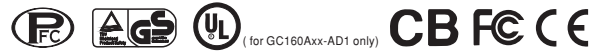

■ Features :

- Charger for lead-acid batteries (flooded,Gel and AGM) and Li-ion batteries (lithium iron and lithium manganese) (Note.1)
- 2 stage charging characteristic
- Universal AC input / Full range
- Built-in active PFC function, PF>0.94
- No load power consumption<1W
- 3 pole AC inlet IEC320-C14
- Class I power (with earth pin)
- Protections: Short circuit / Overload / Over voltage / Over temperature
- Cooling by free air convection
- Fully enclosed plastic case
- 2 color LED indicator for charging status
- Approvals: TUV / UL / CB / FCC / CE
- 2 years warranty



ORDER NO.	OUTPUT CONNECTOR	SAFETY
GC160Axx-R7B (standard model)	4pin power din	TUV / CB / FCC / CE
GC160Axx-AD1 (optional model)	Anderson connector	UL / TUV / CB / FCC / CE
GC160Axx-□ xx=12,24,48 ; □=R7B,AD1		

SPECIFICATION

ORDER NO.	GC160A12-□	GC160A24-□	GC160A48-□	
OUTPUT	SAFETY MODEL NO.	GC160A12	GC160A24	GC160A48
	DC VOLTAGE (Typ.)	13.6V	27.2V	54.4V
	RECOMMENDED BATTERY CAPACITY <small>Note.3</small>	60 ~160Ah	30 ~ 90Ah	15 ~ 45Ah
	CONTINUOUS OUTPUT CURRENT (Typ.)	10A	5.89A	2.95A
	RATED POWER	136W	160.2W	160.5W
LED INDICATOR		Charging(CC) : RED Floating charging(CV) : GREEN		
INPUT	VOLTAGE RANGE <small>Note.4</small>	85 ~ 264VAC 120 ~ 370VDC		
	FREQUENCY RANGE	47 ~ 63Hz		
	POWER FACTOR (Typ.)	PF>0.94 / 230VAC PF>0.98 / 115VAC at full load		
	EFFICIENCY (Typ.)	89%	92.5%	94%
	AC CURRENT	1.85A / 115VAC 1A / 230VAC		
	INRUSH CURRENT (max.)	120A / 230VAC		
LEAKAGE CURRENT(max.)	0.75mA / 240VAC			
PROTECTION	OVERLOAD <small>Note.5</small>	90 ~ 110% rated output power Protection type : Constant current limiting recovers automatically after fault condition is removed		
	SHORT CIRCUIT	Protection type : Hiccup mode, recovers automatically after fault condition is removed		
	OVER VOLTAGE	105 ~ 135% rated output voltage Protection type : Shut down o/p voltage, re-power on to recover		
	OVER TEMPERATURE	90°C ±10°C (RTH2) detect on inside ambient temperature Protection type : Shut down o/p voltage, re-power on to recover		
ENVIRONMENT	WORKING TEMP.	-30 ~ +70°C (Refer to "Derating Curve")		
	WORKING HUMIDITY	20% ~ 90% RH non-condensing		
	STORAGE TEMP., HUMIDITY	-40 ~ +85°C, 10 ~ 95% RH		
	TEMP. COEFFICIENT	±0.03% / °C (0~50°C)		
	VIBRATION	10 ~ 500Hz, 2G 10min./1cycle, period for 60min. each along X, Y, Z axes		
SAFETY & EMC (Note. 6)	SAFETY STANDARDS	UL1012 (for GC160Axx-AD1 only), TUV EN60950-1 approved		
	WITHSTAND VOLTAGE	I/P-O/P: 3KVAC		
	ISOLATION RESISTANCE	I/P-O/P:100M Ohms / 500VDC / 25°C / 70% RH		
	EMC EMISSION	Compliance to EN55032 class B, FCC PART 15 class B / CISPR32 class B, EN61000-3-2,3		
OTHERS	EMC IMMUNITY	Compliance to EN61000-4-2,3,4,5,6,8,11, light industry level, criteria A		
	MTBF	274.1Khrs min. MIL-HDBK-217F(25°C)		
	DIMENSION	175*72*35mm (L*W*H)		
CONNECTOR	PACKING	0.7Kg; 20pcs/15Kg/0.85CUFT(GC160Axx-R7B) 0.77Kg; 20pcs/16.4Kg/1.15CUFT(GC160Axx-AD1)		
	PLUG	See page 2 ; Other type available by customer requested		
	CABLE	See page 2 ; Other type available by customer requested		

NOTE

1. Modification for charger specification may be required for different battery specification. Please contact battery vendor and MEAN WELL for details.
2. All parameters NOT specially mentioned are measured at 230VAC input, rated load and 25°C of ambient temperature.
3. This is MeanWell's suggested range, please consult your battery manufacturer for their suggestions about maximum charging current limitation.
4. Derating may be needed under low input voltage. Please check the derating curve for more details.
5. Constant current operation region is within 50~100% rated output voltage.
6. The power supply is considered a component which will be installed into a final equipment. The final equipment must be re-confirmed that it still meets EMC directives.

■ Mechanical Specification

Case No.997A Unit:mm

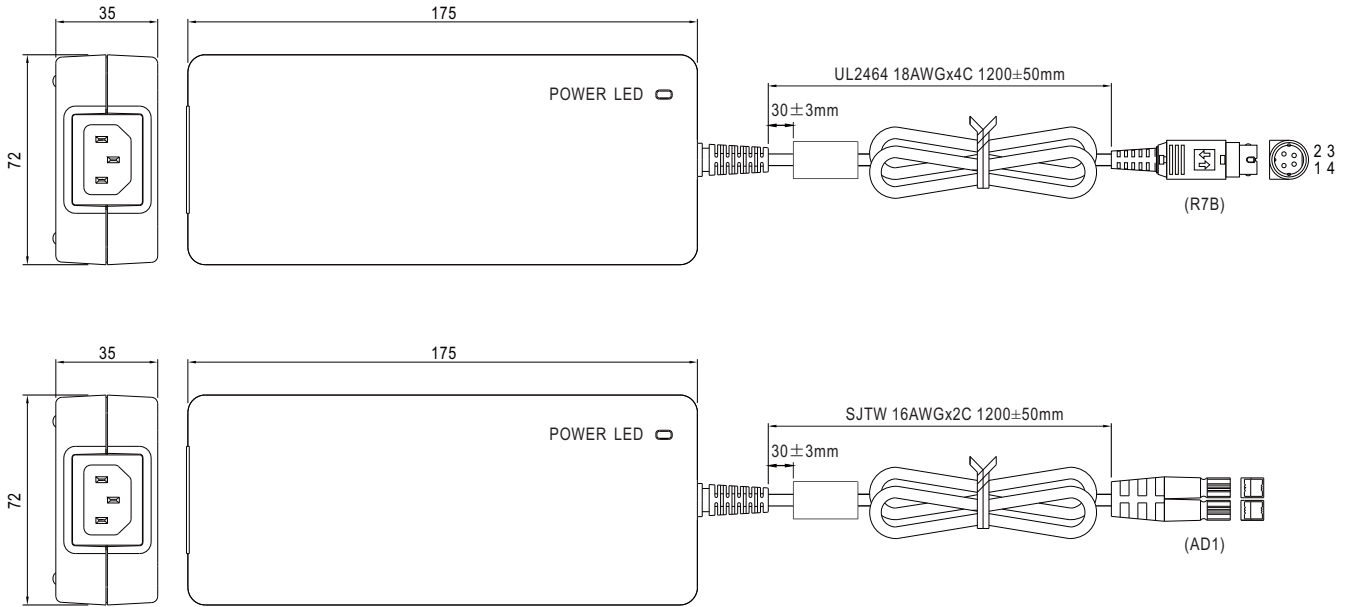

■ Plug Assignment

DC output connector (standard)

R7B (KYCON KPP-4S or equivalent)	
PIN NO.	OUTPUT
1,4	+V
2,3	-V

AC FG

-V connected to AC FG

DC output connector (optional)

AD1	
[housing: Anderson 1327FP(red), 1327G6FP(black) contacts: Anderson 261G2 (45A) or equivalent]	
Red(+V)	Black(-V)

■ Charging Curve

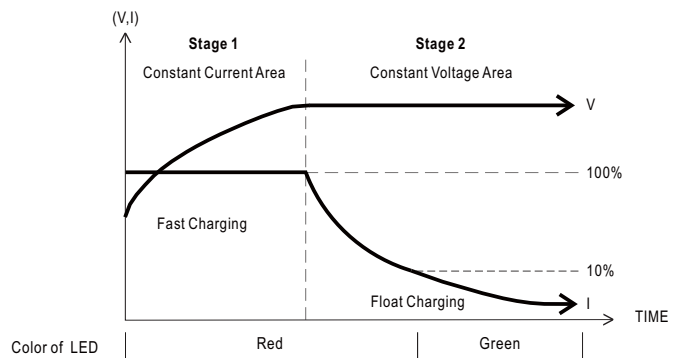

Model	Suggested Battery capacity
GC160A12	60-160Ah
GC160A24	30-90Ah
GC160A48	15-45Ah

Suitable for lead-acid batteries (flooded, Gel and AGM) and Li-ion batteries (lithium iron and lithium manganese)

■ Derating Curve

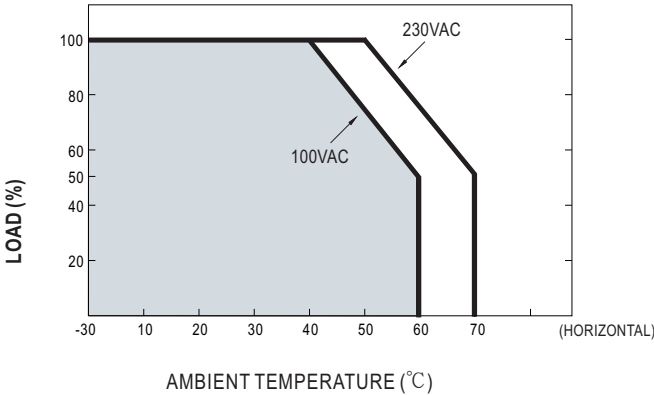

■ Static Characteristics

