



Dimension		
L	W	H
295	127	41 (1U) mm
11.6	5	1.61(1U) inch



Features

- Universal AC input / Full range
- Built-in active PFC function
- High efficiency up to 89%
- Forced air cooling by built-in DC fan
- Output voltage programmable
- Built-in OR-ing diode, support hot swap (hot plug)
- Active current sharing up to 3000W for one 19" rack shelf
- Optiona I²C interface
- Protections: Short circuit / Overload / Over voltage / Over temperature
- Optional conformal coating
- 5 years warranty

Certificates

- Safety: UL/EN/IEC 60950-1
- EMC: EN 55022 / 55024

Applications

- Industrial automation
- Distributed power architecture system
- Wireless/telecommunication solution
- Redundant power system
- Electric vehicle charger system
- Constant current source system

Description

RCP-1000 is a 1KW single output rack mountable front end AC/DC power supply This series operates for 90~264VAC input voltage and offers the models with the DC output mostly demanded from the industry. Each model is cooled by the built-in DC fan with fan speed control, working for the temperature up to 60°C. RCP-1000 provides vast design flexibility by equipping various built-in functions such as the output programming, active current sharing (up to 8000W via three 19" rack shelves, RCP-1U), remote control, auxiliary power, alarm signal, etc.

Model Encoding / Order Information

RCP - 1000 - 24 □

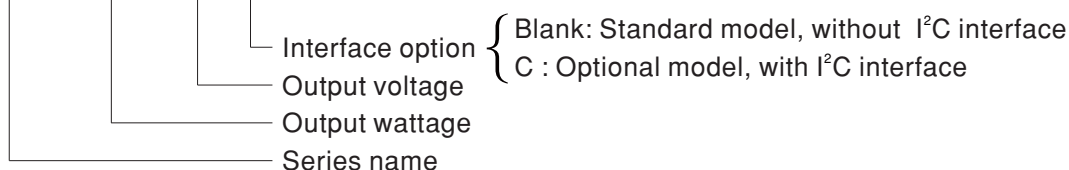

※ Note: 19" rack shelf, RCP-1U, available. Details available on <http://www.meanwell.com/>

SPECIFICATION

MODEL		RCP-1000-12	RCP-1000-24	RCP-1000-48	
OUTPUT	DC VOLTAGE	12V	24V	48V	
	RATED CURRENT	60A	40A	21A	
	CURRENT RANGE	0 ~ 60A	0 ~ 40A	0 ~ 21A	
	RATED POWER	720W	960W	1008W	
	RIPPLE & NOISE (max.) Note.2	150mVp-p	200mVp-p	300mVp-p	
	VOLTAGE ADJ. RANGE(SVR)	11.6 ~ 12.4V	23.2 ~ 24.8V	46.3 ~ 49.7V	
	VOLTAGE TOLERANCE Note.3	±1.0%	±1.0%	±1.0%	
	LINE REGULATION	±0.5%	±0.5%	±0.5%	
	LOAD REGULATION	±0.5%	±0.5%	±0.5%	
	SETUP, RISE TIME	1000ms, 60ms/230VAC at full load			
HOLD UP TIME (Typ.)	16ms/230VAC at full load				
INPUT	VOLTAGE RANGE Note.4	90 ~ 264VAC 127 ~ 370VDC			
	FREQUENCY RANGE	47 ~ 63Hz			
	EFFICIENCY (Typ.)	81%	87%	89%	
	AC CURRENT (Typ.)	8.5A/115VAC 4.5A/230VAC	10.5A/115VAC 5.5A/230VAC	11A/115VAC 5.5A/230VAC	
	INRUSH CURRENT (Typ.)	COLD START 50A			
	LEAKAGE CURRENT	<1.1mA / 230VAC			
PROTECTION	OVERLOAD	105 ~ 125% rated output power Protection type : Constant current limiting, recovers automatically after fault condition is removed			
	OVER VOLTAGE	13.2 ~ 16.2V	26.4 ~ 32.4V	52.8 ~ 64.8V	
		Protection type : Shut down o/p voltage, re-power on to recover			
OVER TEMPERATURE	Shut down o/p voltage, recovers automatically after temperature goes down				
FUNCTION	AUXILIARY POWER	5V @ 0.3A			
	REMOTE ON-OFF CONTROL	By electrical signal or dry contact ON:short OFF:open			
	REMOTE SENSE	Compensate voltage drop on the load wiring up to 0.5V			
	OUTPUT VOLTAGE PROGRAMMABLE	Adjustment of output voltage is allowable to 90 ~ 110% of nominal output voltage. Please refer to the Function Manual.			
	DC OK SIGNAL	The isolated TTL signal out, Please refer to the Installation Manual			
	AC OK SIGNAL	The isolated TTL signal out, Please refer to the Installation Manual			
	OVER TEMP WARNING	Logic " High" for over temperature warning, Please refer to the Installation Manual, isolated signal			
ENVIRONMENT	WORKING TEMP.	-20 ~ +60°C (Refer to "Derating Curve")			
	WORKING HUMIDITY	20 ~ 90% RH non-condensing			
	STORAGE TEMP., HUMIDITY	-40 ~ +85°C, 10 ~ 95% RH non-condensing			
	TEMP. COEFFICIENT	±0.02%/°C (0 ~ 50°C)			
	VIBRATION	10 ~ 500Hz, 2G 10min./1cycle, 60min. each along X, Y, Z axes			
SAFETY & EMC (Note 5)	SAFETY STANDARDS	UL60950-1, TUV EN60950-1, EAC TP TC 004 approved			
	WITHSTAND VOLTAGE	I/P-O/P:3KVAC I/P-FG:2KVAC O/P-FG:0.7KVDC			
	ISOLATION RESISTANCE	I/P-O/P, I/P-FG, O/P-FG:100M Ohms / 500VDC / 25°C / 70% RH			
	EMC EMISSION	Parameter	Standard	Test Level / Note	
		Conducted	EN55032 (CISPR32) / EN55011 (CISPR11)	Class B	
		Radiated	EN55032 (CISPR32) / EN55011 (CISPR11)	Class B	
		Harmonic Current	EN61000-3-2	-----	
		Voltage Flicker	EN61000-3-3	-----	
	EMC IMMUNITY	EN55024, EN61204-3, EN61000-6-2			
		Parameter	Standard	Test Level / Note	
		ESD	EN61000-4-2	Level 3, 8KV air ; Level 2, 4KV contact	
		Radiated	EN61000-4-3	Level 3	
		EFT / Burst	EN61000-4-4	Level 3	
		Surge	EN61000-4-5	Level 4, 4KV/Line-Earth ; Level 3, 2KV/Line-Line	
		Conducted	EN61000-4-6	Level 3	
Magnetic Field		EN61000-4-8	Level 4		
Voltage Dips and Interruptions	EN61000-4-11	>95% dip 0.5 periods, 30% dip 25 periods, >95% interruptions 250 periods			
OTHERS	MTBF	274K hrs min. Telcordia SR-332 (Bellcore) ; 107.3K hrs min. MIL-HDBK-217F (25°C)			
	DIMENSION	295*127*41mm (L*W*H)			
	PACKING	1.93Kg; 6pcs/12.6Kg/1.04CUFT			
NOTE	<p>1. All parameters NOT specially mentioned are measured at 230VAC input, rated load and 25°C of ambient temperature.</p> <p>2. Ripple & noise are measured at 20MHz of bandwidth by using a 12" twisted pair-wire terminated with a 0.1uf & 47uf parallel capacitor.</p> <p>3. Tolerance : includes set up tolerance, line regulation and load regulation.</p> <p>4. Derating may be needed under low input voltages. Please check the derating curve for more details.</p> <p>5. The power supply is considered a component which will be installed into a final equipment. All the EMC tests are been executed by mounting the unit on a 720mm*360mm metal plate with 1mm of thickness. The final equipment must be re-confirmed that it still meets EMC directives. For guidance on how to perform these EMC tests, please refer to "EMI testing of component power supplies." (as available on http://www.meanwell.com)</p> <p>6. The ambient temperature derating of 3.5°C/1000m with fanless models and of 5°C/1000m with fan models for operating altitude higher than 2000m(6500ft).</p>				

Block Diagram

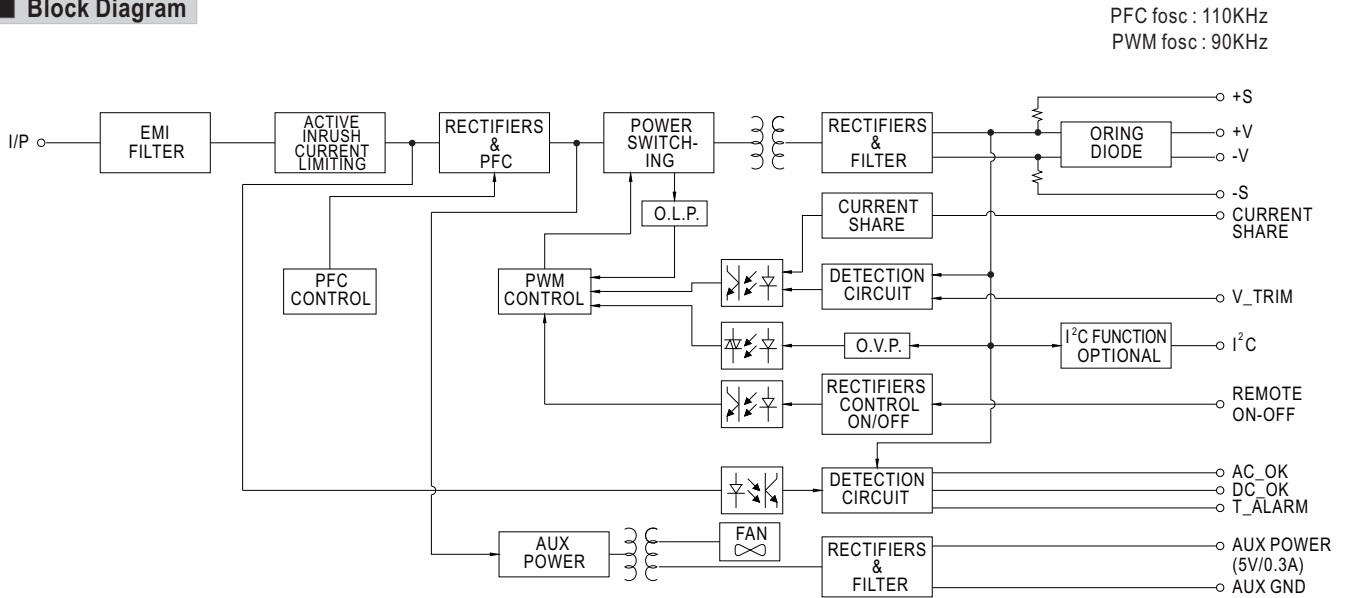

Static Characteristics

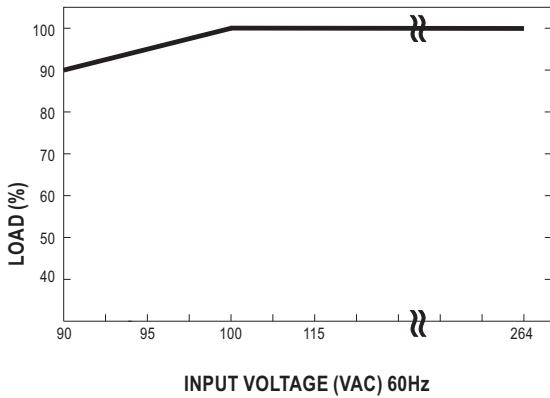

INPUT	MODEL	12V	24V	48V
180~264VAC		720W 60A	960W 40A	1008W 21A
		720W 60A	960W 40A	1008W 21A
115VAC		720W 60A	960W 40A	1008W 21A
100VAC		720W 60A	960W 40A	1008W 21A
90VAC		648W 54A	864W 36A	907.2W 18.9A

Derating Curve

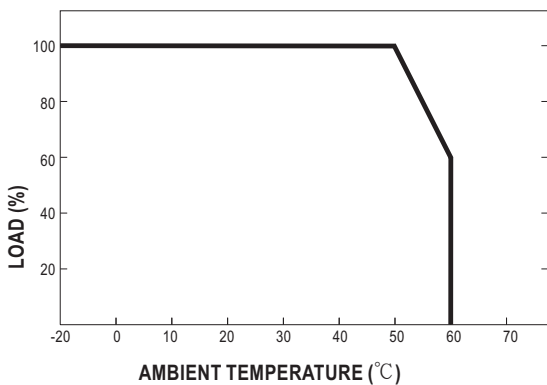

Efficiency vs Load (48V Model)

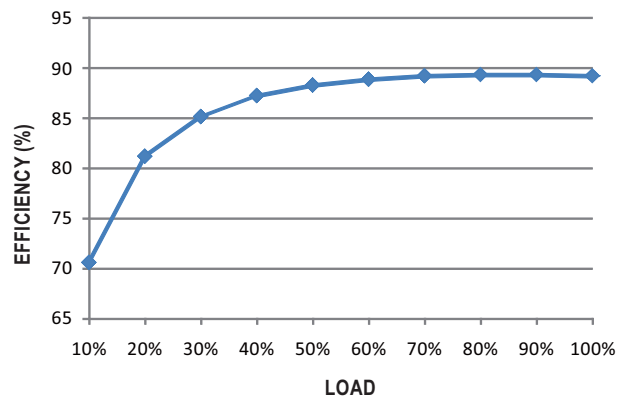

© The curve above is measured at 230VAC.

Function Manual

1. Voltage Drop Compensation

1.1 Remote Sense

The remote sense compensates voltage drop on the load wiring up to 0.5V.

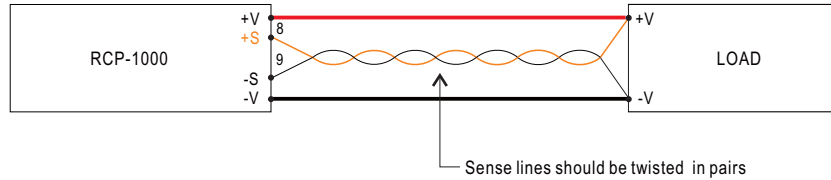

1.2 Local Sense

※ The +S,-S have to be connected to the +V,-V, respectively, as the following diagram, in order to get the correct output voltage if Remote Sense is not used.

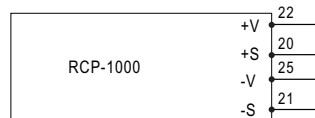

2. Remote ON/OFF Control

The power supply can be turned ON/OFF together or separately by using the "Remote ON-OFF" function.

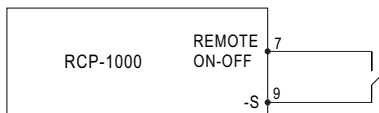

Between Remote ON-OFF and -S	Power Supply Status
Switch Short	ON
Switch Open	OFF

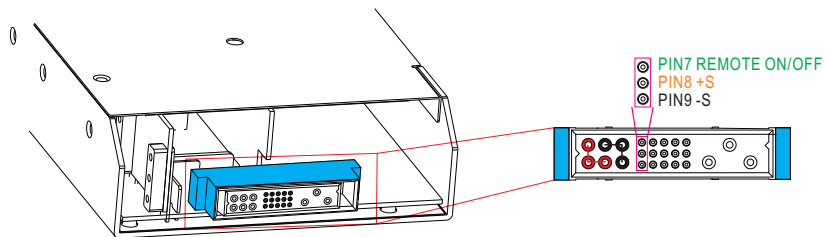

3. Output Voltage Programming (or, PV / remote voltage programming / remote adjust / margin programming / dynamic voltage trim)

※ In addition to the adjustment via the built-in potentiometer, the output voltage can be trimmed to 90~110% of the nominal voltage by applying EXTERNAL RESISTANCE.

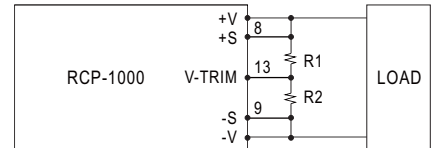
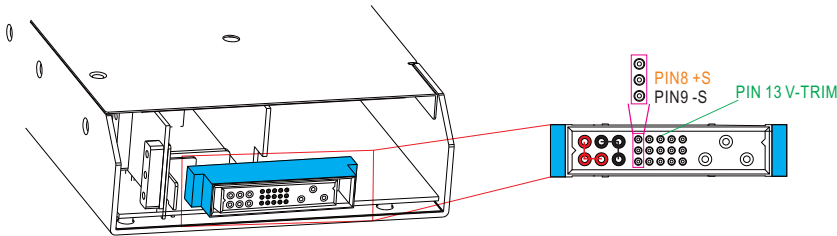

◎ +S & +V, -S & -V also need to be connected on CN501

3.1 RCP-1000-12

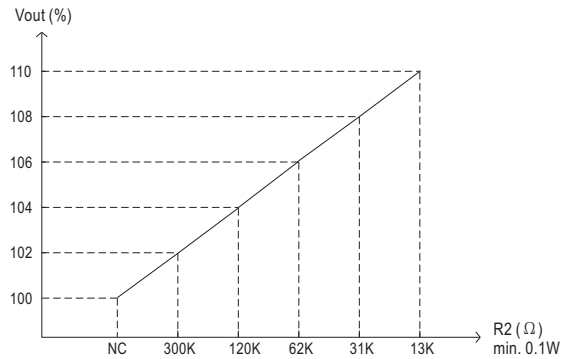
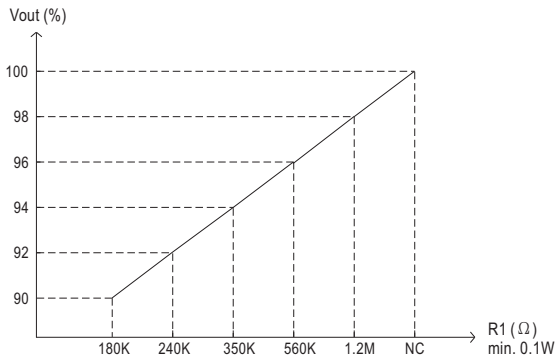

3.2 RCP-1000-24

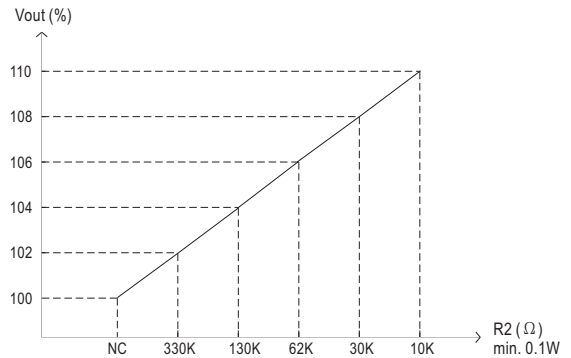
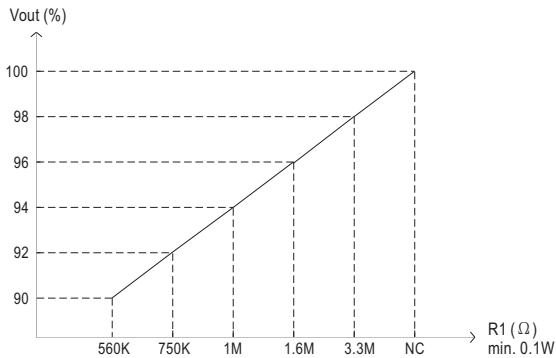

3.3 RCP-1000-48

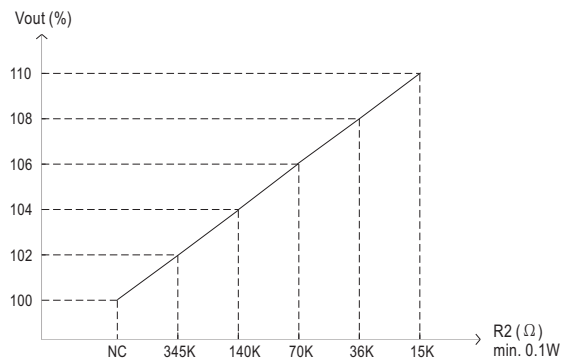
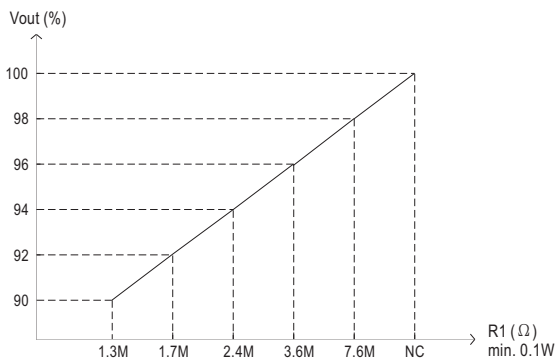

4. I²C Bus Interface Option

※ For the details of I²C option, please refer to the Installation Manual.

Mechanical Specification

Case No. 952A Unit:mm

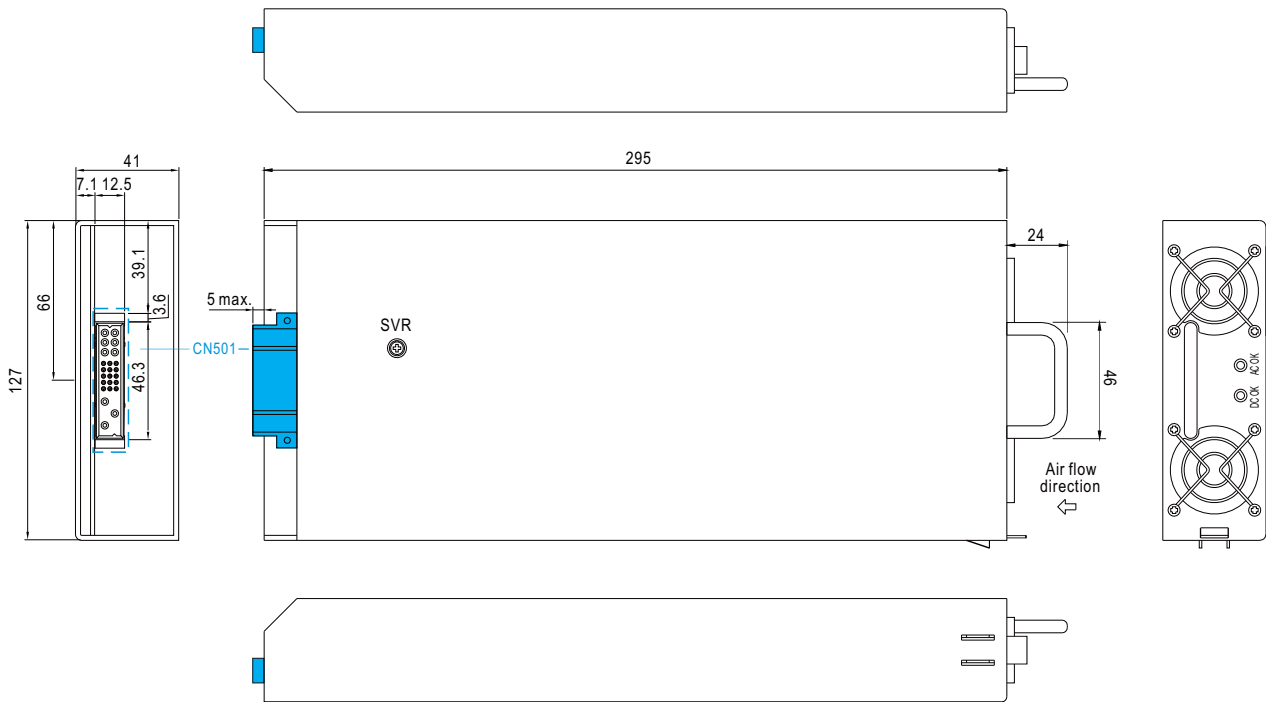

※ LED Status Indicators & Corresponding Signal at Function Pins

Function	LED	Description	* Signal	PSU Output
AC-OK	ON	When input voltage $\geq 82V \pm 4V$	0 ~ 0.5V	ON
AC-NG	OFF	When input voltage $\leq 82V \pm 4V$	4.5 ~ 5.5V	OFF
DC-OK	ON	When output voltage $\geq 80\% \pm 5\%$ of V_o rated.	0 ~ 0.5V	ON
DC-NG	OFF	When output voltage $\leq 80\% \pm 5\%$ of V_o rated.	4.5 ~ 5.5V	ON
T-OK	----	When the internal temperature (TSW1 & TSW2 short) is within safe limit	0 ~ 0.5V	ON
T-ALARM	----	When the internal temperature (TSW1 or TSW2 open) exceeds the limit of temperature alarm	4.5 ~ 5.5V	OFF

*Signal between function pin and "-V".

※ Input / Output Connector Pin No. Assignment(CN501) : Postronic PCB24W9M400A1

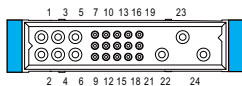

Mating Housing Postronic PCB24W9F400A1

Pin No.	Function	Description
1,2,4	+V(signal)	Positive output voltage.
3,5,6	-V(signal)	Negative output voltage.
7	RemoteON-OFF	Each unit can separately turn the output on and off by electrical or dry contact . Short: ON, Open:OFF.
8	+S	Positive sensing for Remote Sense.
9	-S	Negative sensing for Remote Sense.
10	AC-OK	Low : When input voltage is $\geq 82V_{rms} \pm 4V$. (Note.1) High : When input voltage in $\leq 82V_{rms} \pm 4V$.
11	DC-OK	High : When $V_{out} \leq 80\% \pm 5\%$. (Note.1) Low : When $V_{out} \geq 80\% \pm 5\%$
12	CS	Current sharing signal. When units are connected in parallel, the CS pins of the units should be connected to allow current balance between units.
13	V-TRIM	Connection for output voltage programming.
14	T-ALARM	High : When the internal temperature is within safe limit. (Note.1) Low : 10°C below the thermal shut down limit.
15	+5V-AUX	Auxiliary voltage output, 4.3~5.3V, referenced to GND-AUX(pin 7). The maximum load current is 0.3A. This output has the built-in "Oring diodes" and is not controlled by the remote ON/OFF control.
16	GND-AUX	Auxiliary voltage output GND. The signal return is isolated from the output terminals (+V & -V).
17	SCL	Serial clock used in the I ² C interface option. Refer to the Instruction Manual. (Note.1)
18	SDA	Serial data used in the I ² C interface option. Refer to the Instruction Manual. (Note.1)
19,20,21	A0,A1,A2	I ² C interface address lines. Refer to the Instruction Manual.
22	FG	AC Ground connection.
23	AC/L	AC Line connection.
24	AC/N	AC Neutral connection.

Note1: Non-isolated signal, referenced to the output terminal -V.