

PLEASE CHECK WWW.MOLEX.COM FOR LATEST PART INFORMATION

Part Number: [0559172010](#)
Status: **Active**
Overview: MicroClasp™ Wire-to-Board System
Description: 2.00mm Pitch MicroClasp™ Wire-to-Board Header, Dual Row, Vertical, 20 Circuits, with PCB Locator

Documents:

[3D Model](#) [Product Specification PS-51353-003-001 \(PDF\)](#)
[Drawing \(PDF\)](#) [RoHS Certificate of Compliance \(PDF\)](#)

Agency Certification

UL E29179

General

Product Family PCB Headers
 Series [55917](#)
 Application Signal, Wire-to-Board
 Overview [MicroClasp™ Wire-to-Board System](#)
 Product Name MicroClasp™
 UPC 756054244289

Physical

Breakaway No
 Circuits (Loaded) 20
 Circuits (maximum) 20
 Color - Resin Natural
 Durability (mating cycles max) 30
 First Mate / Last Break No
 Flammability 94V-0
 Glow-Wire Compliant No
 Guide to Mating Part No
 Keying to Mating Part None
 Lock to Mating Part Yes
 Material - Plating Mating Tin
 Material - Plating Termination Tin
 Material - Resin Polyester
 Net Weight 1518.800/mg
 Number of Rows 2
 Orientation Vertical
 PC Tail Length 3.20mm
 PCB Locator Yes
 PCB Retention Yes
 PCB Thickness - Recommended 1.60mm
 Packaging Type Tray
 Pitch - Mating Interface 2.00mm
 Shrouded Fully
 Stackable No
 Surface Mount Compatible (SMC) No
 Temperature Range - Operating -25°C to +85°C
 Termination Interface: Style Through Hole

Electrical

Current - Maximum per Contact 3.0A
 Voltage - Maximum 250V

Material Info

Reference - Drawing Numbers

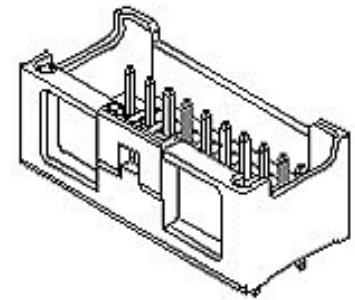

Series image - Reference only

EU ELV

Not Relevant

EU RoHS

Compliant

China RoHS

REACH SVHC

Not Contained Per
 -ED/01/2017 (12
 January 2017)

Halogen-Free

Status

Not Low-Halogen

Need more information on product environmental compliance?

Email productcompliance@molex.com
 Please visit the [Contact Us](#) section for any non-product compliance questions.

China ROHS

Green Image

ELV

Not Relevant

RoHS Phthalates

Not Contained

Search Parts in this Series

[55917 Series](#)

Mates With

[51353 MicroClasp™ Wire-to-Board Receptacle Housing](#)

This document was generated on 07/25/2017

PLEASE CHECK WWW.MOLEX.COM FOR LATEST PART INFORMATION