

PART NUMBER		SSL-LX5093UWC/G	REV	D
REV	E.C.N. NUMBER AND REVISION COMMENTS		DATE	
A	E.C.N. #11283.		01.06.06	
B	E.C.N. #11148.		10.27.06	
C	E.C.N #10BRDR. & REDRAWN.		10.10.12	
D	ECN-Lumex201800057		07.06.18	

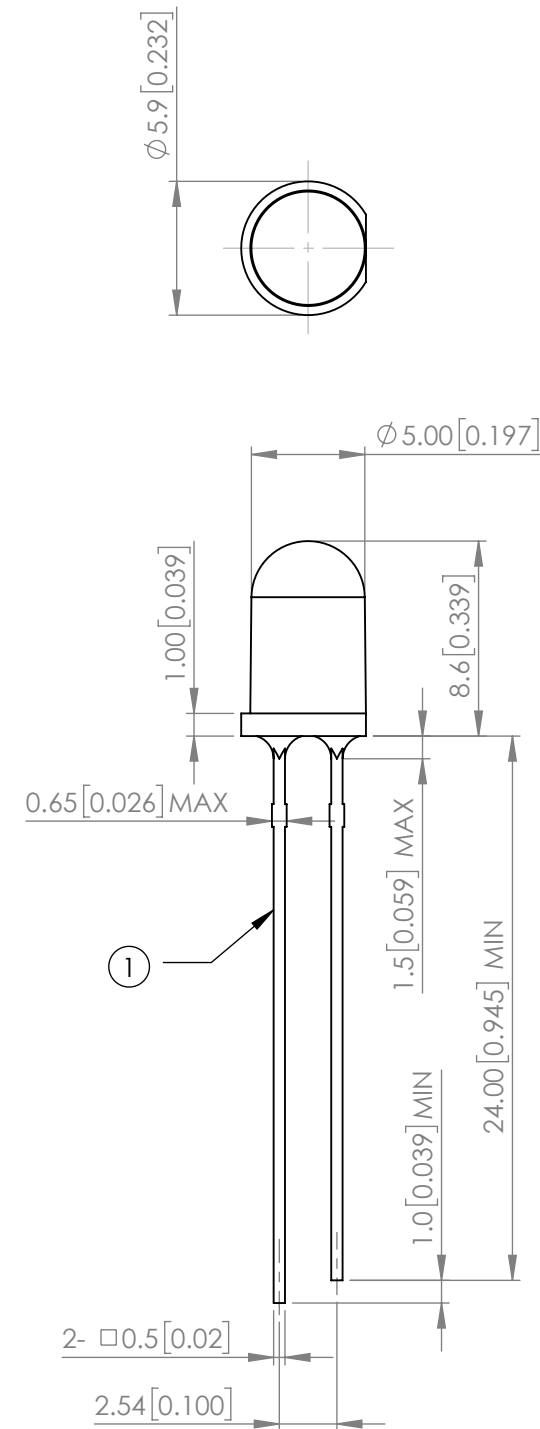

POLARITY

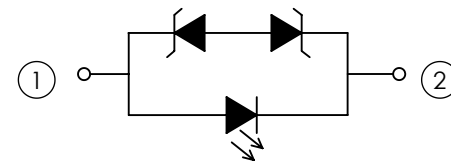

ELECTRO-OPTICAL CHARACTERISTIC TA=25°C

PARAMETER	MIN	TYP	MAX	UNITS	TEST COND
CHROMATICITY COORDINATES	X	-	0.29	-	-
	Y	-	0.28	-	-
FORWARD VOLTAGE	-	3.5	4.0	Vf	If=20mA
REVERSE CURRENT	-	-	50	uA	VR=5V
LUMINOUS INTENSITY	14250	-	28500	mcd	If=20mA
VIEWING ANGLE	-	20	-	2x theta1/2	If=20mA
EMITTED COLOR	WHITE				
EPOXY LENS FINISH	WATER CLEAR				

ABSOLUTE MAXIMUM RATINGS TA=25°C

PARAMETER	MAX	UNITS
PEAK FORWARD CURRENT*	100	mA
FORWARD CURRENT	30	mA
REVERSE VOLTAGE	5	V
POWER DISSIPATION	120	mW
STORAGE TEMPERATURE	-40 TO +100	°C
OPERATING TEMPERATURE	-40 TO +85	°C
SOLDERING TEMPERATURE**	3 SEC. MAX. @260	°C

*t<10us

**2.0mm FROM BODY

NOTE:

1. RoHS COMPLIANT.
2. COMPLIANCE WITH EU REACH.
3. COMPLIANCE Halogen FREE.
(Br < 900ppm, Cl < 900ppm, Br+ Cl < 1500ppm)

STATIC DEVICE FOLLOW PROPER E.S.D. HANDLING PROCEDURES WHEN WORKING WITH THIS PART

*UNLESS OTHERWISE SPECIFIED TOLERANCES PER DECIMAL PRECISION ARE: X=±1 (±0.039), X.X=±0.5 (±0.020), X.XX=±0.25 (±0.010), X.XXX=±0.127 (±0.005). LEAD SIZE=±0.05 (±0.002), LEAD LENGTH=±0.75 (±0.030). MIN= ^{+DECIMAL PRECISION}/_{-0.00} MAX= ^{+0.00}/_{-DECIMAL PRECISION}