

M Series Sensor Connector

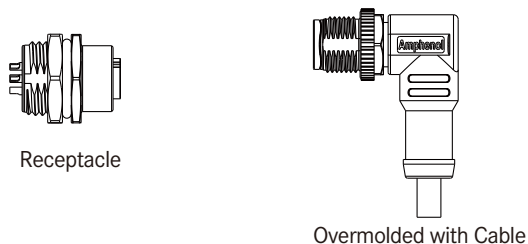

Range Overview

Receptacle to Overmolded with Cable

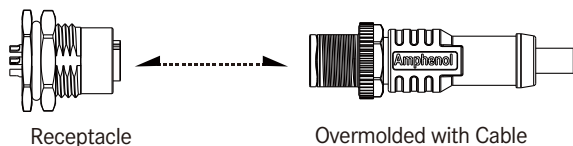

Receptacle to Field Installable

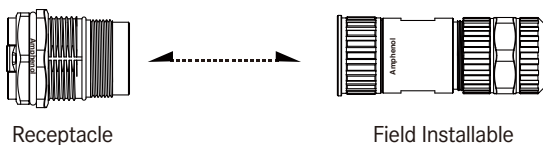
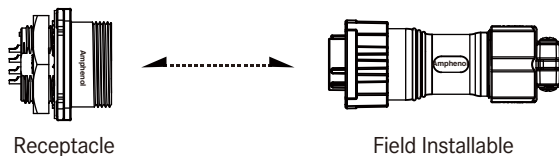
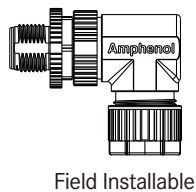
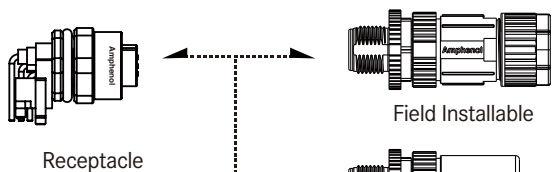

In Line

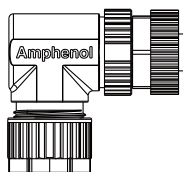
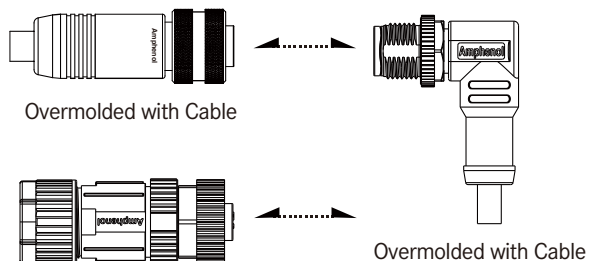
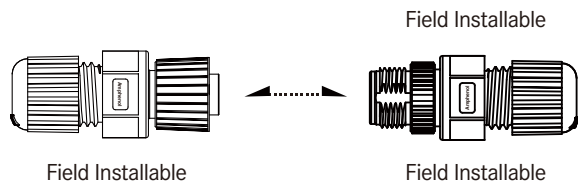
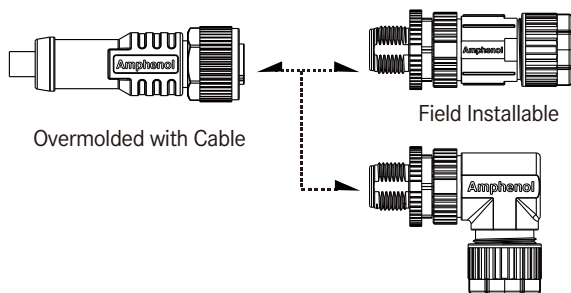
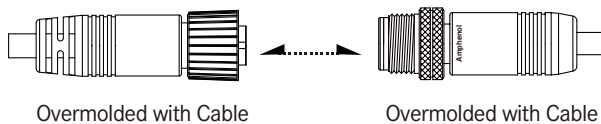

Distribution Box

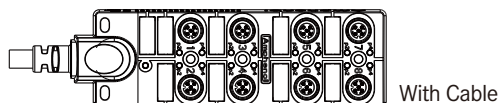

Others

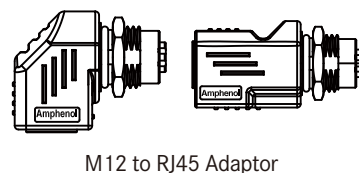
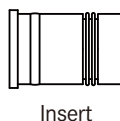

Specification | M Sensor Connector

Identifications	M8, M10.5, M12 (A, B, D, S, T, X code), Heavy Duty Shielded Connector, M23
Description	Receptacle Overmolded with Cable Field Installable
Current Rating / Data	1.5A~28A
Operating Voltage	2~4 Pins : 250V 5 Pins : 60V 6 ~12 Pins : 30V
Contact Resistance	≤ 10mΩ
Voltage Proof	3 ~ 4 Pins : 1.4 KVrms 5 Pins : 1.0 KVrms 6 ~8 Pins : 0.65 KVrms
Waterproof Rating	IP65, IP67~68
Temperature Range	Receptacle: -40°C~105°C Overmolded with Cable: PVC Cable: -20°C~80°C PU Cable: -20°C~85°C Field Installable: -40°C~105°C * Higer working temperature upon request.
Mating Cycle	100* Minimum
Vibration	10 ~ 500 Hz and 0.35 mm
Material	Contacts: Copper Alloy, Gold Plated Connector Body (Housing) : Nylon+GF or PU, UL Recognized Shield: Zinc Alloy or Copper Ally, Nickel Plated
Standard Cable Length	01~99M
Standards	IEC 61076-2-101 IEC 61076-2-104

* Design and specification are subject to change without notice.

Specification | Sensor Passive Distribution Box

Identifications	M8 Distribution Box M12 Distribution Box
Description	With Cable With Homerun Connector
Current Load Per Port	M8 Distribution Box: 2A (Max.) M12 Distribution Box: 4A (Max.)
Current Sum max.	M8 Distribution Box: 6A (Max.) M12 Distribution Box: 12A (Max.)
Operating Voltage	24V DC Nominal (10~30V)
Contact Resistance	<10mΩ
Switching Output	PNP
Power Indicator	LED, Green
Function Indicator	LED, Green
Waterproof Rating	M8 Distribution Box: IP 67 Unmated M12 Distribution Box: IP 67 Mated
Temperature Range	With Cable: -20 °C ~ 80°C With Homerun Connector: -25 °C ~ 90°C
Vibration	10 to 500 Hz and 0.35mm
Material	Conn. Housing: PA66 Box: PBT+PC Contacts: Copper Alloy, Gold Plated O-ring: Silicone Shell: Zinc Die Cast, Nickel Plated
Standard Cable Length	5M, 10M, 15M, 20M & 30M
Standards	IEC 61076-2-101

Ordering Information

	1	2	3	4	5	6	7	8	9	10
Specification / Size										
> <u>M8 Size</u>										
(8) M8	≥ M10.5 Size									
(8P) M8, Plastic	(105) M10.5									
(M8S) M8, Shielded										
> <u>M8 Size with Key, Guided M8</u>	≥ M23 Size									
(8A) M8 with Key	(LJ23) Shielded, Salt Spray Test 48H, 28A									
(8AP) M8 with Key, Plastic										
(8H) M8 with Key, Power (3A) +Data (1.5A)	≥ Heavy Duty Shielded Connector (HDSC)									
(8HP) M8 with Key, Plastic, Power (3A) +Data (1.5A)	(HB20) Shielded, Salt Spray Test 500H, 10A									
(M8AS) M8 with Key, Shielded	(LB20) Shielded, Salt Spray Test 48H, 10A									
	(HC20) Shielded, Salt Spray Test 500H, 20A									
	(LC20) Shielded, Salt Spray Test 48H, 20A									
	(HD20) Shielded, Salt Spray Test 500H, 5A									
	(LD20) Shielded, Salt Spray Test 48H, 5A									
Number of Contacts										
02, 03....., 14...Contacts										
EX. (02) = 2 Contacts										
Connector Body (Style)										
> <u>For Receptacle</u>	> <u>For Overmolded with Cable</u>					> <u>For Field Installable</u>				
(P) Panel	(A) With Strain Relief					(B) Without Strain Relief				
	(B) Without Strain Relief									
Connector (Housing) Gender										
(M) Male Connector	(F) Female Connector									
Contact Gender										
(M) Male	(F) Female					(I) I style (Male+Female)				
Assemble Style										
> <u>For Receptacle</u>	> <u>For Overmolded with Cable</u>					> <u>For Field Installable</u>				
(S) Solder Type	(M) Overmolded with Cable					(A) Solder Type				
(P) 180° PCB Type						(B) Screw Type				
(R) 90° PCB Type						(C) Crimp Type				
(C) Crimp Type						(D) IDC Type				
Mating Style										
(S) Screw Thread	(Q) Quick									
Backshell										
> <u>For Receptacle</u>	> <u>For Overmolded with Cable</u>					> <u>For Field installable</u>				
(C) Circular, Rear Fastened	(L) Straight					(L) Straight				
(F) Hexagonal, Front Fastened	(R) Right Angle					(R) Right Angle				
(H) Hexagonal, Rear Fastened										
(N) Square, Rear Fastened with Nut										
(W) Square, Front Fastened with Screw										
Waterproof Rating										
(5) IP65 (Quick Type)										
(7) IP 67										
(8) IP 68										
More Information										
> <u>For Receptacle</u>	> <u>For Receptacle with Wire Harness</u>			> <u>For Overmolded with Cable</u>			> <u>For Field Installable</u>			
(001), (002), (003).....	(□)+(■) : Cable Type + Wire Length			(□)+(■) : Cable Type + Cable Length			(001), (002), (003).....			
For Different Versions	EX. (A15) = UL 1007 Cable + 150mm			EX. (A01) = UL2464 Cable + 1M			For Different Versions			
	(□) : Cable Type			(■) : Wire Length			(□) : Cable Type		(■) : Cable Length	
	(A) UL 1007 Cable (For M8)			(15) 150mm			(A) PVC UL2464 Cable		From 1M to 99M	
				(30) 300mm			(B) PU VW-1 Cable		EX. (01) = 1M	
				(50) 500mm						
				(A0) 1000mm						
				(A5) 1500mm						

* Design and specification are subject to change without notice.

Ordering Information

	1	2	3	4	5	6	7	8	9	10	
Specification / Size											
<u>> A-Coded</u>											
(M12A) M12 A-Coded	<u>> S-Coded</u>										
(MSAP) M12 A-Coded, Plastic	(M12S) M12 S-Coded										
(MSAS) M12 A-Coded, Shielded	(MSSP) M12 S-Coded, Plastic										
<u>> B-Coded</u>											
(M12B) M12 B-Coded	<u>> T-Coded</u>										
(MSBP) M12 B-Coded, Plastic	(M12T) M12 T-Coded										
(MSBS) M12 B-Coded, Shielded	(MSTP) M12 T-Coded, Plastic										
<u>> D-Coded</u>											
(M12D) M12 D-Coded	<u>> X-Coded</u>										
(MSDP) M12 D-Coded, Plastic	(MSXS) M12 X-Coded, Shielded										
(MSDS) M12 D-Coded, Shielded											
Number of Contacts											
02, 03....., 14...Contacts											
EX. (02) = 2 Contacts											
Connector Body (Style)											
<u>> For Receptacle</u>											
(P) Panel	<u>> For Overmolded with Cable</u>		<u>> For Field installable</u>								
	(A) With Strain Relief	(B) Without Strain Relief	(A) With Strain Relief								
			(B) Without Strain Relief								
Connector (Housing) Gender											
(M) Male Connector	(F) Female Connector										
Contact Gender											
(M) Male	(F) Female	(I) I style (Male+Female)									
Assemble Style											
<u>> For Receptacle</u>											
(S) Solder Type	<u>> For Field Installable</u>		<u>> For Overmolded with Cable</u>								
(P) 180° PCB Type	(A) Solder Type	(M) Overmolded with Cable									
(R) 90° PCB Type	(B) Screw Type										
(C) Crimp Type	(C) Crimp Type										
	(D) IDC Type										
Mating Style											
(S) Screw Thread	(Q) Quick										
Backshell											
<u>> For Receptacle</u>											
(C) Circular, Rear Fastened	<u>> For Overmolded with Cable</u>		<u>> For Field Installable</u>								
(F) Hexagonal, Front Fastened	(L) Straight	(L) Straight									
(H) Hexagonal, Rear Fastened	(R) Right Angle	(R) Right Angle									
(N) Square, Rear Fastened with Nut											
(W) Square, Front Fastened with Screw											
Waterproof Rating											
(5) IP65 (Quick Type)											
(7) IP 67											
(8) IP 68											
Cable information											
<u>> For Receptacle</u>											
(001) PG9	<u>> For Receptacle with Wire Harness</u>		<u>> For Overmolded with Cable</u>				<u>> For Field Installable</u>				
(002) M16	(□)+(■) : Wire Type + Wire Length		(□)+(■) : Cable Type + Cable Length				(001), (002), (003).....				
(003) M12	EX. (B15) = UL1061 + 150mm		EX. (A01) = PVC UL2517 Yellow Cable + 1M				For Different Versions				
	(□) : Wire Type		(■) : Cable Length		(□) : Cable Type		(■) : Cable Length				
	(B) UL1061 (For M12-PG9)	(15) 150mm	(A) PVC UL2517 Yellow Cable	From 1M to 99M							
	(C) UL1061 (For M12-M16)	(30) 300mm	(B) PU UL20549 Cable	EX. (01) = 1M							
		(50) 500mm	(C) CAN Cable								
		(A0) 1000	(D) PVC UL2517 Black Cable								
		(A5) 1500	(E) Cate 5E Cable(2Pair/4Pair)								
			(F) F-PVC UL2095 Black Cable								
			(G) PVC UL 21996, Balck, round cable								
			(H) PVC UL 21996, Balck, oval cable								
			(S) AC 630V Cable								
			(T) DC 60V Cable								
			(X) Cate 6A Cable								

Ordering Information

Specification / Size

> With M8 Connectors

(DB8) M8 Connector
(DB8P) M8 Plastic Sensor Connector
(DB8S) M8 Shielded Sensor Connector

> With M12 Connectors

(DB12) M12 Sensor Connector
(DB12P) M12 Plastic Sensor Connector
(DB12S) M12 Shielded Sensor Connector

Number of Contacts

02, 03.....,14...Contacts
EX. (02) = 2 Contacts

Code

(A) A Code
(B) B Code
(C) C Code

Ports

(4) 4 Ports
(6) 6 Ports
(8) 8 Ports

Homorun Connector

(M8) M8 Connector	(M23) M23 Connector
(M12) M12 Connector	(TBK) Terminal Block
(M16) M16 Connector	(CAB) Cable

Signal Output

(0) None
(S) Single
(D) Dual

Switching Output

(0) None
(S) Single
(D) Dual

Mating Style

(L) Lock
(S) Screw
(Q) Quick

Waterproof Rating

(5) IP 65 (Quick Type)	(7) IP 67
(6) IP 66	(8) IP 68

For More Information

> Without Cable

(001), (002), (003).....
For Different Versions

> With Cable

+ : Cable Type + Cable Length
EX. (A01) = PVC UL2517 Cable + 1M

<input type="checkbox"/> : Cable Type	<input type="checkbox"/> : Cable Length
(A) PVC UL2517 Cable	From 1M to 99M
(B) PU 20549 Cable	EX. (01) = 1M
(C) Hi-Flex Cable	
(D) DeviceNet / NMEA	
(E) Ethernet	
(F) ProfiBus	
(P) ProfiNet	

Physical Dimension

Receptacle

Panel Cut-Out

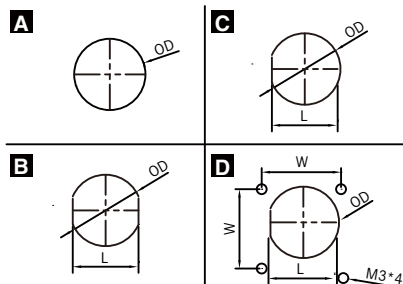

Size		Dimension			Type	L / W	OD
Size	Thread Description	Female			Male		
M105	M10.5 X 0.75	-	-	-	A	-	10.9
M8	M8 X 1.0	B	7.1	8.1	B	7.1	8.1
		-	-	-	A	-	8.1
M12	M12 X 1.0 - PG9	B	13.6	15.4	B	13.6	15.4
	M12 X 1.0 - M16.0 X 1.5	B	13.6	16.1	B	13.6	16.1
	M12.0 X 1.0	B	10.5	12.2	B	10.5	12.2
HDSC*	M22 X 1.0	-	-	-	C	19.2	20.2
		-	-	-	D	19.2 / 23.0	20.2
M23	M23 X 1.0	-	-	-	C	24.4	25.1

*HDSC: Heavy Duty Shielded Connector

Connector Dimension

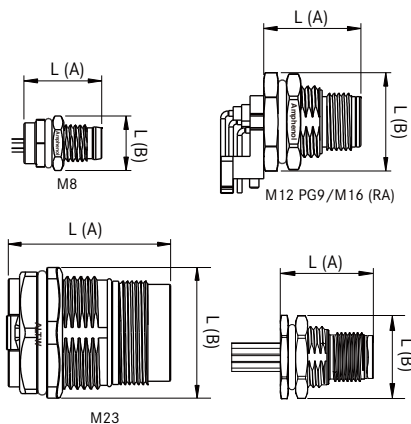

Series	Receptacle				Panel Thickness		
	Type	Female		Male		Front Fastened	Rear Fastened
L (A)		L (B)	L (A)	L (B)			
M8	Straight	18.0	13.8	16.4	11.5	3.0 mm Max.	3.5 mm Max.
M105	Straight	-	-	18.0	15.0	-	6.0 mm Max.
M12	Straight	20.0	20.6	23.0	20.6	4.5mm Max. 4.0mm Max.(Plastic)	4.5mm Max.
	Right Angle	20.0	20.8	20.5	20.8		
	M12* 1.0	Right Angle	16.9	15.0	16.2	15.0	3.0mm Max.
HDSC*	Straight	-	-	23.5	29.0	9.0mm Min.	5.0 mm Max.
M23	Straight	-	-	36.0	29.0	6.0 mm Max.	-

*HDSC: Heavy Duty Shielded Connector

Overmolded with Cable

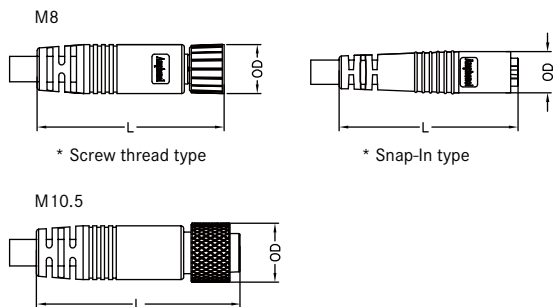

Size		Dimension		L		OD	
Size	Type	Female	Male	Female	Male	Female	Male
M8	Screw Thread M8 X 1.0	38.1	42.7	10.1	10.5	-	-
M8	Snap-In M8 X 1.0	36.5	-	8.4	-	-	-
M105	Screw Thread M10.5 X 0.75	37.2	-	12.0	-	-	-

* Design and specification are subject to change without notice.

Physical Dimension

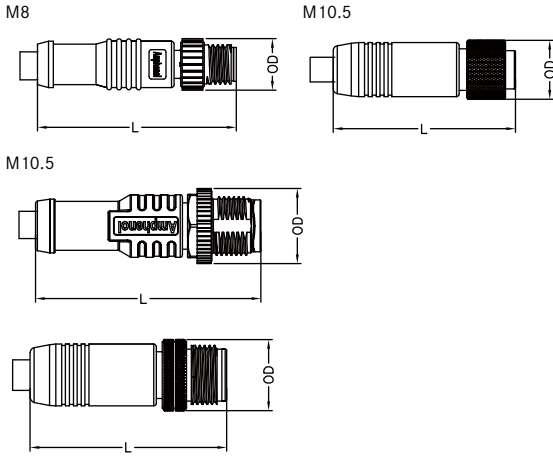

Size \ Dimension		L		OD	
Size	Type	Female	Male	Female	Male
M8	Screw Thread M8 X 1.0	36.0	40.5	10.1	10.5
M10.5	Screw Thread M10.5 X 0.75	37.2	-	12.0	-
M12	Screw Thread M12.0 X 1.0	37.2	-	12.0	-
M12 Shielded	Screw Thread M12.0 X 1.0	39.2	40.1	14.5	14.5

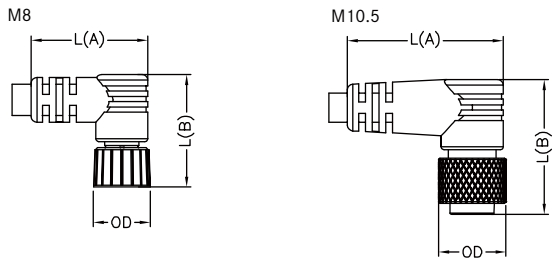

Size \ Dimension		L [A]		L [B]		OD	
Size	Thread Description	Female	Male	Female	Male	Female	Male
M8	M8 X 1.0	24.0	-	24.0	-	12.0	-
M10.5	Screw Thread M10.5 X 0.75	20.7	20.7	20.0	25.5	10.1	10.5

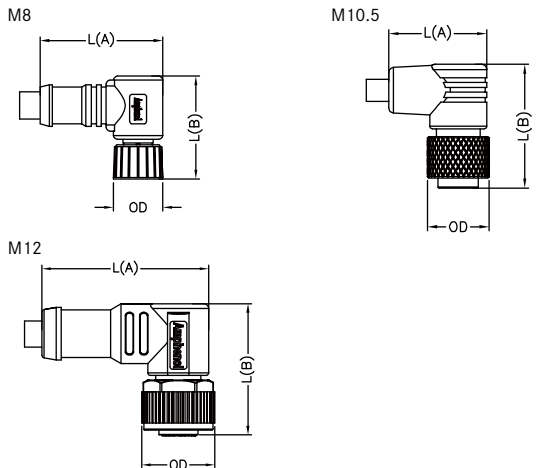

Size \ Dimension		L [A]		L [B]		OD	
Size	Thread Description	Female	Male	Female	Male	Female	Male
M8	M8 X 1.0	24.0	-	24.0	-	12.0	-
M10.5	Screw Thread M10.5 X 0.75	20.7	20.7	20.0	25.5	10.1	10.5

Field Installable

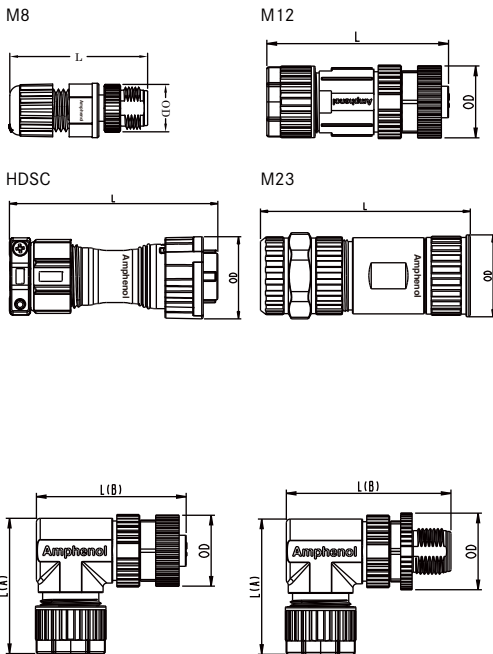

Dimension		Pin Type	L		OD	
Size	Thread Description		Female	Male	Female	Male
M8	M8 X 1.0	Screw In	55.4	59.1	16.7	16.7
M12 Metal Nut	M12 X 1.0	Solder	40.5	41.8	14.5	14.4
		Screw	47.0	51.0	18.6	20.1
		IDC	47.0	51.0	18.6	20.1
M12 Plastic	M12 X 1.0	Solder	61.3	61.3	20.8	20.8
		Screw	47.0	51.0	18.6	20.1
		IDC	47.0	51.0	18.6	20.1
M12 Shielded	M12 X 1.0	Solder	52.0	55.0	18.6	20.1
		Screw	52.0	55.0	18.6	20.1
		IDC	52.0	55.0	18.6	20.1
HDSC*	M22 X 1.0	-	72.5	-	27.7	-
M23	M23 X 1.0	-	73.0	-	28.5	-

*HDSC: Heavy Duty Shielded Connector

Dimension		Pin Type	L [A]		L [B]		OD	
Size	Thread Description		Female	Male	Female	Male	Female	Male
M12	M12.0 X 1.0	Screw In	38.9	38.9	52.3	52.3	20.8	20.8
M12 Plastic			38.9	38.9	52.3	52.3	20.8	20.8

Dimensions are shown in millimeters

* Design and specification are subject to change without notice.

Contact Configuration

	M8			M105	M12 A Code	M12 B Code	M12 D Code	M12 I Style				
	(1.5A)	(3A)		(2A)	(3~5P: 4A 8P: 2A)	(4A)	(4A)	(4A)				
④ ⑤	MM or FF	MM or FF	MM or FF	MF or FM	MM or FF	MF or FM	MM or FF	MF or FM	MM or FF	MF or FM	MM or FF	MF or FM
2Pin (02)												
		R C F		R C								
3Pin (03)												
		R C F	R C F	R C	R C F		R F		R F			
4Pin (04)												
		R C F	R C F	R C	R C F		R C F		R C F			
5Pin (05)												
	R C F			R C	R C F		R C F		R C F		R C F	
6Pin (06)												
	R C F											
7Pin (07)												
8Pin (08)												
					R C F							
10Pin (10)												
12Pin (12)												
14Pin (14)												

More to know:

No. of Poles & Contact Configuration (Connection side view)

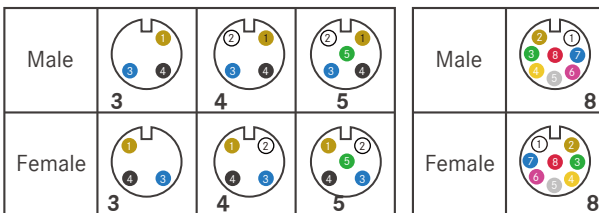

Color Identification:

1 = Brown, 2 = White, 3 = Blue, 4 = Black, 5 = Green

Color Identification:

1 = White, 2 = Brown, 3 = Green, 4 = Yellow,

5 = Gray, 6 = Pink, 7 = Blue, 8 = Red

HDSC* (5A)		HDSC* (10A)		HDSC* (20A)		M23 (28A)	
MM or FF	MF or FM	MM or FF	MF or FM	MM or FF	MF or FM	MM or FF	MF or FM
					R F		
					R F		
			R F				
			R F				
						R F	R F
			R F				
	R F						
	R F						
	R F						

*HDSC: Heavy Duty Shielded Connector

M12 Panel Version	Screw Thread Size	Logo
001	M12XPG9	With Logo
002	M12XPG9	Without Logo
003	M12XM16.0X1.5	With Logo
004	M12XM16.0X1.5	Without Logo
005	M12XM16.0X1.5	Without Logo
006	M12X1.0	With Logo
007	M12X1.0	Without Logo

* Design and specification are subject to change without notice.

R: receptacle
C: overmolded with cable
F: field installable

- 1**
- 1.5A (M8)
 - 2A (M105/M12 A)
 - 3A (M8)
 - ▲ 4A (M12 A/M12 B/M12 D/M12 I Style)
 - △ 5A (HDSC*)
 - 10A (HDSC*)
 - ◇ 20A (HDSC*)
 - 28A (M23)

2

Contact Number:
 Ex.2 contacts (02)

4

Connector (Housing) Gender:
 Male(M) or Female(F)

5

Contact Gender:
 Male(M) or Female(F)
 Male + Female (I)

6

More to Choose:

- Solder (S)
 - Solder Cup
 - PCB Type
 - 90° PCB (R) - 180° PCB (P)
- 
- 
- 

More to know:

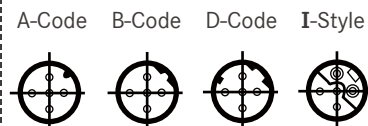

Product Features

Receptacle

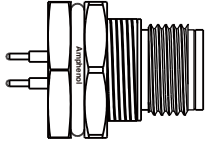

Mating Style 7



Screw Thread (S)

Backshell 8



Circular (C)



Hexagonal (H)(F)



Square (N)(W)

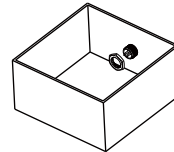

Rear Fastened

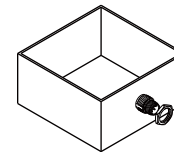

Front Fastened (P)

Overmolded with Cable

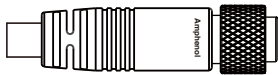

Mating Style 7



Screw Thread (S)
(For M12)



Quick (Q)
(For M8)

Backshell 8

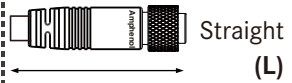

Straight (L)



Right Angle (R)

Connector Body (Style) 3



With Strain Relief (A)

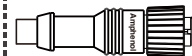

Without Strain Relief (B)

Field Installable

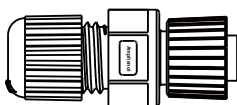

Mating Style 7



Screw Thread (S)

Backshell 8

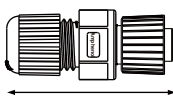

Straight (L)

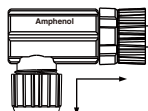

Right Angle (R)

Connector Body (Style) 3

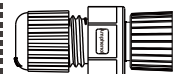

Without Strain Relief (B)

Find Our Standard Products

└ M8 (Shielded) > Receptacle > Male Connector > Front Fastened

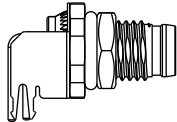
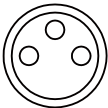
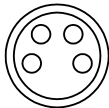
		
Backshell: Hexagonal		
Type	4A/60V	4A/30V
PCB Pin	M8S-03PMMR-SF8001	M8S-04PMMR-SF8001

└ M8 (Shielded) > Receptacle > Female Connector > Rear Fastened

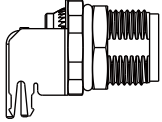
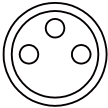
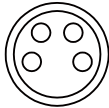
		
Backshell: Hexagonal		
Type	4A/60V	4A/30V
PCB Pin	M8S-03PFFR-SF8001	M8S-04PFFR-SF8001

* Design and specification are subject to change without notice.



M8 (Metal Nut)

Receptacle > Male / Female Connector

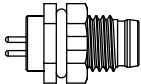
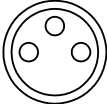

IP 65 . 67 9

Receptacle | Unmated
Overmolded with Cable | Mated
Field Installable | Mated

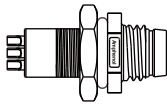
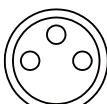

∟ **M8 (Metal Nut) > Receptacle > Male Connector > Front Fastened**

		
Backshell: Hexagonal		
Type	3A/60V	3A/30V
PCB Pin	8-03PMMP-SF7001 8-03PMMP-SF7002	8-04PMMP-SF7001 8-04PMMP-SF7002
Solder Pin	8-03PMMS-SF7001 8-03PMMS-SF7002	8-04PMMS-SF7001 8-04PMMS-SF7002

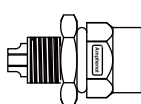

∟ **M8 (Metal Nut) > Receptacle > Male Connector > Rear Fastened**

		
Backshell: Hexagonal		
Type	3A/60V	3A/30V
PCB Pin	8-03PMMP-SH7001	8-04PMMP-SH7001
Solder Pin	8-03PMMS-SH7001 8-03PMMS-SH7002	8-04PMMS-SH7001 8-04PMMS-SH7002

∟ **M8 (Metal Nut) > Receptacle > Female Connector > Rear Fastened**

		
Backshell: Hexagonal		
Type	3A/60V	3A/30V
Solder Pin	8-03PFFS-SH7001 8-03PFFS-SH7002	8-04PFFS-SH7001 8-04PFFS-SH7002

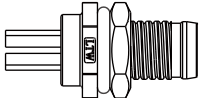
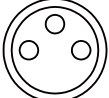
➤ **M8 (Metal Nut) > Receptacle with Wires > Male Connector > Front Fastened**

		
Backshell: Hexagonal		
Wire Length (UL1007)*	3A/60V	3A/30V
150mm	8-03PMMS-SF7A15	8-04PMMS-SF7A15
300mm	8-03PMMS-SF7A30	8-04PMMS-SF7A30
500mm	8-03PMMS-SF7A50	8-04PMMS-SF7A50
1000mm	8-03PMMS-SF7AA0	8-04PMMS-SF7AA0
1500mm	8-03PMMS-SF7AA5	8-04PMMS-SF7AA5

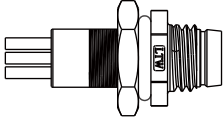
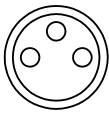
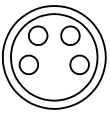

* Other wire types are available upon request

➤ **M8 (Metal Nut) > Receptacle with Wires > Male Connector > Rear Fastened**

		
Backshell: Hexagonal		
Wire Length (UL1007)*	3A/60V	3A/30V
150mm	8-03PMMS-SH7A15	8-04PMMS-SH7A15
300mm	8-03PMMS-SH7A30	8-04PMMS-SH7A30
500mm	8-03PMMS-SH7A50	8-04PMMS-SH7A50
1000mm	8-03PMMS-SH7AA0	8-04PMMS-SH7AA0
1500mm	8-03PMMS-SH7AA5	8-04PMMS-SH7AA5

* Other wire types are available upon request

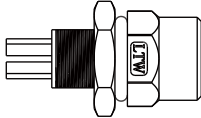
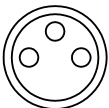
➤ **M8 (Metal Nut) > Receptacle with Wires > Female Connector > Rear Fastened**

		
Backshell: Hexagonal		
Wire Length (UL1007)*	3A/60V	3A/30V
150mm	8-03PFFS-SH7A15	8-04PFFS-SH7A15
300mm	8-03PFFS-SH7A30	8-04PFFS-SH7A30
500mm	8-03PFFS-SH7A50	8-04PFFS-SH7A50
1000mm	8-03PFFS-SH7AA0	8-04PFFS-SH7AA0
1500mm	8-03PFFS-SH7AA5	8-04PFFS-SH7AA5

* Other wire types are available upon request

M8 (Metal Nut)

Overmolded with Cable > Male / Female Connector

IP 67 . 68 9

Receptacle | Unmated
Overmolded with Cable | Mated
Field Installable | Mated

└ M8 (Metal Nut) > Overmolded with cable > Male Connector > Right Angle

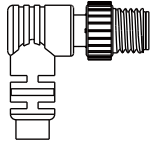
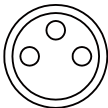
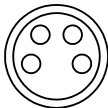
		
Type	3A/60V	3A/30V
With Strain Relief	8-03AMMM-SR7XXX*	8-04AMMM-SR7XXX*
Without Strain Relief	8-03BMMM-SR7XXX*	8-04BMMM-SR7XXX*

* XXX: Choose the cable type and length:
 - PVC: 1M (A01) / 2M (A02) / 5M (A05) / 10M (A10)
 - PU: 1M (B01) / 2M (B02) / 5M (B05) / 10M (B10)

└ M8 (Metal Nut) > Overmolded with cable > Male Connector > Straight

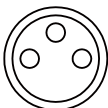
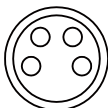
		
Type	3A/60V	3A/30V
With Strain Relief	8-03AMMM-SL7XXX*	8-04AMMM-SL7XXX*
Without Strain Relief	8-03BMMM-SL7XXX*	8-04BMMM-SL7XXX*

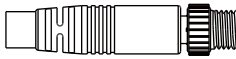
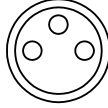
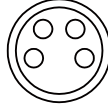

* XXX: Choose the cable type and length:
 - PVC: 1M (A01) / 2M (A02) / 5M (A05) / 10M (A10)
 - PU: 1M (B01) / 2M (B02) / 5M (B05) / 10M (B10)

└ M8 (Metal Nut) > Overmolded with cable > Female Connector > Right Angle

		
Type	3A/60V	3A/30V
With Strain Relief	8-03AFFM-SR7XXX*	8-04AFFM-SR7XXX*
Without Strain Relief	8-03BFFM-SR7XXX*	8-04BFFM-SR7XXX*

* XXX: Choose the cable type and length:
 - PVC: 1M (A01) / 2M (A02) / 5M (A05) / 10M (A10)
 - PU: 1M (B01) / 2M (B02) / 5M (B05) / 10M (B10)

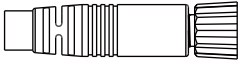
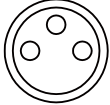
∟ **M8 (Metal Nut) > Overmolded with cable > Female Connector > Straight**

		
Type	3A/60V	3A/30V
With Strain Relief	8-03AFFM-SL77XXX*	8-03AFFM-SL77XXX*
Without Strain Relief	8-03BFFM-SL7XXX*	8-03BFFM-SL7XXX*

* XXX: Choose the cable type and length:

- PVC: 1M (A01) / 2M (A02) / 5M (A05) / 10M (A10)

- PU: 1M (B01) / 2M (B02) / 5M (B05) / 10M (B10)



M8 (Plastic)

Receptacle / Overmolded with cable > Male Connector

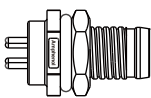
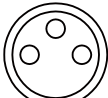

IP 67 . 68 9

Receptacle | Unmated
Overmolded with Cable | Mated
Field Installable | Mated

∟ **M8 (Plastic) > Receptacle > Male Connector > Front Fastened**

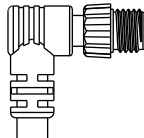
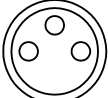

		
Type	3A/60V	3A/30V
PCB Pin	8P-03PMMP-SF7001	8P-03PMMP-SF7001
Solder Pin	8P-03PMMS-SF7001	8P-03PMMS-SF7001

∟ **M8 (Plastic) > Overmolded with cable > Male Connector > Right Angle**

		
Type	3A/60V	3A/30V
With Strain Relief	8P-03AMMM-SR7XXX*	8P-03AMMM-SR7XXX*
Without Strain Relief	8P-03BMMM-SR7XXX*	8P-03BMMM-SR7XXX*

* XXX: Choose the cable type and length:
 - PVC: 1M (A01) / 2M (A02) / 5M (A05) / 10M (A10)
 - PU: 1M (B01) / 2M (B02) / 5M (B05) / 10M (B10)

∟ **M8 (Plastic) > Overmolded with cable > Male Connector > Straight**

		
Type	3A/60V	3A/30V
With Strain Relief	8P-03AMMM-SL7XXX*	8P-03AMMM-SL7XXX*
Without Strain Relief	8P-03BMMM-SL7XXX*	8P-03BMMM-SL7XXX*

* XXX: Choose the cable type and length:
 - PVC: 1M (A01) / 2M (A02) / 5M (A05) / 10M (A10)
 - PU: 1M (B01) / 2M (B02) / 5M (B05) / 10M (B10)

∟ M8 (Plastic) > Overmolded with cable > Female Connector > Right Angle

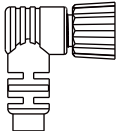
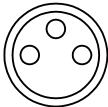
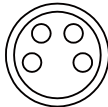
		
Type	3A/60V	3A/30V
With Strain Relief	8P-03AFFM-SR7XXX*	8P-03AFFM-SR7XXX*
Without Strain Relief	8P-03BFFM-SR7XXX*	8P-03BFFM-SR7XXX*

* XXX: Choose the cable type and length:
 - PVC: 1M (A01) / 2M (A02) / 5M (A05) / 10M (A10)
 - PU: 1M (B01) / 2M (B02) / 5M (B05) / 10M (B10)

∟ M8 (Plastic) > Overmolded with cable > Female Connector > Straight

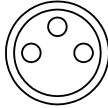
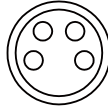
		
Type	3A/60V	3A/30V
With Strain Relief	8P-03AFFM-SL7XXX*	8P-03AFFM-SL7XXX*
Without Strain Relief	8P-03BFFM-SL7XXX*	8P-03BFFM-SL7XXX*

* XXX: Choose the cable type and length:
 - PVC: 1M (A01) / 2M (A02) / 5M (A05) / 10M (A10)
 - PU: 1M (B01) / 2M (B02) / 5M (B05) / 10M (B10)

∟ M8 (Plastic) > Overmolded with cable > Female Connector > Straight > Snap-In

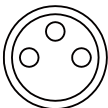
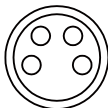
		
Type	3A/60V	3A/30V
With Strain Relief	8P-03AFFM-QL5XXX*	8P-03AFFM-QL5XXX*

* XXX: Choose the cable type and length:
 - PVC: 1M (A01) / 2M (A02) / 5M (A05) / 10M (A10)
 - PU: 1M (B01) / 2M (B02) / 5M (B05) / 10M (B10)

* Design and specification are subject to change without notice.



M8 (Plastic)

Field Installable > Male / Female Connector

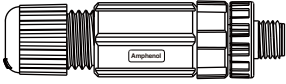
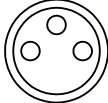

IP 67 . 68 **9**

Receptacle | Unmated
Overmolded with Cable | Mated
Field Installable | Mated





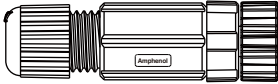
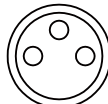

∟ **M8 (Plastic) > Field Installable > Male Connector > Straight**

			
Type	Contact Type	3A/60V	3A/30V
Without Strain Relief	Screw-in	8P-03BMMB-SL7001	8P-04BMMB-SL7001

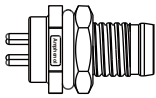



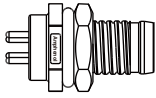

∟ **M8 (Plastic) > Field Installable > Female Connector > Straight**

			
Type	Contact Type	3A/60V	3A/30V
Without Strain Relief	Screw-in	8P-03BFFB-SL7001	8P-04BFFB-SL7001

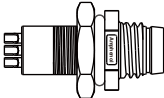
∟ **Guided M8 (G8) (Metal Nut) > Receptacle > Male Connector > Front Fastened**



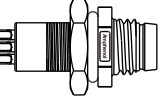



				
Backshell: Hexagonal				
Type	3A/60V	3A/60V	3A/30V	1.5A/30V
PCB Pin	8A-02PMMP-SF7001	8A-03PMMP-SF7001	8A-04PMMP-SF7001	8A-05PMMP-SF7001
Solder Pin	8A-02PMMS-SF7001	8A-03PMMS-SF7001	8A-04PMMS-SF7001	8A-05PMMS-SF7001
				
Backshell: Hexagonal		Hybrid		
Type	1.5A/30V	3A+1.5A/30V		
PCB Pin	8A-06PMMP-SF7001	8H-05PMMP-SF7001		
Solder Pin	8A-06PMMS-SF7001	8H-05PMMS-SF7001		

∟ **Guided M8 (G8) (Metal Nut) > Receptacle > Male Connector > Rear Fastened**

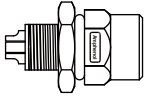



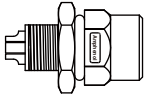

				
Backshell: Hexagonal				
Type	3A/60V	3A/60V	3A/30V	1.5A/30V
Solder Pin	8A-02PMMS-SH7001	8A-03PMMS-SH7001	8A-04PMMS-SH7001	8A-05PMMS-SH7002
				
Backshell: Hexagonal		Hybrid		
Type	1.5A/30V	3A+1.5A/30V		
Solder Pin	8A-06PMMS-SH7002	8H-05PMMS-SH7001		

* Design and specification are subject to change without notice.

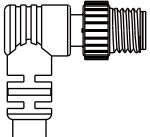
▾ Guided M8 (G8) (Metal Nut) > Receptacle > Female Connector > Rear Fastened



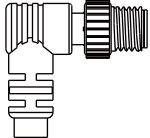



				
Backshell: Hexagonal				
Type	3A/60V	3A/60V	3A/30V	1.5A/30V
Solder Pin	8A-02PFFS-SH7001	8A-03PFFS-SH7001	8A-04PFFS-SH7001	8A-05PFFS-SH7001
				
Backshell: Hexagonal		Hybrid		
Type	1.5A/30V	3A+1.5A/30V		
Solder Pin	8A-06PFFS-SH7001	8H-05PFFS-SH7001		

▾ Guided M8 (G8) (Metal Nut) > Overmolded with cable > Male Connector > Right Angle

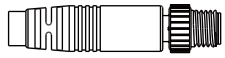

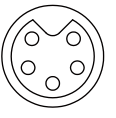
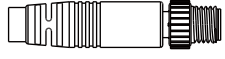
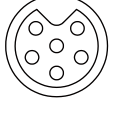

				
Type	3A/60V	3A/60V	3A/30V	1.5A/30V
Solder Pin	8A-02AMMM-SR7XXX*	8A-03AMMM-SR7XXX*	8A-04AMMM-SR7XXX*	8A-05AMMM-SR7XXX*
				
Type	1.5A/30V	3A+1.5A/30V		
Solder Pin	8A-06AMMM-SR7XXX*	8H-05AMMM-SR7XXX*		

* XXX: Choose the cable type and length:
 - PVC: 1M (A01) / 2M (A02) / 5M (A05) / 10M (A10)
 - PU: 1M (B01) / 2M (B02) / 5M (B05) / 10M (B10)

∟ **Guided M8 (G8) (Metal Nut) > Overmolded with cable > Male Connector > Straight**

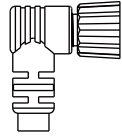



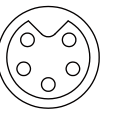
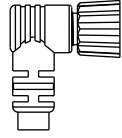
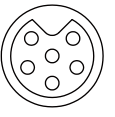
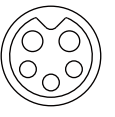



					
Type	3A/60V	3A/60V	3A/30V	1.5A/30V	
Solder Pin	8A-02AMMM-SL7XXX*	8A-03AMMM-SL7XXX*	8A-04AMMM-SL7XXX*	8A-05AMMM-SL7XXX*	
			* XXX: Choose the cable type and length: - PVC: 1M (A01) / 2M (A02) / 5M (A05) / 10M (A10) - PU: 1M (B01) / 2M (B02) / 5M (B05) / 10M (B10)		
Type	1.5A/30V	3A+1.5A/30V			Hybrid
Solder Pin	8A-06AMMM-SL7XXX*	8H-05AMMM-SL7XXX*			

∟ **Guided M8 (G8) (Metal Nut) > Overmolded with cable > Female Connector > Right Angle**







					
Type	3A/60V	3A/60V	3A/30V	1.5A/30V	
Solder Pin	8A-02AMMM-SR7XXX*	8A-03AMMM-SR7XXX*	8A-04AMMM-SR7XXX*	8A-05AMMM-SR7XXX*	
			* XXX: Choose the cable type and length: - PVC: 1M (A01) / 2M (A02) / 5M (A05) / 10M (A10) - PU: 1M (B01) / 2M (B02) / 5M (B05) / 10M (B10)		
Type	1.5A/30V	3A+1.5A/30V			Hybrid
Solder Pin	8A-06AMMM-SR7XXX*	8H-05AMMM-SR7XXX*			

* Design and specification are subject to change without notice.

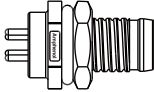



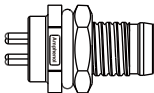

∨ **Guided M8 (G8) (Metal Nut) > Overmolded with cable > Female Connector > Straight**

				 Hybrid
Type	3A/60V	3A/60V	3A/30V	1.5A/30V
Solder Pin	8A-02AFFM-SL7XXX*	8A-03AFFM-SL7XXX*	8A-04AFFM-SL7XXX*	8A-05AFFM-SL7XXX*
		 Hybrid	* XXX: Choose the cable type and length: - PVC: 1M (A01) / 2M (A02) / 5M (A05) / 10M (A10) - PU: 1M (B01) / 2M (B02) / 5M (B05) / 10M (B10)	
Type	1.5A/30V	3A+1.5A/30V		
Solder Pin	8A-05AFFM-SL7XXX*	8H-02AFFM-SL7XXX*		

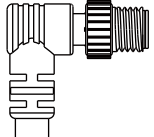
➤ **Guided M8 (G8) (Plastic) > Receptacle > Male Connector > Front Fastened**

				
Backshell: Hexagonal				
Type	3A/60V	3A/60V	3A/30V	1.5A/30V
PCB Pin	8AP-02PMMP-SF7001	8AP-03PMMP-SF7001	8AP-04PMMP-SF7001	8AP-05PMMP-SF7001
Solder Pin	8AP-02PMMS-SF7001	8AP-03PMMS-SF7001	8AP-04PMMS-SF7001	8AP-05PMMS-SF7001
				
Backshell: Hexagonal		Hybrid		
Type	1.5A/30V	3A+1.5A/30V		
PCB Pin	8AP-06PMMP-SF7001	8HP-05PMMP-SF7001		
Solder Pin	8AP-06PMMS-SF7001	8HP-05PMMS-SF7001		

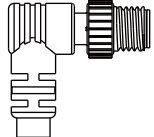
➤ **Guided M8 (G8) (Plastic) > Overmolded with cable > Male Connector > Right Angle**

				
Type	3A/60V	3A/60V	3A/30V	1.5A/30V
Solder Pin	8AP-02AMMM-SR7XXX*	8AP-03AMMM-SR7XXX*	8AP-04AMMM-SR7XXX*	8AP-05AMMM-SR7XXX*
				
Type	1.5A/30V	3A+1.5A/30V		
Solder Pin	8AP-06AMMM-SR7XXX*	8HP-05AMMM-SR7XXX*		

* XXX: Choose the cable type and length:
 - PVC: 1M (A01) / 2M (A02) / 5M (A05) / 10M (A10)
 - PU: 1M (B01) / 2M (B02) / 5M (B05) / 10M (B10)

* Design and specification are subject to change without notice.







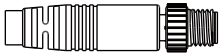

M8 (G8) (Plastic)

Receptacle / Overmolded > Male / Female Connector







IP 67 . 68 9

Receptacle | Unmated
Overmolded with Cable | Mated
Field Installable | Mated

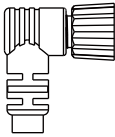
▾ **Guided M8 (G8) (Plastic) > Overmolded with cable > Male Connector > Straight**

				
Type	3A/60V	3A/60V	3A/30V	1.5A/30V
Solder Pin	8AP-02AMMM-SL7XXX*	8AP-03AMMM-SL7XXX*	8AP-04AMMM-SL7XXX*	8AP-05AMMM-SL7XXX*
			* XXX: Choose the cable type and length: - PVC: 1M (A01) / 2M (A02) / 5M (A05) / 10M (A10) - PU: 1M (B01) / 2M (B02) / 5M (B05) / 10M (B10)	
Type	1.5A/30V	3A+1.5A/30V		
Solder Pin	8AP-06AMMM-SL7XXX*	8HP-05AMMM-SL7XXX*		

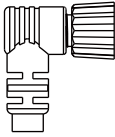
▾ **Guided M8 (G8) (Plastic) > Overmolded with cable > Female Connector > Right Angle**

				
Type	3A/60V	3A/60V	3A/30V	1.5A/30V
Solder Pin	8AP-02AMMM-SR7XXX*	8AP-03AMMM-SR7XXX*	8AP-04AMMM-SR7XXX*	8AP-05AMMM-SR7XXX*
			* XXX: Choose the cable type and length: - PVC: 1M (A01) / 2M (A02) / 5M (A05) / 10M (A10) - PU: 1M (B01) / 2M (B02) / 5M (B05) / 10M (B10)	
Type	1.5A/30V	3A+1.5A/30V		
Solder Pin	8AP-06AMMM-SR7XXX*	8HP-05AMMM-SR7XXX*		

↳ Guided M8 (G8) (Plastic) > Overmolded with cable > Female Connector > Straight

Type	3A/60V	3A/60V	3A/30V	1.5A/30V
Solder Pin	8AP-02AFFM-SL7XXX*	8AP-03AFFM-SL7XXX*	8AP-04AFFM-SL7XXX*	8AP-05AFFM-SL7XXX*
			* XXX: Choose the cable type and length: - PVC: 1M (A01) / 2M (A02) / 5M (A05) / 10M (A10) - PU: 1M (B01) / 2M (B02) / 5M (B05) / 10M (B10)	
Type	1.5A/30V	3A+1.5A/30V		
Solder Pin	8AP-05AFFM-SL7XXX*	8HP-02AFFM-SL7XXX*		

↳ Guided M8 (G8) (Plastic) > Overmolded with cable > Female Connector > Straight > Snap-In

Type	3A/60V	3A/60V	3A/30V	1.5A/30V
Solder Pin	8P-02AFFM-SL7XXX*	8P-03AFFM-SL7XXX*	8P-04AFFM-SL7XXX*	8P-05AFFM-SL7XXX*
			* XXX: Choose the cable type and length: - PVC: 1M (A01) / 2M (A02) / 5M (A05) / 10M (A10) - PU: 1M (B01) / 2M (B02) / 5M (B05) / 10M (B10)	
Type	1.5A/30V	3A+1.5A/30V		
Solder Pin	8P-05AFFM-SL7XXX*	8HP-02AFFM-SL7XXX*		

* Design and specification are subject to change without notice.



M10.5 (Metal)

Receptacle / Overmolded with Cable > Male Connector



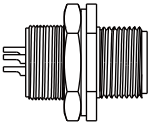
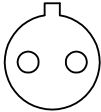
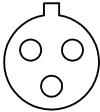
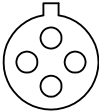

IP 67 . 68 9

Receptacle | Unmated
Overmolded with Cable | Mated
Field Installable | Mated

▾ **M10.5 (Metal) > Receptacle > Male Connector > Rear Fastened**

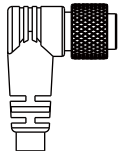

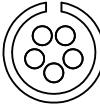

				
Backshell: Hexagonal Backshell: Circular				
Type	2 Contacts	3 Contacts	4 Contacts	5 Contacts
Backshell: Hexagonal Solder Pin (180°)	105-02PMFS-SH7001	105-03PMFS-SH7001	105-04PMFS-SH7001	105-05PMFS-SH7001
Backshell: Circular Solder Pin (180°)	105-02PMFS-SC7001	105-03PMFS-SC7001	105-04PMFS-SC7001	105-05PMFS-SC7001

▾ **M10.5 (Metal) > Overmolded with cable > Male Connector > Right Angle**

				
Type	2 Contacts	3 Contacts	4 Contacts	5 Contacts
With Strain Relief	105-02AFMM-SR7A ^{XXX} *	105-03AFMM-SR7A ^{XXX} *	105-04AFMM-SR7A ^{XXX} *	105-05AFMM-SR7A ^{XXX} *
Without Strain Relief	105-02BFMM-SR7A ^{XXX} *	105-03BFMM-SR7A ^{XXX} *	105-04BFMM-SR7A ^{XXX} *	105-05BFMM-SR7A ^{XXX} *

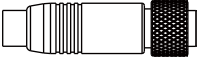
* ^{XXX}: Choose the cable type and length:
 - PVC: 1M (A01) / 2M (A02) / 5M (A05) / 10M (A10)
 - PU: 1M (B01) / 2M (B02) / 5M (B05) / 10M (B10)

▾ **M10.5 (Metal) > Overmolded with cable > Male Connector > Straight**

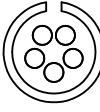
				
Type	2 Contacts	3 Contacts	4 Contacts	5 Contacts
With Strain Relief	105-02AFMM-SL7A ^{XXX} *	105-03AFMM-SL7A ^{XXX} *	105-04AFMM-SL7A ^{XXX} *	105-05AFMM-SL7A ^{XXX} *
Without Strain Relief	105-02BFMM-SL7A ^{XXX} *	105-03BFMM-SL7A ^{XXX} *	105-04BFMM-SL7A ^{XXX} *	105-05BFMM-SL7A ^{XXX} *

* ^{XXX}: Choose the cable type and length:
 - PVC: 1M (A01) / 2M (A02) / 5M (A05) / 10M (A10)
 - PU: 1M (B01) / 2M (B02) / 5M (B05) / 10M (B10)

∨ M12 A-coding (Shielded) > Receptacle > Male Connector > Front Fastened

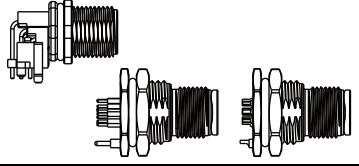
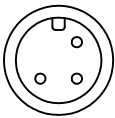
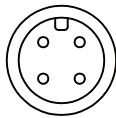
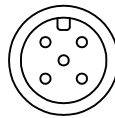
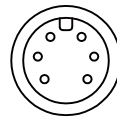
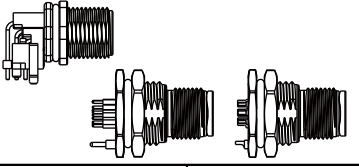
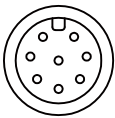
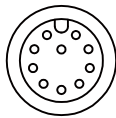
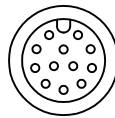
					
Type	Mounting Thread	4A/250V	4A/250V	4A/60V	2A / 30V
PCB Pin (180°)	PG9	MSAS-03PMMP-SF8001	MSAS-04PMMP-SF8001	MSAS-05PMMP-SF8001	MSAS-06PMMP-SF8001
	M16.0	MSAS-03PMMP-SF8002	MSAS-04PMMP-SF8002	MSAS-05PMMP-SF8002	MSAS-06PMMP-SF8002
PCB Pin (90°)	M12	MSAS-03PMMR-SF7003	MSAS-04PMMR-SF7003	MSAS-05PMMR-SF7003	-
Solder Pin (180°)	PG9	MSAS-03PMMS-SF8001	MSAS-04PMMS-SF8001	MSAS-05PMMS-SF8001	MSAS-06PMMS-SF8001
	M16.0	MSAS-03PMMS-SF8002	MSAS-04PMMS-SF8002	MSAS-05PMMS-SF8002	MSAS-06PMMS-SF8002
					
Type	Mounting Thread	2A / 30V	1.5A / 30V	1.5A / 30V	
PCB Pin (180°)	PG9	MSAS-08PMMP-SF8001	MSAS-10PMMP-SF8001	MSAS-12PMMP-SF8001	
	M16.0	MSAS-08PMMP-SF8002	MSAS-10PMMP-SF8002	MSAS-12PMMP-SF8002	
PCB Pin (90°)	M12	MSAS-08PMMR-SF7003	-	-	
Solder Pin (180°)	PG9	MSAS-08PMMS-SF8001	MSAS-10PMMS-SF8001	MSAS-12PMMS-SF8001	
	M16.0	MSAS-08PMMS-SF8002	MSAS-10PMMS-SF8002	MSAS-12PMMS-SF8002	

∨ M12 A-coding (Shielded) > Receptacle > Female Connector > Front Fastened

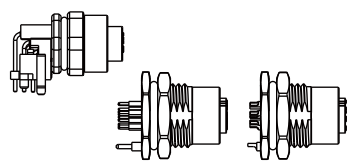
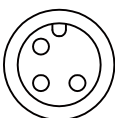
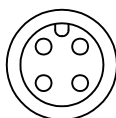
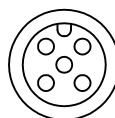
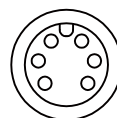
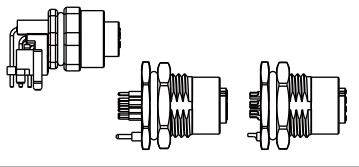
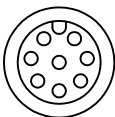
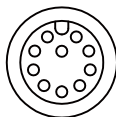
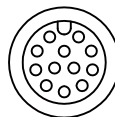
					
Type	Mounting Thread	4A/250V	4A/250V	4A/60V	2A / 30V
PCB Pin (180°)	PG9	MSAS-03PFFP-SF8001	MSAS-04PFFP-SF8001	MSAS-05PFFP-SF8001	MSAS-06PFFP-SF8001
	M16.0	MSAS-03PFFP-SF8002	MSAS-04PFFP-SF8002	MSAS-05PFFP-SF8002	MSAS-06PFFP-SF8002
PCB Pin (90°)	M12	MSAS-03PFFR-SF7003	MSAS-04PFFR-SF7003	MSAS-05PFFR-SF7003	-
Solder Pin (180°)	PG9	MSAS-03PFFS-SF8001	MSAS-04PFFS-SF8001	MSAS-05PFFS-SF8001	MSAS-06PFFS-SF8001
	M16.0	MSAS-03PFFS-SF8002	MSAS-04PFFS-SF8002	MSAS-05PFFS-SF8002	MSAS-06PFFS-SF8002
					
Type	Mounting Thread	2A / 30V	1.5A / 30V	1.5A / 30V	
PCB Pin (180°)	PG9	MSAS-08PFFP-SF8001	MSAS-10PFFP-SF8001	MSAS-12PFFP-SF8001	
	M16.0	MSAS-08PFFP-SF8002	MSAS-10PFFP-SF8002	MSAS-12PFFP-SF8002	
PCB Pin (90°)	M12	MSAS-08PFFR-SF7003	-	-	
Solder Pin (180°)	PG9	MSAS-08PFFS-SF8001	MSAS-10PFFS-SF8001	MSAS-12PFFS-SF8001	
	M16.0	MSAS-08PFFS-SF8002	MSAS-10PFFS-SF8002	MSAS-12PFFS-SF8002	

* Design and specification are subject to change without notice.

∟ M12 A-coding (Shielded) > Receptacle with Wire Harness > Male Connector
> Front Fastened

Backshell: Hexagonal					
Wire Length (UL1061)*	Mounting Thread	4A/250V	4A/250V	4A/60V	2A / 30V
150mm	PG9	MSAS-03PMMC-SF8B15	MSAS-04PMMC-SF8B15	MSAS-05PMMC-SF8B15	MSAS-06PMM5-SF8B15
	M16.0	MSAS-03PMMC-SF8C15	MSAS-04PMMC-SF8C15	MSAS-05PMMC-SF8C15	MSAS-06PMM5-SF8C15
300mm	PG9	MSAS-03PMMC-SF8B30	MSAS-04PMMC-SF8B30	MSAS-05PMMC-SF8B30	MSAS-06PMM5-SF8B30
	M16.0	MSAS-03PMMC-SF8C30	MSAS-04PMMC-SF8C30	MSAS-05PMMC-SF8C30	MSAS-06PMM5-SF8C30
500mm	PG9	MSAS-03PMMC-SF8B50	MSAS-04PMMC-SF8B50	MSAS-05PMMC-SF8B50	MSAS-06PMM5-SF8B50
	M16.0	MSAS-03PMMC-SF8C50	MSAS-04PMMC-SF8C50	MSAS-05PMMC-SF8C50	MSAS-06PMM5-SF8C50
1000mm	PG9	MSAS-03PMMC-SF8BA0	MSAS-04PMMC-SF8BA0	MSAS-05PMMC-SF8BA0	MSAS-06PMM5-SF8BA0
	M16.0	MSAS-03PMMC-SF8CA0	MSAS-04PMMC-SF8CA0	MSAS-05PMMC-SF8CA0	MSAS-06PMM5-SF8CA0
1500mm	PG9	MSAS-03PMMC-SF8BA5	MSAS-04PMMC-SF8BA5	MSAS-05PMMC-SF8BA5	MSAS-06PMM5-SF8BA5
	M16.0	MSAS-03PMMC-SF8CA5	MSAS-04PMMC-SF8CA5	MSAS-05PMMC-SF8CA5	MSAS-06PMM5-SF8CA5
Backshell: Hexagonal					
Wire Length (UL1061)*	Mounting Thread	2A / 30V	1.5A / 30V	1.5A / 30V	
150mm	PG9	MSAS-03PMM5-SF8B15	MSAS-03PMM5-SF8B15	MSAS-03PMM5-SF8B15	
	M16.0	MSAS-03PMM5-SF8C15	MSAS-03PMM5-SF8C15	MSAS-03PMM5-SF8C15	
300mm	PG9	MSAS-03PMM5-SF8B30	MSAS-03PMM5-SF8B30	MSAS-03PMM5-SF8B30	
	M16.0	MSAS-03PMM5-SF8C30	MSAS-03PMM5-SF8C30	MSAS-03PMM5-SF8C30	
500mm	PG9	MSAS-03PMM5-SF8B50	MSAS-03PMM5-SF8B50	MSAS-03PMM5-SF8B50	
	M16.0	MSAS-03PMM5-SF8C50	MSAS-03PMM5-SF8C50	MSAS-03PMM5-SF8C50	
1000mm	PG9	MSAS-03PMM5-SF8BA0	MSAS-03PMM5-SF8BA0	MSAS-03PMM5-SF8BA0	
	M16.0	MSAS-03PMM5-SF8CA0	MSAS-03PMM5-SF8CA0	MSAS-03PMM5-SF8CA0	
1500mm	PG9	MSAS-03PMM5-SF8BA5	MSAS-03PMM5-SF8BA5	MSAS-03PMM5-SF8BA5	
	M16.0	MSAS-03PMM5-SF8CA5	MSAS-03PMM5-SF8CA5	MSAS-03PMM5-SF8CA5	

∟ **M12 A-coding (Shielded) > Receptacle with Wire Harness > Female Connector > Front Fastened**

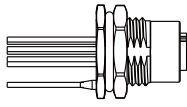
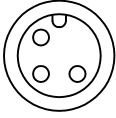
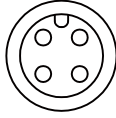
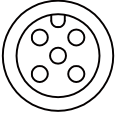
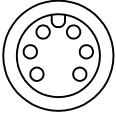
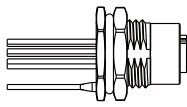
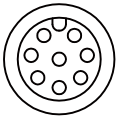
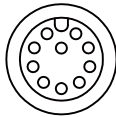
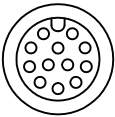
					
Backshell: Hexagonal					
Wire Length (UL1061)*	Mounting Thread	4A/250V	4A/250V	4A/250V	2A / 30V
150mm	PG9	MSAS-03PFFC-SF8B15	MSAS-04PFFC-SF8B15	MSAS-05PFFC-SF8B15	MSAS-06PFF5-SF8B15
	M16.0	MSAS-03PFFC-SF8C15	MSAS-04PFFC-SF8C15	MSAS-05PFFC-SF8C15	MSAS-06PFF5-SF8C15
300mm	PG9	MSAS-03PFFC-SF8B30	MSAS-04PFFC-SF8B30	MSAS-05PFFC-SF8B30	MSAS-06PFF5-SF8B30
	M16.0	MSAS-03PFFC-SF8C30	MSAS-04PFFC-SF8C30	MSAS-05PFFC-SF8C30	MSAS-06PFF5-SF8C30
500mm	PG9	MSAS-03PFFC-SF8B50	MSAS-04PFFC-SF8B50	MSAS-05PFFC-SF8B50	MSAS-06PFF5-SF8B50
	M16.0	MSAS-03PFFC-SF8C50	MSAS-04PFFC-SF8C50	MSAS-05PFFC-SF8C50	MSAS-06PFF5-SF8C50
1000mm	PG9	MSAS-03PFFC-SF8BA0	MSAS-04PFFC-SF8BA0	MSAS-05PFFC-SF8BA0	MSAS-06PFF5-SF8BA0
	M16.0	MSAS-03PFFC-SF8CA0	MSAS-04PFFC-SF8CA0	MSAS-05PFFC-SF8CA0	MSAS-06PFF5-SF8CA0
1500mm	PG9	MSAS-03PFFC-SF8BA5	MSAS-04PFFC-SF8BA5	MSAS-05PFFC-SF8BA5	MSAS-06PFF5-SF8BA5
	M16.0	MSAS-03PFFC-SF8CA5	MSAS-04PFFC-SF8CA5	MSAS-05PFFC-SF8CA5	MSAS-06PFF5-SF8CA5
					
Backshell: Hexagonal					
Wire Length (UL1061)*	Mounting Thread	2A / 30V	1.5A / 30V	1.5A / 30V	
150mm	PG9	MSAS-03PFF5-SF8B15	MSAS-03PFF5-SF8B15	MSAS-03PFF5-SF8B15	
	M16.0	MSAS-03PFF5-SF8C15	MSAS-03PFF5-SF8C15	MSAS-03PFF5-SF8C15	
300mm	PG9	MSAS-03PFF5-SF8B30	MSAS-03PFF5-SF8B30	MSAS-03PFF5-SF8B30	
	M16.0	MSAS-03PFF5-SF8C30	MSAS-03PFF5-SF8C30	MSAS-03PFF5-SF8C30	
500mm	PG9	MSAS-03PFF5-SF8B50	MSAS-03PFF5-SF8B50	MSAS-03PFF5-SF8B50	
	M16.0	MSAS-03PFF5-SF8C50	MSAS-03PFF5-SF8C50	MSAS-03PFF5-SF8C50	
1000mm	PG9	MSAS-03PFF5-SF8BA0	MSAS-03PFF5-SF8BA0	MSAS-03PFF5-SF8BA0	
	M16.0	MSAS-03PFF5-SF8CA0	MSAS-03PFF5-SF8CA0	MSAS-03PFF5-SF8CA0	
1500mm	PG9	MSAS-03PFF5-SF8BA5	MSAS-03PFF5-SF8BA5	MSAS-03PFF5-SF8BA5	
	M16.0	MSAS-03PFF5-SF8CA5	MSAS-03PFF5-SF8CA5	MSAS-03PFF5-SF8CA5	

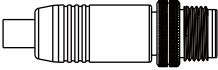
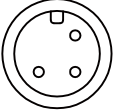
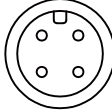
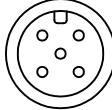
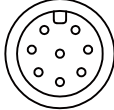

* Design and specification are subject to change without notice.

➤ M12 A-coding (Shielded) > Overmolded with cable > Male Connector > Straight

				
Type	4A/250V	4A/250V	4A/60V	2A / 30V
Without Strain Relief	MSAS-03BMMM-SL7XXX*	MSAS-04BMMM-SL7XXX*	MSAS-05BMMM-SL7XXX*	MSAS-08BMMM-SL7XXX*

* XXX: Choose the cable type and length:
 - PVC: 1M (A01) / 2M (A02) / 5M (A05) / 10M (A10)
 - PU: 1M (B01) / 2M (B02) / 5M (B05) / 10M (B10)

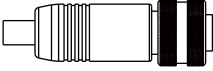
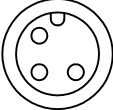
➤ M12 A-coding (Shielded) > Overmolded with cable > Female Connector > Straight

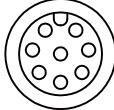
				
Type	4A/250V	4A/250V	4A/60V	2A / 30V
Without Strain Relief	MSAS-03BFFM-SL7XXX*	MSAS-04BBFFM-SL7XXX*	MSAS-05BFFM-SL7XXX*	MSAS-08BFFM-SL7XXX*

* XXX: Choose the cable type and length:
 - PVC: 1M (A01) / 2M (A02) / 5M (A05) / 10M (A10)
 - PU: 1M (B01) / 2M (B02) / 5M (B05) / 10M (B10)



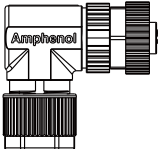
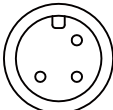
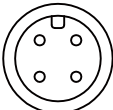
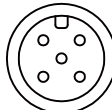
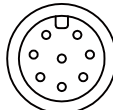
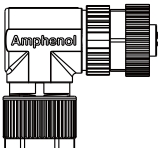
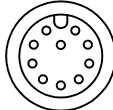
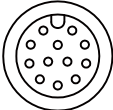

➤ M12 A-coding (Shielded) > Field Installable > Male Connector > Right Angle

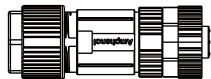
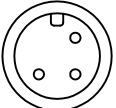
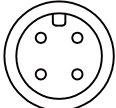
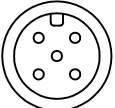
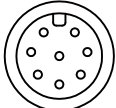
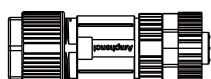
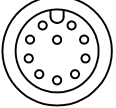
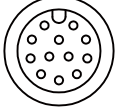
					
Type	Contact Type	4A/250V	4A/250V	4A/60V	2A / 30V
Without Strain Relief	Solder Type	MSAS-03BMMB-SL7001	MSAS-04BMMB-SL7001	MSAS-05BMMB-SL7001	-
	Screw Type	-	-	-	MSAS-08BMMA-SL7001
	IDC Type	-	-	MSAS-05BMMD-SL7001	-
					
Type	Contact Type	1.5A / 30V	1.5A / 30V		
Without Strain Relief	Solder Type	-	-		
	Screw Type	MSAS-10BMMA-SL7001	MSAS-12BMMA-SL7001		
	IDC Type	-	-		

∟ **M12 A-coding (Shielded) > Field Installable > Male Connector > Straight**

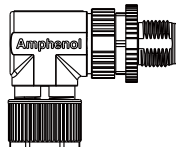
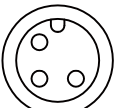
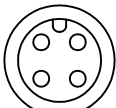
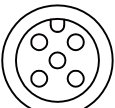
					
Type	Contact Type	4A/250V	4A/250V	4A/60V	2A / 30V
Without Strain Relief	Solder Type	MSAS-03BMMB-SL7001	MSAS-04BMMB-SL7001	MSAS-05BMMB-SL7001	-
	Screw Type	-	-	-	MSAS-08BMMMA-SL7001
	IDC Type	-	-	MSAS-05BMMD-SL7001	-
					
Type	Contact Type	1.5A / 30V	1.5A / 30V		
Without Strain Relief	Solder Type	-	-		
	Screw Type	MSAS-10BMMMA-SL7001	MSAS-12BMMMA-SL7001		
	IDC Type	-	-		

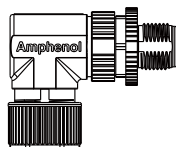
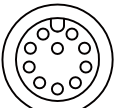
∟ **M12 A-coding (Shielded) > Field Installable > Female Connector > Right Angle**

					
Type	Contact Type	4A/250V	4A/250V	4A/60V	2A / 30V
Without Strain Relief	Solder Type	MSAS-03BMMB-SR7001	MSAS-04BMMB-SR7001	MSAS-05BMMB-SR7001	-
	Screw Type	-	-	-	MSAS-08BMMMA-SR7001
					
Type	Contact Type	1.5A / 30V	1.5A / 30V		
Without Strain Relief	Solder Type	-	-		
	Screw Type	MSAS-10BMMMA-SR7001	MSAS-12BMMMA-SR7001		

* Design and specification are subject to change without notice.



M12 A-coding (Shield)

Field Installable > Female Connector

IP 67 . 68 9

Receptacle | Unmated
Overmolded with Cable | Mated
Field Installable | Mated

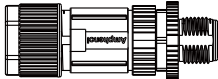
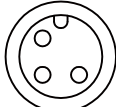
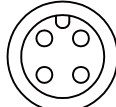
≧ **M12 A-coding (Shielded) > Field Installable > Female Connector > Straight**

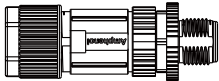
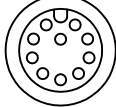
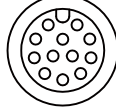
					
Type	Contact Type	4A/250V	4A/250V	4A/60V	2A / 30V
Without Strain Relief	Solder Type	MSAS-03BFFB-SR7001	MSAS-04BFFB-SR7001	MSAS-05BFFB-SR7001	-
	Screw Type	-	-	-	MSAS-08BFFA-SR7001
					
Type	Contact Type	1.5A / 30V	1.5A / 30V		
Without Strain Relief	Solder Type	-	-		
	Screw Type	MSAS-10BFFA-SR7001	MSAS-12BFFA-SR7001		

∟ M12 A-coding (Metal Nut) > Receptacle > Male Connector > Front Fastened

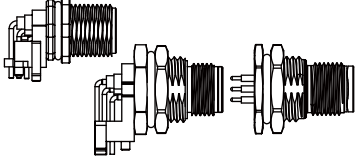
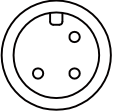
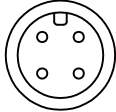
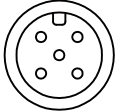
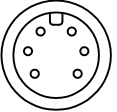
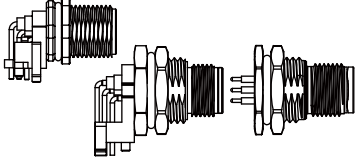
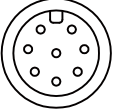
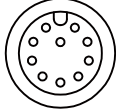
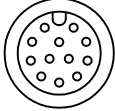

					
Backshell: Hexagonal					
Type	Mounting Thread	4A/250V	4A/250V	4A/60V	2A / 30V
Solder Pin (180°)	PG9	M12A-03PMMP-SF8001	M12A-04PMMP-SF8001	M12A-05PMMP-SF8001	M12A-06PMMP-SF8001
	M16.0	M12A-03PMMP-SF8002	M12A-04PMMP-SF8002	M12A-05PMMP-SF8002	M12A-06PMMP-SF8002
PCB Pin (90°)	M12	M12A-03PMMR-SF7003	M12A-04PMMR-SF7003	M12A-05PMMR-SF7003	-
	PG9	M12A-03PMMR-SF8001	M12A-04PMMR-SF8001	M12A-05PMMR-SF8001	-
	M16.0	M12A-03PMMR-SF8002	M12A-04PMMR-SF8002	M12A-05PMMR-SF8002	-
Solder Pin (180°)	PG9	M12A-03PMMS-SF8001	M12A-04PMMS-SF8001	M12A-05PMMS-SF8001	M12A-06PMMS-SF8001
	M16.0	M12A-03PMMS-SF8002	M12A-04PMMS-SF8002	M12A-05PMMS-SF8002	M12A-06PMMS-SF8002
					
Backshell: Hexagonal					
Type	Mounting Thread	2A / 30V	1.5A / 30V	1.5A / 30V	
PCB Pin (180°)	PG9	M12A-08PMMP-SF8001	M12A-10PMMP-SF8001	M12A-12PMMP-SF8001	
	M16.0	M12A-08PMMP-SF8002	M12A-10PMMP-SF8002	M12A-12PMMP-SF8002	
PCB Pin (90°)	M12	M12A-08PMMR-SF7003	-	-	
	PG9	-	-	-	
Solder Pin (90°)	PG9	M12A-08PMMS-SF8001	M12A-10PMMS-SF8001	M12A-12PMMS-SF8001	
	M16.0	M12A-08PMMS-SF8002	M12A-10PMMS-SF8002	M12A-12PMMS-SF8002	

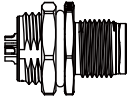
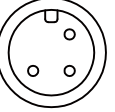
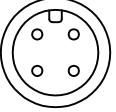
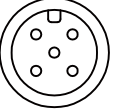
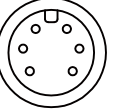
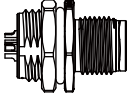
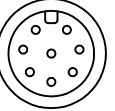
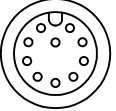
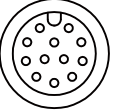
∟ M12 A-coding (Metal Nut) > Receptacle > Male Connector > Front Fastened

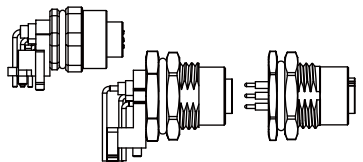
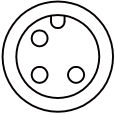
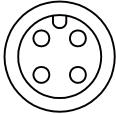
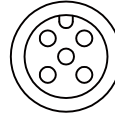
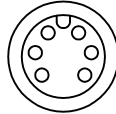
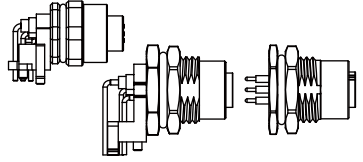

					
Backshell: Hexagonal					
Type	Mounting Thread	4A/250V	4A/250V	4A/60V	2A / 30V
Solder Pin (180°)	PG9	M12A-03PMMS-SH8001	M12A-04PMMS-SH8001	M12A-05PMMS-SH8001	M12A-06PMMS-SH8001
	M16.0	M12A-03PMMS-SH8002	M12A-04PMMS-SH8002	M12A-05PMMS-SH8002	M12A-06PMMS-SH8002
					
Backshell: Hexagonal					
Type	Mounting Thread	2A / 30V	1.5A / 30V	1.5A / 30V	
Solder Pin (180°)	PG9	M12A-08PMMS-SH8001	M12A-10PMMS-SH8001	M12A-12PMMS-SH8001	
	M16.0	M12A-08PMMS-SH8002	M12A-10PMMS-SH8002	M12A-12PMMS-SH8002	

* Design and specification are subject to change without notice.

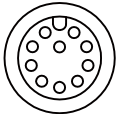
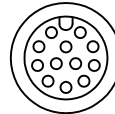
∟ M12 A-coding (Metal Nut) > Receptacle > Female Connector > Front Fastened

					
Backshell: Hexagonal					
Type	Mounting Thread	4A/250V	4A/250V	4A/60V	2A / 30V
PCB Pin (180°)	PG9	M12A-03PFFP-SF8001	M12A-04PFFP-SF8001	M12A-05PFFP-SF8001	M12A-06PFFP-SF8001
	M16.0	M12A-03PFFP-SF8002	M12A-04PFFP-SF8002	M12A-05PFFP-SF8002	M12A-06PFFP-SF8002
PCB Pin (90°)	M12	M12A-03PFFR-SF7003	M12A-04PFFR-SF7003	M12A-05PFFR-SF7003	-
	PG9	M12A-03PFFR-SF8001	M12A-04PFFR-SF8001	M12A-05PFFR-SF8001	-
Solder Pin (180°)	PG9	M12A-03PFFS-SF8001	M12A-04PFFS-SF8001	M12A-05PFFS-SF8001	M12A-06PFFS-SF8001
	M16.0	M12A-03PFFS-SF8002	M12A-04PFFS-SF8002	M12A-05PFFS-SF8002	M12A-06PFFS-SF8002
					
Backshell: Hexagonal					
Type	Mounting Thread	2A / 30V	1.5A / 30V	1.5A / 30V	
PCB Pin (180°)	PG9	M12A-08PFFP-SF8001	M12A-10PFFP-SF8001	M12A-12PFFP-SF8001	
	M16.0	M12A-08PFFP-SF8002	M12A-10PFFP-SF8002	M12A-12PFFP-SF8002	
PCB Pin (90°)	M12	M12A-08PFFR-SF7003	-	-	
	PG9	-	-	-	
Solder Pin (180°)	PG9	M12A-08PFFS-SF8001	M12A-10PFFS-SF8001	M12A-12PFFS-SF8001	
	M16.0	M12A-08PFFS-SF8002	M12A-10PFFS-SF8002	M12A-12PFFS-SF8002	

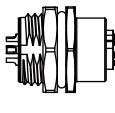
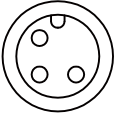
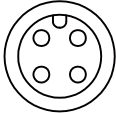
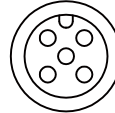
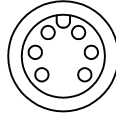
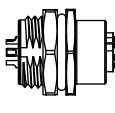
∟ M12 A-coding (Metal Nut) > Receptacle > Female Connector > Front Fastened

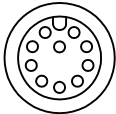
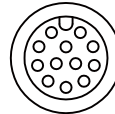
					
Backshell: Hexagonal					
Type	Mounting Thread	4A/250V	4A/250V	4A/60V	2A / 30V
Solder Pin (180)	PG9	M12A-03PFFS-SH8001	M12A-04PFFS-SH8001	M12A-05PFFS-SH8001	M12A-06PFFS-SH8001
	M16.0	M12A-03PFFS-SH8002	M12A-04PFFS-SH8002	M12A-05PFFS-SH8002	M12A-06PFFS-SH8002
					
Backshell: Hexagonal					
Type	Mounting Thread	2A / 30V	1.5A / 30V	1.5A / 30V	
Solder Pin (180)	PG9	M12A-08PFFS-SH8001	M12A-10PFFS-SH8001	M12A-12PFFS-SH8001	
	M16.0	M12A-08PFFS-SH8002	M12A-10PFFS-SH8002	M12A-12PFFS-SH8002	

∟ **M12 A-coding (Metal Nut) > Receptacle with Wire Harness > Male Connector > Front Fastened**

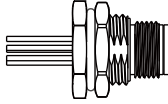
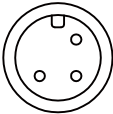
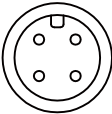
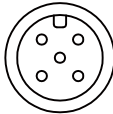
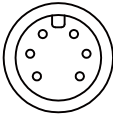
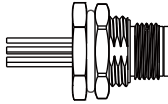
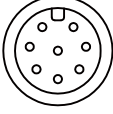
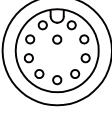
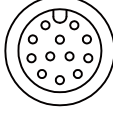
					
Backshell: Hexagonal					
Wire Length (UL1007)*	Mounting Thread	4A/250V	4A/250V	4A/60V	2A / 30V
150mm	PG9	M12A-03PMMC-SF8B15	M12A-04PMMC-SF8B15	M12A-05PMMC-SF8B15	M12A-06PMMS-SF8B15
	M16.0	M12A-03PMMC-SF8C15	M12A-04PMMC-SF8C15	M12A-05PMMC-SF8C15	M12A-06PMMS-SF8C15
300mm	PG9	M12A-03PMMC-SF8B30	M12A-04PMMC-SF8B30	M12A-05PMMC-SF8B30	M12A-06PMMS-SF8B30
	M16.0	M12A-03PMMC-SF8C30	M12A-04PMMC-SF8C30	M12A-05PMMC-SF8C30	M12A-06PMMS-SF8C30
500mm	PG9	M12A-03PMMC-SF8B50	M12A-04PMMC-SF8B50	M12A-05PMMC-SF8B50	M12A-06PMMS-SF8B50
	M16.0	M12A-03PMMC-SF8C50	M12A-04PMMC-SF8C50	M12A-05PMMC-SF8C50	M12A-06PMMS-SF8C50
1000mm	PG9	M12A-03PMMC-SF8BA0	M12A-04PMMC-SF8BA0	M12A-05PMMC-SF8BA0	M12A-06PMMS-SF8BA0
	M16.0	M12A-03PMMC-SF8CA0	M12A-04PMMC-SF8CA0	M12A-05PMMC-SF8CA0	M12A-06PMMS-SF8CA0
1500mm	PG9	M12A-03PMMC-SF8BA5	M12A-04PMMC-SF8BA5	M12A-05PMMC-SF8BA5	M12A-06PMMS-SF8BA5
	M16.0	M12A-03PMMC-SF8CA5	M12A-04PMMC-SF8CA5	M12A-05PMMC-SF8CA5	M12A-06PMMS-SF8CA5
					
Backshell: Hexagonal					
Wire Length (UL1007)*	Mounting Thread	2A / 30V	1.5A / 30V	1.5A / 30V	
150mm	PG9	M12A-08PMMS-SF8B15	M12A-10PMMS-SF8B15	M12A-M12APMMS-SF8B15	
	M16.0	M12A-08PMMS-SF8C15	M12A-10PMMS-SF8C15	M12A-M12APMMS-SF8C15	
300mm	PG9	M12A-08PMMS-SF8B30	M12A-10PMMS-SF8B30	M12A-M12APMMS-SF8B30	
	M16.0	M12A-08PMMS-SF8C30	M12A-10PMMS-SF8C30	M12A-M12APMMS-SF8C30	
500mm	PG9	M12A-08PMMS-SF8B50	M12A-10PMMS-SF8B50	M12A-M12APMMS-SF8B50	
	M16.0	M12A-08PMMS-SF8C50	M12A-10PMMS-SF8C50	M12A-M12APMMS-SF8C50	
1000mm	PG9	M12A-08PMMS-SF8BA0	M12A-10PMMS-SF8BA0	M12A-M12APMMS-SF8BA0	
	M16.0	M12A-08PMMS-SF8CA0	M12A-10PMMS-SF8CA0	M12A-M12APMMS-SF8CA0	
1500mm	PG9	M12A-08PMMS-SF8BA5	M12A-10PMMS-SF8BA5	M12A-M12APMMS-SF8BA5	
	M16.0	M12A-08PMMS-SF8CA5	M12A-10PMMS-SF8CA5	M12A-M12APMMS-SF8CA5	

* Design and specification are subject to change without notice.

➤ **M12 A-coding (Metal Nut) > Receptacle with Wire Harness > Male Connector > Rear Fastened**

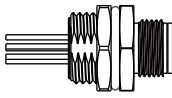
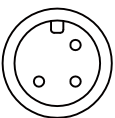
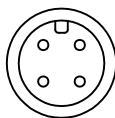
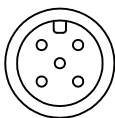
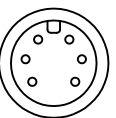
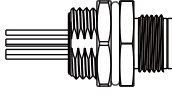
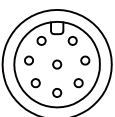
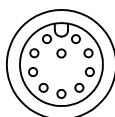
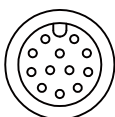
					
Backshell: Hexagonal					
Wire Length (UL1007)*	Mounting Thread	4A/250V	4A/250V	4A/60V	2A / 30V
150mm	PG9	M12A-03PMMC-SH8B15	M12A-04PMMC-SH8B15	M12A-05PMMC-SH8B15	M12A-06PMMMS-SH8B15
	M16.0	M12A-03PMMC-SH8C15	M12A-04PMMC-SH8C15	M12A-05PMMC-SH8C15	M12A-06PMMMS-SH8C15
300mm	PG9	M12A-03PMMC-SH8B30	M12A-04PMMC-SH8B30	M12A-05PMMC-SH8B30	M12A-06PMMMS-SH8B30
	M16.0	M12A-03PMMC-SH8C30	M12A-04PMMC-SH8C30	M12A-05PMMC-SH8C30	M12A-06PMMMS-SH8C30
500mm	PG9	M12A-03PMMC-SH8B50	M12A-04PMMC-SH8B50	M12A-05PMMC-SH8B50	M12A-06PMMMS-SH8B50
	M16.0	M12A-03PMMC-SH8C50	M12A-04PMMC-SH8C50	M12A-05PMMC-SH8C50	M12A-06PMMMS-SH8C50
1000mm	PG9	M12A-03PMMC-SH8BA0	M12A-04PMMC-SH8BA0	M12A-05PMMC-SH8BA0	M12A-06PMMMS-SH8BA0
	M16.0	M12A-03PMMC-SH8CA0	M12A-04PMMC-SH8CA0	M12A-05PMMC-SH8CA0	M12A-06PMMMS-SH8CA0
1500mm	PG9	M12A-03PMMC-SH8BA5	M12A-04PMMC-SH8BA5	M12A-05PMMC-SH8BA5	M12A-06PMMMS-SH8BA5
	M16.0	M12A-03PMMC-SH8CA5	M12A-04PMMC-SH8CA5	M12A-05PMMC-SH8CA5	M12A-06PMMMS-SH8CA5
					
Backshell: Hexagonal					
Wire Length (UL1007)*	Mounting Thread	2A / 30V	1.5A / 30V	1.5A / 30V	
150mm	PG9	M12A-08PMMMS-SH8B15	M12A-10PMMMS-SH8B15	M12A-M12APMMS-SH8B15	
	M16.0	M12A-08PMMMS-SH8C15	M12A-10PMMMS-SH8C15	M12A-M12APMMS-SH8C15	
300mm	PG9	M12A-08PMMMS-SH8B30	M12A-10PMMMS-SH8B30	M12A-M12APMMS-SH8B30	
	M16.0	M12A-08PMMMS-SH8C30	M12A-10PMMMS-SH8C30	M12A-M12APMMS-SH8C30	
500mm	PG9	M12A-08PMMMS-SH8B50	M12A-10PMMMS-SH8B50	M12A-M12APMMS-SH8B50	
	M16.0	M12A-08PMMMS-SH8C50	M12A-10PMMMS-SH8C50	M12A-M12APMMS-SH8C50	
1000mm	PG9	M12A-08PMMMS-SH8BA0	M12A-10PMMMS-SH8BA0	M12A-M12APMMS-SH8BA0	
	M16.0	M12A-08PMMMS-SH8CA0	M12A-10PMMMS-SH8CA0	M12A-M12APMMS-SH8CA0	
1500mm	PG9	M12A-08PMMMS-SH8BA5	M12A-10PMMMS-SH8BA5	M12A-M12APMMS-SH8BA5	
	M16.0	M12A-08PMMMS-SH8CA5	M12A-10PMMMS-SH8CA5	M12A-M12APMMS-SH8CA5	

∟ **M12 A-coding (Metal Nut) > Receptacle with Wire Harness**
> Female Connector > Front Fastened

Backshell: Hexagonal					
Wire Length (UL1007)*	Mounting Thread	4A/250V	4A/250V	4A/60V	2A / 30V
150mm	PG9	M12A-03PFFC-SF8B15	M12A-04PFFC-SF8B15	M12A-05PFFC-SF8B15	M12A-06PFFS-SF8B15
	M16.0	M12A-03PFFC-SF8C15	M12A-04PFFC-SF8C15	M12A-05PFFC-SF8C15	M12A-06PFFS-SF8C15
300mm	PG9	M12A-03PFFC-SF8B30	M12A-04PFFC-SF8B30	M12A-05PFFC-SF8B30	M12A-06PFFS-SF8B30
	M16.0	M12A-03PFFC-SF8C30	M12A-04PFFC-SF8C30	M12A-05PFFC-SF8C30	M12A-06PFFS-SF8C30
500mm	PG9	M12A-03PFFC-SF8B50	M12A-04PFFC-SF8B50	M12A-05PFFC-SF8B50	M12A-06PFFS-SF8B50
	M16.0	M12A-03PFFC-SF8C50	M12A-04PFFC-SF8C50	M12A-05PFFC-SF8C50	M12A-06PFFS-SF8C50
1000mm	PG9	M12A-03PFFC-SF8BA0	M12A-04PFFC-SF8BA0	M12A-05PFFC-SF8BA0	M12A-06PFFS-SF8BA0
	M16.0	M12A-03PFFC-SF8CA0	M12A-04PFFC-SF8CA0	M12A-05PFFC-SF8CA0	M12A-06PFFS-SF8CA0
1500mm	PG9	M12A-03PFFC-SF8BA5	M12A-04PFFC-SF8BA5	M12A-05PFFC-SF8BA5	M12A-06PFFS-SF8BA5
	M16.0	M12A-03PFFC-SF8CA5	M12A-04PFFC-SF8CA5	M12A-05PFFC-SF8CA5	M12A-06PFFS-SF8CA5
Backshell: Hexagonal					
Wire Length (UL1007)*	Mounting Thread	2A / 30V	1.5A / 30V	1.5A / 30V	
150mm	PG9	M12A-08PFFS-SF8B15	M12A-10PFFS-SF8B15	M12A-M12APFFS-SF8B15	
	M16.0	M12A-08PFFS-SF8C15	M12A-10PFFS-SF8C15	M12A-M12APFFS-SF8C15	
300mm	PG9	M12A-08PFFS-SF8B30	M12A-10PFFS-SF8B30	M12A-M12APFFS-SF8B30	
	M16.0	M12A-08PFFS-SF8C30	M12A-10PFFS-SF8C30	M12A-M12APFFS-SF8C30	
500mm	PG9	M12A-08PFFS-SF8B50	M12A-10PFFS-SF8B50	M12A-M12APFFS-SF8B50	
	M16.0	M12A-08PFFS-SF8C50	M12A-10PFFS-SF8C50	M12A-M12APFFS-SF8C50	
1000mm	PG9	M12A-08PFFS-SF8BA0	M12A-10PFFS-SF8BA0	M12A-M12APFFS-SF8BA0	
	M16.0	M12A-08PFFS-SF8CA0	M12A-10PFFS-SF8CA0	M12A-M12APFFS-SF8CA0	
1500mm	PG9	M12A-08PFFS-SF8BA5	M12A-10PFFS-SF8BA5	M12A-M12APFFS-SF8BA5	
	M16.0	M12A-08PFFS-SF8CA5	M12A-10PFFS-SF8CA5	M12A-M12APFFS-SF8CA5	

* Design and specification are subject to change without notice.

M12 A-coding (Metal Nut)

Receptacle with Wire Harness > Female Connector

IP 67 . 68 9

Receptacle | Unmated
Overmolded with Cable | Mated
Field Installable | Mated

**➤ M12 A-coding (Metal Nut) > Receptacle with Wire Harness
> Female Connector > Rear Fastened**

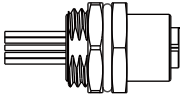
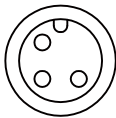
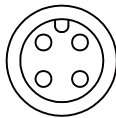
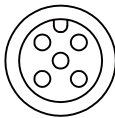
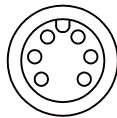
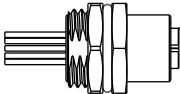
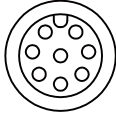
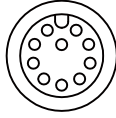
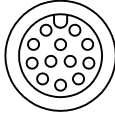
					
Backshell: Hexagonal					
Wire Length (UL1007)*	Mounting Thread	4A/250V	4A/250V	4A/60V	2A / 30V
150mm	PG9	M12A-03PFFC-SH8B15	M12A-04PFFC-SH8B15	M12A-05PFFC-SH8B15	M12A-06PFFS-SH8B15
	M16.0	M12A-03PFFC-SH8C15	M12A-04PFFC-SH8C15	M12A-05PFFC-SH8C15	M12A-06PFFS-SH8C15
300mm	PG9	M12A-03PFFC-SH8B30	M12A-04PFFC-SH8B30	M12A-05PFFC-SH8B30	M12A-06PFFS-SH8B30
	M16.0	M12A-03PFFC-SH8C30	M12A-04PFFC-SH8C30	M12A-05PFFC-SH8C30	M12A-06PFFS-SH8C30
500mm	PG9	M12A-03PFFC-SH8B50	M12A-04PFFC-SH8B50	M12A-05PFFC-SH8B50	M12A-06PFFS-SH8B50
	M16.0	M12A-03PFFC-SH8C50	M12A-04PFFC-SH8C50	M12A-05PFFC-SH8C50	M12A-06PFFS-SH8C50
1000mm	PG9	M12A-03PFFC-SH8BA0	M12A-04PFFC-SH8BA0	M12A-05PFFC-SH8BA0	M12A-06PFFS-SH8BA0
	M16.0	M12A-03PFFC-SH8CA0	M12A-04PFFC-SH8CA0	M12A-05PFFC-SH8CA0	M12A-06PFFS-SH8CA0
1500mm	PG9	M12A-03PFFC-SH8BA5	M12A-04PFFC-SH8BA5	M12A-05PFFC-SH8BA5	M12A-06PFFS-SH8BA5
	M16.0	M12A-03PFFC-SH8CA5	M12A-04PFFC-SH8CA5	M12A-05PFFC-SH8CA5	M12A-06PFFS-SH8CA5
					
Backshell: Hexagonal					
Wire Length (UL1007)*	Mounting Thread	2A / 30V	1.5A / 30V	1.5A / 30V	
150mm	PG9	M12A-08PFFS-SH8B15	M12A-10PFFS-SH8B15	M12A-M12APFFS-SH8B15	
	M16.0	M12A-08PFFS-SH8C15	M12A-10PFFS-SH8C15	M12A-M12APFFS-SH8C15	
300mm	PG9	M12A-08PFFS-SH8B30	M12A-10PFFS-SH8B30	M12A-M12APFFS-SH8B30	
	M16.0	M12A-08PFFS-SH8C30	M12A-10PFFS-SH8C30	M12A-M12APFFS-SH8C30	
500mm	PG9	M12A-08PFFS-SH8B50	M12A-10PFFS-SH8B50	M12A-M12APFFS-SH8B50	
	M16.0	M12A-08PFFS-SH8C50	M12A-10PFFS-SH8C50	M12A-M12APFFS-SH8C50	
1000mm	PG9	M12A-08PFFS-SH8BA0	M12A-10PFFS-SH8BA0	M12A-M12APFFS-SH8BA0	
	M16.0	M12A-08PFFS-SH8CA0	M12A-10PFFS-SH8CA0	M12A-M12APFFS-SH8CA0	
1500mm	PG9	M12A-08PFFS-SH8BA5	M12A-10PFFS-SH8BA5	M12A-M12APFFS-SH8BA5	
	M16.0	M12A-08PFFS-SH8CA5	M12A-10PFFS-SH8CA5	M12A-M12APFFS-SH8CA5	

∟ **M12 D (Plastic) > Overmolded with cable > Female Connector > Right Angle**

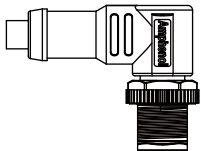
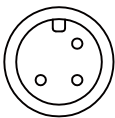
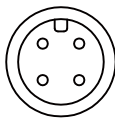
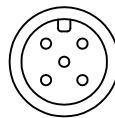
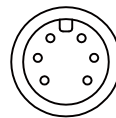
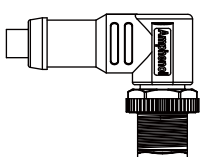
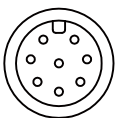
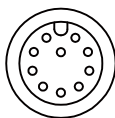
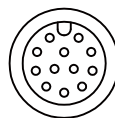
				
Type	4A/250V	4A/250V	4A/60V	2A / 30V
Without Strain Relief	M12A-03BMMM-SR8XXX*	M12A-04BMMM-SR8XXX*	M12A-05BMMM-SR8XXX*	M12A-06BMMM-SR8XXX*
				
Type	4A/250V	4A/250V	4A/60V	
Without Strain Relief	M12A-03BMMM-SR8XXX*	M12A-04BMMM-SR8XXX*	M12A-05BMMM-SR8XXX*	

* XXX: Choose the cable type and length:
 - PVC(UL2517 Yellow): 1M (A01) / 2M (A02) / 5M (A05) / 10M (A10)
 - PU(UL20549 Black): 1M (B01) / 2M (B02) / 5M (B05) / 10M (B10)
 - PVC(UL2517 Black): 1M (D01) / 2M (D02) / 5M (D05) / 10M (D10)

∟ **M12 A-coding (Metal Nut) > Overmolded with Cable > Male Connector > Straight**

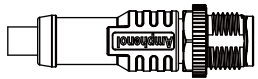
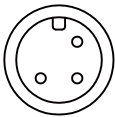
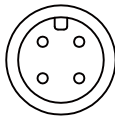
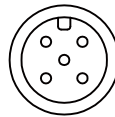
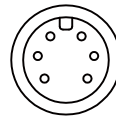
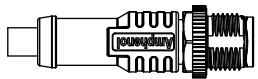
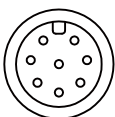
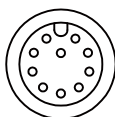
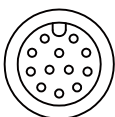
				
Type	4A/250V	4A/250V	4A/60V	2A / 30V
Without Strain Relief	M12A-03BMMM-SL8XXX*	M12A-04BMMM-SL8XXX*	M12A-05BMMM-SL8XXX*	M12A-06BMMM-SL8XXX*
				
Type	4A/250V	4A/250V	4A/60V	
Without Strain Relief	M12A-03BMMM-SL8XXX*	M12A-04BMMM-SL8XXX*	M12A-05BMMM-SL8XXX*	

* XXX: Choose the cable type and length:
 - PVC(UL2517 Yellow): 1M (A01) / 2M (A02) / 5M (A05) / 10M (A10)
 - PU(UL20549 Black): 1M (B01) / 2M (B02) / 5M (B05) / 10M (B10)
 - PVC(UL2517 Black): 1M (D01) / 2M (D02) / 5M (D05) / 10M (D10)

* Design and specification are subject to change without notice.



M12 A-coding (Metal Nut)

Overmolded with Cable > Female Connector

IP 67 . 68 9

Receptacle | Unmated
Overmolded with Cable | Mated
Field Installable | Mated

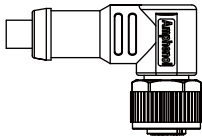
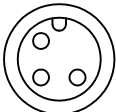
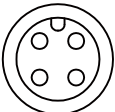
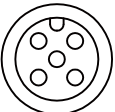

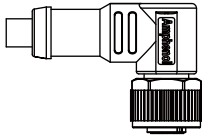
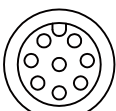
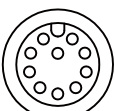
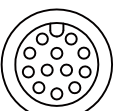
∟ **M12 A-coding (Metal Nut) > Overmolded with Cable > Female Connector > Right Angle**

				
Type	4A/250V	4A/250V	4A/60V	2A / 30V
Without Strain Relief	M12A-03BFFM-SR8XXX*	M12A-04BFFM-SR8XXX*	M12A-05BFFM-SR8XXX*	M12A-06BFFM-SR8XXX*
				
Type	4A/250V	4A/250V	4A/60V	
Without Strain Relief	M12A-03BFFM-SR8XXX*	M12A-04BFFM-SR8XXX*	M12A-05BFFM-SR8XXX*	

* XXX: Choose the cable type and length:

- PVC(UL2517 Yellow): 1M (A01) / 2M (A02) / 5M (A05) / 10M (A10)
- PU(UL20549 Black): 1M (B01) / 2M (B02) / 5M (B05) / 10M (B10)
- PVC(UL2517 Black): 1M (D01) / 2M (D02) / 5M (D05) / 10M (D10)

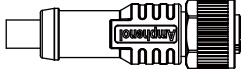
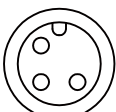
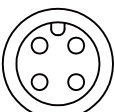
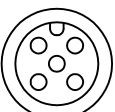
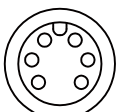
∟ **M12 A-coding (Metal Nut) > Overmolded with Cable > Female Connector > Straight**

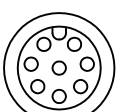
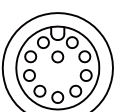
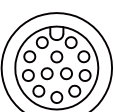
				
Type	4A/250V	4A/250V	4A/60V	2A / 30V
Without Strain Relief	M12A-03BFFM-SL8XXX*	M12A-04BFFM-SL8XXX*	M12A-05BFFM-SL8XXX*	M12A-06BFFM-SL8XXX*
				
Type	4A/250V	4A/250V	4A/60V	
Without Strain Relief	M12A-03BFFM-SL8XXX*	M12A-04BFFM-SL8XXX*	M12A-05BFFM-SL8XXX*	

* XXX: Choose the cable type and length:

- PVC(UL2517 Yellow): 1M (A01) / 2M (A02) / 5M (A05) / 10M (A10)
- PU(UL20549 Black): 1M (B01) / 2M (B02) / 5M (B05) / 10M (B10)
- PVC(UL2517 Black): 1M (D01) / 2M (D02) / 5M (D05) / 10M (D10)

∟ M12 A-coding (Metal Nut) > Field Installable > Male Connector > Right Angle

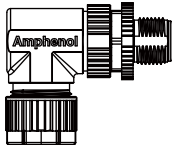
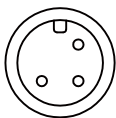
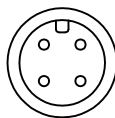
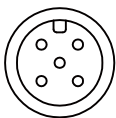
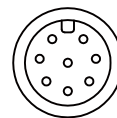
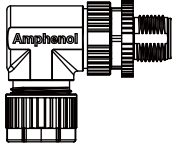
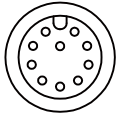
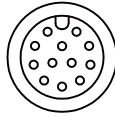
					
Type	Contact Type	4A/250V	4A/250V	4A/60V	2A / 30V
Without Strain Relief	Solder Type	-	-	-	-
	Screw Type	M12A-03BMMB-SR7001	M12A-04BMMB-SR7001	M12A-05BMMB-SR7001	M12A-08BMMB-SR7001
					
Type	Contact Type	1.5A / 30V	1.5A / 30V		
Without Strain Relief	Solder Type	M12A-10BMMA-SR7001	M12A-M12ABMMA-SR7001		
	Screw Type	-	-		

∟ M12 A-coding (Metal Nut) > Field Installable > Male Connector > Straight

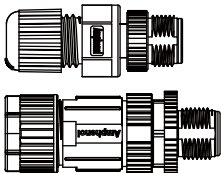
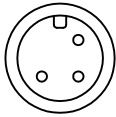
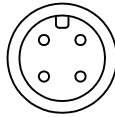
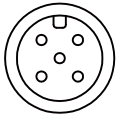
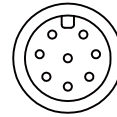
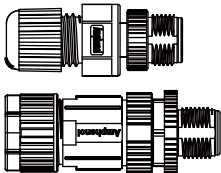
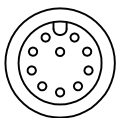
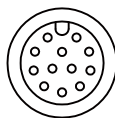
						
Type	Screw Type	Contact Type	4A/250V	4A/250V	4A/60V	2A / 30V
Without Strain Relief		Solder Type	M12A-03BMMA-SL8001	M12A-04BMMA-SL8001	M12A-05BMMA-SL8001	M12A-08BMMA-SL8001
		Screw Type	M12A-03BMMB-SL7001	M12A-04BMMB-SL7001	M12A-05BMMB-SL7001	M12A-08BMMB-SL7001
		IDC Type	-	-	M12A-05BMMD-SL7001	-
						
Type	Screw Type	Contact Type	1.5A / 30V	1.5A / 30V		
Without Strain Relief		Solder Type	M12A-10BMMA-SL7001	M12A-M12ABMMA-SL7001		
		Screw Type	-	-		
		IDC Type	-	-		

* Design and specification are subject to change without notice.

∟ **M12 A-coding (Metal Nut) > Field Installable > Female Connector**
> Right Angle

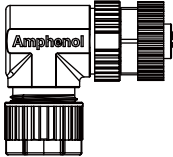
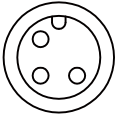
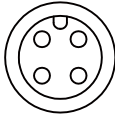
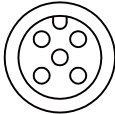
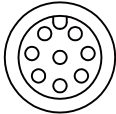
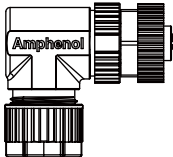
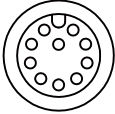
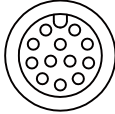
					
Type	Contact Type	4A/250V	4A/250V	4A/60V	2A / 30V
Without Strain Relief	Solder Type	-	-	-	-
	Screw Type	M12A-03BFFB-SR7001	M12A-04BFFB-SR7001	M12A-05BFFB-SR7001	M12A-08BFFB-SR7001
					
Type	Contact Type	1.5A / 30V	1.5A / 30V		
Without Strain Relief	Solder Type	M12A-10BFFA-SR7001	M12A-M12ABFFA-SR7001		
	Screw Type	-	-		

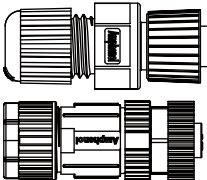
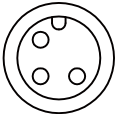
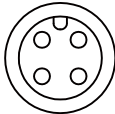
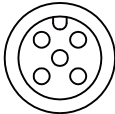
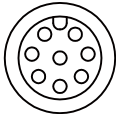
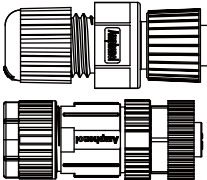
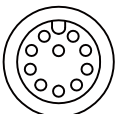
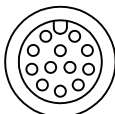

∟ **M12 A-coding (Metal Nut) > Field Installable > Female Connector**
> Right Angle

					
Type	Contact Type	4A/250V	4A/250V	4A/60V	2A / 30V
Without Strain Relief	Solder Type	M12A-03BFFA-SL8001	M12A-04BFFA-SL8001	M12A-05BFFA-SL8001	M12A-08BFFA-SL8001
	Screw Type	M12A-03BFFB-SL7001	M12A-04BFFB-SL7001	M12A-05BFFB-SL7001	M12A-08BFFB-SL7001
	IDC Type	-	-	M12A-05BMMD-SL7001	-
					
Type	Contact Type	1.5A / 30V	1.5A / 30V		
Without Strain Relief	Solder Type	M12A-08BFFA-SL7001	M12A-08BFFA-SL7001		
	Screw Type	-	-		
	IDC Type	-	-		

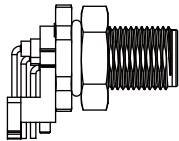
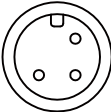
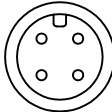
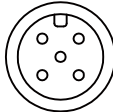
∟ M12 A-coding (Plastic) > Receptacle > Male Connector > Front Fastened

				
Backshell: Hexagonal				
Type	Mounting Thread	4A/250V	4A/250V	4A/60V
Solder Pin (90°)	M12	MSAP-03PMMR-SF8003	MSAP-04PMMR-SF8003	MSAP-05PMMR-SF8003

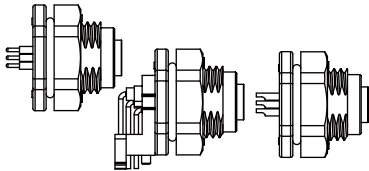
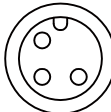
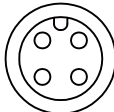
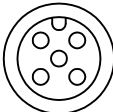
∟ M12 A-coding (Plastic) > Receptacle > Male Connector > Front Fastened

					
Backshell: Hexagonal					
Type	Mounting Thread	4A/250V	4A/250V	4A/60V	2A / 30V
PCB Pin (180°)	M16.0	MSAP-03PFFP-SF8002	MSAP-04PFFP-SF8002	MSAP-05PFFP-SF8002	MSAP-08PFFP-SF8002
PCB Pin (90°)	M16.0	MSAP-03PFFR-SF8002	MSAP-04PFFR-SF8002	MSAP-05PFFR-SF8002	-
Solder Pin (180°)	M16.0	MSAP-03PFFS-SF8002	MSAP-04PFFS-SF8002	MSAP-05PFFS-SF8002	MSAP-08PFFS-SF8002

∟ M12 A-coding (Plastic) > Overmolded with Cable > Male Connector > Right Angle

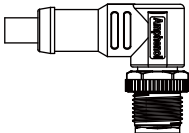
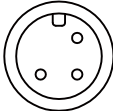
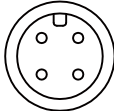
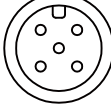
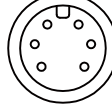
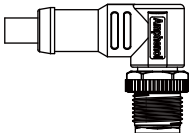
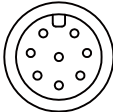
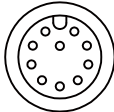
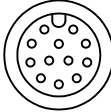

				
Type	4A/250V	4A/250V	4A/60V	2A / 30V
Without Strain Relief	MSAP-03BMMM-SR8XXX*	MSAP-04BMMM-SR8XXX*	MSAP-05BMMM-SR8XXX*	MSAP-06BMMM-SR8XXX*
				
Type	2A / 30V	1.5A / 30V	1.5A / 30V	
Without Strain Relief	MSAP-08BMMM-SR8XXX*	MSAP-10BMMM-SR8XXX*	MSAP-12BMMM-SR8XXX*	

* XXX: Choose the cable type and length:

- PVC (UL2517 Yellow): 1M (A01) / 2M (A02) / 5M (A05) / 10M (A10)
- PU (UL20549 Black): 1M (B01) / 2M (B02) / 5M (B05) / 10M (B10)
- PVC (UL2517 Black): 1M (D01) / 2M (D02) / 5M (D05) / 10M (D10)

* Design and specification are subject to change without notice.

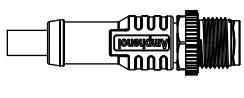
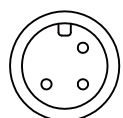
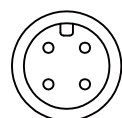
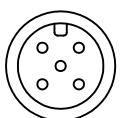
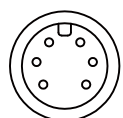
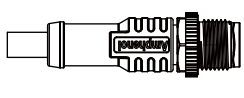
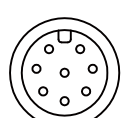
➤ M12 A-coding (Plastic) > Overmolded with Cable > Male Connector > Straight

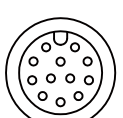
				
Type	4A/250V	4A/250V	4A/60V	2A / 30V
Without Strain Relief	MSAP-03BMMM-SL8XXX*	MSAP-04BMMM-SL8XXX*	MSAP-05BMMM-SL8XXX*	MSAP-06BMMM-SL8XXX*
				
Type	2A / 30V	1.5A / 30V	1.5A / 30V	
Without Strain Relief	MSAP-08BMMM-SL8XXX*	MSAP-10BMMM-SL8XXX*	MSAP-12BMMM-SL8XXX*	

* XXX: Choose the cable type and length:

- PVC (UL2517 Yellow): 1M (A01) / 2M (A02) / 5M (A05) / 10M (A10)
- PU (UL20549 Black): 1M (B01) / 2M (B02) / 5M (B05) / 10M (B10)
- PVC (UL2517 Black): 1M (D01) / 2M (D02) / 5M (D05) / 10M (D10)

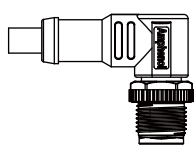
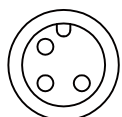
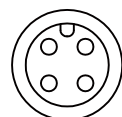
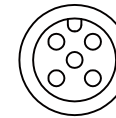
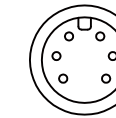
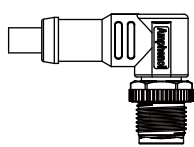
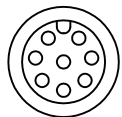
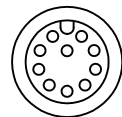
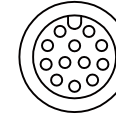

➤ M12 A-coding (Plastic) > Overmolded with Cable > Female Connector > Right Angle

				
Type	4A/250V	4A/250V	4A/60V	2A / 30V
Without Strain Relief	MSAP-03BFFM-SR8XXX*	MSAP-04BFFM-SR8XXX*	MSAP-05BFFM-SR8XXX*	MSAP-06BFFM-SR8XXX*
				
Type	2A / 30V	1.5A / 30V	1.5A / 30V	
Without Strain Relief	MSAP-08BFFM-SR8XXX*	MSAP-10BFFM-SR8XXX*	MSAP-12BFFM-SR8XXX*	

* XXX: Choose the cable type and length:

- PVC (UL2517 Yellow): 1M (A01) / 2M (A02) / 5M (A05) / 10M (A10)
- PU (UL20549 Black): 1M (B01) / 2M (B02) / 5M (B05) / 10M (B10)
- PVC (UL2517 Black): 1M (D01) / 2M (D02) / 5M (D05) / 10M (D10)

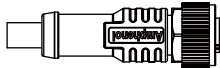
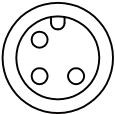
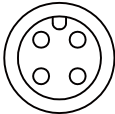
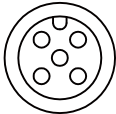
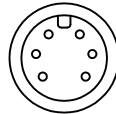
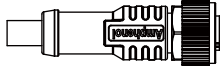

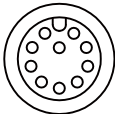
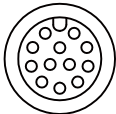
∟ **M12 A-coding (Plastic) > Overmolded with Cable > Female Connector > Straight**

				
Type	4A/250V	4A/250V	4A/60V	2A / 30V
Without Strain Relief	MSAP-03BFFM-SL8XXX*	MSAP-04BFFM-SL8XXX*	MSAP-05BFFM-SL8XXX*	MSAP-06BFFM-SL8XXX*
				
Type	2A / 30V	1.5A / 30V	1.5A / 30V	
Without Strain Relief	MSAP-08BFFM-SL8XXX*	MSAP-10BFFM-SL8XXX*	MSAP-12BFFM-SL8XXX*	

* XXX: Choose the cable type and length:

- PVC (UL2517 Yellow): 1M (A01) / 2M (A02) / 5M (A05) / 10M (A10)
- PU (UL20549 Black): 1M (B01) / 2M (B02) / 5M (B05) / 10M (B10)
- PVC (UL2517 Black): 1M (D01) / 2M (D02) / 5M (D05) / 10M (D10)

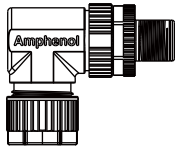
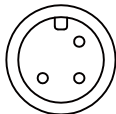
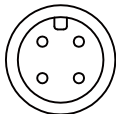
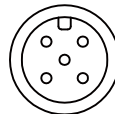
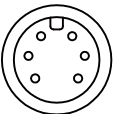
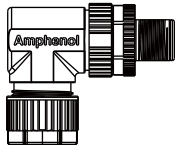
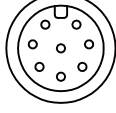
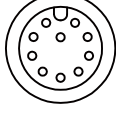
∟ **M12 A-coding (Plastic) > Field Installable > Male Connector > Right Angle**



					
Type	Contact Type	4A/250V	4A/250V	4A/60V	2A / 30V
Without Strain Relief	Solder Type	-	-	-	-
	Screw Type	MSAP-03BMMB-SR7001	MSAP-04BMMB-SR7001	MSAP-05BMMB-SR7001	MSAP-08BMMB-SR7001
	IDC	-	-	-	-
					
Type	Contact Type	2A / 30V	1.5A / 30V	1.5A / 30V	
Without Strain Relief	Solder Type	-	MSAP-10BMMB-SR7001	MSAP-12BMMB-SR7001	
	Screw Type	MSAP-08BMMB-SR7001	-	-	
	IDC	-	-	-	

* Design and specification are subject to change without notice.

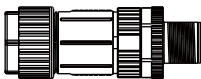
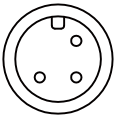
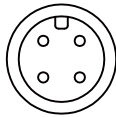
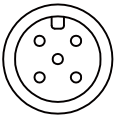
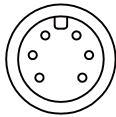
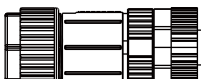
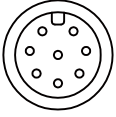
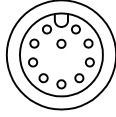
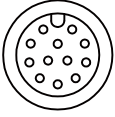

└ M12 A-coding (Plastic) > Field Installable > Male Connector > Straight

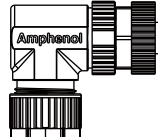
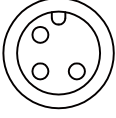
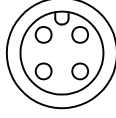
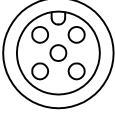
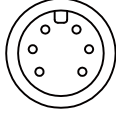
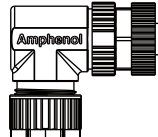
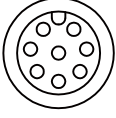
					
					
Type	Contact Type	4A/250V	4A/250V	4A/60V	2A / 30V
Without Strain Relief	Solder Type	MSAP-03BMMA-SL8001	MSAP-04BMMA-SL8001	MSAP-05BMMA-SL8001	MSAP-08BMMA-SL8001
	Screw Type	MSAP-03BMMB-SL7001	MSAP-04BMMB-SL7001	MSAP-05BMMB-SL7001	MSAP-08BMMB-SL7001
	IDC	-	-	MSAP-05BMMD-SL7001	-
Type	Contact Type	2A / 30V	1.5A / 30V	1.5A / 30V	
Without Strain Relief	Solder Type	MSAP-08BMMA-SL8001	MSAP-10BMMA-SL7001	MSAP-12BMMA-SL7001	
	Screw Type	MSAP-08BMMB-SL7001	-	-	
	IDC	-	-	-	

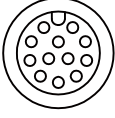
└ M12 A-coding (Plastic) > Field Installable > Female Connector > Right Angle

					
					
Type	Contact Type	4A/250V	4A/250V	4A/60V	2A / 30V
Without Strain Relief	Solder Type	-	-	-	-
	Screw Type	MSAP-03BFFB-SR7001	MSAP-04BFFB-SR7001	MSAP-05BFFB-SR7001	MSAP-08BFFB-SR7001
	IDC	-	-	-	-
Type	Contact Type	2A / 30V	1.5A / 30V	1.5A / 30V	
Without Strain Relief	Solder Type	-	MSAP-10BFFA-SR7001	MSAP-12BFFA-SR7001	
	Screw Type	MSAP-08BFFB-SR7001	-	-	
	IDC	-	-	-	

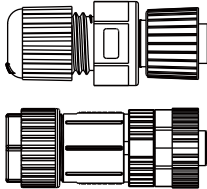
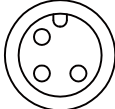
∟ M12 A-coding (Plastic) > Field Installable > Female Connector > Straight

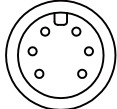
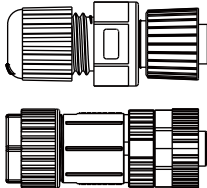
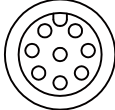
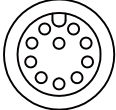
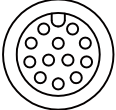
					
Type	Contact Type	4A/250V	4A/250V	4A/60V	2A / 30V
Without Strain Relief	Solder Type	MSAP-03BFFA-SL8001	MSAP-04BFFA-SL8001	MSAP-05BFFA-SL8001	MSAP-08BFFA-SL8001
	Screw Type	MSAP-03BFFB-SL7001	MSAP-04BFFB-SL7001	MSAP-05BFFB-SL7001	MSAP-08BFFB-SL7001
	IDC	-	-	MSAP-05BFFD-SL7001	-
					
Type	Contact Type	2A / 30V	1.5A / 30V	1.5A / 30V	
Without Strain Relief	Solder Type	MSAP-08BFFA-SL8001	MSAP-10BFFA-SL7001	MSAP-12BFFA-SL7001	
	Screw Type	MSAP-08BFFB-SL7001	-	-	
	IDC	-	-	-	

* Design and specification are subject to change without notice.

∟ M12 B-Coded (Shielded) > Receptacle > Male Connector > Front Fastened

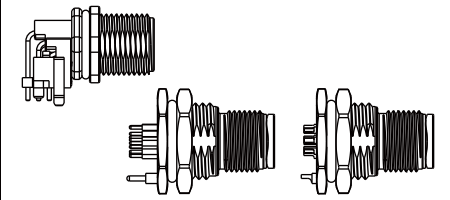
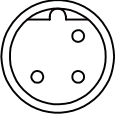
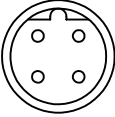
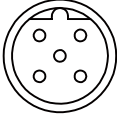
				
Type	Mounting Thread	4A/250V	4A/250V	4A/60V
PCB Pin (180°)	PG9	MSBS-03PMMP-SF8001	MSBS-04PMMP-SF8001	MSBS-05PMMP-SF8001
	M16.0	MSBS-03PMMP-SF8002	MSBS-04PMMP-SF8002	MSBS-05PMMP-SF8002
PCB Pin (90°)	M12	-	-	MSBS-05PMMP-SF7003
Solder Pin (180°)	PG9	MSBS-03PMMS-SF8001	MSBS-04PMMS-SF8001	MSBS-05PMMS-SF8001
	M16.0	MSBS-03PMMS-SF8002	MSBS-04PMMS-SF8002	MSBS-05PMMS-SF8002

∟ M12 B-Coded (Shielded) > Receptacle > Female Connector > Front Fastened

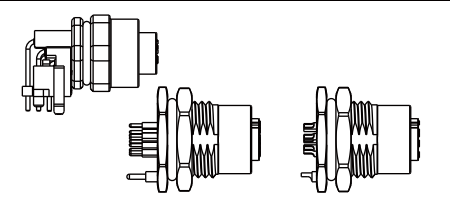
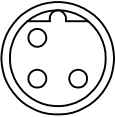
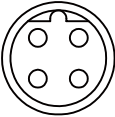
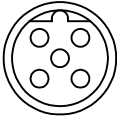

				
Type	Mounting Thread	4A/250V	4A/250V	4A/60V
PCB Pin (180°)	PG9	MSBS-03PFFP-SF8001	MSBS-04PFFP-SF8001	MSBS-05PFFP-SF8001
	M16.0	MSBS-03PFFP-SF8002	MSBS-04PFFP-SF8002	MSBS-05PFFP-SF8002
PCB Pin (90°)	M12	-	-	MSBS-05PFFR-SF7003
Solder Pin (180°)	PG9	MSBS-03PFFS-SF8001	MSBS-04PFFS-SF8001	MSBS-05PFFS-SF8001
	M16.0	MSBS-03PFFS-SF8002	MSBS-04PFFS-SF8002	MSBS-05PFFS-SF8002

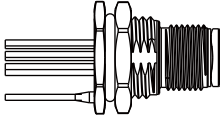
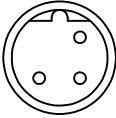
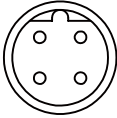
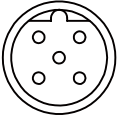
∟ **M12 B-Coded (Shielded) > Receptacle with Wire Harness > Male Connector > Front Fastened**

				
Backshell: Hexagonal				
Wire Length (UL1007)*	Mounting Thread	4A/250V	4A/250V	4A/60V
150mm	PG9	MSBS-03PMMC-SF8B15	MSBS-04PMMC-SF8B15	MSBS-05PMMC-SF8B15
	M16.0	MSBS-03PMMC-SF8C15	MSBS-04PMMC-SF8C15	MSBS-05PMMC-SF8C15
300mm	PG9	MSBS-03PMMC-SF8B30	MSBS-04PMMC-SF8B30	MSBS-05PMMC-SF8B30
	M16.0	MSBS-03PMMC-SF8C30	MSBS-04PMMC-SF8C30	MSBS-05PMMC-SF8C30
500mm	PG9	MSBS-03PMMC-SF8B50	MSBS-04PMMC-SF8B50	MSBS-05PMMC-SF8B50
	M16.0	MSBS-03PMMC-SF8C50	MSBS-04PMMC-SF8C50	MSBS-05PMMC-SF8C50
1000mm	PG9	MSBS-03PMMC-SF8BA0	MSBS-04PMMC-SF8BA0	MSBS-05PMMC-SF8BA0
	M16.0	MSBS-03PMMC-SF8CA0	MSBS-04PMMC-SF8CA0	MSBS-05PMMC-SF8CA0
1500mm	PG9	MSBS-03PMMC-SF8BA5	MSBS-04PMMC-SF8BA5	MSBS-05PMMC-SF8BA5
	M16.0	MSBS-03PMMC-SF8CA5	MSBS-04PMMC-SF8CA5	MSBS-05PMMC-SF8CA5

* Other wire types are available upon request.

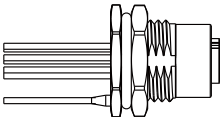
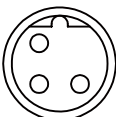
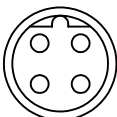
∟ **M12 B-Coded (Shielded) > Receptacle with Wire Harness > Female Connector > Front Fastened**

				
Backshell: Hexagonal				
Wire Length (UL1007)*	Mounting Thread	4A/250V	4A/250V	4A/60V
150mm	PG9	MSBS-03PFFC-SF8B15	MSBS-04PFFC-SF8B15	MSBS-05PFFC-SF8B15
	M16.0	MSBS-03PFFC-SF8C15	MSBS-04PFFC-SF8C15	MSBS-05PFFC-SF8C15
300mm	PG9	MSBS-03PFFC-SF8B30	MSBS-04PFFC-SF8B30	MSBS-05PFFC-SF8B30
	M16.0	MSBS-03PFFC-SF8C30	MSBS-04PFFC-SF8C30	MSBS-05PFFC-SF8C30
500mm	PG9	MSBS-03PFFC-SF8B50	MSBS-04PFFC-SF8B50	MSBS-05PFFC-SF8B50
	M16.0	MSBS-03PFFC-SF8C50	MSBS-04PFFC-SF8C50	MSBS-05PFFC-SF8C50
1000mm	PG9	MSBS-03PFFC-SF8BA0	MSBS-04PFFC-SF8BA0	MSBS-05PFFC-SF8BA0
	M16.0	MSBS-03PFFC-SF8CA0	MSBS-04PFFC-SF8CA0	MSBS-05PFFC-SF8CA0
1500mm	PG9	MSBS-03PFFC-SF8BA5	MSBS-04PFFC-SF8BA5	MSBS-05PFFC-SF8BA5
	M16.0	MSBS-03PFFC-SF8CA5	MSBS-04PFFC-SF8CA5	MSBS-05PFFC-SF8CA5

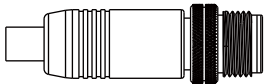
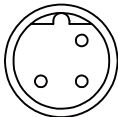
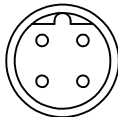
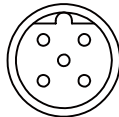

* Other wire types are available upon request.

∟ M12 B-Coded (Shielded) > Overmolded with cable > Male Connector
> Straight

			
Type	4A/250V	4A/250V	4A/60V
Without Strain Relief	-	-	MSBS-05BMMM-SL7XXX

* XXX: Choose the cable type and length:
 - PVC: 1M (A01) / 2M (A02) / 5M (A05) / 10M (A10)
 - PU: 1M (B01) / 2M (B02) / 5M (B05) / 10M (B10)

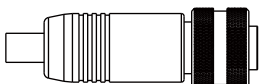
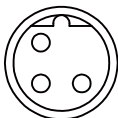
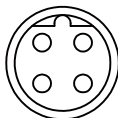
∟ M12 B-Coded (Shielded) > Overmolded with cable > Female Connector
> Straight

			
Type	4A/250V	4A/250V	4A/60V
Without Strain Relief	-	-	MSBS-05BFFM-SL7XXX

* XXX: Choose the cable type and length:
 - PVC: 1M (A01) / 2M (A02) / 5M (A05) / 10M (A10)
 - PU: 1M (B01) / 2M (B02) / 5M (B05) / 10M (B10)



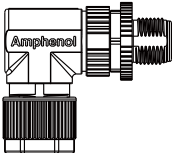
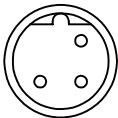
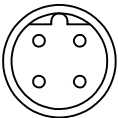
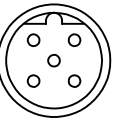

∟ M12 B-Coded (Shielded) > Field Installable > Male Connector > Right Angle

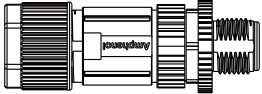
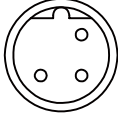
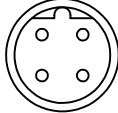
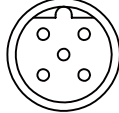
				
Type	Contact Type	4A/250V	4A/250V	4A/60V
Without Strain Relief	Screw Type	-	-	MSBS-05BMMB-SR7001

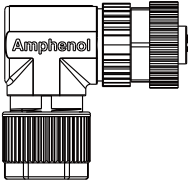

∟ **M12 B-Coded (Shielded) > Field Installable > Male Connector > Straight**

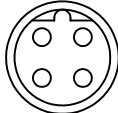
				
Type	Contact Type	4A/250V	4A/250V	4A/60V
Without Strain Relief	Screw Type	-	-	MSBS-05BMMB-SL7001

∟ **M12 B-Coded (Shielded) > Field Installable > Female Connector > Right Angle**

				
Type	Contact Type	4A/250V	4A/250V	4A/250V
Without Strain Relief	Screw Type	-	-	MSBS-05BFFB-SR7001

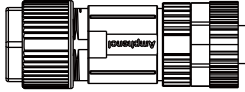
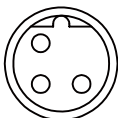
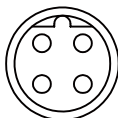
∟ **M12 B-Coded (Shielded) > Field Installable > Female Connector > Straight**

				
Type	Contact Type	4A/250V	4A/250V	4A/250V
Without Strain Relief	Screw Type	-	-	MSBS-05BFFB-SR7001

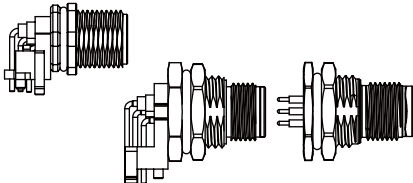
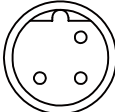
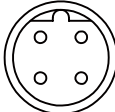
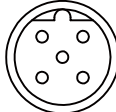

∟ M12 B-Code (Metal Nut) > Receptacle > Male Connector > Front Fastened

 <p>Backshell: Hexagonal</p>				
Type	Mounting Thread	4A/250V	4A/250V	4A/60V
PCB Pin (180°)	PG9	M12B-03PMMP-SF8001	M12B-04PMMP-SF8001	M12B-05PMMP-SF8001
	M16.0	M12B-03PMMP-SF8002	M12B-04PMMP-SF8001	M12B-05PMMP-SF8001
PCB Pin (90°)	M12	-	-	M12B-05PMMR-SF7003
	PG9	-	-	M12B-05PMMR-SF8001
	M16.0	-	-	M12B-05PMMR-SF8002
Solder Pin (180°)	PG9	M12B-03PMMS-SF8001	M12B-04PMMS-SF8001	M12B-05PMMS-SF8001
	M16.0	M12B-03PMMS-SF8002	M12B-04PMMS-SF8002	M12B-05PMMS-SF8002

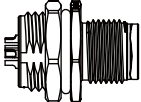
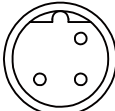
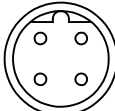
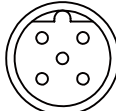

∟ M12 B-Code (Metal Nut) > Receptacle > Male Connector > Front Fastened

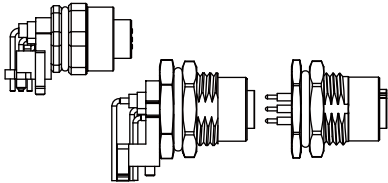
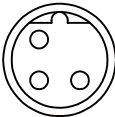
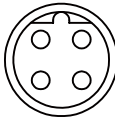
				
Type	Mounting Thread	4A/250V	4A/250V	4A/60V
Solder Pin (180°)	PG9	M12B-03PMMS-SH8001	M12B-04PMMS-SH8001	M12B-05PMMS-SH8001
	M16.0	M12B-03PMMS-SH8002	M12B-04PMMS-SH8002	M12B-05PMMS-SH8002

∟ M12 B-Code (Metal Nut) > Receptacle > Female Connector > Front Fastened

 <p>Backshell: Hexagonal</p>				
Type	Mounting Thread	4A/250V	4A/250V	4A/60V
PCB Pin (180°)	PG9	M12B-03PFFP-SF8001	M12B-04PFFP-SF8001	M12B-05PFFP-SF8001
	M16.0	M12B-03PFFP-SF8002	M12B-04PFFP-SF8001	M12B-05PFFP-SF8001
PCB Pin (90°)	M12	-	-	M12B-05PFFR-SF7003
	PG9	-	-	M12B-05PFFR-SF8001
	M16.0	-	-	M12B-05PFFR-SF8002
Solder Pin (180°)	PG9	M12B-03PFFS-SF8001	M12B-04PFFS-SF8001	M12B-05PFFS-SF8001
	M16.0	M12B-03PFFS-SF8002	M12B-04PFFS-SF8002	M12B-05PFFS-SF8002

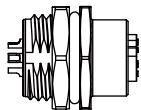
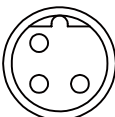
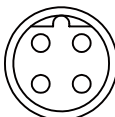
∟ M12 B-Code (Metal Nut) > Receptacle > Female Connector > Rear Fastened

				
Type	Mounting Thread	4A/250V	4A/250V	4A/60V
Solder Pin (180°)	PG9	M12B-03PMMS-SH8001	M12B-04PMMS-SH8001	M12B-05PMMS-SH8001
	M16.0	M12B-03PMMS-SH8002	M12B-04PMMS-SH8002	M12B-05PMMS-SH8002

* Design and specification are subject to change without notice.

➤ M12 B-Code (Metal Nut) > Receptacle with Wire Harness > Male Connector
> Front Fastened

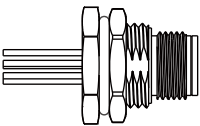
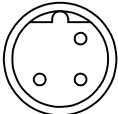
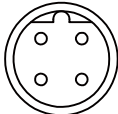
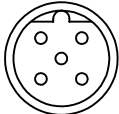
				
Backshell: Hexagonal				
Wire Length (UL1007)*	Mounting Thread	4A/250V	4A/250V	4A/60V
150mm	PG9	M12B-03PMMC-SF8B15	M12B-04PMMC-SF8B15	M12B-05PMMC-SF8B15
	M16.0	M12B-03PMMC-SF8C15	M12B-04PMMC-SF8C15	M12B-05PMMC-SF8C15
300mm	PG9	M12B-03PMMC-SF8B30	M12B-04PMMC-SF8B30	M12B-05PMMC-SF8B30
	M16.0	M12B-03PMMC-SF8C30	M12B-04PMMC-SF8C30	M12B-05PMMC-SF8C30
500mm	PG9	M12B-03PMMC-SF8B50	M12B-04PMMC-SF8B50	M12B-05PMMC-SF8B50
	M16.0	M12B-03PMMC-SF8C50	M12B-04PMMC-SF8C50	M12B-05PMMC-SF8C50
1000mm	PG9	M12B-03PMMC-SF8BA0	M12B-04PMMC-SF8BA0	M12B-05PMMC-SF8BA0
	M16.0	M12B-03PMMC-SF8CA0	M12B-04PMMC-SF8CA0	M12B-05PMMC-SF8CA0
1500mm	PG9	M12B-03PMMC-SF8BA5	M12B-04PMMC-SF8BA5	M12B-05PMMC-SF8BA5
	M16.0	M12B-03PMMC-SF8CA5	M12B-04PMMC-SF8CA5	M12B-05PMMC-SF8CA5

* Other wire types are available upon request.

➤ M12 B-Code (Metal Nut) > Receptacle with Wire Harness > Male Connector
> Front Fastened

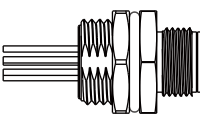
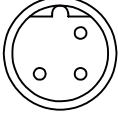
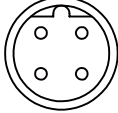
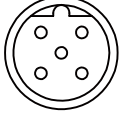
				
Backshell: Hexagonal				
Wire Length (UL1007)*	Mounting Thread	4A/250V	4A/250V	4A/60V
150mm	PG9	M12B-03PMMC-SH8B15	M12B-04PMMC-SH8B15	M12B-05PMMC-SH8B15
	M16.0	M12B-03PMMC-SH8C15	M12B-04PMMC-SH8C15	M12B-05PMMC-SH8C15
300mm	PG9	M12B-03PMMC-SH8B30	M12B-04PMMC-SH8B30	M12B-05PMMC-SH8B30
	M16.0	M12B-03PMMC-SH8C30	M12B-04PMMC-SH8C30	M12B-05PMMC-SH8C30
500mm	PG9	M12B-03PMMC-SH8B50	M12B-04PMMC-SH8B50	M12B-05PMMC-SH8B50
	M16.0	M12B-03PMMC-SH8C50	M12B-04PMMC-SH8C50	M12B-05PMMC-SH8C50
1000mm	PG9	M12B-03PMMC-SH8BA0	M12B-04PMMC-SH8BA0	M12B-05PMMC-SH8BA0
	M16.0	M12B-03PMMC-SH8CA0	M12B-04PMMC-SH8CA0	M12B-05PMMC-SH8CA0
1500mm	PG9	M12B-03PMMC-SH8BA5	M12B-04PMMC-SH8BA5	M12B-05PMMC-SH8BA5
	M16.0	M12B-03PMMC-SH8CA5	M12B-04PMMC-SH8CA5	M12B-05PMMC-SH8CA5

* Other wire types are available upon request.

∨ M12 B-Code (Metal Nut) > Receptacle with Wire Harness > Female Connector > Front Fastened

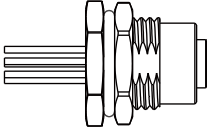
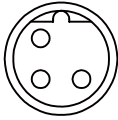
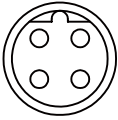
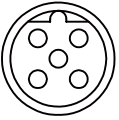
				
Backshell: Hexagonal				
Wire Length (UL1007)*	Mounting Thread	4A/250V	4A/250V	4A/60V
150mm	PG9	M12B-03PFFC-SF8B15	M12B-04PFFC-SF8B15	M12B-05PFFC-SF8B15
	M16.0	M12B-03PFFC-SF8C15	M12B-04PFFC-SF8C15	M12B-05PFFC-SF8C15
300mm	PG9	M12B-03PFFC-SF8B30	M12B-04PFFC-SF8B30	M12B-05PFFC-SF8B30
	M16.0	M12B-03PFFC-SF8C30	M12B-04PFFC-SF8C30	M12B-05PFFC-SF8C30
500mm	PG9	M12B-03PFFC-SF8B50	M12B-04PFFC-SF8B50	M12B-05PFFC-SF8B50
	M16.0	M12B-03PFFC-SF8C50	M12B-04PFFC-SF8C50	M12B-05PFFC-SF8C50
1000mm	PG9	M12B-03PFFC-SF8BA0	M12B-04PFFC-SF8BA0	M12B-05PFFC-SF8BA0
	M16.0	M12B-03PFFC-SF8CA0	M12B-04PFFC-SF8CA0	M12B-05PFFC-SF8CA0
1500mm	PG9	M12B-03PFFC-SF8BA5	M12B-04PFFC-SF8BA5	M12B-05PFFC-SF8BA5
	M16.0	M12B-03PFFC-SF8CA5	M12B-04PFFC-SF8CA5	M12B-05PFFC-SF8CA5

∨ M12 B-Code (Metal Nut) > Receptacle with Wire Harness > Female Connector > Rear Fastened

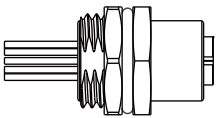
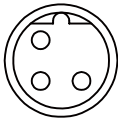
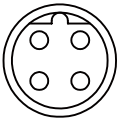
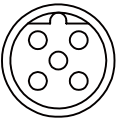
				
Backshell: Hexagonal				
Wire Length (UL1007)*	Mounting Thread	4A/250V	4A/250V	4A/60V
150mm	PG9	M12B-03PFFC-SH8B15	M12B-04PFFC-SH8B15	M12B-05PFFC-SH8B15
	M16.0	M12B-03PFFC-SH8C15	M12B-04PFFC-SH8C15	M12B-05PFFC-SH8C15
300mm	PG9	M12B-03PFFC-SH8B30	M12B-04PFFC-SH8B30	M12B-05PFFC-SH8B30
	M16.0	M12B-03PFFC-SH8C30	M12B-04PFFC-SH8C30	M12B-05PFFC-SH8C30
500mm	PG9	M12B-03PFFC-SH8B50	M12B-04PFFC-SH8B50	M12B-05PFFC-SH8B50
	M16.0	M12B-03PFFC-SH8C50	M12B-04PFFC-SH8C50	M12B-05PFFC-SH8C50
1000mm	PG9	M12B-03PFFC-SH8BA0	M12B-04PFFC-SH8BA0	M12B-05PFFC-SH8BA0
	M16.0	M12B-03PFFC-SH8CA0	M12B-04PFFC-SH8CA0	M12B-05PFFC-SH8CA0
1500mm	PG9	M12B-03PFFC-SH8BA5	M12B-04PFFC-SH8BA5	M12B-05PFFC-SH8BA5
	M16.0	M12B-03PFFC-SH8CA5	M12B-04PFFC-SH8CA5	M12B-05PFFC-SH8CA5

* Design and specification are subject to change without notice.

M12 B-code (Metal Nut)

Overmolded with cable > Male Connector

Receptacle | Unmated
Overmolded with Cable | Mated
Field Installable | Mated

➤ **M12 B-Code (Metal Nut) > Overmolded with cable > Male Connector > Right Angle**

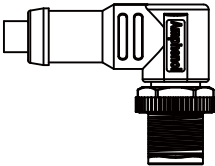
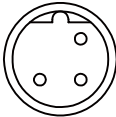
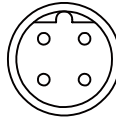
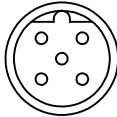
			
Type	4A/250V	4A/250V	4A/60V
Without Strain Relief	M12B-03BMMM-SR8XXX*	M12B-04BMMM-SR8XXX*	M12B-05BMMM-SR8XXX*

* XXX: Choose the cable type and length:

- PVC(UL2517 Yellow): 1M (A01) / 2M (A02) / 5M (A05) / 10M (A10)
- PU(UL20549 Black): 1M (B01) / 2M (B02) / 5M (B05) / 10M (B10)
- PVC(UL2517 Black): 1M (D01) / 2M (D02) / 5M (D05) / 10M (D10)

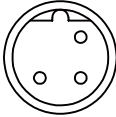
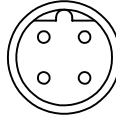
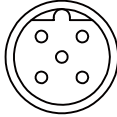

➤ **M12 B-Code (Metal Nut) > Overmolded with cable > Male Connector > Straight**

			
Type	4A/250V	4A/250V	4A/60V
Without Strain Relief	M12B-03BMMM-SL8XXX*	M12B-04BMMM-SL8XXX*	M12B-05BMMM-SL8XXX*

* XXX: Choose the cable type and length:

- PVC(UL2517 Yellow): 1M (A01) / 2M (A02) / 5M (A05) / 10M (A10)
- PU(UL20549 Black): 1M (B01) / 2M (B02) / 5M (B05) / 10M (B10)
- PVC(UL2517 Black): 1M (D01) / 2M (D02) / 5M (D05) / 10M (D10)

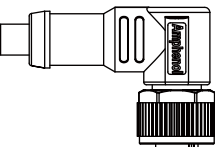
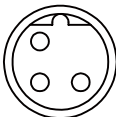
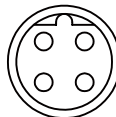

➤ **M12 B-Code (Metal Nut) > Overmolded with cable > Female Connector > Right Angle**

			
Type	4A/250V	4A/250V	4A/60V
Without Strain Relief	M12B-03BMMM-SR8XXX*	M12B-04BMMM-SR8XXX*	M12B-05BMMM-SR8XXX*

* XXX: Choose the cable type and length:

- PVC(UL2517 Yellow): 1M (A01) / 2M (A02) / 5M (A05) / 10M (A10)
- PU(UL20549 Black): 1M (B01) / 2M (B02) / 5M (B05) / 10M (B10)
- PVC(UL2517 Black): 1M (D01) / 2M (D02) / 5M (D05) / 10M (D10)

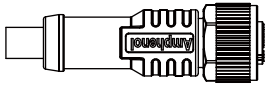
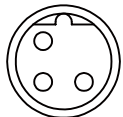
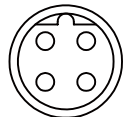

∟ **M12 B-Code (Metal Nut) > Overmolded with cable > Female Connector > Straight**

			
Type	4A/250V	4A/250V	4A/60V
Without Strain Relief	M12B-03BFFM-SL8XXX*	M12B-04BFFM-SL8XXX*	M12B-05BFFM-SL8XXX*

* XXX: Choose the cable type and length:

- PVC(UL2517 Yellow): 1M (A01) / 2M (A02) / 5M (A05) / 10M (A10)
- PU(UL20549 Black): 1M (B01) / 2M (B02) / 5M (B05) / 10M (B10)
- PVC(UL2517 Black): 1M (D01) / 2M (D02) / 5M (D05) / 10M (D10)

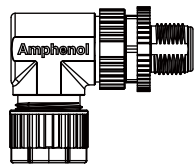
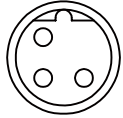
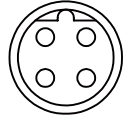
∟ **M12 B-Code (Metal Nut) > Overmolded with cable > Female Connector > Straight**

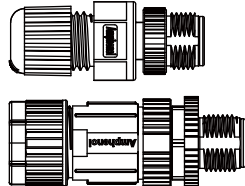
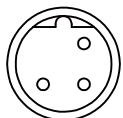
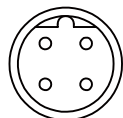
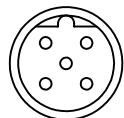

				
Type	Contact Type	4A/250V	4A/250V	4A/60V
Without Strain Relief	Screw Type	-	-	M12B-05BMMB-SR7001

∟ **M12 B-Code (Metal Nut) > Field Installable > Male Connector > Straight**

				
Type	Contact Type	4A/250V	4A/250V	4A/60V
Without Strain Relief	Solder Type	M12B-03BMMB-SL8001	M12B-04BMMB-SL8001	M12B-05BMMB-SL8001
	Screw Type	-	-	M12B-05BMMB-SL7001

* Design and specification are subject to change without notice.

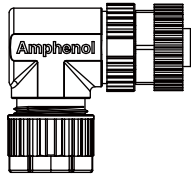
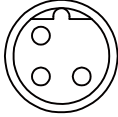
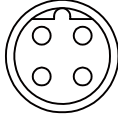
∟ M12 B-Code (Metal Nut) > Field Installable > Female Connector
> Right Angle

				
Type	Contact Type	4A/250V	4A/250V	4A/60V
Without Strain Relief	Screw Type	-	-	M12B-05BFFB-SR7001

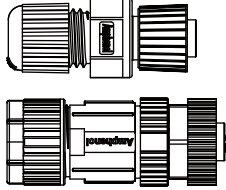
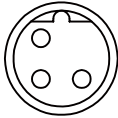
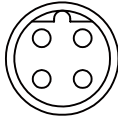
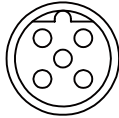

∟ M12 B-Code (Metal Nut) > Field Installable > Female Connector > Straight

				
Type	Contact Type	4A/250V	4A/250V	4A/60V
Without Strain Relief	Screw Type	-	-	M12B-05BFFB-SR7001

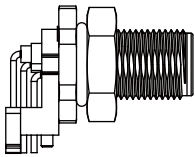
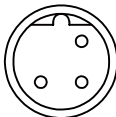
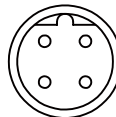
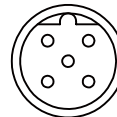
∟ **M12 B-Code (Plastic) > Receptacle > Male Connector > Front Fastened**

				
Backshell: Hexagonal				
Type	Mounting Thread	4A/60V	4A/60V	4A/60V
PCB Pin (90°)	M12	-	-	MSBP-05PMMR-SF8003

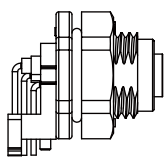
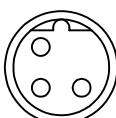
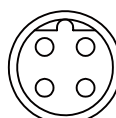
∟ **M12 B-Code (Plastic) > Receptacle > Female Connector > Front Fastened**

				
Backshell: Hexagonal				
Type	Mounting Thread	4A/60V	4A/60V	4A/60V
PCB Pin (90°)	M12	-	-	MSBP-05PMMR-SF8003

∟ **M12 B-Code (Plastic) > Overmolded with cable > Male Connector > Right Angle**

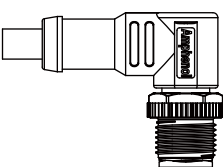
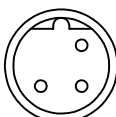
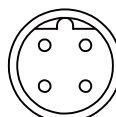
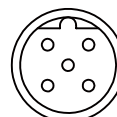
				
Type		4A/250V	4A/250V	4A/250V
Without Strain Relief		MSBP-03BMMM-SR8XXX*	MSBP-04BMMM-SR8XXX*	MSBP-05BMMM-SR8XXX*

* XXX: Choose the cable type and length:
 - PVC (UL2517 Yellow): 1M (A01) / 2M (A02) / 5M (A05) / 10M (A10)
 - PU (UL20549 Black): 1M (B01) / 2M (B02) / 5M (B05) / 10M (B10)
 - PVC (UL2517 Black): 1M (D01) / 2M (D02) / 5M (D05) / 10M (D10)

* Design and specification are subject to change without notice.

M12 B-code (Plastic)

Overmolded with cable > Male / Female Connector

IP 67 . 68 9

Receptacle | Unmated
Overmolded with Cable | Mated
Field Installable | Mated

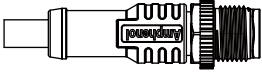
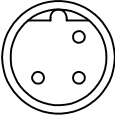
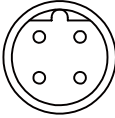
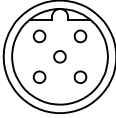

∟ **M12 B-Code (Plastic) > Overmolded with cable > Male Connector**
> **Straight**

			
Type	4A/250V	4A/250V	4A/60V
Without Strain Relief	MSBP-03BMMM-SL8XXX*	MSBP-04BMMM-SL8XXX*	MSBP-05BMMM-SL8XXX*

* XXX: Choose the cable type and length:

- PVC (UL2517 Yellow): 1M (A01) / 2M (A02) / 5M (A05) / 10M (A10)
- PU (UL20549 Black): 1M (B01) / 2M (B02) / 5M (B05) / 10M (B10)
- PVC (UL2517 Black): 1M (D01) / 2M (D02) / 5M (D05) / 10M (D10)

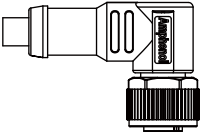
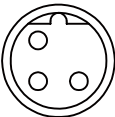
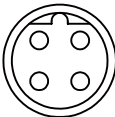
∟ **M12 B-Code (Plastic) > Overmolded with cable > Female Connector**
> **Right Angle**

			
Type	4A/250V	4A/250V	4A/60V
Without Strain Relief	MSBP-03BFFM-SR8XXX*	MSBP-04BFFM-SR8XXX*	MSBP-05BFFM-SR8XXX*

* XXX: Choose the cable type and length:

- PVC (UL2517 Yellow): 1M (A01) / 2M (A02) / 5M (A05) / 10M (A10)
- PU (UL20549 Black): 1M (B01) / 2M (B02) / 5M (B05) / 10M (B10)
- PVC (UL2517 Black): 1M (D01) / 2M (D02) / 5M (D05) / 10M (D10)

∟ **M12 B-Code (Plastic) > Overmolded with cable > Female Connector**
> **Straight**

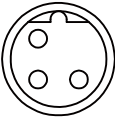
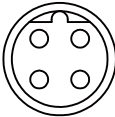
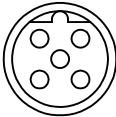
			
Type	4A/250V	4A/250V	4A/60V
Without Strain Relief	MSBP-03BFFM-SL8XXX*	MSBP-04BFFM-SL8XXX*	MSBP-05BFFM-SL8XXX*

* XXX: Choose the cable type and length:

- PVC (UL2517 Yellow): 1M (A01) / 2M (A02) / 5M (A05) / 10M (A10)
- PU (UL20549 Black): 1M (B01) / 2M (B02) / 5M (B05) / 10M (B10)
- PVC (UL2517 Black): 1M (D01) / 2M (D02) / 5M (D05) / 10M (D10)

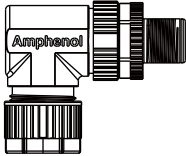
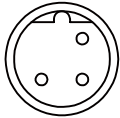
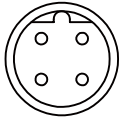
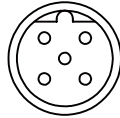

∟ **M12 B-Code (Plastic) > Field Installable > Male Connector > Right Angle**

				
Type	Contact Type	4A/250V	4A/250V	4A/60V
Without Strain Relief	Screw Type	-	-	MSBP-05BMMB-SR7001

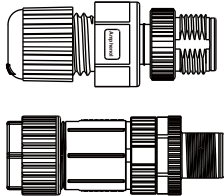
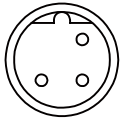
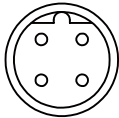
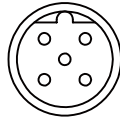
∟ **M12 B-Code (Plastic) > Field Installable > Male Connector > Straight**

				
Type	Contact Type	4A/250V	4A/250V	4A/60V
Without Strain Relief	Solder Type	-	-	MSBP-05BMMB-SL8001
	Screw Type	-	-	MSBP-05BMMB-SL7001

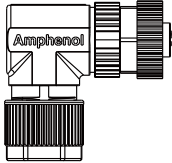
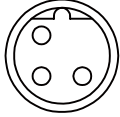
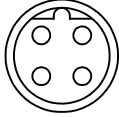
∟ **M12 B-Coded (Plastic) > Field Installable > Female Connector > Right Angle**

				
Type	Contact Type	4A/250V	4A/250V	4A/60V
Without Strain Relief	Solder Type	-	-	MSBP-05BMMB-SL8001
	Screw Type	-	-	MSBP-05BMMB-SL7001

* Design and specification are subject to change without notice.



M12 B-code (Plastic)

Field Installable > Female Connector

IP 67 . 68 9

Receptacle | Unmated
Overmolded with Cable | Mated
Field Installable | Mated

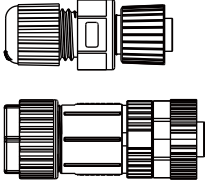
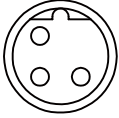
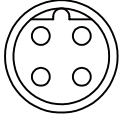

∟ **M12 B-Coded (Plastic) > Field Installable > Female Connector > Straight**

				
Without Strain Relief	Solder Type	-	-	MSBP-05BFFB-SL8001
	Screw Type	-	-	MSBP-05BFFB-SL7001

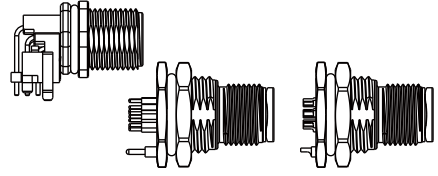
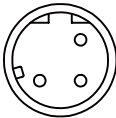
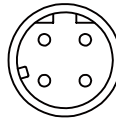
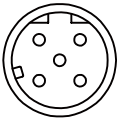
∟ **M12 D-Code (Shielded) > Receptacle > Male Connector > Front Fastened**

				
Backshell: Hexagonal				
Type	Mounting Thread	4A/250V	4A/250V	4A/60V
PCB Pin (180°)	PG9	MSDS-03PMMP-SF8001	MSDS-04PMMP-SF8001	MSDS-05PMMP-SF8001
	M16.0	MSDS-03PMMP-SF8002	MSDS-04PMMP-SF8002	MSDS-05PMMP-SF8002
PCB Pin (90°)	M12	-	MSDS-04PMMR-SF7003	-
Solder Pin (180°)	PG9	MSDS-03PMMS-SF8001	MSDS-04PMMS-SF8001	MSDS-05PMMS-SF8001
	M16.0	MSDS-03PMMS-SF8002	MSDS-04PMMS-SF8002	MSDS-05PMMS-SF8002

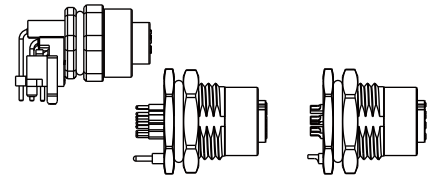
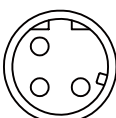
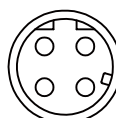
∟ **M12 D-Code (Shielded) > Receptacle > Female Connector > Front Fastened**

				
Backshell: Hexagonal				
Type	Mounting Thread	4A/250V	4A/250V	4A/60V
PCB Pin (180°)	PG9	MSDS-03PFFP-SF8001	MSDS-04PFFP-SF8001	MSDS-05PFFP-SF8001
	M16.0	MSDS-03PFFP-SF8002	MSDS-04PFFP-SF8002	MSDS-05PFFP-SF8002
PCB Pin (90°)	M12	-	MSDS-04PFFP-SF7003	-
Solder Pin (180°)	PG9	MSDS-03PFFP-SF8001	MSDS-04PFFP-SF8001	MSDS-05PFFS-SF8001
	M16.0	MSDS-03PFFP-SF8002	MSDS-04PFFP-SF8002	MSDS-05PFFS-SF8002

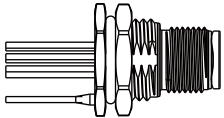
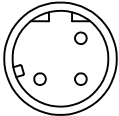
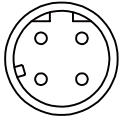
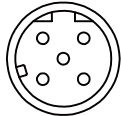

* Design and specification are subject to change without notice.

∟ M12 D-Code (Shielded) > Receptacle with Wire Harness > Male Connector
> Front Fastened

				
Backshell: Hexagonal				
Wire Length (UL1007)*	Mounting Thread	4A/250V	4A/250V	4A/60V
150mm	PG9	MSDS-03PMMC-SF8B15	MSDS-04PMMC-SF8B15	MSDS-05PMMC-SF8B15
	M16.0	MSDS-03PMMC-SF8C15	MSDS-04PMMC-SF8C15	MSDS-05PMMC-SF8C15
300mm	PG9	MSDS-03PMMC-SF8B30	MSDS-04PMMC-SF8B30	MSDS-05PMMC-SF8B30
	M16.0	MSDS-03PMMC-SF8C30	MSDS-04PMMC-SF8C30	MSDS-05PMMC-SF8C30
500mm	PG9	MSDS-03PMMC-SF8B50	MSDS-04PMMC-SF8B50	MSDS-05PMMC-SF8B50
	M16.0	MSDS-03PMMC-SF8C50	MSDS-04PMMC-SF8C50	MSDS-05PMMC-SF8C50
1000mm	PG9	MSDS-03PMMC-SF8BA0	MSDS-04PMMC-SF8BA0	MSDS-05PMMC-SF8BA0
	M16.0	MSDS-03PMMC-SF8CA0	MSDS-04PMMC-SF8CA0	MSDS-05PMMC-SF8CA0
1500mm	PG9	MSDS-03PMMC-SF8BA5	MSDS-04PMMC-SF8BA5	MSDS-05PMMC-SF8BA5
	M16.0	MSDS-03PMMC-SF8CA5	MSDS-04PMMC-SF8CA5	MSDS-05PMMC-SF8CA5

* Other wire types are available upon request.

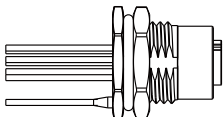
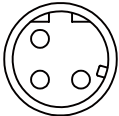
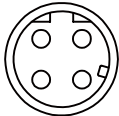
∟ M12 D-Code (Shielded) > Receptacle with Wire Harness > Female Connector
> Front Fastened

				
Backshell: Hexagonal				
Wire Length (UL1007)*	Mounting Thread	4A/250V	4A/250V	4A/60V
150mm	PG9	MSDS-03PFFC-SF8B15	MSDS-04PFFC-SF8B15	MSDS-05PFFC-SF8B15
	M16.0	MSDS-03PFFC-SF8C15	MSDS-04PFFC-SF8C15	MSDS-05PFFC-SF8C15
300mm	PG9	MSDS-03PFFC-SF8B30	MSDS-04PFFC-SF8B30	MSDS-05PFFC-SF8B30
	M16.0	MSDS-03PFFC-SF8C30	MSDS-04PFFC-SF8C30	MSDS-05PFFC-SF8C30
500mm	PG9	MSDS-03PFFC-SF8B50	MSDS-04PFFC-SF8B50	MSDS-05PFFC-SF8B50
	M16.0	MSDS-03PFFC-SF8C50	MSDS-04PFFC-SF8C50	MSDS-05PFFC-SF8C50
1000mm	PG9	MSDS-03PFFC-SF8BA0	MSDS-04PFFC-SF8BA0	MSDS-05PFFC-SF8BA0
	M16.0	MSDS-03PFFC-SF8CA0	MSDS-04PFFC-SF8CA0	MSDS-05PFFC-SF8CA0
1500mm	PG9	MSDS-03PFFC-SF8BA5	MSDS-04PFFC-SF8BA5	MSDS-05PFFC-SF8BA5
	M16.0	MSDS-03PFFC-SF8CA5	MSDS-04PFFC-SF8CA5	MSDS-05PFFC-SF8CA5

* Other wire types are available upon request.

∟ M12 D-Code (Shielded) > Overmolded with cable > Male Connector > Straight

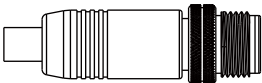
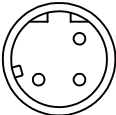
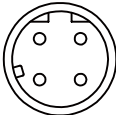
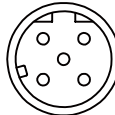
			
Type	4A/250V	4A/250V	4A/60V
Without Strain Relief	-	MSDS-04BMMM-SL7XXX*	-

* XXX: Choose the cable type and length:
 - PVC: 1M (A01) / 2M (A02) / 5M (A05) / 10M (A10)
 - PU: 1M (B01) / 2M (B02) / 5M (B05) / 10M (B10)

∟ M12 D-Code (Shielded) > Overmolded with cable > Female Connector > Straight

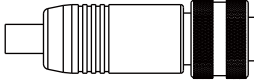
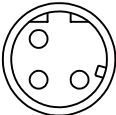
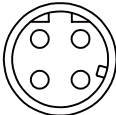
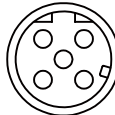
			
Type	4A/250V	4A/250V	4A/60V
Without Strain Relief	-	MSDS-04BFFM-SL7XXX*	-

* XXX: Choose the cable type and length:
 - PVC: 1M (A01) / 2M (A02) / 5M (A05) / 10M (A10)
 - PU: 1M (B01) / 2M (B02) / 5M (B05) / 10M (B10)

* Design and specification are subject to change without notice.

∟ M12 D-Code (Shielded) > Field Installable > Male Connector > Right Angle

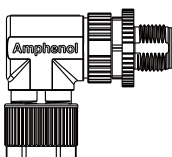
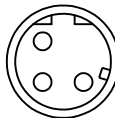
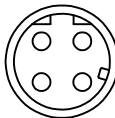
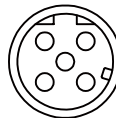
				
Type	Contact Type	4A/250V	4A/250V	4A/60V
Without Strain Relief	Screw Type	-	MSDS-04BMMB-SR7001	-

∟ M12 D-Code (Shielded) > Field Installable > Male Connector > Straight

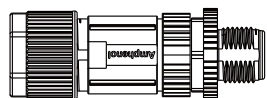
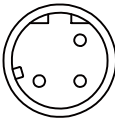
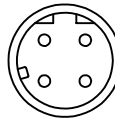
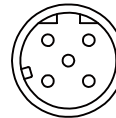
				
Type	Contact Type	4A/250V	4A/250V	4A/60V
Without Strain Relief	Screw Type	-	MSDS-04BMMB-SL7001	-

∟ M12 D-Code (Shielded) > Field Installable > Female Connector > Right Angle

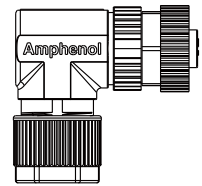
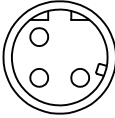
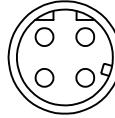
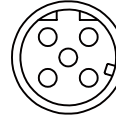
				
Type	Contact Type	4A/250V	4A/250V	4A/60V
Without Strain Relief	Screw Type	-	MSDS-04BMMB-SL7001	-

∟ M12 D-Code (Shielded) > Field Installable > Female Connector > Straight

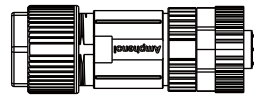
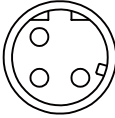
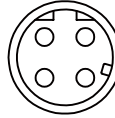
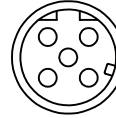
				
Type	Contact Type	4A/250V	4A/250V	4A/60V
Without Strain Relief	Screw Type	-	MSDS-04BFFB-SL7001	-

∟ M12 D-Code (Metal Nut) > Receptacle > Male Connector > Front Fastened

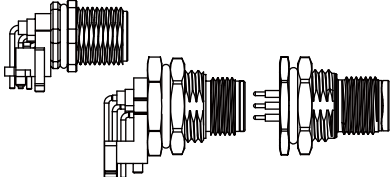
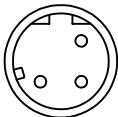
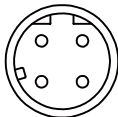
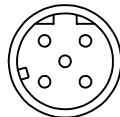
				
Backshell: Hexagonal				
Type	Mounting Thread	4A/250V	4A/250V	4A/60V
PCB Pin (180°)	PG9	M12D-03PMMP-SF8001	M12D-04PMMP-SF8001	M12D-05PMMP-SF8001
	M16.0	M12D-03PMMP-SF8002	M12D-04PMMP-SF8001	M12D-05PMMP-SF8001
PCB Pin (90°)	M12	-	M12D-04PMMR-SF7003	-
	PG9	-	M12D-04PMMR-SF8001	-
	M16.0	-	M12D-04PMMR-SF8002	-
Solder Pin (180°)	PG9	M12D-03PMMS-SF8001	M12D-04PMMS-SF8001	M12D-05PMMS-SF8001
	M16.0	M12D-03PMMS-SF8002	M12D-04PMMS-SF8002	M12D-05PMMS-SF8002

∟ M12 D-Code (Metal Nut) > Receptacle > Male Connector > Rear Fastened

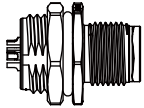
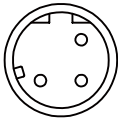
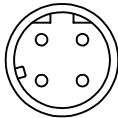
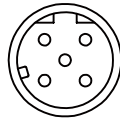

				
Type	Mounting Thread	4A/250V	4A/250V	4A/60V
Solder Pin (180°)	PG9	M12D-03PMMS-SH8001	M12D-04PMMS-SH8001	M12D-05PMMS-SH8001
	M16.0	M12D-03PMMS-SH8002	M12D-04PMMS-SH8002	M12D-05PMMS-SH8002

* Design and specification are subject to change without notice.

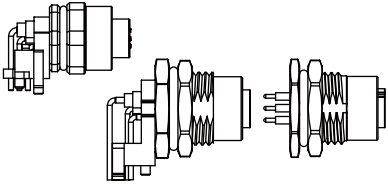
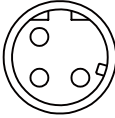
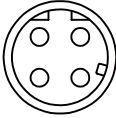
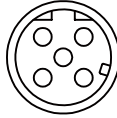
≧ M12 D-Code (Metal Nut) > Receptacle > Female Connector > Front Fastened

				
Backshell: Hexagonal				
Type	Mounting Thread	4A/250V	4A/250V	4A/60V
PCB Pin (180°)	PG9	M12D-03PFFP-SF8001	M12D-04PFFP-SF8001	M12D-05PFFP-SF8001
	M16.0	M12D-03PFFP-SF8002	M12D-04PFFP-SF8001	M12D-05PFFP-SF8001
PCB Pin (90°)	M12	-	M12D-04PFFR-SF7003	-
	PG9	-	M12D-04PFFR-SF8001	-
	M16.0	-	M12D-04PFFR-SF8002	-
Solder Pin (180°)	PG9	M12D-03PFFS-SF8001	M12D-04PFFS-SF8001	M12D-05PFFS-SF8001
	M16.0	M12D-03PFFS-SF8002	M12D-04PFFS-SF8002	M12D-05PFFS-SF8002

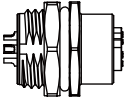
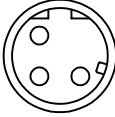
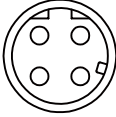
≧ M12 D-Code (Metal Nut) > Receptacle > Female Connector > Front Fastened

				
Type	Mounting Thread	4A/250V	4A/250V	4A/60V
Solder Pin (180°)	PG9	M12D-03PFFS-SH8001	M12D-04PFFS-SH8001	M12D-05PFFS-SH8001
	M16.0	M12D-03PFFS-SH8002	M12D-04PFFS-SH8002	M12D-05PFFS-SH8002

∟ **M12 D-Code (Metal Nut) > Receptacle with Wire Harness > Male Connector > Front Fastened**

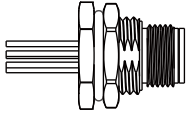
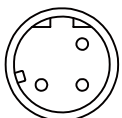
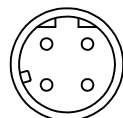
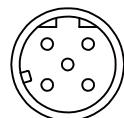
				
Backshell: Hexagonal				
Wire Length (UL1007)*	Mounting Thread	4A/250V	4A/250V	4A/60V
150mm	PG9	M12D-03PMMC-SF8B15	M12D-04PMMC-SF8B15	M12D-05PMMC-SF8B15
	M16.0	M12D-03PMMC-SF8C15	M12D-04PMMC-SF8C15	M12D-05PMMC-SF8C15
300mm	PG9	M12D-03PMMC-SF8B30	M12D-04PMMC-SF8B30	M12D-05PMMC-SF8B30
	M16.0	M12D-03PMMC-SF8C30	M12D-04PMMC-SF8C30	M12D-05PMMC-SF8C30
500mm	PG9	M12D-03PMMC-SF8B50	M12D-04PMMC-SF8B50	M12D-05PMMC-SF8B50
	M16.0	M12D-03PMMC-SF8C50	M12D-04PMMC-SF8C50	M12D-05PMMC-SF8C50
1000mm	PG9	M12D-03PMMC-SF8BA0	M12D-04PMMC-SF8BA0	M12D-05PMMC-SF8BA0
	M16.0	M12D-03PMMC-SF8CA0	M12D-04PMMC-SF8CA0	M12D-05PMMC-SF8CA0
1500mm	PG9	M12D-03PMMC-SF8BA5	M12D-04PMMC-SF8BA5	M12D-05PMMC-SF8BA5
	M16.0	M12D-03PMMC-SF8CA5	M12D-04PMMC-SF8CA5	M12D-05PMMC-SF8CA5

* Other wire types are available upon request.

∟ **M12 D-Code (Metal Nut) > Receptacle with Wire Harness > Male Connector > Rear Fastened**

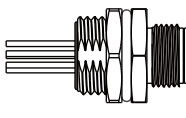
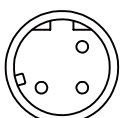
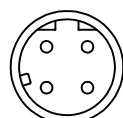
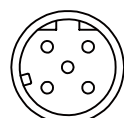
				
Backshell: Hexagonal				
Wire Length (UL1007)*	Mounting Thread	4A/250V	4A/250V	4A/60V
150mm	PG9	M12D-03PMMC-SH8B15	M12D-04PMMC-SH8B15	M12D-05PMMC-SH8B15
	M16.0	M12D-03PMMC-SH8C15	M12D-04PMMC-SH8C15	M12D-05PMMC-SH8C15
300mm	PG9	M12D-03PMMC-SH8B30	M12D-04PMMC-SH8B30	M12D-05PMMC-SH8B30
	M16.0	M12D-03PMMC-SH8C30	M12D-04PMMC-SH8C30	M12D-05PMMC-SH8C30
500mm	PG9	M12D-03PMMC-SH8B50	M12D-04PMMC-SH8B50	M12D-05PMMC-SH8B50
	M16.0	M12D-03PMMC-SH8C50	M12D-04PMMC-SH8C50	M12D-05PMMC-SH8C50
1000mm	PG9	M12D-03PMMC-SH8BA0	M12D-04PMMC-SH8BA0	M12D-05PMMC-SH8BA0
	M16.0	M12D-03PMMC-SH8CA0	M12D-04PMMC-SH8CA0	M12D-05PMMC-SH8CA0
1500mm	PG9	M12D-03PMMC-SH8BA5	M12D-04PMMC-SH8BA5	M12D-05PMMC-SH8BA5
	M16.0	M12D-03PMMC-SH8CA5	M12D-04PMMC-SH8CA5	M12D-05PMMC-SH8CA5

* Other wire types are available upon request.

* Design and specification are subject to change without notice.

M12 D-Code (Metal Nut)

Receptacle with Wire Harness > Female Connector

IP 67 . 68 9

Receptacle | Unmated
Overmolded with Cable | Mated
Field Installable | Mated

∟ M12 D-Code (Metal Nut) > Receptacle with Wire Harness > Female Connector > Front Fastened

Backshell: Hexagonal				
Wire Length (UL1007)*	Mounting Thread	4A/250V	4A/250V	4A/60V
150mm	PG9	M12D-03PFFC-SF8B15	M12D-04PFFC-SF8B15	M12D-05PFFC-SF8B15
	M16.0	M12D-03PFFC-SF8C15	M12D-04PFFC-SF8C15	M12D-05PFFC-SF8C15
300mm	PG9	M12D-03PFFC-SF8B30	M12D-04PFFC-SF8B30	M12D-05PFFC-SF8B30
	M16.0	M12D-03PFFC-SF8C30	M12D-04PFFC-SF8C30	M12D-05PFFC-SF8C30
500mm	PG9	M12D-03PFFC-SF8B50	M12D-04PFFC-SF8B50	M12D-05PFFC-SF8B50
	M16.0	M12D-03PFFC-SF8C50	M12D-04PFFC-SF8C50	M12D-05PFFC-SF8C50
1000mm	PG9	M12D-03PFFC-SF8BA0	M12D-04PFFC-SF8BA0	M12D-05PFFC-SF8BA0
	M16.0	M12D-03PFFC-SF8CA0	M12D-04PFFC-SF8CA0	M12D-05PFFC-SF8CA0
1500mm	PG9	M12D-03PFFC-SF8BA5	M12D-04PFFC-SF8BA5	M12D-05PFFC-SF8BA5
	M16.0	M12D-03PFFC-SF8CA5	M12D-04PFFC-SF8CA5	M12D-05PFFC-SF8CA5

* Other wire types are available upon request.

∟ M12 D-Code (Metal Nut) > Receptacle with Wire Harness > Female Connector > Rear Fastened

Backshell: Hexagonal				
Wire Length (UL1007)*	Mounting Thread	4A/250V	4A/250V	4A/60V
150mm	PG9	M12D-03PFFC-SH8B15	M12D-04PFFC-SH8B15	M12D-05PFFC-SH8B15
	M16.0	M12D-03PFFC-SH8C15	M12D-04PFFC-SH8C15	M12D-05PFFC-SH8C15
300mm	PG9	M12D-03PFFC-SH8B30	M12D-04PFFC-SH8B30	M12D-05PFFC-SH8B30
	M16.0	M12D-03PFFC-SH8C30	M12D-04PFFC-SH8C30	M12D-05PFFC-SH8C30
500mm	PG9	M12D-03PFFC-SH8B50	M12D-04PFFC-SH8B50	M12D-05PFFC-SH8B50
	M16.0	M12D-03PFFC-SH8C50	M12D-04PFFC-SH8C50	M12D-05PFFC-SH8C50
1000mm	PG9	M12D-03PFFC-SH8BA0	M12D-04PFFC-SH8BA0	M12D-05PFFC-SH8BA0
	M16.0	M12D-03PFFC-SH8CA0	M12D-04PFFC-SH8CA0	M12D-05PFFC-SH8CA0
1500mm	PG9	M12D-03PFFC-SH8BA5	M12D-04PFFC-SH8BA5	M12D-05PFFC-SH8BA5
	M16.0	M12D-03PFFC-SH8CA5	M12D-04PFFC-SH8CA5	M12D-05PFFC-SH8CA5

* Other wire types are available upon request.

∟ **M12 D-Code (Metal Nut) > Overmolded with cable > Male Connector**
 > Right Angle

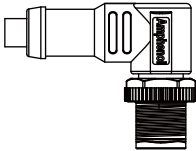
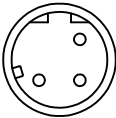
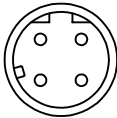
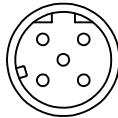
			
Type	4A/250V	4A/250V	4A/60V
Without Strain Relief	M12D-03BMMM-SR8XXX*	M12D-04BMMM-SR8XXX*	M12D-05BMMM-SR8XXX*

* XXX: Choose the cable type and length:

- PVC(UL2517 Yellow): 1M (A01) / 2M (A02) / 5M (A05) / 10M (A10)
- PU(UL20549 Black): 1M (B01) / 2M (B02) / 5M (B05) / 10M (B10)
- PVC(UL2517 Black): 1M (D01) / 2M (D02) / 5M (D05) / 10M (D10)

∟ **M12 D-Code (Metal Nut) > Overmolded with cable > Male Connector**
 > Straight

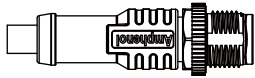
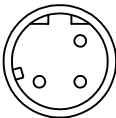
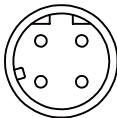
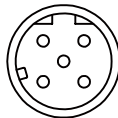
			
Type	4A/250V	4A/250V	4A/60V
Without Strain Relief	M12D-03BMMM-SL8XXX*	M12D-04BMMM-SL8XXX*	M12D-05BMMM-SL8XXX*

* XXX: Choose the cable type and length:

- PVC(UL2517 Yellow): 1M (A01) / 2M (A02) / 5M (A05) / 10M (A10)
- PU(UL20549 Black): 1M (B01) / 2M (B02) / 5M (B05) / 10M (B10)
- PVC(UL2517 Black): 1M (D01) / 2M (D02) / 5M (D05) / 10M (D10)

∟ **M12 D-Code (Metal Nut) > Overmolded with cable > Female Connector**
 > Right Angle

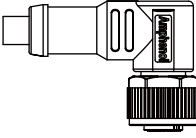
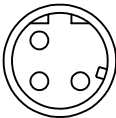
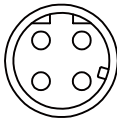
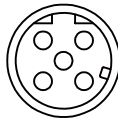
			
Type	4A/250V	4A/250V	4A/60V
Without Strain Relief	M12D-03BFFM-SR8XXX*	M12D-04BFFM-SR8XXX*	M12D-05BFFM-SR8XXX*

* XXX: Choose the cable type and length:

- PVC(UL2517 Yellow): 1M (A01) / 2M (A02) / 5M (A05) / 10M (A10)
- PU(UL20549 Black): 1M (B01) / 2M (B02) / 5M (B05) / 10M (B10)
- PVC(UL2517 Black): 1M (D01) / 2M (D02) / 5M (D05) / 10M (D10)

* Design and specification are subject to change without notice.

M12 D-Code (Metal Nut)

Overmolded with cable > Male / Female Connector

IP 65 . 67 9

Receptacle | Unmated
Overmolded with Cable | Mated
Field Installable | Mated

➤ **M12 D-Code (Metal Nut) > Overmolded with cable > Female Connector > Straight**

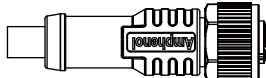
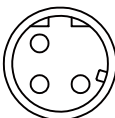
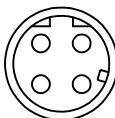
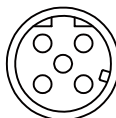
			
Type	4A/250V	4A/250V	4A/60V
Without Strain Relief	M12D-03BFFM-SL8XXX*	M12D-04BFFM-SL8XXX*	M12D-05BFFM-SL8XXX*

* XXX: Choose the cable type and length:

- PVC(UL2517 Yellow): 1M (A01) / 2M (A02) / 5M (A05) / 10M (A10)
- PU(UL20549 Black): 1M (B01) / 2M (B02) / 5M (B05) / 10M (B10)
- PVC(UL2517 Black): 1M (D01) / 2M (D02) / 5M (D05) / 10M (D10)

➤ **M12 D-Code (Metal Nut) > Field Installable > Male Connector > Right Angle**

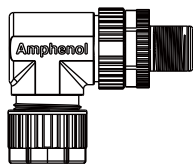
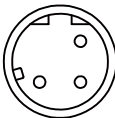
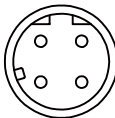
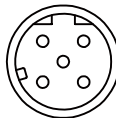
			
Type	4A/250V	4A/250V	4A/60V
Without Strain Relief	-	M12D-04BMMB-SR7001	-

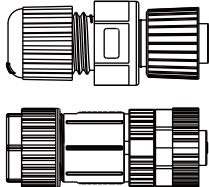
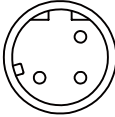
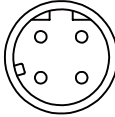
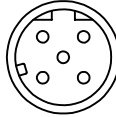

➤ **M12 D-Code (Metal Nut) > Field Installable > Male Connector > Straight**

				
Type	Contact Type	4A/250V	4A/250V	4A/60V
Without Strain Relief	Solder Type	M12D-03BMMA-SL8001	M12D-04BMMA-SL8001	M12D-05BMMA-SL8001
	Screw Type	-	M12D-04BMMB-SL7001	-

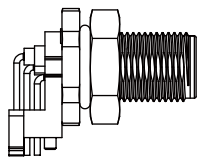
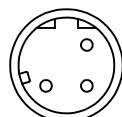
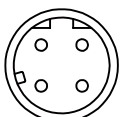
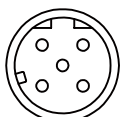
≧ M12 D-Code (Plastic) > Receptacle > Male Connector > Front Fastened

				
Backshell: Hexagonal				
Type	Mounting Thread	4A/250V	4A/250V	4A/60V
PCB Pin (90°)	M12	-	MSDP-04PMMR-SF8003	-

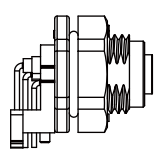
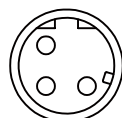
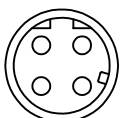
≧ M12 D-Code (Plastic) > Receptacle > Female Connector > Front Fastened

				
Backshell: Hexagonal				
Type	Mounting Thread	4A/250V	4A/250V	4A/60V
PCB Pin (90°)	M16	-	MSDP-04PFFR-SF8002	-

≧ M12 D-Code (Plastic) > Receptacle > Female Connector > Front Fastened

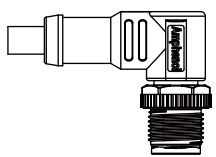
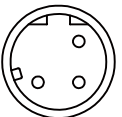
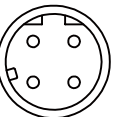
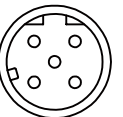
				
Type		4A/250V	4A/250V	4A/60V
Without Strain Relief		MSDP-03BMMM-SR8XXX*	MSDP-04BMMM-SR8XXX*	MSDP-05BMMM-SR8XXX*

* XXX: Choose the cable type and length:

- PVC (UL2517 Yellow): 1M (A01) / 2M (A02) / 5M (A05) / 10M (A10)
- PU (UL20549 Black): 1M (B01) / 2M (B02) / 5M (B05) / 10M (B10)
- PVC (UL2517 Black): 1M (D01) / 2M (D02) / 5M (D05) / 10M (D10)

M12 D-Code (Plastic)

Overmolded with cable > Male / Female Connector

IP 65 . 67 9

Receptacle | Unmated
Overmolded with Cable | Mated
Field Installable | Mated

➤ **M12 D-Code (Plastic) > Overmolded with cable > Male Connector > Straight**

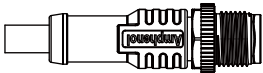
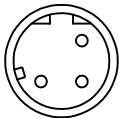
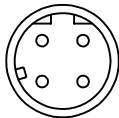
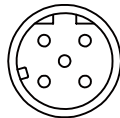
			
Type	4A/250V	4A/250V	4A/60V
Without Strain Relief	MSDP-03BMMM-SL8XXX*	MSDP-04BMMM-SL8XXX*	MSDP-05BMMM-SL8XXX*

* XXX: Choose the cable type and length:

- PVC (UL2517 Yellow): 1M (A01) / 2M (A02) / 5M (A05) / 10M (A10)
- PU (UL20549 Black): 1M (B01) / 2M (B02) / 5M (B05) / 10M (B10)
- PVC (UL2517 Black): 1M (D01) / 2M (D02) / 5M (D05) / 10M (D10)

➤ **M12 D-Code (Plastic) > Overmolded with cable > Female Connector > Right Angle**

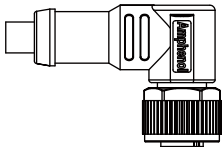
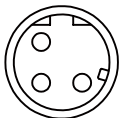
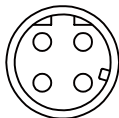
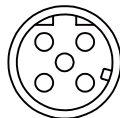
			
Type	4A/250V	4A/250V	4A/60V
Without Strain Relief	MSDP-03BFFM-SR8XXX*	MSDP-04BFFM-SR8XXX*	MSDP-05BFFM-SR8XXX*

* XXX: Choose the cable type and length:

- PVC (UL2517 Yellow): 1M (A01) / 2M (A02) / 5M (A05) / 10M (A10)
- PU (UL20549 Black): 1M (B01) / 2M (B02) / 5M (B05) / 10M (B10)
- PVC (UL2517 Black): 1M (D01) / 2M (D02) / 5M (D05) / 10M (D10)

➤ **M12 D-Code (Plastic) > Overmolded with cable > Female Connector > Straight**

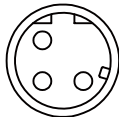
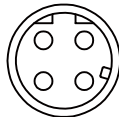
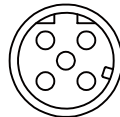
			
Type	4A/250V	4A/250V	4A/60V
Without Strain Relief	MSDP-03BFFM-SR8XXX*	MSDP-04BFFM-SR8XXX*	MSDP-05BFFM-SR8XXX*

* XXX: Choose the cable type and length:

- PVC (UL2517 Yellow): 1M (A01) / 2M (A02) / 5M (A05) / 10M (A10)
- PU (UL20549 Black): 1M (B01) / 2M (B02) / 5M (B05) / 10M (B10)
- PVC (UL2517 Black): 1M (D01) / 2M (D02) / 5M (D05) / 10M (D10)



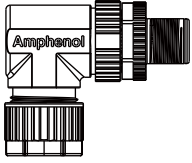
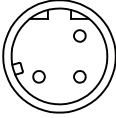
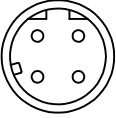
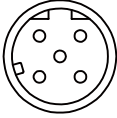

∟ **M12 D-Code (Plastic) > Field Installable > Male Connector > Right Angle**

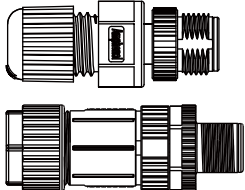
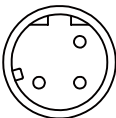
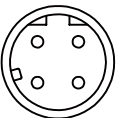
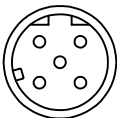
				
Type	Contact Type	4A/250V	4A/250V	4A/60V
Without Strain Relief	Screw Type	-	MSDP-04BMMB-SR7001	-

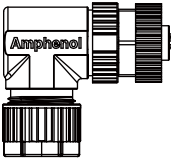

∟ **M12 D-Code (Plastic) > Field Installable > Male Connector > Straight**

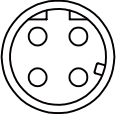
				
Type	Contact Type	4A/250V	4A/250V	4A/60V
Without Strain Relief	Screw Type	-	MSDP-04BMMB-SR7001	-

∟ **M12 D-Code (Plastic) > Field Installable > Female Connector > Right Angle**

				
Type	Contact Type	4A/250V	4A/250V	4A/60V
Without Strain Relief	Screw Type	-	MSDP-04BMMB-SR7001	-

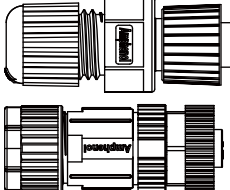
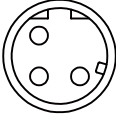
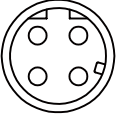

∟ **M12 D-Code (Plastic) > Field Installable > Female Connector > Straight**

				
Type	Contact Type	4A/250V	4A/250V	4A/60V
Without Strain Relief	Solder Type	MSDP-03BFFA-SL8001	MSDP-04BFFA-SL8001	MSDP-05BFFA-SL8001
	Screw Type	-	MSDP-04BFFB-SL7001	-

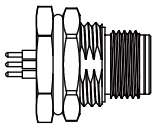
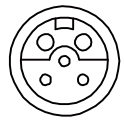

∟ M12 I Style (Metal) > Receptacle > Male Connector (Housing) > Front Fastened (Male+Female Contact)

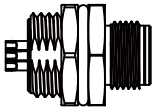
	
Backshell: Hexagonal	
Type	4A/60V
PCB Pin (180°)	M12I-05PMIP-SF8001
	M12I-05PMIP-SF8002
Solder Pin (180°)	M12I-05PMIS-SF8001
	M12I-05PMIS-SF8002

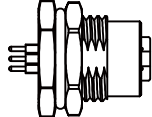

∟ M12 I Style (Metal) > Receptacle > Male Connector (Housing) > Rear Fastened (Male+Female Contact)

	
Backshell: Hexagonal	
Type	4A/60V
Solder Pin (180°)	M12I-05PMIS-SH8001
	M12I-05PMIS-SH8002

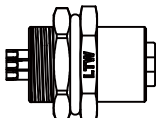

∟ M12 I Style (Metal) > Receptacle > Female Connector (Housing) > Front Fastened (Male+Female Contact)

	
Backshell: Hexagonal	
Type	4A/60V
PCB Pin (180°)	M12I-05PFIP-SF8001
	M12I-05PFIP-SF8002
Solder Pin (180°)	M12I-05PFIS-SF8001
	M12I-05PFIS-SF8002

∟ M12 I Style (Metal) > Receptacle > Female Connector (Housing) > Rear Fastened (Male+Female Contact)

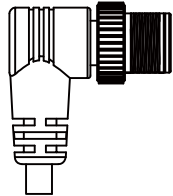

	
Backshell: Hexagonal	
Type	4A/60V
Solder Pin (180°)	M12I-05PFIS-SH8001
	M12I-05PFIS-SH8002

∟ M12 I Style (Metal) > Overmolded with cable > Male Connector (Housing) > Right Angle (Male+Female Contact)

	
Type	4A/60V
With Strain Relief	M12I-05AMIM-SR7XXX*
Without Strain Relief	M12I-05BMIM-SR8XXX*

* XXX: Choose the cable type and length:
 - PVC: 1M (A01) / 2M (A02) / 5M (A05) / 10M (A10)
 - PU: 1M (B01) / 2M (B02) / 5M (B05) / 10M (B10)

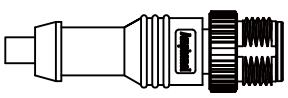

∟ M12 I Style (Metal) > Overmolded with cable > Male Connector (Housing) > Straight (Male+Female Contact)

	
Type	4A/60V
With Strain Relief	M12I-05AMIM-SL7XXX*
Without Strain Relief	M12I-05AMIM-SL8XXX*

* XXX: Choose the cable type and length:
 - PVC: 1M (A01) / 2M (A02) / 5M (A05) / 10M (A10)
 - PU: 1M (B01) / 2M (B02) / 5M (B05) / 10M (B10)

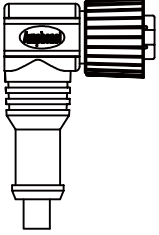

* Design and specification are subject to change without notice.

∟ M12 I Style (Metal) > Overmolded with cable > Female Connector (Housing)
> Right Angle (Male+Female Contact)

	
Type	4A/60V
With Strain Relief	M12I-05AFIM-SR7XXX*
Without Strain Relief	M12I-05BFIM-SR8XXX*

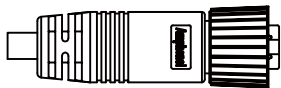

* XXX: Choose the cable type and length:
 - PVC: 1M (A01) / 2M (A02) / 5M (A05) / 10M (A10)
 - PU: 1M (B01) / 2M (B02) / 5M (B05) / 10M (B10)

∟ M12 I Style (Metal) > Overmolded with cable > Female Connector (Housing)
> Straight (Male+Female Contact)

	
Type	4A/60V
With Strain Relief	M12I-05AFIM-SL7XXX*
Without Strain Relief	M12I-05AFIM-SL8XXX*

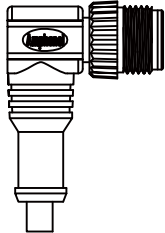

* XXX: Choose the cable type and length:
 - PVC: 1M (A01) / 2M (A02) / 5M (A05) / 10M (A10)
 - PU: 1M (B01) / 2M (B02) / 5M (B05) / 10M (B10)

∟ **M12 I Style (Plastic) > Overmolded with cable > Male Connector (Housing)
> Right Angle (Male+Female Contact)**

	
Type	4A/60V
Without Strain Relief	MSIP-05BMIM-SR8 <u>XXX</u> *

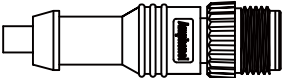

* XXX: Choose the cable type and length:
 - PVC: 1M (A01) / 2M (A02) / 5M (A05) / 10M (A10)
 - PU: 1M (B01) / 2M (B02) / 5M (B05) / 10M (B10)

∟ **M12 I Style (Plastic) > Overmolded with cable > Male Connector (Housing)
> Straight (Male+Female Contact)**

	
Type	4A/60V
Without Strain Relief	MSIP-05BMIM-SL8 <u>XXX</u> *

* XXX: Choose the cable type and length:
 - PVC: 1M (A01) / 2M (A02) / 5M (A05) / 10M (A10)
 - PU: 1M (B01) / 2M (B02) / 5M (B05) / 10M (B10)

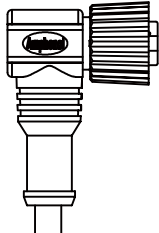
∟ **M12 I Style (Plastic) > Overmolded with cable > Female Connector (Housing)
> Right Angle (Male+Female Contact)**

	
Type	4A/60V
Without Strain Relief	MSIP-05BMIM-SR8 <u>XXX</u> *

* XXX: Choose the cable type and length:
 - PVC: 1M (A01) / 2M (A02) / 5M (A05) / 10M (A10)
 - PU: 1M (B01) / 2M (B02) / 5M (B05) / 10M (B10)

* Design and specification are subject to change without notice.



M12 I Style (Plastic)

Overmolded with cable > Female Connector

IP 67 . 68 9

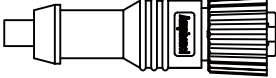

Receptacle | Unmated
Overmolded with Cable | Mated
Field Installable | Mated

∟ **M12 I Style (Plastic) > Overmolded with cable > Female Connector (Housing)
> Straight (Male+Female Contact)**

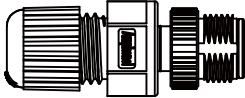

	
Type	4A/60V
Without Strain Relief	MSIP-05BFIM-SL8XXX*

* XXX: Choose the cable type and length:
 - PVC: 1M (A01) / 2M (A02) / 5M (A05) / 10M (A10)
 - PU: 1M (B01) / 2M (B02) / 5M (B05) / 10M (B10)

∟ **M12 I Style (Metal) > Field Installable > Male Connector (Housing)**
> Straight (Male+Female Contact)

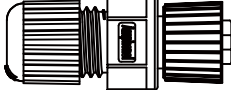

	
Type	4A/60V
Without Strain Relief	M12I-05BMIA-SL8001

∟ **M12 I Style (Metal) > Field Installable > Female Connector (Housing)**
> Straight (Male+Female Contact)

	
Type	4A/60V
Without Strain Relief	M12I-05BFIA-SL8001

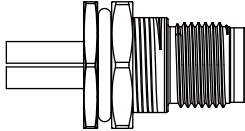

* Design and specification are subject to change without notice.

∟ M12 S-Code (Metal Nut) > Receptacle with Wire Harness > Male Connector
> Front Fastened

		
Backshell: Hexagonal		
Wire Length (UL1007)*	Mounting Thread	12A/630V
150mm	PG9	M12S-04PMMC-SF8B15
	M16.0	M12S-04PMMC-SF8C15
300mm	PG9	M12S-04PMMC-SF8B30
	M16.0	M12S-04PMMC-SF8C30
500mm	PG9	M12S-04PMMC-SF8B50
	M16.0	M12S-04PMMC-SF8C50
1000mm	PG9	M12S-04PMMC-SF8BA0
	M16.0	M12S-04PMMC-SF8CA0
1500mm	PG9	M12S-04PMMC-SF8BA5
	M16.0	M12S-04PMMC-SF8CA5

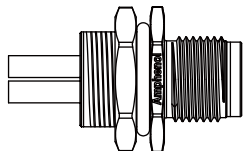

* Other wire types are available upon request.

∟ M12 S-Code (Metal Nut) > Receptacle with Wire Harness > Male Connector
> Rear Fastened

		
Backshell: Hexagonal		
Wire Length (UL1007)*	Mounting Thread	12A/630V
150mm	PG9	M12S-04PMMC-SH8B15
	M16.0	M12S-04PMMC-SH8C15
300mm	PG9	M12S-04PMMC-SH8B30
	M16.0	M12S-04PMMC-SH8C30
500mm	PG9	M12S-04PMMC-SH8B50
	M16.0	M12S-04PMMC-SH8C50
1000mm	PG9	M12S-04PMMC-SH8BA0
	M16.0	M12S-04PMMC-SH8CA0
1500mm	PG9	M12S-04PMMC-SH8BA5
	M16.0	M12S-04PMMC-SH8CA5

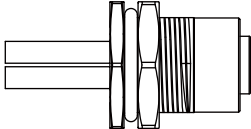

* Other wire types are available upon request.

∟ **M12 S-Code (Metal Nut) > Receptacle with Wire Harness > Female Connector > Front Fastened**

		
Backshell: Hexagonal		
Wire Length (UL1007)*	Mounting Thread	12A/630V
150mm	PG9	M12S-04PFFC-SF8B15
	M16.0	M12S-04PFFC-SF8C15
300mm	PG9	M12S-04PFFC-SF8B30
	M16.0	M12S-04PFFC-SF8C30
500mm	PG9	M12S-04PFFC-SF8B50
	M16.0	M12S-04PFFC-SF8C50
1000mm	PG9	M12S-04PFFC-SF8BA0
	M16.0	M12S-04PFFC-SF8CA0
1500mm	PG9	M12S-04PFFC-SF8BA5
	M16.0	M12S-04PFFC-SF8CA5

* Other wire types are available upon request.

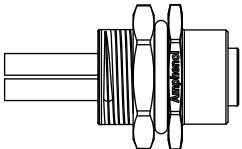
∟ **M12 S-Code (Metal Nut) > Receptacle with Wire Harness > Female Connector > Rear Fastened**

		
Backshell: Hexagonal		
Wire Length (UL1007)*	Mounting Thread	12A/630V
150mm	PG9	M12S-04PFFC-SH8B15
	M16.0	M12S-04PFFC-SH8C15
300mm	PG9	M12S-04PFFC-SH8B30
	M16.0	M12S-04PFFC-SH8C30
500mm	PG9	M12S-04PFFC-SH8B50
	M16.0	M12S-04PFFC-SH8C50
1000mm	PG9	M12S-04PFFC-SH8BA0
	M16.0	M12S-04PFFC-SH8CA0
1500mm	PG9	M12S-04PFFC-SH8BA5
	M16.0	M12S-04PFFC-SH8CA5

* Other wire types are available upon request.



M12 S-code (Metal Nut)

Field Installable > Male / Female Connector

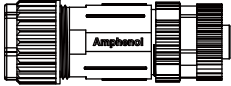

IP 67 . 68 9

Receptacle | Unmated
Overmolded with Cable | Mated
Field Installable | Mated

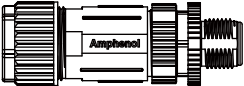

∟ **M12 S-Code (Metal Nut) > Field Installable > Male Connector > Straight**

		
Type	Contact Type	12A/630V
Without Strain Relief	Screw Type	M12S-04BMMB-SL7002

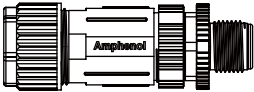

∟ **M12 S-Code (Metal Nut) > Field Installable > Female Connector > Straight**

		
Type	Contact Type	12A/630V
Without Strain Relief	Screw Type	M12S-04BFFB-SL7002

∟ **M12 S-Code (Plastic) > Field Installable > Male Connector > Straight**

		
Type	Contact Type	12A/630V
Without Strain Relief	Screw Type	MSSP-05BMMB-SL7002

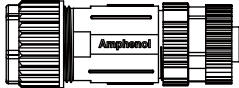
∟ **M12 S-Code (Plastic) > Field Installable > Female Connector > Straight**

		
Type	Contact Type	12A/630V
Without Strain Relief	Screw Type	MSSP-05BMMB-SL7002

* Design and specification are subject to change without notice.



M12 T-code (Metal Nut)

Receptacle with Wire Harness > Male Connector

IP 67 . 68 9

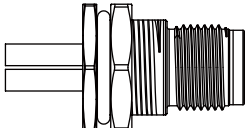

Receptacle | Unmated
Overmolded with Cable | Mated
Field Installable | Mated

**∟ M12 T-Code (Metal Nut) > Receptacle with Wire Harness > Male Connector
> Front Fastened**

		
Backshell: Hexagonal		
Wire Length (UL1007)*	Mounting Thread	4A/60V
150mm	PG9	M12T-04PMMC-SF8B15
	M16.0	M12T-04PMMC-SF8C15
300mm	PG9	M12T-04PMMC-SF8B30
	M16.0	M12T-04PMMC-SF8C30
500mm	PG9	M12T-04PMMC-SF8B50
	M16.0	M12T-04PMMC-SF8C50
1000mm	PG9	M12T-04PMMC-SF8BA0
	M16.0	M12T-04PMMC-SF8CA0
1500mm	PG9	M12T-04PMMC-SF8BA5
	M16.0	M12T-04PMMC-SF8CA5

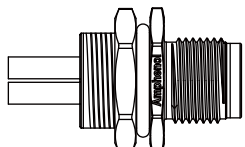

* Other wire types are available upon request.

**∟ M12 T-Code (Metal Nut) > Receptacle with Wire Harness > Male Connector
> Rear Fastened**

		
Backshell: Hexagonal		
Wire Length (UL1007)*	Mounting Thread	4A/60V
150mm	PG9	M12T-04PMMC-SH8B15
	M16.0	M12T-04PMMC-SH8C15
300mm	PG9	M12T-04PMMC-SH8B30
	M16.0	M12T-04PMMC-SH8C30
500mm	PG9	M12T-04PMMC-SH8B50
	M16.0	M12T-04PMMC-SH8C50
1000mm	PG9	M12T-04PMMC-SH8BA0
	M16.0	M12T-04PMMC-SH8CA0
1500mm	PG9	M12T-04PMMC-SH8BA5
	M16.0	M12T-04PMMC-SH8CA5

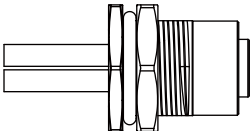

* Other wire types are available upon request.

∟ M12 T-Code (Metal Nut) > Receptacle with Wire Harness > Female Connector > Front Fastened

		
Backshell: Hexagonal		
Wire Length (UL1007)*	Mounting Thread	4A/60V
150mm	PG9	M12T-04PFFC-SF8B15
	M16.0	M12T-04PFFC-SF8C15
300mm	PG9	M12T-04PFFC-SF8B30
	M16.0	M12T-04PFFC-SF8C30
500mm	PG9	M12T-04PFFC-SF8B50
	M16.0	M12T-04PFFC-SF8C50
1000mm	PG9	M12T-04PFFC-SF8BA0
	M16.0	M12T-04PFFC-SF8CA0
1500mm	PG9	M12T-04PFFC-SF8BA5
	M16.0	M12T-04PFFC-SF8CA5

* Other wire types are available upon request.

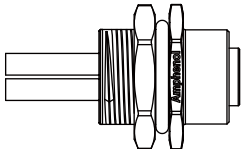
∟ M12 T-Code (Metal Nut) > Receptacle with Wire Harness > Female Connector > Rear Fastened

		
Backshell: Hexagonal		
Wire Length (UL1007)*	Mounting Thread	4A/60V
150mm	PG9	M12T-04PFFC-SH8B15
	M16.0	M12T-04PFFC-SH8C15
300mm	PG9	M12T-04PFFC-SH8B30
	M16.0	M12T-04PFFC-SH8C30
500mm	PG9	M12T-04PFFC-SH8B50
	M16.0	M12T-04PFFC-SH8C50
1000mm	PG9	M12T-04PFFC-SH8BA0
	M16.0	M12T-04PFFC-SH8CA0
1500mm	PG9	M12T-04PFFC-SH8BA5
	M16.0	M12T-04PFFC-SH8CA5

* Other wire types are available upon request.

* Design and specification are subject to change without notice.



M12 T-Code (Metal Nut)

Field Installable > Male / Female Connector

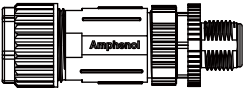

IP 67 . 68 

Receptacle | Unmated
Overmolded with Cable | Mated
Field Installable | Mated

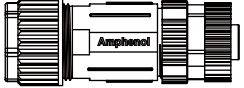

∟ **M12 T-Code (Metal Nut) > Field Installable > Male Connector > Straight**

		
Type	Contact Type	12A/630V
Without Strain Relief	Screw Type	M12T-04BMMB-SL7002

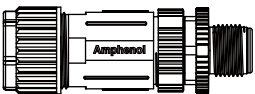

∟ **M12 T-Code (Metal Nut) > Field Installable > Female Connector > Straight**

		
Type	Contact Type	12A/630V
Without Strain Relief	Screw Type	M12T-04BFFB-SL7002

∟ **M12 T-Code (Plastic) > Field Installable > Male Connector > Straight**

		
Type	Contact Type	12A/630V
Without Strain Relief	Screw Type	MSTP-05BMMB-SL7002

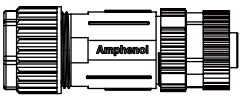
∟ **M12 T-Code (Plastic) > Field Installable > Female Connector > Straight**

		
Type	Contact Type	12A/630V
Without Strain Relief	Screw Type	MSTP-05BFFB-SL7002

* Design and specification are subject to change without notice.



M12 X-Code (Shielded)

Field Installable > Male / Female Connector

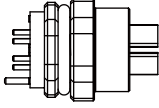

IP 67 . 68 9

Receptacle | Unmated
Overmolded with Cable | Mated
Field Installable | Mated



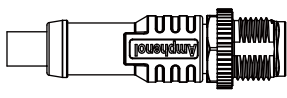

∟ **M12 X-Code (Shielded) > Receptacle > Female Connector > Front Fastened**

		
Type	Mounting Thread	4A/250V
PCB Pin (180°)	M12	MSXS-08PFFFP-SF7001

∟ **M12 X-Code (Shielded) > Overmolded with cable > Male Connector > Straight**

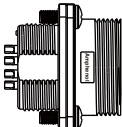

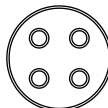
		
Type	0.5/48V	
Without Strain Relief	MSXS-08BMMM-SL8XXX	
Double ended cable	-	

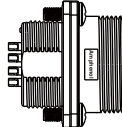
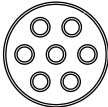
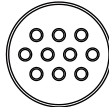
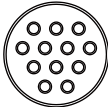
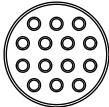
∟ Heavy Duty Shielded Connector (Shielded) > Receptacle > Male Connector (Housing) > Front Fastened

 <p>Backshell: Square Mating style: Screw Thread Mounting Thread: M3*4 pics</p>						
Current Rating & Voltage	Contact Type	Salt Spray Test				
5A/250V	PCB Pin (180°)/Female	48H	-	-	-	-
		500H	-	-	-	-
10A/250V	PCB Pin (180°)/Female	48H	-	-	LB20-04PMFS-SW8001	LB20-05PMFS-SW8001
		500H	-	-	HB20-04PMFS-SW8001	HB20-05PMFS-SW8001
20A/300V	PCB Pin (180°)/Female	48H	LC20-02PMFS-SW8001	LC20-03PMFS-SW8001	-	-
		500H	HC20-02PMFS-SW8001	HC20-03PMFS-SW8001	-	-
 <p>Backshell: Square Mating style: Screw Thread Mounting Thread: M3*4 pics</p>						
Current Rating & Voltage	Contact Type	Salt Spray Test				
5A/250V	PCB Pin (180°)/Female	48H	-	LD20-10PMFS-SW8001	LD20-12PMFS-SW8001	LD20-14PMFS-SW8001
		500H	-	HD20-10PMFS-SW8001	HD20-12PMFS-SW8001	HD20-14PMFS-SW8001
10A/250V	PCB Pin (180°)/Female	48H	LB20-07PMFS-SW8001	-	-	-
		500H	HB20-07PMFS-SW8001	-	-	-
20A/300V	PCB Pin (180°)/Female	48H	-	-	-	-
		500H	-	-	-	-

* Design and specification are subject to change without notice.

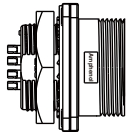
≧ Heavy Duty Shielded Connector (Shielded) > Receptacle > Male Connector (Housing) > Rear Fastened

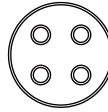
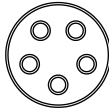
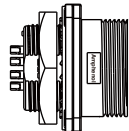
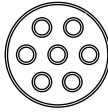
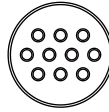
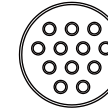
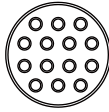
 <p>Backshell: Square Mating style: Screw Thread With Nut Mounting Thread: M20</p>						
Current Rating & Voltage	Contact Type	Salt Spray Test				
5A/250V	PCB Pin (180°) / Female	48H 500H	- -	- -	- -	- -
10A/250V	PCB Pin (180°) / Female	48H 500H	- -	- -	LB20-04PMFS-SN8001 HB20-04PMFS-SN8001	LB20-05PMFS-SN8001 HB20-05PMFS-SN8001
20A/300V	PCB Pin (180°) / Female	48H 500H	LC20-02PMFS-SN8001 HC20-02PMFS-SN8001	LC20-03PMFS-SN8001 HC20-03PMFS-SN8001	- -	- -
 <p>Backshell: Square Mating style: Screw Thread With Nut Mounting Thread: M20</p>						
Current Rating & Voltage	Contact Type	Salt Spray Test				
5A/250V	PCB Pin (180°) / Female	48H 500H	- -	LD20-10PMFS-SN8001 HD20-10PMFS-SN8001	LD20-12PMFS-SN8001 HD20-12PMFS-SN8001	LD20-14PMFS-SN8001 HD20-14PMFS-SN8001
10A/250V	PCB Pin (180°) / Female	48H 500H	LB20-07PMFS-SN8001 HB20-07PMFS-SN8001	- -	- -	- -
20A/300V	PCB Pin (180°) / Female	48H 500H	- -	- -	- -	- -

∟ Heavy Duty Shielded Connector (Shielded) > Field Installable > Female Connector (Housing) > Straight

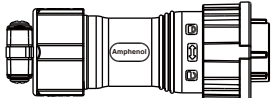
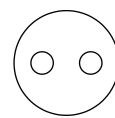
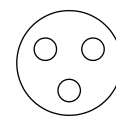
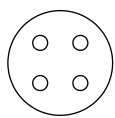
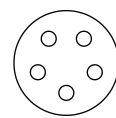
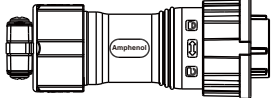
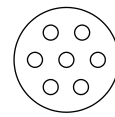
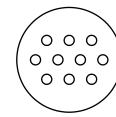
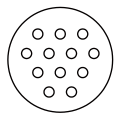
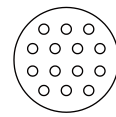
						
Without Strain Relief						
Current Rating & Voltage	Contact Type	Salt Spray Test				
5A/250V	Solder Type / Male	48H	-	-	-	-
		500H	-	-	-	-
10A/250V	Solder Type / Male	48H	-	-	LB20-04BFMA-SL8001	LB20-05BFMA-SL8001
		500H	-	-	HB20-04BFMA-SL8001	HB20-05BFMA-SL8001
20A/300V	Solder Type / Male	48H	LC20-02BFMA-SL8001	LC20-03BFMA-SL8001	-	-
		500H	HC20-02BFMA-SL8001	HC20-03BFMA-SL8001	-	-
						
Without Strain Relief						
Current Rating & Voltage	Contact Type	Salt Spray Test				
5A/250V	Solder Type / Male	48H	-	LD20-10BFMA-SL8001	LD20-12BFMA-SL8001	LD20-14BFMA-SL8001
		500H	-	HD20-10BFMA-SL8001	HD20-12BFMA-SL8001	HD20-14BFMA-SL8001
10A/250V	Solder Type / Male	48H	LB20-07BFMA-SL8001	-	-	-
		500H	HB20-07BFMA-SL8001	-	-	-
20A/300V	Solder Type / Male	48H	-	-	-	-
		500H	-	-	-	-

* Design and specification are subject to change without notice.

M23 (Shielded)

Receptacle (Field Installable Type) > Male Connector

IP 67 . 68 9

Receptacle | Unmated
Overmolded with Cable | Mated
Field Installable | Mated

➤ **M23 (Shielded) > Receptacle (Field Installable Type) > Male Connector (Housing) > Front Fastened**

Backshell: Hexagonal			
Type	Contact Gender	28A/100V	
Crimp Pin	Male	LJ23-06PMMC-SF7001 LJ23-06PMMC-SF7002	

➤ **M23 (Shielded) > Receptacle (Field Installable Type) > Male Connector (Housing) > Front Fastened**

Backshell: Hexagonal			
Type	Contact Gender	28A/100V	
Crimp Pin	Male	LJ23-06PMMC-SF7001 LJ23-06PMMC-SF7002	

➤ **M23 (Shielded) > Field Installable > Female Connector (Housing) > Straight**

Type	Contact Type	Contact Gender	28A/100V
Without Strain Relief	Crimp Pin	Male	LJ23-06DFMC-SL7001 LJ23-06DFMC-SL7002

➤ **M23 (Shielded) > Field Installable > Female Connector (Housing) > Straight**

Type	Contact Type	Contact Gender	28A/100V
Without Strain Relief	Crimp Pin	Male	LJ23-06DFMC-SL7001 LJ23-06DFMC-SL7002