





322/332 Series Lead-free 3AB, Very Fast-acting Fuse



Agency Approvals

Agency	Agency File Number	Ampere Range
	E10480	12A - 30A
	E10480	1A - 10A
	NBK080306-JP1021A/B	1A - 10A
		1A - 30A

Description

The 3AB Very Fast-Acting Fuse for protection of Silicon Controlled Rectifiers and similar solid-state devices.

Features

- In accordance with UL Standard 248-14
- Available in cartridge format only
- RoHS compliant and Lead-free





Applications

Used as supplementary protection in appliance or utilization equipment to provide individual protection for components or internal circuits.

Electrical Characteristics for Series

% of Ampere Rating	Ampere Rating	Opening Time
100%	1 – 30	4 hours, Minimum
250%	1 – 10	.2 second, Maximum
	12 – 30	1 second, Maximum.

Electrical Characteristic Specifications by Item

Amp Code	Ampere Rating (A)	Voltage Rating (V)	Interrupting Rating	Nominal Cold Resistance (Ohms)	Nominal Melting I ² t (A ² sec)	Agency Approvals			
									
001.	1	250	100A@250Vac 100A@125Vdc 200A@72Vdc	0.0927	0.100	x		x	x
1.25	1.25	250		0.0804	0.156	x		x	x
002.	2	250		0.0416	0.560	x		x	x
003.	3	250		0.0245	1.890	x		x	x
004.	4	250		0.0179	3.360	x		x	x
005.	5	250		0.0128	6.250	x		x	x
006.	6	250		0.0117	8.208	x		x	x
007.	7	250		0.0108	10.58	x		x	x
008.	8	250		0.0088	16.45	x		x	x
009.	9	250		0.0077	20.66	x		x	x
010.	10	250	0.0073	24.0	x		x	x	
012.	12	65	200A@65Vac 1000A@65Vdc	0.0515	60.0		x		x
015.	15	65		0.0043	90.0		x		x
020.	20	65		0.0034	192.0		x		x
025.*	25	65		0.0029	325.0		x		x
030.*	30	65		0.0023	540.0		x		x

* Ratings from 1A to 10A are available for 332 series

* Ratings from 12A to 30A are available for 322 series, these ratings are RoHS compliant version.

Temperature Derating Curve

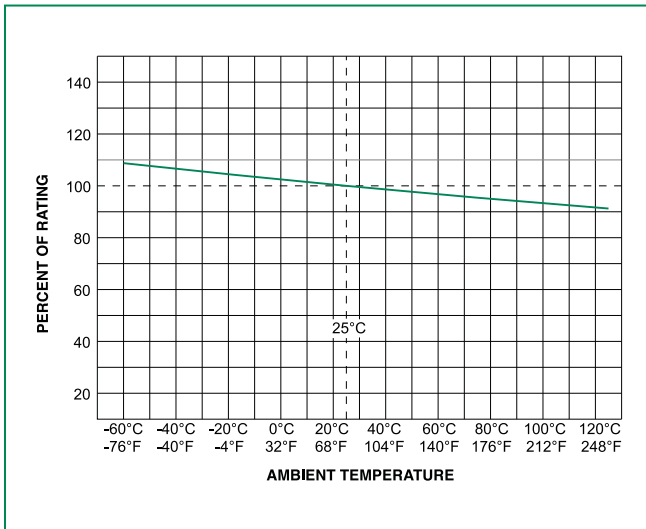

Average Time Current Curves

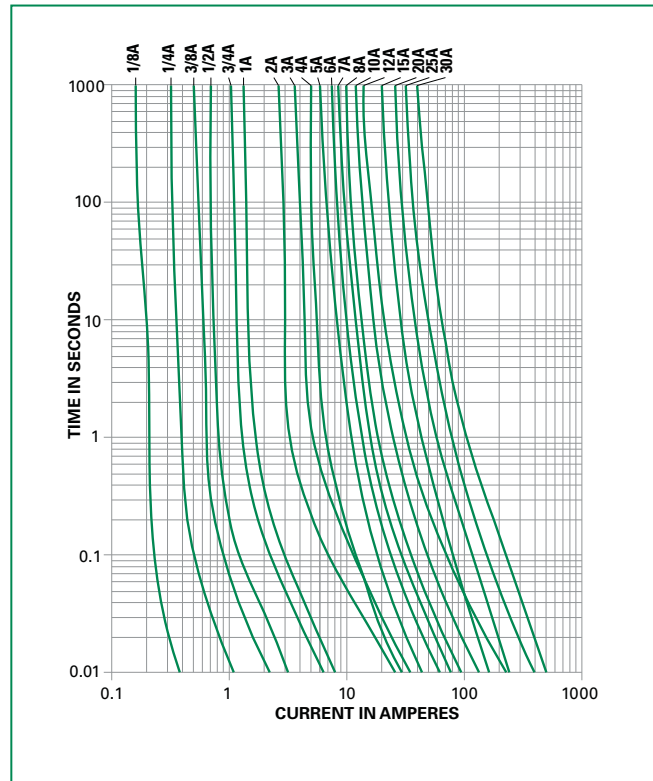

Product Characteristics

Materials	Body: Ceramic Cap: Nickel-plated brass
Terminal Strength	MIL-STD-202G, Method 211A, Test Condition A
Solderability	Reference IEC 60127 Second Edition 2003-01 Annex A
Product Marking	Cap1: Brand logo, current and voltage ratings Cap2: Series and agency approval marks

Operating Temperature	-55°C to +125°C
Thermal Shock	MIL-STD-202G, Method 107G, Test Condition B: (5 cycles -65°C to +125°C)
Vibration	MIL-STD-202G, Method 201 A
Humidity	MIL-STD-202G, Method 103B, Test Condition A: High RH (95%) and Elevated temperature (40°C) for 240 hours
Salt Spray	MIL-STD-202G, Method 101D, Test Condition B

Dimensions

Measurements displayed in millimeters (inches)

322 000P / 332 000P Series (cartridge)

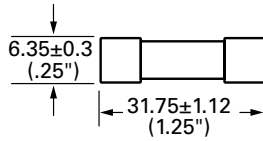

Part Numbering System

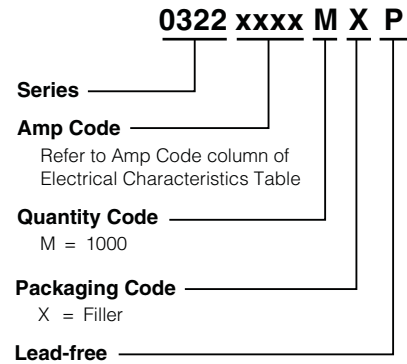

Packaging

Packaging Option	Packaging Specification	Quantity	Quantity & Packaging Code	Reel Size
322Series				
Bulk	N/A	1000	MX	N/A
Bulk	N/A	100	HX	N/A
332 Series				
Bulk	N/A	100	HX	N/A
Bulk	N/A	1000	MX	N/A