

Selection Guide.....	484
Miniature Switches & Pilot Devices.....	486
AP Series ø8-16mm	486
A8 Series ø8mm.....	490
ø16mm Switches & Pilot Devices.....	495
X6 E-Stops ø16mm.....	495
XA E-Stops ø16mm	499
LB Series ø16mm	506
A6 Series ø16mm.....	542
L6 Series ø16mm	545
ø22mm Switches & Pilot Devices.....	578
LBW Series ø22mm	578
UP-Series Pilot Lights	599
XW E-Stops ø22mm.....	601
AP22M Series ø22mm	607
CW Series ø22mm	610
HW Series ø22mm	632
TW Series ø22mm	694
FB Series Enclosures.....	735
ø30mm Switches & Pilot Devices.....	737
XN E-Stops ø30mm	737
TWND Series ø30mm	743
TWTD Series ø30mm.....	773
EC2B Series Control Stations	803
EU2B Series ø30mm	803
Cam Switches - CS Series	826
Mono-Lever Switches - ARN Switches	833

Switches & Pilot Devices











www.IDEC.com/switches



Switches & Pilot Devices

Selection Guide

Appearance	Product Series	Mounting Hole	Contact Rating	Contact Mounting	Function	Page
	AP	ø8mm, ø10mm, ø12mm, ø16mm	N/A	N/A	Pilot light	486
	A8	ø8mm	1A	Unibody	Pushbutton, Pilot Light	490
	X6	ø16mm	5A	Unibody	E-Stop	495
	XA		5A	Removable/Unibody	E-Stop	499
	A6		1A	Unibody	Pushbutton, Pilot Light, Selector Switch, Key Switch, Stop Switch	541
	LB		3A	Removable	Pushbutton, Pilot Light, Selector Switch, Key Switch, Lever Switch, Buzzer	506
	L6	ø22mm	5A	Removable	Pushbutton, Pilot Light, Selector Switch, Key Switch, Stop Switch, Buzzer	524
	LBW		5A	Removable	Pushbutton, Illuminated Pushbutton, Pilot Light, Selector Switch, Key Switch.	578
	UP		N/A	LED Removable	LED Pilot Light	599
	XW		5A	Removable	E-Stop	601
	AP22M	ø22mm	N/A	Unibody	Pilot Light	607
	CW		10A	Removable	Pushbutton, Pilot light, selector switch, key selector	610
	HW		10A	Removable	Pushbutton, Pilot Light, Selector Switch, Key Switch, E-Stop, MonoLever	632

Signaling Lights

Relays & Sockets

Timers

Contactors

Terminal Blocks

Circuit Breakers

Selection Guide con't

Appearance	Product Series	Mounting Hole	Contact Rating	Contact Mounting	Function	Page
	TW	ø22mm	10A	Removable	Pushbutton, Pilot Light, Selector Switch, Key Switch, Stop Switch	694
	FB		N/A	N/A	Enclosures	735
	XN		5A	Removable	E-Stop	737
	TWND		10A	Removable	Pushbutton, Pilot Light, Selector Switch, Key Switch, Stop Switch	743
	TWTD	ø30mm	10A	Removable	Pushbutton, Pilot Light, Selector Switch, Key Switch, Stop Switch	773
	CS		10A	Unibody	Cam Switch	826
	ARN		10A	Removable	MonoLever	833
	LW Flush	ø25mm, □ 25 x 25mm	5A	Removable	Pushbutton, Pilot Light, Selector Switch, Key Switch	www.IDEC.com/switches

Switches & Pilot Devices

Signaling Lights

Relays & Sockets

Timers

Contactors

Terminal Blocks

Circuit Breakers

AP Series — Miniature Pilot Lights

Key features:

- Long service life, low maintenance
- Space saving miniature style
- Dome or flat lens models
- Built-in current-limiting resistor
- Five illumination colors: red, green, amber, yellow, and white
- Transformer (120V AC and 240V AC) and DC-DC Converter (110V DC) options on 12mm and 16mm units



*AP8/AP1 series only.

Specifications

Lamp	Built-in LED with current limiting resistor
Operational Voltage	5, 6, 12, 24VDC (full voltage), 110/120, 220/240VAC, (with transformer) 110VDC (with converter)
Current Ratings	AP8: 5V DC/9mA, 12V DC/9mA, 24V DC/9mA, 12V AC/15mA, 24V AC/15mA AP1: 5V DC/9mA, 12V DC/9mA, 24V DC/9mA, 12V AC/15mA, 24V AC/15mA AP2: 6V DC/33mA, 12V DC/22mA, 24V DC/11mA AP6: 6V DC/33mA, 12V DC/22mA, 24V DC/11mA
Operating Temp.	-20°C to +55°C
Operating Humidity	45 to 85% RH
Insul. Resistance	100MΩ min. (500V DC megger) Between live and dead parts
Rev. Withstand Voltage	AP2/AP6: 100V AP1/AP8: 200V
Solder Terminal	Soldering 260°C maximum (5 sec.)
Degree of Protection	AP8: IP40 (dustproof) Other Series: IP65 (oiltight)

Optional Adaptors/Converters

Model	Transformer	DC-DC Converter
Applicable Units	AP2 & AP6 (with 6V LED only)	
Operating Voltage	110/120VAC 50/60 Hz 220/240VAC 50/60 Hz	110V DC (90 to 140V DC)
Power Consumption	1.6 VA maximum	1W maximum
Insulation Voltage	250 V AC	140V DC
Insulation Resistance	10MΩ min. (500V DC megger) Between live and dead parts	
Dielectric Strength	2,000V AC, 1 minute Between live/dead parts 2,000V AC, 1 minute Between terminals	2,000V AC, 1 minute Between live/dead parts 1,500V AC, 1 minute Between terminals

Available as one piece only (replacement LEDs are not available).

Miniature Pilot Lights

AP Miniature Pilot Lights - ø8 & ø10mm

Style	Lens Style	Operating Voltage	Part Numbers
AP8 Series - ø8mm	Dome	5V DC +/- 5% 12V AC/DC +/- 10% 24V AC/DC +/- 10%	AP8M255-Ⓞ AP8M211-Ⓞ AP8M222-Ⓞ
	Flat	5V DC +/- 5% 12V AC/DC +/- 10% 24V AC/DC +/- 10%	AP8M155-Ⓞ AP8M111-Ⓞ AP8M122-Ⓞ
AP1 Series - ø10mm	Dome	5V DC +/- 5% 12V AC/DC +/- 10% 24V AC/DC +/- 10%	AP1M255-Ⓞ AP1M211-Ⓞ AP1M222-Ⓞ
	Flat	5V DC +/- 5% 12V AC/DC +/- 10% 24V AC/DC +/- 10%	AP1M155-Ⓞ AP1M111-Ⓞ AP1M122-Ⓞ

Ⓞ Color Codes

Color	Code
Amber	A
Green	G
Red	R
Blue	S*
Warm White	W
Cool White	PW
Yellow	Y

* Available in only the AP8 and AP1 series.

- 1. In place of Ⓞ, specify the color code.
- 2. For dimensions, see page 489.
- 3. For accessories, see page 488.

AP Miniature Pilot Lights - ø12 & ø16mm

Style	Lens Style	Operating Voltage	Part Numbers
AP2 Series - ø12mm	Dome	6V DC +/- 5% 12V DC +/- 10% 24V DC +/- 10%	AP2M266-Ⓞ AP2M211-Ⓞ AP2M222-Ⓞ
	Flat	6V DC +/- 5% 12V DC +/- 10% 24V DC +/- 10%	AP2M166-Ⓞ AP2M111-Ⓞ AP2M122-Ⓞ
AP6 Series - ø16mm	Dome	6V DC +/- 5% 12V DC +/- 10% 24V DC +/- 10%	AP6M266-Ⓞ AP6M211-Ⓞ AP6M222-Ⓞ
	Flat	6V DC +/- 5% 12V DC +/- 10% 24V DC +/- 10%	AP6M166-Ⓞ AP6M111-Ⓞ AP6M122-Ⓞ

Ⓞ Color Codes

Color	Code
Amber	A
Green	G
Red	R
Warm White	W
Yellow	Y

- 1. In place of Ⓞ, specify the color code.
- 2. For dimensions, see page 489.
- 3. For accessories, see page 488.





Optional Transformers and DC-DC Converters (for AP2 and AP6 only)

Style	Voltage	Part Numbers		
		Used with AP2 Series	Used with AP6 Series	
	Transformer	110/120V AC 220/240V AC	AP2-0126D AP2-0246D	AP6-0126D AP6-0246D
	DC-DC Converter	110V DC (90-140V DC)	AP2-016DD	AP6-016DD

- 1. Optional Transformers and DC-DC converters snap onto the back of AP2 or AP6 pilot lights.
- 2. Transformers and DC-DC Converters step down to 6V.
- 3. For dimensions, see page 489.

Switches & Pilot Devices

Accessories – AP Series

Item	Appearance	Description	Used With	Part Number
Locking Ring Wrench		Made of metal. Used for tightening plastic locking ring during installation. Tightening torque should not exceed 3kgf-cm	Ø 16mm units	MT-001
			Ø 12mm units	MT-002
			Ø 10mm units	MT-003
			Ø 8mm units	MT-004
Mounting Hole Plug		Made of rubber. Fills unused mounting holes to provide IP65 protection	Unused 8mm panel cutouts	AL-B8
			Unused 10mm panel cutouts	AL-B1
			Unused 12mm panel cutouts	AL-B2
			Unused 16mm panel cutouts	AL-B6
Transformer Removal Tool		A Series Blank/Lens Removal Tool	AP2 and AP6 snap on transformer and DC-DC converter	MT-100
Replacement Lenses		Lenses (included with all units).	AP1M Flat	AP1M-L1-Ⓢ
			AP1M Dome	AP1M-L2-Ⓢ
			AP2M Flat	AP2M-L1-Ⓢ
			AP2M Dome	AP2M-L2-Ⓢ
			AP6M Flat	AP6M-L1-Ⓢ
			AP6M Dome	AP6M-L2-Ⓢ

Signaling Lights

Relays & Sockets

- 1. In place of Ⓢ, specify the Lens Color Code.
- 2. Internal LED is fixed and cannot be removed or replaced.

Ⓢ Lens Color Codes

Color	Code
Amber	A
Green	G
Red	R
Blue	S*
White	W
Yellow	Y

Timers

Contactors

*Blue available in AP8/AP1 series only.

Terminal Blocks

Circuit Breakers

Dimensions – AP Series

Pilot Lights (AP Series)

Style	AP8		AP1		AP2			AP6		
	Flat	Dome	Flat	Dome	Flat	Dome	w/ Adaptor or Converter	Flat	Dome	w/ Adaptor or Converter
Panel Cut-out	Ø 0.319" (+0.0118, -0) 8.1mm (+0.3, -0)		Ø 0.398" (+0.0118, -0) 10.1mm (+0.3, -0)		Ø 0.480" (+0.0118, -0) 12.2mm (+0.3, -0)			Ø 0.638" (+0.0118, -0) 16.2mm (+0.3, -0)		
Outside Dimension	Ø 0.386" (9.8mm)		Ø 0.472" (12mm)		Ø 0.551" (14mm)	□ 0.709" (18mm)	□ 0.709" (18mm)	Ø 0.709" (18mm)	Ø 0.709" (18mm)	□ 0.709" (18mm)

AP6

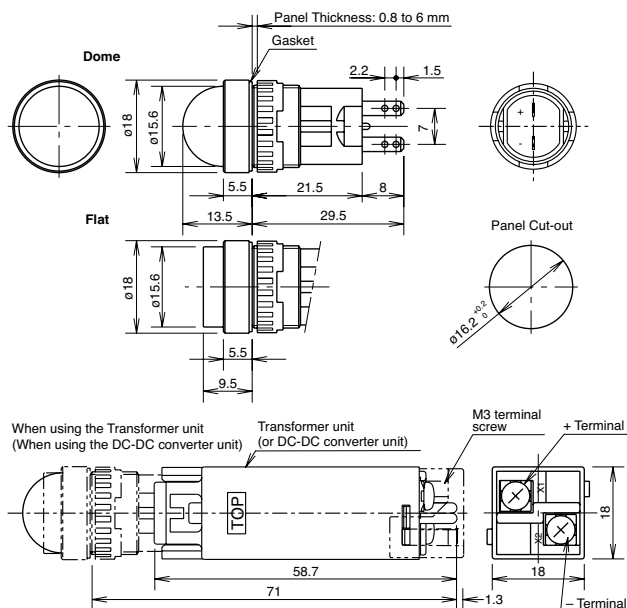

AP2

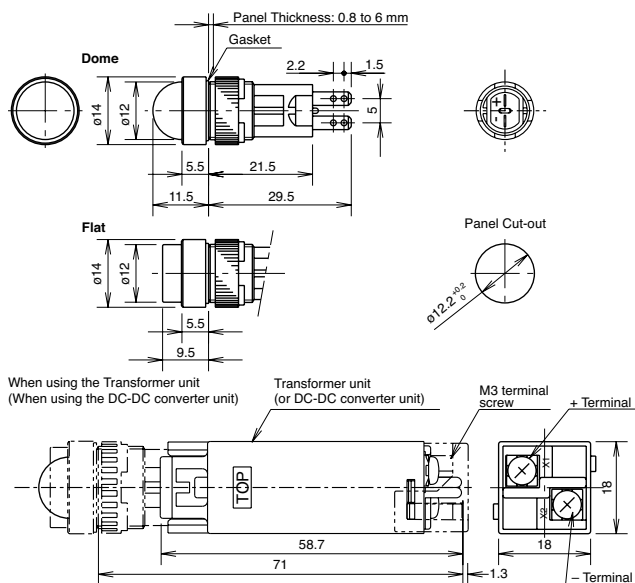

AP1

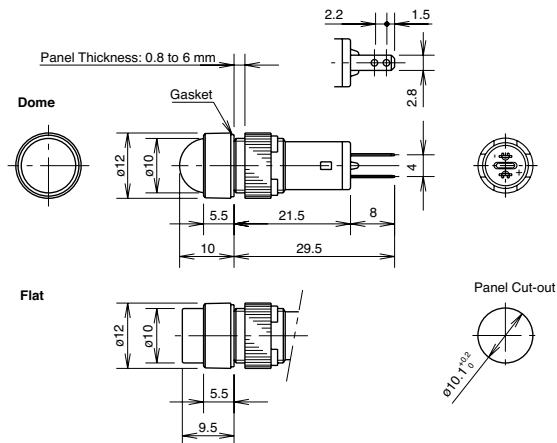

AP8

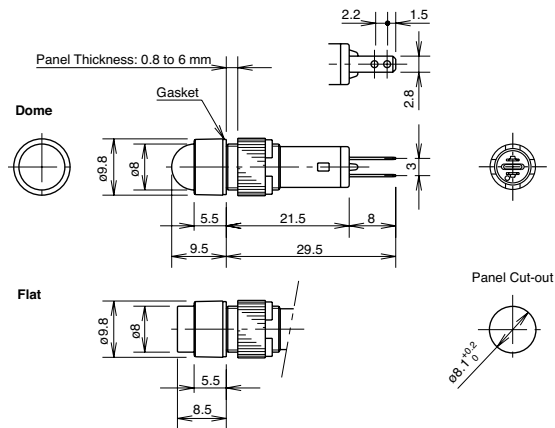

Switches & Pilot Devices

Signaling Lights

Relays & Sockets

Timers

Contactors

Terminal Blocks

Circuit Breakers

A8 Series — Miniature Switches and Pilot Devices: 8mm

Key features:

- 21/64" (8mm) round mounting hole
- Compact Design Saves Space
- Bright and Vivid Illumination
- Choice of Shapes and Functions
- Gold Clad Silver Contacts for reliable low level switching
- Snap action contacts
- IP40 (Dustproof) Construction



Specifications

LED Lamp Life	50,000 hours approximately (reduced to half of original intensity)
Contact Configuration	SPDT
Maximum Voltage	250V AC/DC
Thermal Current	3A
Contact Material	Gold-clad Silver
Terminal Style	Solder Tab Terminal
Operating Temperature	-25° to +55°C (no freezing)
Operating Humidity	45 to 85% RH
Contact Resistance	50mΩ maximum (initial value)
Insulation Resistance	100MΩ minimum (500V DC megger)
Vibration Resistance	5 to 55Hz, 0.75mm amplitude
Shock Resistance	Damage limits: 500m/sec ² (approx. 50G) Operating extremes: 200m/sec ² (approx. 20G)
Electrical Life	100,000 operations minimum
Mechanical Life	Maintained: 100,000 (1200 operations/hour) Momentary: 200,000 minimum
Degree of Protection	IP40 Enclosed/Dustproof
Soldering Temperature	20W/5 seconds or 260°C/3 seconds
Dielectric Strength	Switch Unit: 2,000V AC, 1 min. between live/dead part and terminals of different poles; 1,000V AC, 1 minute between terminals of the same pole; 1,500V AC, 1 minute between contact and lamp terminals. Illumination Unit: 2,000V AC, 1 min. between live part/ground

Contact Ratings

Operating Voltage		24V	120V	240V
AC 50/60Hz	Resistive	—	1.0A	0.5A
	Inductive	—	0.7A	0.5A
DC	Resistive	1.0A	0.2A	—
	Inductive	0.7A	0.1A	—

1. AC Inductive Load, PF = 0.6 – 0.7; DC Inductive Load, L/R = 7.
2. Minimum applicable load (reference value) is 5V AC/DC 3mA (applicable range is subject to the operating conditions and load).

Switches & Pilot Devices

Signaling Lights

Relays & Sockets

Timers

Contactors

Terminal Blocks

Circuit Breakers

AB8 Non-Illuminated Pushbuttons (Assembled)

Non-Illuminated Pushbuttons

Style	Contact	Part Numbers	
		Momentary	Maintained
Round 	SPDT	AB8M-M1-⓪	AB8M-A1-⓪
Square 	SPDT	AB8Q-M1-⓪	AB8Q-A1-⓪
Rectangular 	SPDT	AB8H-M1-⓪	AB8H-A1-⓪

⓪ **Button Color Codes**

Color	Code
Black	B
Green	G
Red	R
Blue	S
White	W
Yellow	Y

- 1. In place of ⓪, specify button color code from the table below.
- 2. For accessories, see page 493.
- 3. For dimensions, see page 494.

AL8 Illuminated Pushbuttons & Pilot Lights (Assembled)

Illuminated Pushbuttons

Style	Contact	Part Numbers		Pilot Light Part Number
		Momentary	Maintained	
Round 	SPDT	AL8M-M11-Ⓞ	AL8M-A11-Ⓞ	AL8M-P1-Ⓞ
Square 	SPDT	AL8Q-M11-Ⓞ	AL8Q-A11-Ⓞ	AL8Q-P1-Ⓞ
Rectangular 	SPDT	AL8H-M11-Ⓞ	AL8H-A11-Ⓞ	AL8H-P1-Ⓞ

Ⓞ LED/Lens Color Codes

Color	Code
Amber	A
Green	G
Red	R
White	W
Yellow	Y

- 1. In place of Ⓞ, specify lens color code from table on the right.
- 2. A replaceable LED lamp is included with the operator.
- 3. Because the LED lamp does not contain an internal current limiting resistor, an external resistor must be added. For recommended values, see table below.
- 4. For accessories, see page 493.
- 5. For dimensions, see page 494.

Replacement LEDs

Lens Color	LED Lamp	Part Number
Amber	Amber	LAD-SA
Green	Green	LAD-SG
Red	Red	LAD-SR
White	Yellow*	LAD-SY
Yellow	Yellow	LAD-SY

* White units use a white lens and a yellow LED.

LED Voltage and Recommended Current Limiting Resistor









Voltage	External Resistor
5V DC	150Ω, 1/2W
6V DC	200Ω, 1/2W
12V DC	510Ω, 1W
24V DC	1.1kΩ, 1W

LED Lamp Ratings: LED Specifications

LED Lamp	Forward Current I _f	Forward Voltage (Nominal) V _f	Reverse Voltage V _r	Operating Voltage & External Current Limiting Resistor (Recommended Value)
Amber	20mA	2.2V	4V	5V DC: 150Ω, 1/2W 6V DC: 200Ω, 1/2W 12V DC: 510Ω, 1W 24V DC: 1.1kΩ, 1W
Green	20mA	2.1V	4V	
Red	20mA	1.7V	4V	
Yellow	20mA	2.2V	4V	

When LED lamps are used at voltages other than those stated above, external resistor value, R, is determined by the following formula: $R = (Operating\ Voltage - V_f) / I_f$

Accessories

Item	Description	Used With	Part Number
 <p>Locking Ring Wrench</p>	Made of metal. Used for tightening plastic locking ring during installation. Tightening torque should not exceed 3kgf-cm	All units	MT-004
 <p>Lens Removal Tool</p>	Made of metal. Used for removing lens or button from the housing	Illuminated pushbuttons and pilot lights	MT-101
 <p>Lamp Holder Tool</p>	Made of rubber. Used for removing and replacing LED lamps in illuminated units	Illuminated pushbuttons and pilot lights	OR-66
 <p>Switch Guard</p>	Used to avoid operating the pushbutton inadvertently. Cover flips open 90°. Provides IP40 protection	Round & square units	AL-K8
		Rectangular units	AL-KH8
 <p>Terminal Cover</p>	Made of translucent nylon. Fits over and shields the terminals	All units	AL-V8
 <p>Adaptor Socket</p> <p>AL-C8 AL-C8V shown attached</p>	Plug-on adaptor with solder terminals, allows easy control unit replacement. Plug-on adaptor with PCB terminals, allows easy control unit replacement.	All units	AL-C8
			AL-C8V
 <p>Mounting Hole Plug</p>	Made of rubber. Fills unused mounting holes to provide IP65 protection	Extra panel cutouts	AL-B8
 <p>Replacements LEDs</p>	LED lamp is included in every illuminated control unit. Replacement lamp is ordered separately. External current limiting resistor required.	Illuminated units and pilot lights	LAD-SR (red)
			LAD-SG (green)
			LAD-SA (amber)
			LAD-SY (yellow)
 <p>Replacement Lenses</p>		Illuminated pushbuttons and pilot lights	Round AL8M-LK1-②
			Square AL8Q-LK1-②
			Rectangular AL8H-LK1-②
 <p>Replacement Buttons</p>		Non-Illuminated buttons	Round AB8M-BK1-①
			Square AB8Q-BK1-①
			Rectangular AB8H-BK1-①

- 1. In place of ①, specify Button Color Code from the table.
- 2. In place of ②, specify Lens Color Code from table.

① Button Color Codes

Color	Code
Black	B
Green	G
Red	R
Blue	S
White	W
Yellow	Y

② LED/Lens Color Codes

Color	Code
Amber	A
Green	G
Red	R
White	W
Yellow	Y

Dimensions

AΔ8

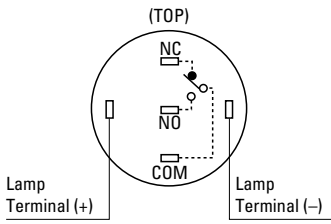
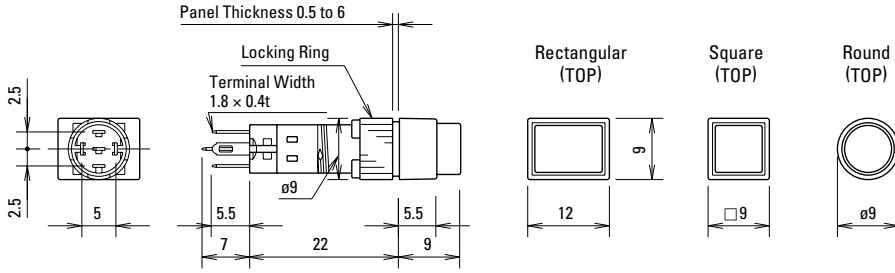

Rectangular Square Round

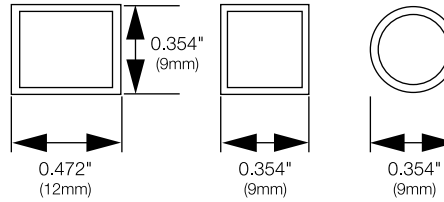

Panel Cut-Out (not drawn to scale)
 Rectangular

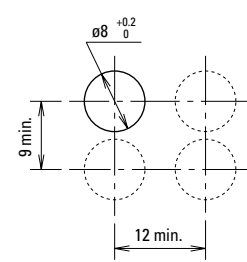

Round/Square

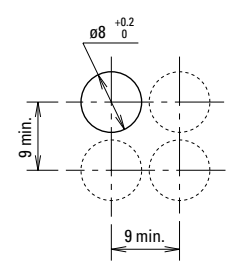

Switch Guard, Ø 21/64" (8mm)

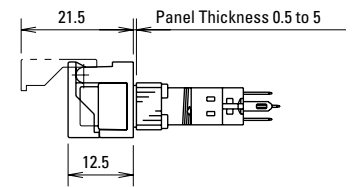

Terminal Sockets

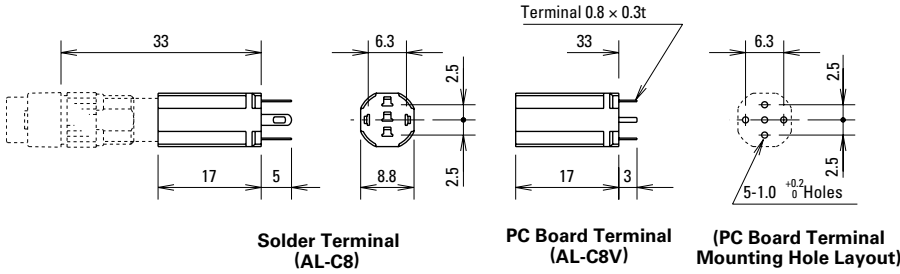

Terminal Arrangement (TOP)

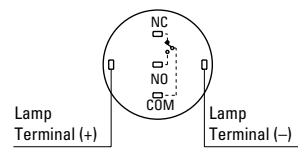

For Round/Square Units (AL-K8)

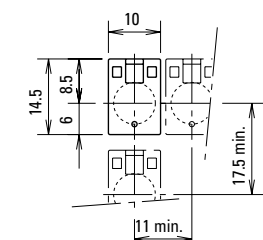

Terminal Cover

AL-V8, Ø 21/64" (8mm)

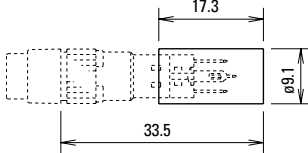

For Rectangular Units (AL-KH8)

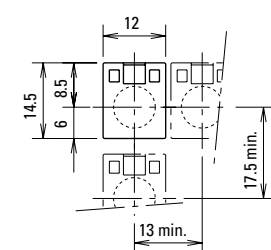

16mm X6 E-Stops

Key features:

- Two button sizes—ø30mm and ø40mm
- Two button colors—red for emergency stop and yellow for stop switch
- Two ways of resetting —pulling and turning
- Solder/tab terminal #110 makes for easy connections
- UL, c-UL recognized, EN compliant
- Safety lock mechanism (IEC 60947-5-5; 6.2)
- Direct opening action (IEC 60947-5-5; 5.2, IEC 60947-5-1, Annex K)



UL File No. E68961



CCC No. 2010010305411586

Specifications

Applicable Standards	IEC 60947-5-1, EN 60947-5-1 IEC 60947-5-5 (Note), EN 60947-5-5 (Note) JIS C8201-5-1, JIS C8201-5-5, UL508 CSA C22.2 No.14, GB14048.5
Operating Temperature	-25 to +60°C (no freezing)
Operating Humidity	45 to 85% RH (no condensation)
Storage Temperature	-45 to +80°C (no freezing)
Operating Force	Push to lock: 10.5N, Pull to reset: 8.8N, Turn to reset: 0.17 N·m
Minimum Force Required for Direct Opening Action	40N
Minimum Operator Stroke Required for Direct Opening Action	4.5mm
Maximum Operator Stroke	4.5mm
Contact Resistance	50mΩ maximum (initial value)
Insulation Resistance	100MΩ minimum (500V DC megger)
Overvoltage Category	II
Impulse Withstand Voltage	2.5kV
Pollution Degree	3
Operation Frequency	900 operations/hour
Shock Resistance	Operation extremes: 150 m/s ² , Damage limits: 1000 m/s ²
Vibration Resistance	Operation extremes: 10 to 500 Hz amplitude 0.35 mm, acceleration 50 m/s ² Damage limits: 10 to 500 Hz, amplitude 0.35 mm, acceleration 50 m/s ²
Mechanical Life	100,000 operations minimum
Electrical Life	100,000 operations minimum
Degree of Protection	IP65 (IEC 60529)
Short-circuit Protection	250V/10A fuse (Type aM IEC 60269-1/IEC 60269-2)
Conditional Short-circuit Current	1000A
Terminal Style	Solder/tab terminal #110
Recommended Tightening Torque for Locking Ring	0.88N·m
Applicable Wire Size	1.25mm ² maximum (AWG16 maximum)
Terminal Soldering Condition	310 to 350°C, within 3 seconds
Weight (approx.)	ø30mm button: 13g, ø40mm button: 16g

Contact Ratings

Rated Insulation Voltage (Ui)		250V				
Rated Thermal Current (Ith)		5A				
Rated Operating Voltage (Ue)		30V	125V	250V		
Rated Operating Current (Note)	Main Contacts	AC 50/60 Hz	Resistive Load (AC-12)	-	5A	3A
			Inductive Load (AC-15)	-	1.5A	0.75A
	DC	Resistive Load (DC-12)	2A	0.4A	0.2A	
		Inductive Load (DC-13)	1A	0.22A	0.1A	





- Minimum applicable load: 5V AC/DC, 1mA (reference value) (May vary depending on the operating conditions and load)
- Operational current represents the classification by making and breaking currents (IEC 60947-5-1)
- TÜV rating: AC-15 0.75A/250V, DC-13 1A/30V
UL rating: Standard Duty AC 0.75A/250V
Standard Duty DC 1A/30V





Except for stop switch (yellow button)

Part Numbers

Pushlock Pull/Turn Reset Switch (Unmarked)

Shape	Main Contact (NC)	Part Number
		Solder/tab Terminal #110
 ø30mm Mushroom	1NC	AB6E-3BV01PTRH
	2NC	AB6E-3BV02PTRH
 ø40mm Mushroom	1NC	AB6E-4BV01PTRH
	2NC	AB6E-4BV02PTRH

Pushlock Pull/Turn Reset Switch (Marked with Arrow)



Shape	Main Contact (NC)	Part Number
		Solder/tab Terminal #110
 ø30mm Mushroom	1NC	AB6E-3BV01PTRM
	2NC	AB6E-3BV02PTRM
 ø40mm Mushroom	1NC	AB6E-4BV01PTRM
	2NC	AB6E-4BV02PTRM

Yellow Button, Pushlock Pull/Turn Reset Switch (Unmarked)

Shape	Operator	Main Contact (NC)	Part Number
			Solder/tab Terminal #110
 ø30mm Mushroom	ø30mm button	1NC	AB6E-3BV01PTY
		2NC	AB6E-3BV02PTY
	ø40mm button	1NC	AB6E-4BV01PTY
		2NC	AB6E-4BV02PTY

- 1. Pushlock pull/turn reset switches are locked when pressed, and reset when pulled or turned clockwise.
- 2. Do not use the stop switch as an emergency stop switch.

Accessories

Shape	Material	Part Number	Remarks
 Locking Ring Wrench	Metal (nickel-plated brass)	MT-001	Used to tighten the locking ring when installing the X6 switch onto a panel. Recommended tightening torque: 0.88 N·m maximum
 Locking Ring	Plastic	XA9Z-LNPN10	Black
 SEMI S2 Compliant Switch Guard	Polyamide (PA6)	XA9Z-KG1	IP65 degree of protection Color: yellow (Munsell 2.5Y8/10 or equivalent) Cannot be used with nameplate.

Part Number Key

AB6E - 3 BV 01 PT RH

Mushroom Size — Contact Configuration — Color/Marking

3: ø29mm 01: 1NC RH: Red (unmarked)
 4: ø40mm 02: 2NC RM: Red (marked with arrow)
 Y: Yellow (unmarked)

Nameplates

Use With	Description	Legend	Part Number	Material	Background Color	Legend Color
E-Stops	For ø30mm Button	Blank	HAAV-0	Polyamide	Yellow	Black
		EMERGENCY STOP	HAAV-27			
	For ø40mm Button	Blank	HAAV4-0			
		EMERGENCY STOP	HAAV4-27			
Stop Switch	For ø30mm Button	Blank	HAAV-0-W	White (Munsell N9.5)		
	For ø40mm Button		HAAV4-0-W			

- Cannot be used with switch guard.

Dimensions (mm)

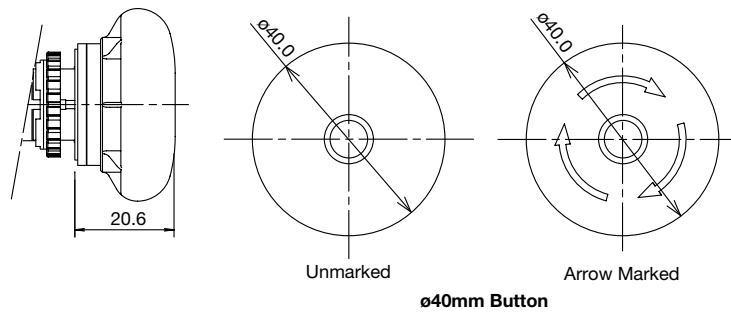
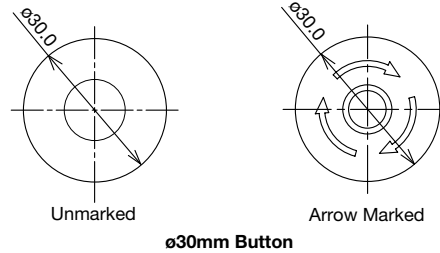
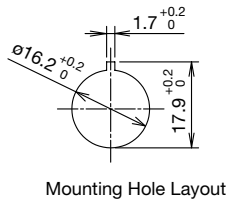
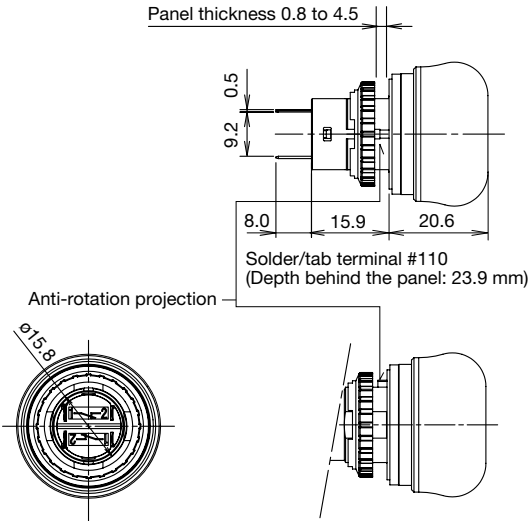

Nameplate for ø30mm Button HAAV-*

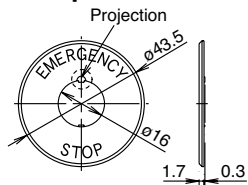

Nameplate for ø40mm Button HAAV4-*

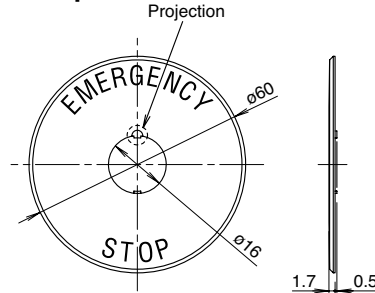

Switch Guard XA9Z-KG1

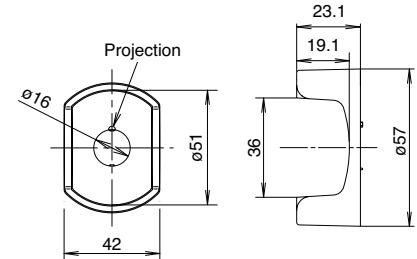

Mounting Hole Layout

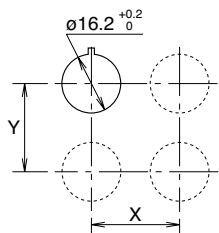

The values shown on the left are the minimum dimensions for mounting with other ø16 mm pushbuttons. For other control units of different sizes and styles, determine the values according to dimensions, operation, and wiring.

	X	Y
ø30 mm Button	40 mm min.	40mm min.
ø40 mm Button	50 mm min.	50mm min.

Terminal Arrangement (Bottom View)

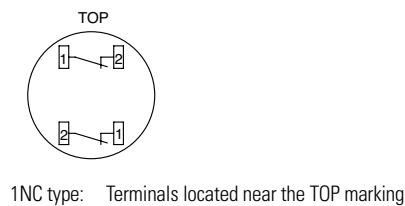

Safety Precautions

- Turn off power to the X6 series units before installation, removal, wiring, maintenance, and inspection. Failure to turn power off may cause electrical shocks or fire hazard.
- For wiring, use wires of proper size to meet the voltage and current requirements and solder properly. Improper soldering may cause overheating and create fire hazards.

Instructions

Panel Mounting

Remove the locking ring from the operator and check that the rubber gasket is in place. Insert the operator from panel front into the panel hole. Face the side with the projection upward, and tighten the locking ring using the locking ring wrench MT-001.

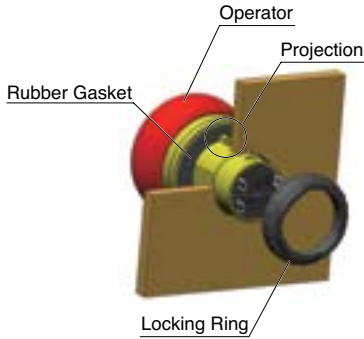

Notes for Panel Mounting

Using the locking ring wrench MT-001, tighten the locking ring to a torque of 0.88 N·m. Do not use pliers. Do not apply excessive force, otherwise the locking ring will become damaged.

Contact Bounce

When the button is reset by pulling or turning, the NC contacts will bounce. When designing a control circuit, take the contact bounce time into consideration (reference value: 20ms).

Do not apply any external shock to the emergency stop switches, otherwise the contact will bounce.

Handling

Do not expose the switch to excessive shock and vibrations, otherwise the switch may be deformed or damaged, causing malfunction or operation failure.

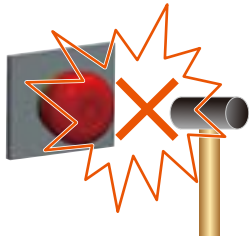

Wiring

1. Applicable wire size is 1.25mm² (16 AWG) maximum.
2. Solder the terminals using a soldering iron at 310 to 350°C for 3 seconds maximum. Do not use flow or dip soldering. SnAgCu type lead-free solder is recommended. Make sure that the soldering iron touches the terminals only, not any plastic parts. Do not apply external force (bending the terminals or applying tensile force on the wires).
3. Use a non-corrosive rosin flux. To prevent the flux from entering the switch while soldering, angle the terminals downward.

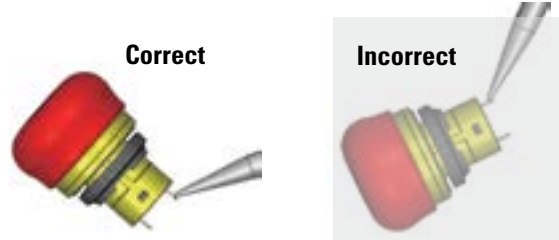

4. Because the terminal spacing is narrow, use protective tubes or heat shrinkable tubes to avoid burning the wire sheath or causing a short circuit.
5. Apply force on the terminals in the vertical direction to the panel only, otherwise the terminals will be damaged.
6. When using tab connectors, specify quick connect #110 and 0.5mm tab thickness.

16mm XA E-Stops

Key features:

- Two button sizes: ø29 and ø40mm
- Lead-free, RoHS compliant, (EU directive 2002/95/EC)
- Depth behind the panel:
Standard - only 27.9mm for 1 to 4 contacts
Unibody - only 23.9mm for 1NC or 2NC
- IDEC's original "Safe break action" ensures that the NC contacts open when the contact block is detached from the operator.
- Push-to-lock, Pull or Turn-to-reset operator
- Direct opening action mechanism (IEC60947-5-5, 5.2, IEC60947-5-1, Annex K)
- Safety lock mechanism (IEC60947-5-5, 6.2)
- Degree of protection:
Standard - IP65 (IEC60529)
Unibody - IP65 and IP40 (IEC 60529)
- UL, c-UL recognized. EN compliant
- UL NISD2 category emergency stop button (File# E305148)



CCC No. 2005010305150899

Specifications



Model	Standard	Unibody
Applicable Standards	IEC60947-5-1, EN60947-5-1, IEC60947-5-5, EN60947-5-5, UL508, UL991, CSA C22.2 No. 14	UL508, CSA C22.2 No.14, IEC 60947-5-1, EN 60947-5-1 IEC 60947-5-5 ^{Note} , EN 60947-5-5 ^{Note} , JIS C8201-5-1
Operating Temperature	Non-illuminated: -25 to +60°C (no freezing), Illuminated: -25 to +55°C (no freezing)	-25 to +60°C (no freezing)
Operating Humidity	45 to 85% RH (no condensation)	
Storage Temperature	-45 to +80°C	
Operating Force	Push-to-lock: 10.5N Pull-to-reset: 10N Turn-to-reset: 0.16N·m	
Minimum Force Required for Direct Opening Action	60N	40N
Min Operator Stroke Required for Direct Opening Action	4mm	
Maximum Operator Stroke	4.5mm	
Contact Resistance	50mΩ maximum (initial value)	
Contact Material	Gold plated silver	
Insulation Resistance	100MΩ minimum (500V DC megger)	
Impulse Withstand Voltage	2.5kV	
Pollution Degree	3 (inside LED unit: 2)	3
Operation Frequency	900 operations/hour	
Shock Resistance	Operating extremes: 150 m/s ² , Damage limits: 1000 m/s ²	
Vibration Resistance	Operating extremes: 10 to 500Hz, amplitude 0.35mm acceleration 50m/s ² , Damage limits: 10 to 500Hz, amplitude 0.35mm acceleration 50m/s ²	
Mechanical Life	250,000 operations minimum	
Electrical Life	100,000 operations minimum, (250,000 operations minimum @ 24V AC/DC, 100mA)	
Degree of Protection	IP65 (IEC60529)	IP65, IP40 (IEC 60529)
Terminal Style	Solder terminal, PC board terminal	Solder/tab #110 terminal
Recommended Tightening Torque for Locking Ring	0.88N·m	
Wire Size	16 AWG max	
Soldering Conditions	310 to 350°C, 3 seconds maximum	
Weight	ø29mm: 23g ø40mm: 28g	ø29mm mushroom: 14g ø40mm mushroom: 17g





Note: Except for stop switches (operator color: yellow and gray)

Part Numbers

Non-Illuminated XA E-Stop

Style	Termination	Monitor Contacts	Main Contacts	Part Number
 29mm Mushroom	PCB Terminal	1NO	1NC	XA1E-BV311V-R
		-	2NC	XA1E-BV302V-R
		1NO	3NC	XA1E-BV313V-R
		-	4NC	XA1E-BV304V-R
	Solder Terminal	1NO	1NC	XA1E-BV311-R
		-	2NC	XA1E-BV302-R
		1NO	3NC	XA1E-BV313-R
		-	4NC	XA1E-BV304-R
 40mm Mushroom	PCB Terminal	1NO	1NC	XA1E-BV411V-R
		-	2NC	XA1E-BV402V-R
		1NO	3NC	XA1E-BV413V-R
		-	4NC	XA1E-BV404V-R
	Solder Terminal	1NO	1NC	XA1E-BV411-R
		-	2NC	XA1E-BV402-R
		1NO	3NC	XA1E-BV413-R
		-	4NC	XA1E-BV404-R

Illuminated XA E-Stop

Style	Termination	Monitor Contacts	Main Contacts	Part Number
 29mm Mushroom	PCB Terminal	1NO	1NC	XA1E-LV311Q4V-R
		-	2NC	XA1E-LV302Q4V-R
		1NO	3NC	XA1E-LV313Q4V-R
		-	4NC	XA1E-LV304Q4V-R
	Solder Terminal	1NO	1NC	XA1E-LV311Q4-R
		-	2NC	XA1E-LV302Q4-R
		1NO	3NC	XA1E-LV313Q4-R
		-	4NC	XA1E-LV304Q4-R
 40mm Mushroom	PCB Terminal	1NO	1NC	XA1E-LV411Q4V-R
		-	2NC	XA1E-LV402Q4V-R
		1NO	3NC	XA1E-LV413Q4V-R
		-	4NC	XA1E-LV404Q4V-R
	Solder Terminal	1NO	1NC	XA1E-LV411Q4-R
		-	2NC	XA1E-LV402Q4-R
		1NO	3NC	XA1E-LV413Q4-R
		-	4NC	XA1E-LV404Q4-R



All illuminated XA E-Stops come with a replaceable 24V AC/DC LED.

Part Number Key

XA1E - L V 3 11 Q4 V - R

Illumination
 B: Non-Illuminated
 L: Illuminated



Contact Configuration
 11: 1NO - 1NC
 02: 2NC
 13: 1NO - 3NC
 04: 4NC

Terminal
 Blank: solder tab
 V: PCB

Mushroom Size
 3: ø29mm
 4: ø40mm

Voltage Code
 Blank: Non-illuminated
 Q4: Illuminated 24V AC/DC

Unibody XA E-Stop

Style	Contact	Part Number	
		IP40 (black housing)	IP65 (yellow housing)
29mm Mushroom 	1NC	XA1E-BV3U01KT-R	XA1E-BV3U01T-R
	2NC	XA1E-BV3U02KT-R	XA1E-BV3U02T-R
40mm Mushroom 	1NC	XA1E-BV4U01KT-R	XA1E-BV4U01T-R
	2NC	XA1E-BV4U02KT-R	XA1E-BV4U02T-R

Unibody XA Stop Switch

Style	Operator Type	Contact	① Color Code	Part Number	
				IP40 (black housing)	IP65 (yellow housing)
	29mm Mushroom	1NC	Y: yellow N: gray	XA1E-BV3U01KT-①	XA1E-BV3U01T-①
		2NC		XA1E-BV3U02KT-①	XA1E-BV3U02T-①
	40mm Mushroom	1NC		XA1E-BV4U01KT-①	XA1E-BV4U01T-①
		2NC		XA1E-BV4U02KT-①	XA1E-BV4U02T-①

EMO XA E-Stop

Style	NC Main Contact	NO Monitor Contact	Part Number
40mm Mushroom 	1NC	-	XA1E-BV401-RH-EMO
	2NC	-	XA1E-BV402-RH-EMO
	3NC	-	XA1E-BV403-RH-EMO
	4NC	-	XA1E-BV404-RH-EMO
	1NC	1NO	XA1E-BV411-RH-EMO
	2NC	1NO	XA1E-BV412-RH-EMO
	3NC	1NO	XA1E-BV413-RH-EMO

Switches & Pilot Devices

Signaling Lights

Relays & Sockets

Timers

Contactors

Terminal Blocks

Circuit Breakers

Contact Ratings

Standard						
Rated Insulation Voltage (Ui)		300V (illuminated part: 60V)				
Rated Current (Ith)		5A				
Rated Operating Voltage (Ue)		30V	125V	250V		
Rated Operating Current	Main Contacts (NC)	AC 50/60Hz	Resistive Load (AC-12)	–	3A	3A
			Inductive Load (AC-15)	–	1.5A	1.5A
	DC		Resistive Load (DC-12)	2A	0.4A	0.2A
			Inductive Load (DC-13)	1A	0.22A	0.1A
Rated Operating Current	Monitor Contacts (NO)	AC 50/60Hz	Resistive Load (AC-12)	–	1.2A	0.6A
			Inductive Load (AC-14)	–	0.6A	0.3A
	DC		Resistive Load (DC-12)	2A	0.4A	0.2A
			Inductive Load (DC-13)	1A	0.22A	0.1A

Unibody						
Rated Insulation Voltage (Ui)		250V				
Thermal Current (Ith)		5A				
Rated Operating Voltage (Ue)		30V	125V	250V		
Rated Operating Current	AC 50/60Hz	Resistive Load (AC-12)	–	5A	3A	
		Inductive Load (AC-15)	–	3A	1.5A	
	DC	Resistive Load (DC-12)	2A	0.4A	0.2A	
		Inductive Load (DC-13)	1A	0.22A	0.1A	

 Minimum applicable load: 5V AC/DC, 1mA (reference value).
The rated operating currents are measured at resistive/inductive load types specified in IEC 60947-5-1.

Mounting Hole Layout

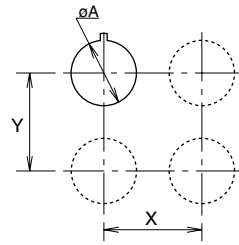

Measurements

Model	øA	X & Y
ø29mm	16.2 ^{+0.2}	40mm min
ø40mm	16.2 ^{+0.2}	50mm min

Panel Cutout

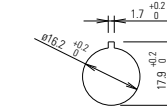

PC Board Layout - Bottom View

Non-Illuminated

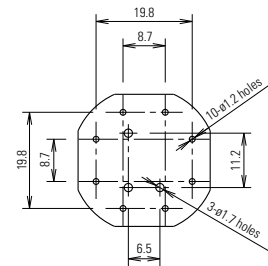

Illuminated

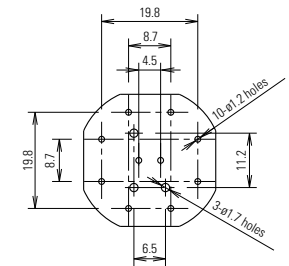

Illuminated Unit LED Ratings

Operating Voltage	Current
24V AC/DC ±10%	11mA

Depth Behind the Panel

Depth (mm)	Description
27.9 (Standard)	1 - 4 contacts, both illuminated and non-illuminated
23.9 (Unibody)	1NC or 2NC

Terminal Arrangements (Bottom View)

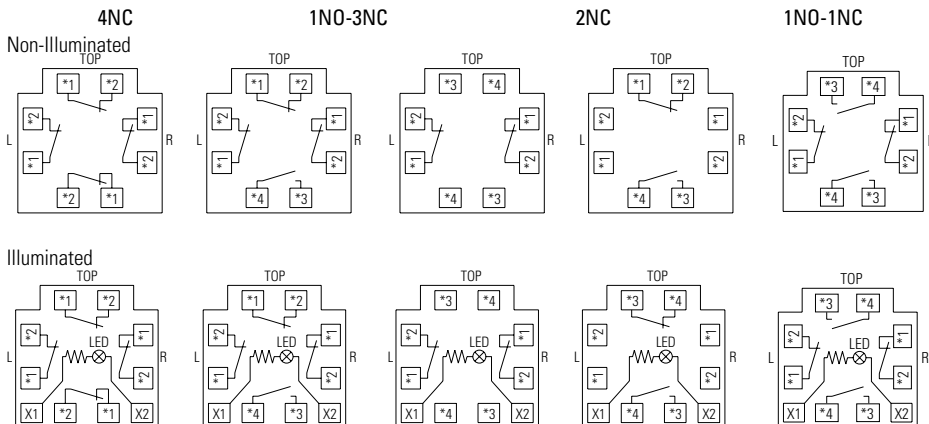

Dimensions (mm)

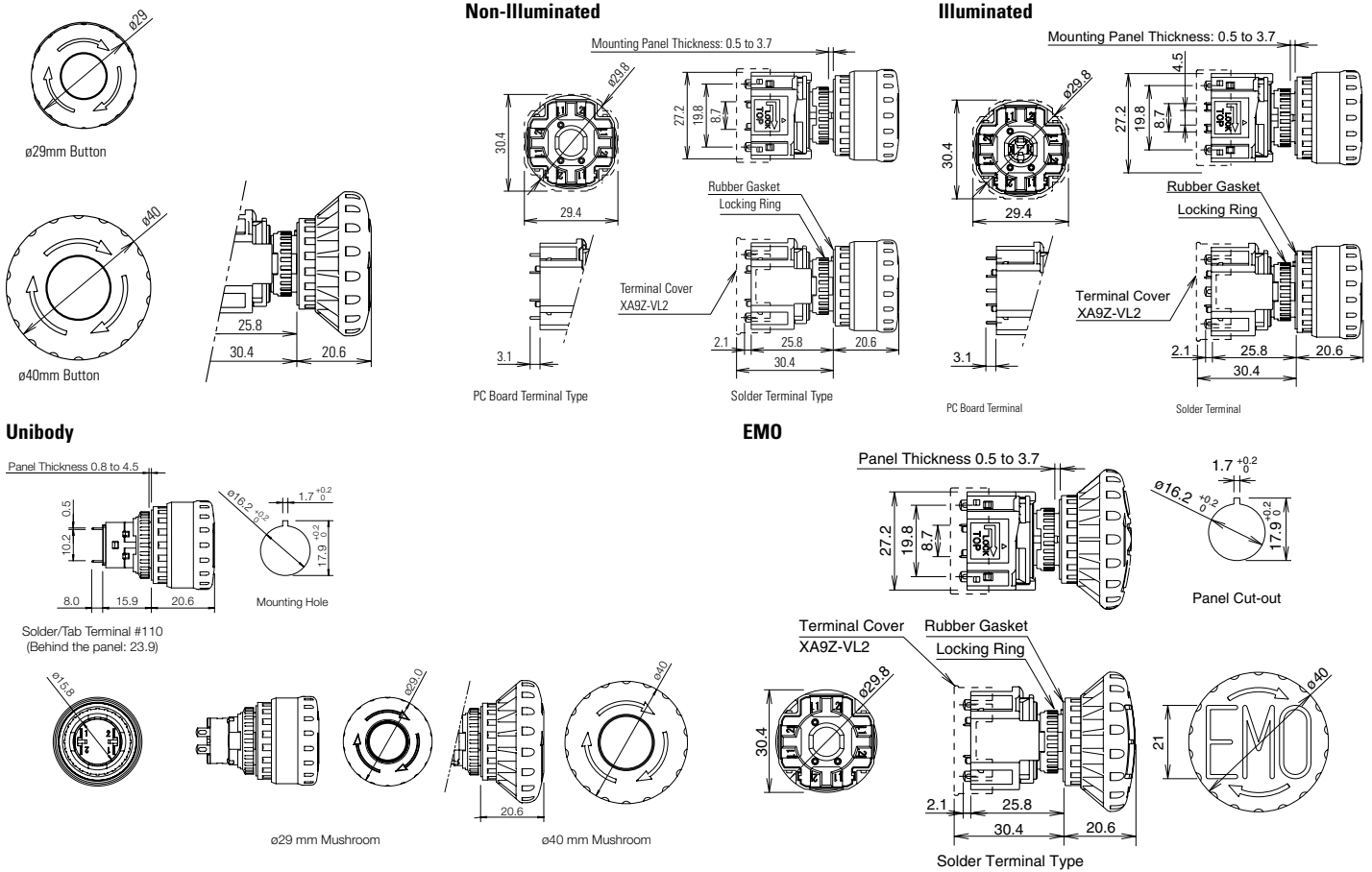

Accessories

Description	Part Numbers
Replacement LED Unit: Solder Terminal	XA9Z-LED2R
Replacement LED Unit: PCB Terminal	XA9Z-LED2VR
Terminal Cover for contact block (solder terminal only)	XA9Z-VL2

Accessories: Shroud

Appearance	Part Number	Applicable Standards
	XA9Z-KG1	SEMI S2 Compliant (Approved by TUV)

Accessories: Nameplates

Appearance	Legend	Part Number	Inner Ø	Outer Ø	Applicable Mushroom Size
	(blank)	HAAV-0	16mm	43mm	29mm
	"Emergency Stop"	HAAV-27	16mm	43mm	
	(blank)	HAAV4-0	16mm	60mm	40mm
	"Emergency Stop"	HAAV4-27	16mm	60mm	

Operating Instructions

Removing the Contact Block

First unlock the operator button. While pushing up the white bayonet ring, using a small screwdriver (width: 2.5 to 3 mm) if necessary, turn the contact block counterclockwise and pull out. **Do not exert excessive force when using a screwdriver, otherwise the bayonet ring may be damaged.**

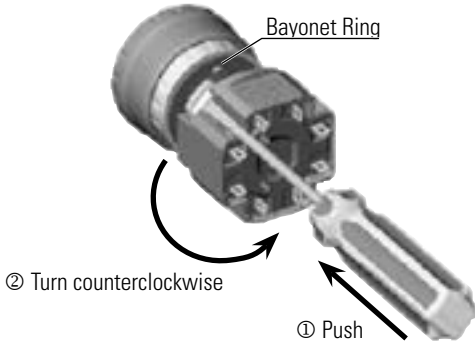

Notes for Removing the Contact Block

1. When the contact block is removed, the monitor contact (NO contact) is closed.
2. While removing the contact block, do not exert excessive force, otherwise the switch may be damaged.

Panel Mounting

Remove the locking ring from the operator and check that the rubber gasket is in place. Insert the operator from panel front into the panel hole. Face the side with the anti-rotation tab on the operator upward, and tighten the locking ring.

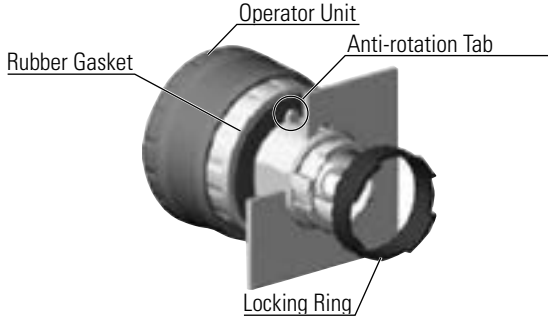

Notes for Panel Mounting

To mount XA emergency stop switches onto a panel, tighten the locking ring to a tightening torque of 0.88 N·m maximum using ring wrench MT-001. Do not use pliers. Do not exert excessive force, otherwise the locking ring may be damaged.

Installing the Contact Block

First turn the bayonet ring to the unlocked position.

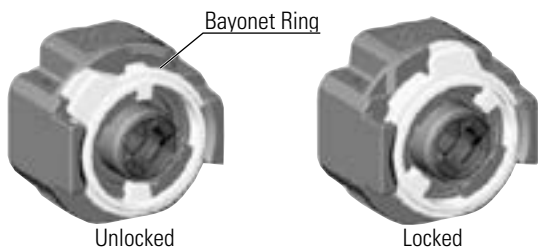

Align the small ▲ marking on the edge of the operator base with the TOP marking on the contact block. Press the contact block onto the operator and turn the contact block clockwise until the bayonet ring clicks.

Notes for Installing the Contact Block

Check that the contact block is securely installed on the operator. When the emergency stop switch is properly assembled, the bayonet ring is in place as shown below.

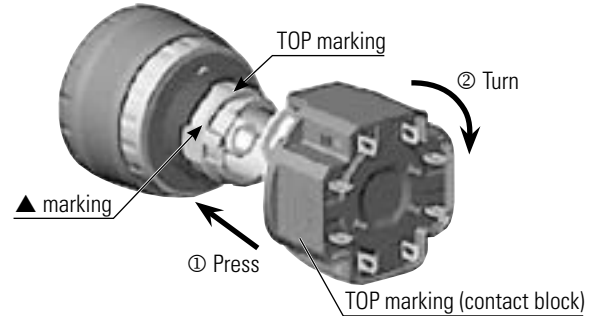

Removing the LED Unit

Pull out the LED unit while squeezing the latches on the LED unit using the LED unit removal tool (MT-101).

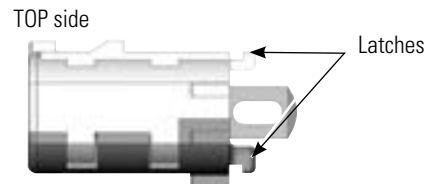
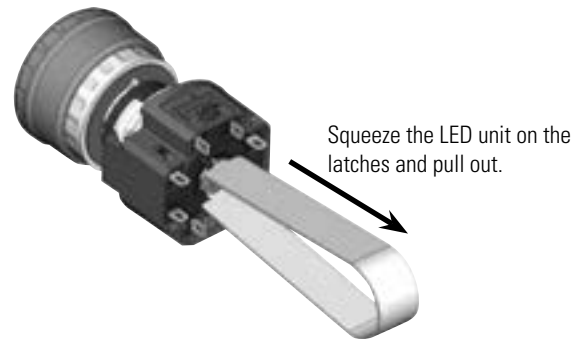

Installing the LED Unit

Align the top of the LED unit with the TOP marking on the contact block. Push the LED unit into the contact block.



Operating Instructions, continued

Wiring

1. The applicable wire size is 16 AWG maximum.
2. Solder the terminal at a temperature of 310 to 350°C within 3 seconds using a soldering iron. Sn-Ag-Cu solder is recommended. When soldering, do not touch the switch with the soldering iron. Also ensure that no tensile force is applied to the terminals. Do not bend the terminals or apply excessive force to the terminals.
3. Use a non-corrosive rosin flux.
4. Because the terminal spacing is narrow, use protective tubes or heat shrinkable tubes to avoid burning of wire coating or short circuit.

PC Board Terminal Type

1. When mounting a contact block on a PC board, provide sufficient rotating space for the PC board when installing and removing the contact block.
2. When mounting an XA emergency stop switch on a PC board, make sure that the operator is securely installed.

About PC Board and Circuit Design

1. Use PC boards made of glass epoxy copper-clad laminated sheets of 1.6 mm in thickness, with double-sided through holes.
2. PC boards and circuits must withstand rated voltage and current, including instantaneous current and voltage at switching.
3. The minimum applicable load is 5V AC/DC, 1 mA.
4. Within the 2.8* mm areas shown in the figure below, terminals touch the PC board, resulting in possible short circuit on the printed circuit. When designing a PC board pattern, take this possibility into consideration.

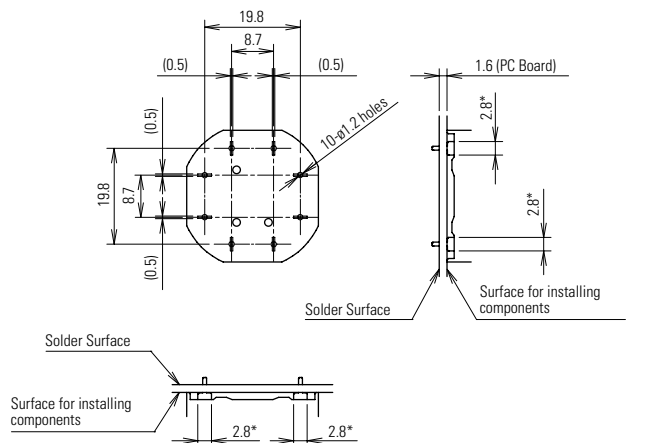

All dimensions in mm.

Installing Insulation Terminal Cover

To install the terminal cover (XA9Z-VL2), align the TOP marking on the terminal cover with TOP marking on the contact block, and press the terminal cover toward the contact block.

Note: For wiring, insert the wires into the holes in the terminal cover before soldering.

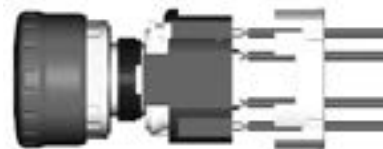

Contact Bounce

When the button is reset by pulling or turning, the NC main contacts will bounce. When pressing the button, the NO monitor contacts will bounce.

When designing a control circuit, take the contact bounce time into consideration (reference value: 20 ms).

Nameplate

When anti-rotation is not required, remove the projection from the nameplate using pliers.

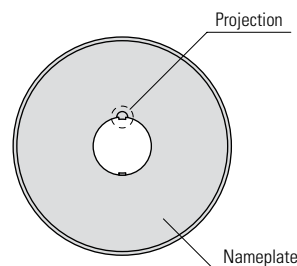

Handling

Do not expose the switch to excessive shock and vibration, otherwise the switch may be deformed or damaged, causing malfunction or operation failure.



Safety Precautions

- Turn off power to the XA series emergency stop switch before starting installation, removal, wiring, maintenance, and inspection of the relays. Failure to turn power off may cause electrical shock or fire hazard.
- Use the LED unit removal tool when replacing the LED unit to avoid burning your hands.
- Use wires of the proper size to meet the voltage and current requirements, and solder the wires correctly. If soldering is incomplete, the wire may heat during operation, causing a fire hazard.

LB Flush Mount & 16mm Miniature Switches & Pilot Lights

Flush bezel projects only 2mm from front of panel. Standard bezel has a depth of only 27.9mm! Removable contact blocks are ideal for single board mounting.

Key Features

- Pushbuttons, lever switches, selector switches, and key selector switches with up to 3PDT contacts.
- Key selectors with keys that are difficult to duplicate. Seven different key numbers to choose from.
- Pilot lights with flat or dome lenses.
- Buzzers with 80dB steady sound.
- Black or metallic flush bezels available.
- Bright and clear LED illuminated face.
- Choice of either gold-clad or silver contacts.
- Degree of protection: IP65 (from the front of the panel).



Applicable Standards	Mark	File No. or Organization
UL508		UL Recognition No.E55996
CSA 22.2 No.14		CSA File No. LR 21451
EN60947-5-1		TÜV Rheinland
		EU Low Voltage Directive
GB14048.5		

Specifications

Operating Temperature	-25 to +60°C (no freezing), Illuminated units: -25 to +55°C
Storage Temperature	-30 to +80°C (no freezing)
Operating Humidity	45 to 85% RH (no condensation)
Contact Resistance	50 mW maximum (initial value)
Insulation Resistance	100 MW minimum (500V DC megger)
Dielectric Strength	Switch Between live part and ground: 2,000V AC, 1 min. Between terminals of different poles: 2,000V AC, 1 min. Between terminals of the same poles: 1,000V AC, 1 min.
	Illumination Between live part and ground: 2,000V AC, 1 min.
Vibration Resistance	Operating extremes/Damage limits: 5 to 55 Hz, amplitude 0.5mm
Shock Resistance	Operating extremes: 100 m/s ² Damage limits: 1,000 m/s ²
Mechanical Life (minimum operations)	Momentary: 2,000,000 Maintained: 250,000 Selector switches: 250,000 Key selector switches: 250,000
Electrical Life (minimum operations)	Momentary: 50,000 / 100,000 ¹ Maintained: 50,000 / 100,000 ² Selector switches: 50,000 / 100,000 ² Key selector switches: 50,000 / 100,000 ²
Degree of Protection	IP65 (IEC 60529)
Terminal Style	Solder/tab terminal #110, PC board terminal
Bezel	Black plastic or metallic
Weight (approx.)	11g (lever switch)
	13g (pilot light, pushbutton)
	14g (illuminated pushbutton, pushbutton with guard, buzzer)
	15g (selector switch, illuminated pushbutton with guard) 27g (key selector switch)

1. Switching frequency 1,800 operations/h.
2. Switching frequency 1,200 operations/h.

Contact Ratings

Gold Contact (switch base color: blue)			
Rated Insulation Voltage	250V		
Rated Thermal Current	3A		
Rated Operating Voltage	30V DC	125V AC	
Rated Operating Current (resistive load)	0.1A	0.1A	
Contact Material	Gold-clad silver		

Minimum applicable load (reference value): 5V AC/DC, 1 mA

Silver Contact (switch base color: gray)					
Rated Insulation Voltage	250V				
Rated Operating Voltage	30V	125V	250V		
Rated Operating Current	AC 50/60Hz	Resistive load	—	5A	5A
		Inductive load	—	3A	1.5A
	DC	Resistive load	5A	1.1A	—
		Inductive load	2.5A	0.55A	—
	AC 50/60Hz	Resistive load	—	5A	3A
		Inductive load	—	3A	1.5A
DC	Resistive load	3A	0.6A	—	
	Inductive load	1A	0.22A	—	
Rated Thermal Current	5A				
Contact Material	Silver				

AC inductive load: PF=0.6 to 0.7 DC inductive load: L/R=7 ms max.

LED Ratings

Rated Voltage	5V DC	12V AC/DC	24V AC/DC
Voltage Range	5V DC±5%	12V AC/DC±10%	24V AC/DC ±10%
LED Part No.	LB9Z-LED5②	LB9Z-LED1②	LB9Z-LED2②

Rated Current	A, R: 22 mA G, PW, S: 16 mA
Voltage Rating	Marked on the side of the LED unit
LED Life (reference value)	Approx. 30,000 hours (until the brightness reduces to 50% of the initial value)

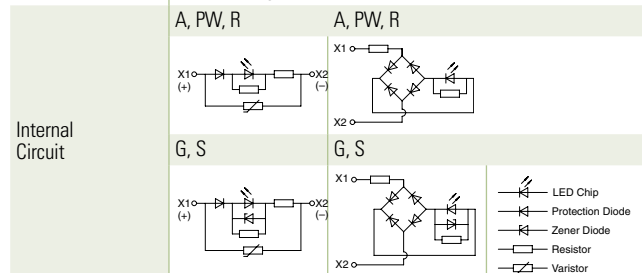

1. For ② (color code): A (amber), G (green), PW (white), R (red), S (blue)
2. Use the white LED for yellow illumination.
3. LED lamp contains a current-limiting resistor.

Illuminated Pushbuttons (Assembled)

Style	Operation	Operating Voltage	Contact	Standard Bezel		Flush Bezel		② Color Code
				Solder/Tab Terminal (silver contacts)	PC Board Terminal (gold contacts)	Solder/Tab Terminal (silver contacts)	PC Board Terminal (gold contacts)	
<p>Standard Bezel (black)</p>  <p>Flush Bezel (metallic or black)</p>  <p>Black Bezel with Guard</p> 	Momentary	5V DC	SPDT	LB⓪L-M1T51⓪	LB⓪L-M1T11V⓪	LB⓪⓪L-M1T51⓪	LB⓪⓪L-M1T11V⓪	Specify the color code in place of ② in the Part Number: A: amber G: green R: red S: blue PW: white Y: yellow
			DPDT	LB⓪L-M1T61⓪	LB⓪L-M1T21V⓪	LB⓪⓪L-M1T61⓪	LB⓪⓪L-M1T21V⓪	
		12V AC/DC	SPDT	LB⓪L-M1T53⓪	LB⓪L-M1T13V⓪	LB⓪⓪L-M1T53⓪	LB⓪⓪L-M1T13V⓪	
			DPDT	LB⓪L-M1T63⓪	LB⓪L-M1T23V⓪	LB⓪⓪L-M1T63⓪	LB⓪⓪L-M1T23V⓪	
		24V AC/DC	SPDT	LB⓪L-M1T54⓪	LB⓪L-M1T14V⓪	LB⓪⓪L-M1T54⓪	LB⓪⓪L-M1T14V⓪	
			DPDT	LB⓪L-M1T64⓪	LB⓪L-M1T24V⓪	LB⓪⓪L-M1T64⓪	LB⓪⓪L-M1T24V⓪	
	Maintained	5V DC	SPDT	LB⓪L-A1T51⓪	LB⓪L-A1T11V⓪	LB⓪⓪L-A1T51⓪	LB⓪⓪L-A1T11V⓪	
			DPDT	LB⓪L-A1T61⓪	LB⓪L-A1T21V⓪	LB⓪⓪L-A1T61⓪	LB⓪⓪L-A1T21V⓪	
		12V AC/DC	SPDT	LB⓪L-A1T53⓪	LB⓪L-A1T13V⓪	LB⓪⓪L-A1T53⓪	LB⓪⓪L-A1T13V⓪	
			DPDT	LB⓪L-A1T63⓪	LB⓪L-A1T23V⓪	LB⓪⓪L-A1T63⓪	LB⓪⓪L-A1T23V⓪	
		24V AC/DC	SPDT	LB⓪L-A1T54⓪	LB⓪L-A1T14V⓪	LB⓪⓪L-A1T54⓪	LB⓪⓪L-A1T14V⓪	
			DPDT	LB⓪L-A1T64⓪	LB⓪L-A1T24V⓪	LB⓪⓪L-A1T64⓪	LB⓪⓪L-A1T24V⓪	

- For Standard Bezel part numbers specify:
 - Bezel shape in place of ⓪. 1 (round), 2 (square), 3 (rectangular)
 - Lens/LED color in place of ⓪. A (amber), G (green), PW (white), R (red), S (blue), Y (yellow)
- For Flush Bezel part numbers specify:
 - Lens/LED in place of ⓪. A (amber), G (green), PW (white), R (red), S (blue), Y (yellow)
 - Bezel shape in place of ⓪. 6 (round), 7 (square), 8 (rectangular)
 - Bezel material in place of ⓪. M (metallic), Blank (black), G (black with guard)
- Solder/Tab terminals have silver contacts and PC Board Terminals have gold contacts.
- Illuminated pushbuttons contain an LED unit.
- See page page 524 for dimensions.
- See page page 539 for replacement LED units.
- Illuminated pushbuttons can be used with legend markings. Engraving can be done on a marking plate which is placed in the lens, or a clear film can be printed and placed in the lens. See page page 539 for details on the marking plate and film.

Switches & Pilot Devices

Signaling Lights

Relays & Sockets

Timers

Contactors

Terminal Blocks

Circuit Breakers

Illuminated Pushbuttons (Sub-assembled)



Contact Block

Terminal Style	Material	Contact	Part Number
	Silver	SPDT	LB-T50
		DPDT	LB-T60
	Gold	SPDT	LB-T10V
		DPDT	LB-T20V

LED Module

Style	Color	Voltage	Part Number
	Amber	5V	LB9Z-LED5A
		12V	LB9Z-LED1A
		24V	LB9Z-LED2A
	Green	5V	LB9Z-LED5G
		12V	LB9Z-LED1G
		24V	LB9Z-LED2G
	Red	5V	LB9Z-LED5R
		12V	LB9Z-LED1R
		24V	LB9Z-LED2R
	Blue	5V	LB9Z-LED5S
		12V	LB9Z-LED1S
		24V	LB9Z-LED2S
	White	5V	LB9Z-LED5PW
		12V	LB9Z-LED1PW
		24V	LB9Z-LED2PW
	Yellow	5V	LB9Z-LED5PW
		12V	LB9Z-LED1PW
		24V	LB9Z-LED2PW

Operator

Style	Mounting Style	Shape	Monmontary	Maintained
	Standard (Plastic)	Round	LB1L-M0	LB1L-A0
		Square	LB2L-M0	LB2L-A0
		Rectangular	LB3L-M0	LB3L-A0
	Flush Mount (Plastic)	Round	LB6L-M0	LB6L-A0
		Square	LB7L-M0	LB7L-A0
		Rectangular	LB8L-M0	LB8L-A0
	Flush Mount (Metallic)	Round	LB6ML-M0	LB6ML-A0
		Square	LB7ML-M0	LB7ML-A0
		Rectangular	LB8ML-M0	LB8ML-A0
	Flush Mount (Built-in switch guard)	Round	LB6GL-M0	LB6GL-A0
		Square	LB7GL-M0	LB7GL-A0
		Rectangular	LB8GL-M0	LB8GL-A0

Lens

Shape	Color	Part Number
	Amber	LB1A-L1A
	Green	LB1A-L1G
	Red	LB1A-L1R
	Blue	LB1A-L1S
	White	LB1A-L1W
	Yellow	LB1A-L1Y
	Amber	LB2A-L1A
	Green	LB2A-L1G
	Red	LB2A-L1R
	Blue	LB2A-L1S
	White	LB2A-L1W
	Yellow	LB2A-L1Y
	Amber	LB3A-L1A
	Green	LB3A-L1G
	Red	LB3A-L1R
	Blue	LB3A-L1S
	White	LB3A-L1W
Yellow	LB3A-L1Y	

Pilot Lights (Assembled)



Style	Operating Voltage	Standard Bezel		Flush Bezel		② Color Code
		Solder/Tab Terminal (silver contacts)	PC Board Terminal (gold contacts)	Solder/Tab Terminal (silver contacts)	PC Board Terminal (gold contacts)	
Standard Bezel (black) 	5V DC	LB⓪P-⓪T01⓪	LB⓪P-⓪T01V⓪	LB⓪⓪P-⓪T01⓪	LB⓪⓪P-⓪T01V⓪	Specify the color code in place of ② in the Part Number: A: amber G: green PW: white R: red S: blue Y: yellow
		LB⓪P-⓪T03⓪	LB⓪P-⓪T03V⓪	LB⓪⓪P-⓪T03⓪	LB⓪⓪P-⓪T03V⓪	
		LB⓪P-⓪T04⓪	LB⓪P-⓪T04V⓪	LB⓪⓪P-⓪T04⓪	LB⓪⓪P-⓪T04V⓪	
		LB⓪P-⓪T04⓪	LB⓪P-⓪T04V⓪	LB⓪⓪P-⓪T04⓪	LB⓪⓪P-⓪T04V⓪	
Flush Bezel (metallic or black) 	12V AC/DC	LB⓪P-⓪T03⓪	LB⓪P-⓪T03V⓪	LB⓪⓪P-⓪T03⓪	LB⓪⓪P-⓪T03V⓪	
	24V AC/DC	LB⓪P-⓪T04⓪	LB⓪P-⓪T04V⓪	LB⓪⓪P-⓪T04⓪	LB⓪⓪P-⓪T04V⓪	

- For Standard Bezel part numbers specify:
 - bezel shape in place of ⓪. 1 (round), 2 (square), 3 (rectangular)
 - lens/LED color in place of ②. A (amber), G (green), PW (white), R (red), S (blue), Y (yellow)
 - lens type code in place of ⓪. 1 (flat), 2 (dome with round lens)
- For Flush Bezel part numbers specify:
 - lens/LED in place of ②. A (amber), G (green), PW (white), R (red), S (blue), Y (yellow)
 - bezel shape in place of ⓪. 6 (round), 7 (square), 8 (rectangular)
 - bezel material in place of ⓪. M (metallic), Blank (black)
 - lens type code in place of ⓪. 1 (flat), 2 (dome with round lens)
- Pilot lights contain an LED unit.
- See page 524 for dimensions.
- See page 539 for replacement LED unit.

Pilot Lights (Sub-assembled)



Contact Block

Terminal Style	Part Number
 Solder Tab	LB-T00
 PCB	LB-T00V





LED Module

Style	Color	Voltage	Part Number
	Amber	5V	LB9Z-LED5A
		12V	LB9Z-LED1A
		24V	LB9Z-LED2A
Green	5V	LB9Z-LED5G	
	12V	LB9Z-LED1G	
	24V	LB9Z-LED2G	
Red	5V	LB9Z-LED5R	
	12V	LB9Z-LED1R	
	24V	LB9Z-LED2R	
Blue	5V	LB9Z-LED5S	
	12V	LB9Z-LED1S	
	24V	LB9Z-LED2S	
White	5V	LB9Z-LED5PW	
	12V	LB9Z-LED1PW	
	24V	LB9Z-LED2PW	
Yellow	5V	LB9Z-LED5PW	
	12V	LB9Z-LED1PW	
	24V	LB9Z-LED2PW	

Operator

Style	Mounting Style	Shape	Part Number
	Standard (Plastic)	Round	LB1P-0
		Square	LB2P-0
		Rectangular	LB3P-0
	Flush Mount (Plastic)	Round	LB6P-0
		Square	LB7P-0
		Rectangular	LB8P-0
	Flush Mount (Metallic)	Round	LB6MP-0
		Square	LB7MP-0
		Rectangular	LB8MP-0

Lens

Shape	Color	Part Number
	Amber	LB1A-P1A
	Green	LB1A-P1G
	Red	LB1A-P1R
	Blue	LB1A-P1S
	White	LB1A-P1W
	Yellow	LB1A-P1Y
	Amber	LB1A-P2A
	Green	LB1A-P2G
	Red	LB1A-P2R
	Blue	LB1A-P2S
	White	LB1A-P2W
	Yellow	LB1A-P2Y
	Amber	LB2A-P1A
	Green	LB2A-P1G
	Red	LB2A-P1R
	Blue	LB2A-P1S
	White	LB2A-P1W
	Yellow	LB2A-P1Y
	Amber	LB3A-P1A
	Green	LB3A-P1G
	Red	LB3A-P1R
	Blue	LB3A-P1S
	White	LB3A-P1W
	Yellow	LB3A-P1Y

Non-Illuminated Pushbuttons (Assembled)

Style	Operation	Contact	Standard Bezel		Flush Bezel		Ⓢ Color Code
			Solder/Tab Terminal (silver contacts)	PC Board Terminal (gold contacts)	Solder/Tab Terminal (silver contacts)	PC Board Terminal (gold contacts)	
Standard Bezel (black)   	Momentary	SPDT	LBⓉB-M1T5Ⓢ	LBⓉB-M1T1VⓈ	LBⓈⓈB-M1T5Ⓢ	LBⓈⓈB-M1T1VⓈ	Specify the color code in place of Ⓢ in the Part Number: B: black G: green R: red S: blue W: white Y: yellow
		DPDT	LBⓉB-M1T6Ⓢ	LBⓉB-M1T2VⓈ	LBⓈⓈB-M1T6Ⓢ	LBⓈⓈB-M1T2VⓈ	
		3PDT	LBⓉB-M1T7Ⓢ	LBⓉB-M1T3VⓈ	LBⓈⓈB-M1T7Ⓢ	LBⓈⓈB-M1T3VⓈ	
Flush Bezel (metallic or black)   	Maintained	SPDT	LBⓉB-A1T5Ⓢ	LBⓉB-A1T1VⓈ	LBⓈⓈB-A1T5Ⓢ	LBⓈⓈB-A1T1VⓈ	
		DPDT	LBⓉB-A1T6Ⓢ	LBⓉB-A1T2VⓈ	LBⓈⓈB-A1T6Ⓢ	LBⓈⓈB-A1T2VⓈ	
		3PDT	LBⓉB-A1T7Ⓢ	LBⓉB-A1T3VⓈ	LBⓈⓈB-A1T7Ⓢ	LBⓈⓈB-A1T3VⓈ	
Black Bezel with Guard 		3PDT	LBⓉB-A1T7Ⓢ	LBⓉB-A1T3VⓈ	LBⓈⓈB-A1T7Ⓢ	LBⓈⓈB-A1T3VⓈ	

- For Standard Bezel part numbers specify:
 - bezel shape in place of Ⓣ. 1 (round), 2 (square), 3 (rectangular)
 - lens/LED in place of Ⓢ. B (black), G (green), R (red), S (blue), W (white), Y (yellow)
- For Flush Bezel part numbers specify:
 - lens/LED in place of Ⓢ. B (black), G (green), R (red), S (blue), W (white), Y (yellow)
 - bezel shape in place of Ⓣ. 6 (round), 7 (square), 8 (rectangular)
 - bezel material in place of Ⓢ. M (metallic), Blank (black)
- See page page 526 for dimensions.
- Lens can be used with legend markings. Engraving can be done on a marking plate which is placed into the lens, or a clear film can be printed and placed under the lens. For details on the marking plate and film, see page page 539.

Switches & Pilot Devices

Signaling Lights

Relays & Sockets

Timers

Contactors

Terminal Blocks

Circuit Breakers

Non-Illuminated Pushbuttons (Sub-assembled)

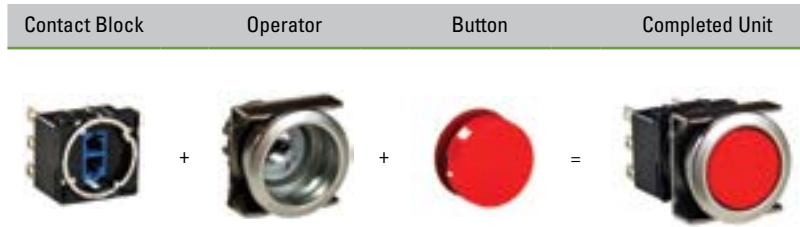

Contact Block

Terminal Style	Material	Contact	Part Number
	Solder/Tab	Silver	SPDT LB-T5
			DPDT LB-T6
			3PDT LB-T7
	PCB	Gold	SPDT LB-T1V
			DPDT LB-T2V
			3PDT LB-T3V









Operator

Style	Mounting style	Shape	Momentary	Maintained
	Standard (Plastic)	Round	LB1L-M0	LB1L-A0
		Square	LB2L-M0	LB2L-A0
		Rectangular	LB3L-M0	LB3L-A0
	Flush Mount (Plastic)	Round	LB6L-M0	LB6L-A0
		Square	LB7L-M0	LB7L-A0
		Rectangular	LB8L-M0	LB8L-A0
	Flush Mount (Metallic)	Round	LB6ML-M0	LB6ML-A0
		Square	LB7ML-M0	LB7ML-A0
		Rectangular	LB8ML-M0	LB8ML-A0
	Flush Mount (Built-in switch guard)	Round	LB6GL-M0	LB6GL-A0
		Square	LB7GL-M0	LB7GL-A0
		Rectangular	LB8GL-M0	LB8GL-A0

Button

Style	Color	Part Number
	Round	Black LB1A-B1B
	Round	Green LB1A-B1G
	Round	Red LB1A-B1R
	Round	Blue LB1A-B1S
	Round	White LB1A-B1W
	Round	Yellow LB1A-B1Y
	Square	Black LB2A-B1B
	Square	Green LB2A-B1G
	Square	Red LB2A-B1R
	Square	Blue LB2A-B1S
	Square	White LB2A-B1W
	Square	Yellow LB2A-B1Y
	Rectangular	Black LB3A-B1B
	Rectangular	Green LB3A-B1G
	Rectangular	Red LB3A-B1R
	Rectangular	Blue LB3A-B1S
	Rectangular	White LB3A-B1W
	Rectangular	Yellow LB3A-B1Y

Selector Switches (Assembled)

Style	Operator Position	Contact	Standard Bezel		Flush Bezel		
			Solder/Tab Terminal (silver contacts)	PC Board Terminal (gold contacts)	Solder/Tab Terminal (silver contacts)	PC Board Terminal (gold contacts)	
Standard Bezel (black)  lever shown	90° 2-position	Maintained 	SPDT	LB①S-2⑤T5	LB①S-2⑤T1V	LB③④S-2⑤T5	LB③④S-2⑤T1V
			DPDT	LB①S-2⑤T6	LB①S-2⑤T2V	LB③④S-2⑤T6	LB③④S-2⑤T2V
			3PDT	LB①S-2⑤T7	LB①S-2⑤T3V	LB③④S-2⑤T7	LB③④S-2⑤T3V
		Spring return from right 	SPDT	LB①S-21⑤T5	LB①S-21⑤T1V	LB③④S-21⑤T5	LB③④S-21⑤T1V
			DPDT	LB①S-21⑤T6	LB①S-21⑤T2V	LB③④S-21⑤T6	LB③④S-21⑤T2V
			3PDT	LB①S-21⑤T7	LB①S-21⑤T3V	LB③④S-21⑤T7	LB③④S-21⑤T3V
Flush Bezel (metallic or black)  lever shown	45° 3-position	Maintained 	DPDT	LB①S-3⑤T6	LB①S-3⑤T2V	LB③④S-3⑤T6	LB③④S-3⑤T2V
			3PDT	LB①S-3⑤T7	LB①S-3⑤T3V	LB③④S-3⑤T7	LB③④S-3⑤T3V
			Spring return from right 	DPDT	LB①S-31⑤T6	LB①S-31⑤T2V	LB③④S-31⑤T6
		3PDT		LB①S-31⑤T7	LB①S-31⑤T3V	LB③④S-31⑤T7	LB③④S-31⑤T3V
		Spring return from left 		DPDT	LB①S-32⑤T6	LB①S-32⑤T2V	LB③④S-32⑤T6
			3PDT	LB①S-32⑤T7	LB①S-32⑤T3V	LB③④S-32⑤T7	LB③④S-32⑤T3V
			Spring return two-way 	DPDT	LB①S-33⑤T6	LB①S-33⑤T2V	LB③④S-33⑤T6
		3PDT		LB①S-33⑤T7	LB①S-33⑤T3V	LB③④S-33⑤T7	LB③④S-33⑤T3V

Knob models shown above unless otherwise indicated.

- For Standard Bezel part numbers specify:
 - bezel shape in place of ①. 1 (round), 2 (square), 3 (rectangular)
 - operator shape in place of ⑤. blank (knob), L (lever).
- For Flush Bezel part numbers specify:
 - bezel shape in place of ③. 6 (round), 7 (square), 8 (rectangular)
 - bezel material in place of ④. M (metallic), Blank (black)
 - operator shape in place of ⑤. blank (knob), L (lever).
- See page page 522 for contact operation .
- See page page 528 for dimensions.

Switches & Pilot Devices

Signaling Lights

Relays & Sockets

Timers

Contactors

Terminal Blocks

Circuit Breakers

Selector Switches (Sub-assembled)



Contact Block

Terminal Style	Material	Contact	Part Number
	Silver	SPDT	LB-T5
		DPDT	LB-T6
		3PDT	LB-T7
	Gold	SPDT	LB-T1V
		DPDT	LB-T2V
		3PDT	LB-T3V

SPDT contacts applicable for 2-position switches only.

Operator

Style	Shape	Position	Function	Part Number		
				Knob	Lever	
Standard (Plastic) 	Round	2	Maintained	LB1S-2Y	LB1S-2L	
			Spring from right	LB1S-21Y	LB1S-21L	
		3	Maintained	LB1S-3Y	LB1S-3L	
			Spring from right	LB1S-31Y	LB1S-31L	
			Spring from left	LB1S-32Y	LB1S-32L	
		Spring from both	LB1S-33Y	LB1S-33L		
	Rectangular	Square	2	Maintained	LB2S-2Y	LB2S-2L
				Spring from right	LB2S-21Y	LB2S-21L
			3	Maintained	LB2S-3Y	LB2S-3L
		Spring from right		LB2S-31Y	LB2S-31L	
		Spring from left		LB2S-32Y	LB2S-32L	
		Spring from both	LB2S-33Y	LB2S-33L		
		Rectangular	2	Maintained	LB3S-2Y	LB3S-2L
				Spring from right	LB3S-21Y	LB3S-21L
			3	Maintained	LB3S-3Y	LB3S-3L
Spring from right	LB3S-31Y			LB3S-31L		
Spring from left	LB3S-32Y			LB3S-32L		
Spring from both	LB3S-33Y			LB3S-33L		

Style	Shape	Position	Function	Part Number		
				Knob	Lever	
Flush Mount (Plastic) 	Round	2	Maintained	LB6S-2Y	LB6S-2L	
			Spring from right	LB6S-21Y	LB6S-21L	
		3	Maintained	LB6S-3Y	LB6S-3L	
			Spring from right	LB6S-31Y	LB6S-31L	
			Spring from left	LB6S-32Y	LB6S-32L	
			Spring from both	LB6S-33Y	LB6S-33L	
Round 	Square	2	Maintained	LB7S-2Y	LB7S-2L	
			Spring from right	LB7S-21Y	LB7S-21L	
		3	Maintained	LB7S-3Y	LB7S-3L	
	Spring from right		LB7S-31Y	LB7S-31L		
	Spring from left		LB7S-32Y	LB7S-32L		
	Spring from both	LB7S-33Y	LB7S-33L			
Rectangular 	Rectangular	2	Maintained	LB8S-2Y	LB8S-2L	
			Spring from right	LB8S-21Y	LB8S-21L	
		3	Maintained	LB8S-3Y	LB8S-3L	
			Spring from right	LB8S-31Y	LB8S-31L	
			Spring from left	LB8S-32Y	LB8S-32L	
			Spring from both	LB8S-33Y	LB8S-33L	
	Round 	Round	2	Maintained	LB6MS-2Y	LB6MS-2L
				Spring from right	LB6MS-21Y	LB6MS-21L
			3	Maintained	LB6MS-3Y	LB6MS-3L
		Spring from right		LB6MS-31Y	LB6MS-31L	
		Spring from left		LB6MS-32Y	LB6MS-32L	
		Spring from both	LB6MS-33Y	LB6MS-33L		
Square 	Square	2	Maintained	LB7MS-2Y	LB7MS-2L	
			Spring from right	LB7MS-21Y	LB7MS-21L	
		3	Maintained	LB7MS-3Y	LB7MS-3L	
	Spring from right		LB7MS-31Y	LB7MS-31L		
	Spring from left		LB7MS-32Y	LB7MS-32L		
	Spring from both	LB7MS-33Y	LB7MS-33L			
Rectangular 	Rectangular	2	Maintained	LB8MS-2Y	LB8MS-2L	
			Spring from right	LB8MS-21Y	LB8MS-21L	
		3	Maintained	LB8MS-3Y	LB8MS-3L	
	Spring from right		LB8MS-31Y	LB8MS-31L		
	Spring from left		LB8MS-32Y	LB8MS-32L		
	Spring from both	LB8MS-33Y	LB8MS-33L			

Illuminated Selector Switches (Assembled)

Style	Operating Voltage	Operator Position	Contact	Standard Bezel		Flush Bezel				
				Solder/Tab Terminal (silver contacts)	PC Board Terminal (gold contacts)	Solder/Tab Terminal (silver contacts)	PC Board Terminal (gold contacts)			
Standard Bezel (black)   	5V DC	90° 2-position	Maintained L R	SPDT	LB⓪F-2T51⓪	LB⓪F-2T11V⓪	LB6⓪F-2T51⓪	LB6⓪F-2T11V⓪		
				DPDT	LB⓪F-2T61⓪	LB⓪F-2T21V⓪	LB6⓪F-2T61⓪	LB6⓪F-2T21V⓪		
	12V AC/DC	90° 2-position	Maintained L R		DPDT	LB⓪F-3T61⓪	LB⓪F-3T21V⓪	LB6⓪F-3T61⓪	LB6⓪F-3T21V⓪	
					SPDT	LB⓪F-2T53⓪	LB⓪F-2T13V⓪	LB6⓪F-2T53⓪	LB6⓪F-2T13V⓪	
	Flush Bezel (metallic or black)  	24V AC/DC	90° 2-position	Maintained L R		DPDT	LB⓪F-2T63⓪	LB⓪F-2T23V⓪	LB6⓪F-2T63⓪	LB6⓪F-2T23V⓪
						SPDT	LB⓪F-3T63⓪	LB⓪F-3T23V⓪	LB6⓪F-3T63⓪	LB6⓪F-3T23V⓪
45° 3-position		Maintained L C R		DPDT	LB⓪F-2T54⓪	LB⓪F-2T14V⓪	LB6⓪F-2T54⓪	LB6⓪F-2T14V⓪		
			DPDT	LB⓪F-2T64⓪	LB⓪F-2T24V⓪	LB6⓪F-2T64⓪	LB6⓪F-2T24V⓪			
	24V AC/DC	45° 3-position	Maintained L C R	DPDT	LB⓪F-3T64⓪	LB⓪F-3T24V⓪	LB6⓪F-3T64⓪	LB6⓪F-3T24V⓪		

Flush bezel only available with round operator.

9. For Standard Bezel part numbers specify:
 - bezel shape in place of ⓪. 1 (round), 2 (square), 3 (rectangular)
 - color code in place of ⓪. A (amber), G (green), R (red), S (blue), PW (white), Y (yellow)
10. For Flush Bezel part numbers specify:
 - color code in place of ⓪. A (amber), G (green), R (red), S (blue), PW (white), Y (yellow)
 - bezel material in place of ⓪. M (metallic), Blank (black)
11. See page page 522 for contact operation.
12. See page page 530 for dimensions.

Switches & Pilot Devices

Signaling Lights

Relays & Sockets

Timers

Contactors

Terminal Blocks

Circuit Breakers

Illuminated Selector Switches (Sub-assembled)

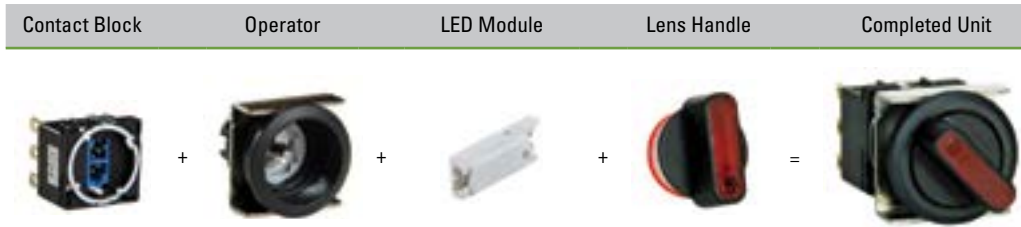

Contact Block

Terminal Style	Material	Contact	Part Number
	Silver	SPDT	LB-T50
		DPDT	LB-T60
	Gold	SPDT	LB-T10
		DPDT	LB-T20
	Gold	SPDT	LB-T10V
		DPDT	LB-T20V

SPDT contacts applicable for 2-position switches only.

Operator

Style	Shape	Position	Function	Part Number
	Round	2	Maintained	LB1F-2
		3	Maintained	LB1F-3
	Square	2	Maintained	LB2F-2
		3	Maintained	LB2F-3
	Rectangular	2	Maintained	LB3F-2
		3	Maintained	LB3F-3
	Round	2	Maintained	LB6F-2
		3	Maintained	LB6F-3
	Round	2	Maintained	LB6MF-2
		3	Maintained	LB6MF-3

LED Module

Style	Color	Voltage	Part Number
	Amber	5V	LB9Z-LED5A
		12V	LB9Z-LED1A
		24V	LB9Z-LED2A
Green	5V	LB9Z-LED5G	
	12V	LB9Z-LED1G	
	24V	LB9Z-LED2G	
Red	5V	LB9Z-LED5R	
	12V	LB9Z-LED1R	
	24V	LB9Z-LED2R	
Blue	5V	LB9Z-LED5S	
	12V	LB9Z-LED1S	
	24V	LB9Z-LED2S	
White	5V	LB9Z-LED5PW	
	12V	LB9Z-LED1PW	
	24V	LB9Z-LED2PW	
Yellow	5V	LB9Z-LED5PY	
	12V	LB9Z-LED1PY	
	24V	LB9Z-LED2PY	

Lens Handle

Style	Color	Part Number
	Amber	LA1A-FA
	Green	LA1A-FG
	Red	LA1A-FR
	Blue	LA1A-FS
	White	LA1A-FW
	Yellow	LA1A-FY

Key Selector Switches (Assembled)

Style	Operator Position	Key retained at ●	Contact	Standard Bezel		Flush Bezel		
				Solder/Tab Terminal (silver contacts)	PC Board Terminal (gold contacts)	Solder/Tab Terminal (silver contacts)	PC Board Terminal (gold contacts)	
Standard Bezel (black) 	90° 2-position	Maintained		SPDT	LB⊙K-2T5A	LB⊙K-2T1VA	LB⊙⊕K-2T5A	LB⊙⊕K-2T1VA
				DPDT	LB⊙K-2T6A	LB⊙K-2T2VA	LB⊙⊕K-2T6A	LB⊙⊕K-2T2VA
				3PDT	LB⊙K-2T7A	LB⊙K-2T3VA	LB⊙⊕K-2T7A	LB⊙⊕K-2T3VA
				SPDT	LB⊙K-2T5B	LB⊙K-2T1VB	LB⊙⊕K-2T5B	LB⊙⊕K-2T1VB
				DPDT	LB⊙K-2T6B	LB⊙K-2T2VB	LB⊙⊕K-2T6B	LB⊙⊕K-2T2VB
				3PDT	LB⊙K-2T7B	LB⊙K-2T3VB	LB⊙⊕K-2T7B	LB⊙⊕K-2T3VB
	Spring return from right		SPDT	LB⊙K-2T5C	LB⊙K-2T1VC	LB⊙⊕K-2T5C	LB⊙⊕K-2T1VC	
			DPDT	LB⊙K-2T6C	LB⊙K-2T2VC	LB⊙⊕K-2T6C	LB⊙⊕K-2T2VC	
			3PDT	LB⊙K-2T7C	LB⊙K-2T3VC	LB⊙⊕K-2T7C	LB⊙⊕K-2T3VC	
				SPDT	LB⊙K-21T5B	LB⊙K-21T1VB	LB⊙⊕K-21T5B	LB⊙⊕K-21T1VB
				DPDT	LB⊙K-21T6B	LB⊙K-21T2VB	LB⊙⊕K-21T6B	LB⊙⊕K-21T2VB
				3PDT	LB⊙K-21T7B	LB⊙K-21T3VB	LB⊙⊕K-21T7B	LB⊙⊕K-21T3VB
Flush Bezel (metallic or black) 	45° 3-position	Maintained		DPDT	LB⊙K-3T6A	LB⊙K-3T2VA	LB⊙⊕K-3T6A	LB⊙⊕K-3T2VA
				3PDT	LB⊙K-3T7A	LB⊙K-3T3VA	LB⊙⊕K-3T7A	LB⊙⊕K-3T3VA
				DPDT	LB⊙K-3T6B	LB⊙K-3T2VB	LB⊙⊕K-3T6B	LB⊙⊕K-3T2VB
				3PDT	LB⊙K-3T7B	LB⊙K-3T3VB	LB⊙⊕K-3T7B	LB⊙⊕K-3T3VB
				DPDT	LB⊙K-3T6C	LB⊙K-3T2VC	LB⊙⊕K-3T6C	LB⊙⊕K-3T2VC
				3PDT	LB⊙K-3T7C	LB⊙K-3T3VC	LB⊙⊕K-3T7C	LB⊙⊕K-3T3VC
				DPDT	LB⊙K-3T6D	LB⊙K-3T2VD	LB⊙⊕K-3T6D	LB⊙⊕K-3T2VD
				3PDT	LB⊙K-3T7D	LB⊙K-3T3VD	LB⊙⊕K-3T7D	LB⊙⊕K-3T3VD
				DPDT	LB⊙K-3T6E	LB⊙K-3T2VE	LB⊙⊕K-3T6E	LB⊙⊕K-3T2VE
				3PDT	LB⊙K-3T7E	LB⊙K-3T3VE	LB⊙⊕K-3T7E	LB⊙⊕K-3T3VE
				DPDT	LB⊙K-3T6G	LB⊙K-3T2VG	LB⊙⊕K-3T6G	LB⊙⊕K-3T2VG
				3PDT	LB⊙K-3T7G	LB⊙K-3T3VG	LB⊙⊕K-3T7G	LB⊙⊕K-3T3VG
				DPDT	LB⊙K-3T6H	LB⊙K-3T2VH	LB⊙⊕K-3T6H	LB⊙⊕K-3T2VH
				3PDT	LB⊙K-3T7H	LB⊙K-3T3VH	LB⊙⊕K-3T7H	LB⊙⊕K-3T3VH

Assembled Key Selector Switches con't on next page.

Switches & Pilot Devices

Signaling Lights

Relays & Sockets

Timers

Contactors

Terminal Blocks

Circuit Breakers

Assembled Key Selector Switches con't on next page.

Style	Operator Position	Key retained at ●	Contact	Standard Bezel		Flush Bezel		
				Solder/Tab Terminal (silver contacts)	PC Board Terminal (gold contacts)	Solder/Tab Terminal (silver contacts)	PC Board Terminal (gold contacts)	
Standard Bezel (black)  Flush Bezel (metallic or black) 	45° 3-position	Spring return from right	 B	DPDT	LB⓪K-31T6B	LB⓪K-31T2VB	LB⓪⓪K-31T6B	LB⓪⓪K-31T2VB
				3PDT	LB⓪K-31T7B	LB⓪K-31T3VB	LB⓪⓪K-31T7B	LB⓪⓪K-31T3VB
			 D	DPDT	LB⓪K-31T6D	LB⓪K-31T2VD	LB⓪⓪K-31T6D	LB⓪⓪K-31T2VD
				3PDT	LB⓪K-31T7D	LB⓪K-31T3VD	LB⓪⓪K-31T7D	LB⓪⓪K-31T3VD
			 G	DPDT	LB⓪K-31T6G	LB⓪K-31T2VG	LB⓪⓪K-31T6G	LB⓪⓪K-31T2VG
				3PDT	LB⓪K-31T7G	LB⓪K-31T3VG	LB⓪⓪K-31T7G	LB⓪⓪K-31T3VG
		Spring return from left	 C	DPDT	LB⓪K-32T6C	LB⓪K-32T2VC	LB⓪⓪K-32T6C	LB⓪⓪K-32T2VC
				3PDT	LB⓪K-32T7C	LB⓪K-32T3VC	LB⓪⓪K-32T7C	LB⓪⓪K-32T3VC
			 D	DPDT	LB⓪K-32T6D	LB⓪K-32T2VD	LB⓪⓪K-32T6D	LB⓪⓪K-32T2VD
				3PDT	LB⓪K-32T7D	LB⓪K-32T3VD	LB⓪⓪K-32T7D	LB⓪⓪K-32T3VD
			 H	DPDT	LB⓪K-32T6H	LB⓪K-32T2VH	LB⓪⓪K-32T6H	LB⓪⓪K-32T2VH
				3PDT	LB⓪K-32T7H	LB⓪K-32T3VH	LB⓪⓪K-32T7H	LB⓪⓪K-32T3VH
Spring return two-way	 D	DPDT	LB⓪K-33T6D	LB⓪K-33T2VD	LB⓪⓪K-33T6D	LB⓪⓪K-33T2VD		
		3PDT	LB⓪K-33T7D	LB⓪K-33T3VD	LB⓪⓪K-33T7D	LB⓪⓪K-33T3VD		

- 13. Key is retained at ● and removable at ○ positions.
- 14. Two keys are supplied.
- 15. For Standard Bezel part numbers specify bezel shape in place of ⓪. 1 (round), 2 (square), 3 (rectangular)
- 16. For Flush Bezel part numbers specify:
 - bezel shape in place of ⓪. 6 (round), 7 (square), 8 (rectangular)
 - bezel material in place of ⓪. M (metallic), Blank (black)
- 17. See page page 522 for contact operation.
- 18. See page page 531 for dimensions.
- 19. For additional security, wave keys also available.
 - Add the letter "S" before the "T" in the part no. Example: LB1K-31ST1A
 - Besides the standard wave key (key number 0H), six other keys are available.
 - To order other keys, specify the key number as shown below:
 - Example: LB1K-31ST2B-1H (Key number is indicated on the key cylinder. Standard keys do not have a key number indication.)
 - _____ (blank): Standard wave key (0H)
 - 1H to 2H: Reversible wave key
 - 3H to 6H: Non-reversible wave key
- 20. If ordering standard wave key (0H), subcomponents are available, see next page.
- 21. If ordering other than standard wave key (for example, key number 6H), only completed switches are available.

Switches & Pilot Devices

Signaling Lights

Relays & Sockets

Timers

Contactors

Terminal Blocks

Circuit Breakers

Key Selector Switches (Sub-assembled)

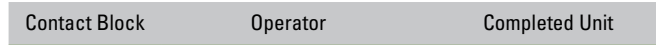

Contact Block

Terminal Style	Material	Contact	Part Number
	Solder/Tab	Silver	SPDT LB-T5
			DPDT LB-T6
			3PDT LB-T7
	PCB	Gold	SPDT LB-T1V
			DPDT LB-T2V
			3PDT LB-T3V

Operator

Style	Shape	Position	Function	Part number
	Round	2	Maintained	LB1K-2 [Ⓢ]
			Spring from right	LB1K-21B
		3	Maintained	LB1K-3 [Ⓢ]
			Spring from right	LB1K-31 [Ⓢ]
			Spring from left	LB1K-32 [Ⓢ]
			Spring from both	LB1K-33D
	Square	2	Maintained	LB2K-2 [Ⓢ]
			Spring from right	LB2K-21B
		3	Maintained	LB2K-3 [Ⓢ]
			Spring from right	LB2K-31 [Ⓢ]
			Spring from left	LB2K-32 [Ⓢ]
			Spring from both	LB2K-33D
	Rectangular	2	Maintained	LB3K-2 [Ⓢ]
			Spring from right	LB3K-21B
		3	Maintained	LB3K-3 [Ⓢ]
			Spring from right	LB3K-31 [Ⓢ]
			Spring from left	LB3K-32 [Ⓢ]
			Spring from both	LB3K-33D

Style	Shape	Position	Function	Part number	
	Round	2	Maintained	LB6K-2 [Ⓢ]	
			Spring from right	LB6K-21B	
		3	Maintained	LB6K-3 [Ⓢ]	
			Spring from right	LB6K-31 [Ⓢ]	
			Spring from left	LB6K-32 [Ⓢ]	
			Spring from both	LB6K-33D	
	Square	2	Maintained	LB7K-2 [Ⓢ]	
			Spring from right	LB7K-21B	
		3	Maintained	LB7K-3 [Ⓢ]	
			Spring from right	LB7K-31 [Ⓢ]	
			Spring from left	LB7K-32 [Ⓢ]	
			Spring from both	LB7K-33D	
		Rectangular	2	Maintained	LB8K-2 [Ⓢ]
				Spring from right	LB8K-21B
			3	Maintained	LB8K-3 [Ⓢ]
				Spring from right	LB8K-31 [Ⓢ]
				Spring from left	LB8K-32 [Ⓢ]
				Spring from both	LB8K-33D
Round		2	Maintained	LB6MK-2 [Ⓢ]	
			Spring from right	LB6MK-21B	
		3	Maintained	LB6MK-3 [Ⓢ]	
			Spring from right	LB6MK-31 [Ⓢ]	
			Spring from left	LB6MK-32 [Ⓢ]	
			Spring from both	LB6MK-33D	
Square		2	Maintained	LB7MK-2 [Ⓢ]	
			Spring from right	LB7MK-21B	
		3	Maintained	LB7MK-3 [Ⓢ]	
			Spring from right	LB7MK-31 [Ⓢ]	
			Spring from left	LB7MK-32 [Ⓢ]	
			Spring from both	LB7MK-33D	
Rectangular	2	Maintained	LB8MK-2 [Ⓢ]		
		Spring from right	LB8MK-21B		
	3	Maintained	LB8MK-3 [Ⓢ]		
		Spring from right	LB8MK-31 [Ⓢ]		
		Spring from left	LB8MK-32 [Ⓢ]		
		Spring from both	LB8MK-33D		





22. In place of [Ⓢ] specify retention option code from table below.
 23. For standard wave key operators, add "S" to part number before the key retention code from table below. (For example, LB6K-2B with wave key would be LB6K-2SB.)

[Ⓢ] Retention Option Code

Code	Description	Code	Description
A	Key not retained in any position (removable in all positions)	E	Key retained in center only (3-position only)
B	Key retained in right position only	G	Key retained in right and center (3-position only)
C	Key retained in left position only	H	Key retained in left and center (3-position only)
D	Key retained in left and right (3-position only)		

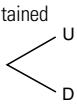
Switches & Pilot Devices

Lever Switches (Assembled)

Style	Operator Position	Contact	Solder/Tab Terminal (silver contacts)	PC Board Terminal (gold contacts)
Standard Bezel (black) 	2-position	Maintained 	SPDT LB⊙T-2T5	LB⊙T-2T1V
			DPDT LB⊙T-2T6	LB⊙T-2T2V
			3PDT LB⊙T-2T7	LB⊙T-2T3V
Flush Bezel (black) 	3-position	Maintained 	DPDT LB⊙T-3T2	LB⊙T-3T6V
			3PDT LB⊙T-3T3	LB⊙T-3T7V
		Spring return from top/bottom 	DPDT LB⊙T-33T2	LB⊙T-33T6V
			3PDT LB⊙T-33T3	LB⊙T-33T7V

Signaling Lights

Relays & Sockets

24. For all part numbers, specify bezel in place of ⊙. 1 (standard bezel), 6 (flush bezel).
 25. See page page 522 for contact operation.
 26. See page page 533 for dimensions.



Lever Switches (Sub-assembled)



Timers

Contactors

Contact Block

Terminal Style	Material	Contact	Part Number
 Solder/Tab	Silver	SPDT	LB-T5
		DPDT	LB-T6
		3PDT	LB-T7
	Gold	SPDT	LB-T1
		DPDT	LB-T2
		3PDT	LB-T3
 PCB	Gold	SPDT	LB-T1V
		DPDT	LB-T2V
		3PDT	LB-T3V

Terminal Blocks

Operator

Style	Position	Function	Part Number
Round Standard (Plastic) 	2	Maintained	LB1T-2
		Maintained	LB1T-3
	3	Spring return from both	LB1T-33
Round Flush Mount (Plastic) 	2	Maintained	LB6T-2
		Maintained	LB6T-3
	3	Spring return from both	LB6T-33

Circuit Breakers

Buzzers (Assembled)

Style	Shape	Voltage	Standard Bezel		Flush Bezel	
			Solder/Tab Terminal	PC Board Terminal	Solder/Tab Terminal	PC Board Terminal
Black Bezel   	Round	12V DC	–	–	LB6Z-1T03	LB6Z-1T03V
		24V DC	–	–	LB6Z-1T04	LB6Z-1T04V
	Rectangular	12V DC	LB3Z-1T03	LB3Z-1T03V	LB8Z-1T03	LB8Z-1T03V
		24V DC	LB3Z-1T04	LB3Z-1T04V	LB8Z-1T04	LB8Z-1T04V
Metallic Bezel  	Round	12V DC	–	–	LB6MZ-1T03	LB6MZ-1T03V
		24V DC	–	–	LB6MZ-1T04	LB6MZ-1T04V
	Rectangular	12V DC	–	–	LB8MZ-1T03	LB8MZ-1T03V
		24V DC	–	–	LB8MZ-1T04	LB8MZ-1T04V

27. IP54 Rated.
 28. For IP40 rating, use part number LB3Z-104K.
 29. See page 534 for dimensions.

Buzzers (Sub-assembled)

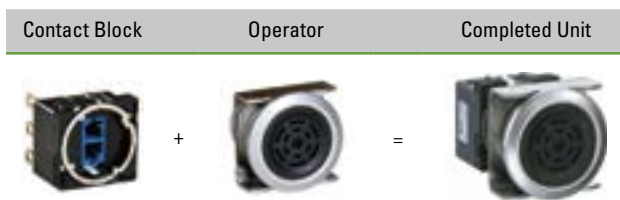

Contact Block

Terminal Style	Part Number
 Solder/Tab	LB-T00
 PCB	LB-T00V

Operator

Style	Mounting Style	Shape	Voltage	
			12V DC	24V DC
	Standard (Plastic)	Rectangular	LB3Z-103	LB3Z-104
		Round	LB6Z-103	LB6Z-104
	Flush Mount (Plastic)	Rectangular	LB8Z-103	LB8Z-104
		Round	LB6MZ-103	LB6MZ-104
	Flush Mount (Metallic)	Rectangular	LB8MZ-103	LB8MZ-104

Contact Operation

Selector Switch, Illuminated Selector Switch, Key Selector Switch

Operator Position & Contact Operation (Top View)

Position		Contact	Left	Center	Right
90° 2-position	<p>Maintained</p>	SPDT			
		DPDT			
		3PDT			
45° 3-position	<p>Maintained</p>	DPDT			
		3PDT			
45° 3-position	<p>Spring return from right</p>	<p>Spring return from left</p>	<p>Spring return two-way</p>	DPDT	
				DPDT	
				DPDT	
				3PDT	
3PDT					
3PDT					

Lever Switch

Lever Position & Contact Operation (Top View)

Position		Contact	Down	Center	Up
90° 2-position	<p>Maintained</p>	SPDT			
		DPDT			
		3PDT			
45° 3-position	<p>Maintained</p>	<p>Spring return two-way</p>	DPDT		
			3PDT		

Mounting Hole Layout (mm)

Standard Bezels

LB1/LB2/LB3

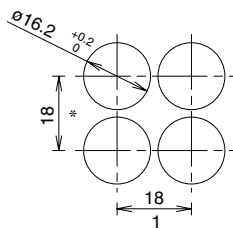

*1. Rectangular: 24mm
3PDT: 23.2mm
*2. 3PDT: 21mm

Flush Bezels

Round

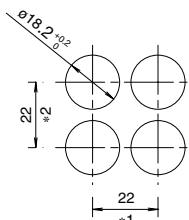

Square

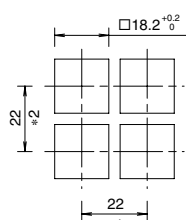

Rectangular

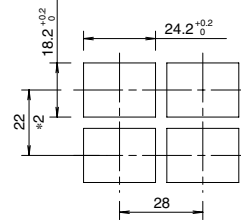

1. 3PDT: 23.2mm
2. Switches with Guard: 45mm

When using the LB series with a rubber boot or terminal cover, make sure to note the dimensions on pages page 537 and page 538.

PC Board Drilling Layout (mm)

Notes for Designing PC Board and Circuit

1. Use 1.6mm-thick glass epoxy PC board with drilled holes.
2. Design a circuit so that the LB series can operate within the rated voltage and current range. Make sure that inrush current and voltage do not exceed the rating.
3. Minimum applicable load is 5V AC/DC, 1mA on gold contacts.
4. Since the *2.8mm-wide terminal touches the PC board as shown below, short circuit may occur with pattern lines. Design a circuit that prevents short circuits.

SPDT/DPDT Contacts

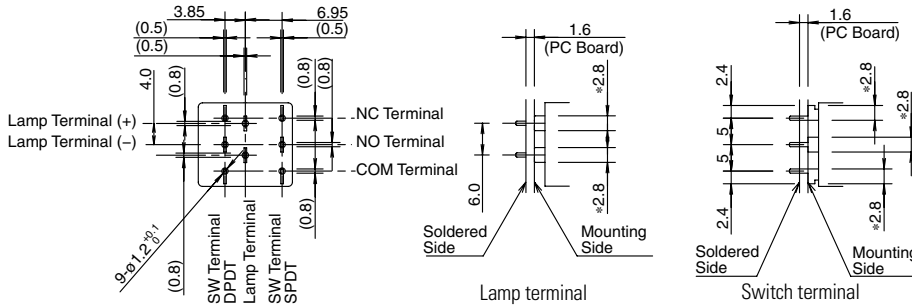

3PDT Contacts

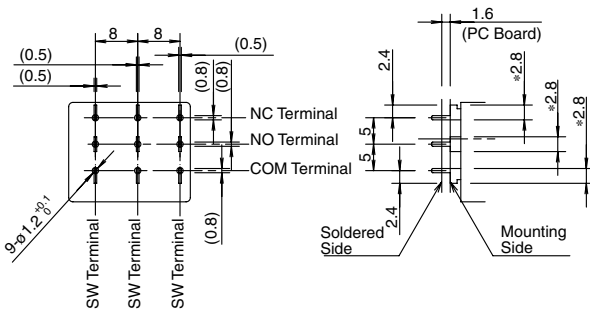

PC Board Drilling Layout (Bottom View)

SPDT/DPDT Contacts

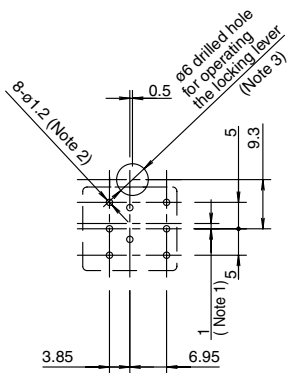

3PDT Contacts

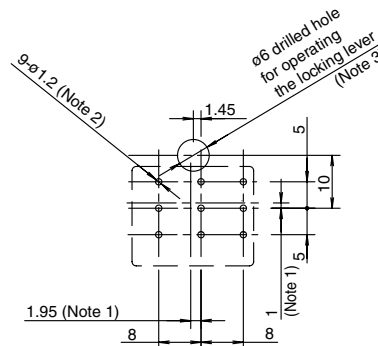

5. When designing, note the alignment of the center lines of the contact blocks and operators.
6. The diameter of the terminal hole is ø1.2.
7. Hole diameter may vary to meet installation requirements. Determine the location and the size of the hole so that the locking lever can be operated.

Dimensions (mm) Illuminated Pushbuttons

Standard Bezels

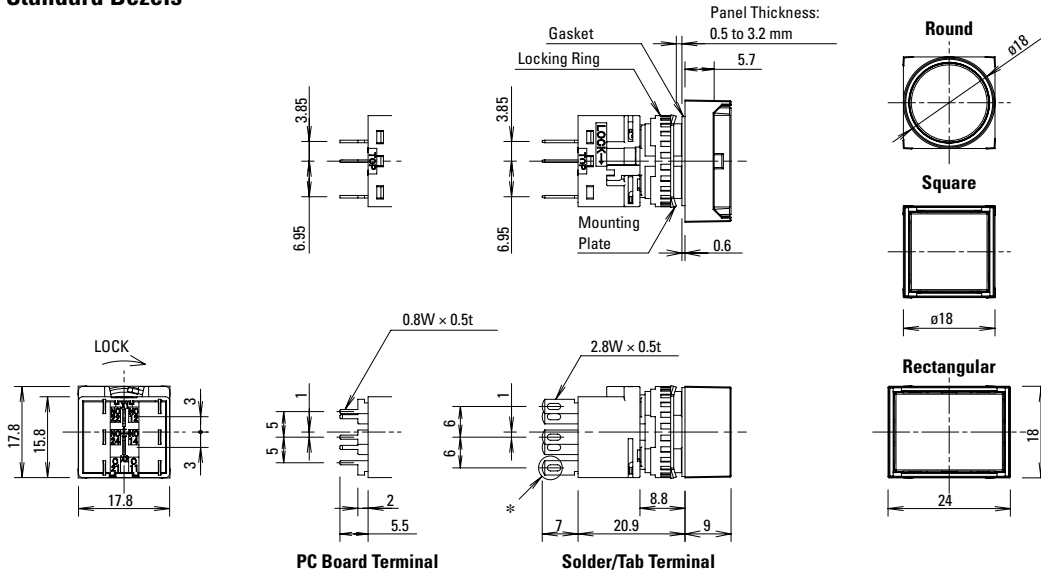

Flush Bezels SPDT/DPDT Contacts

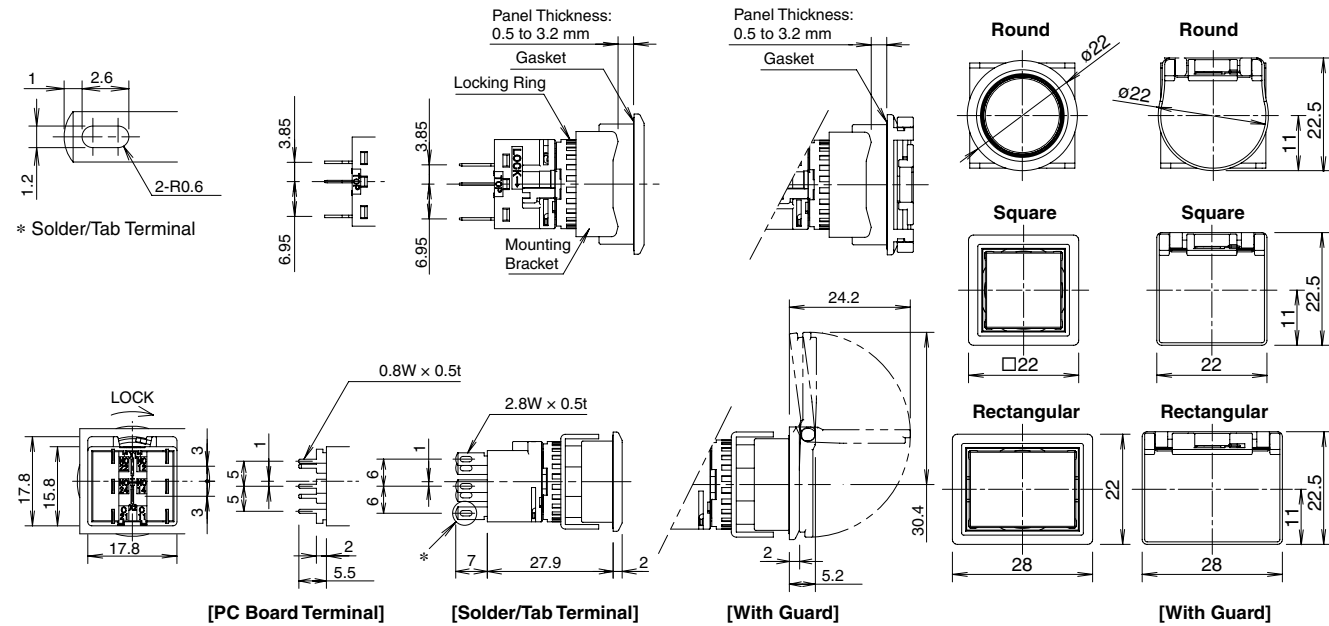

Terminal Arrangement (Bottom View)

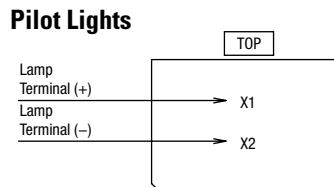
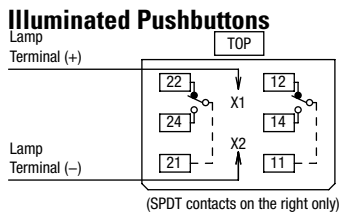

Pilot Lights

Standard Bezels

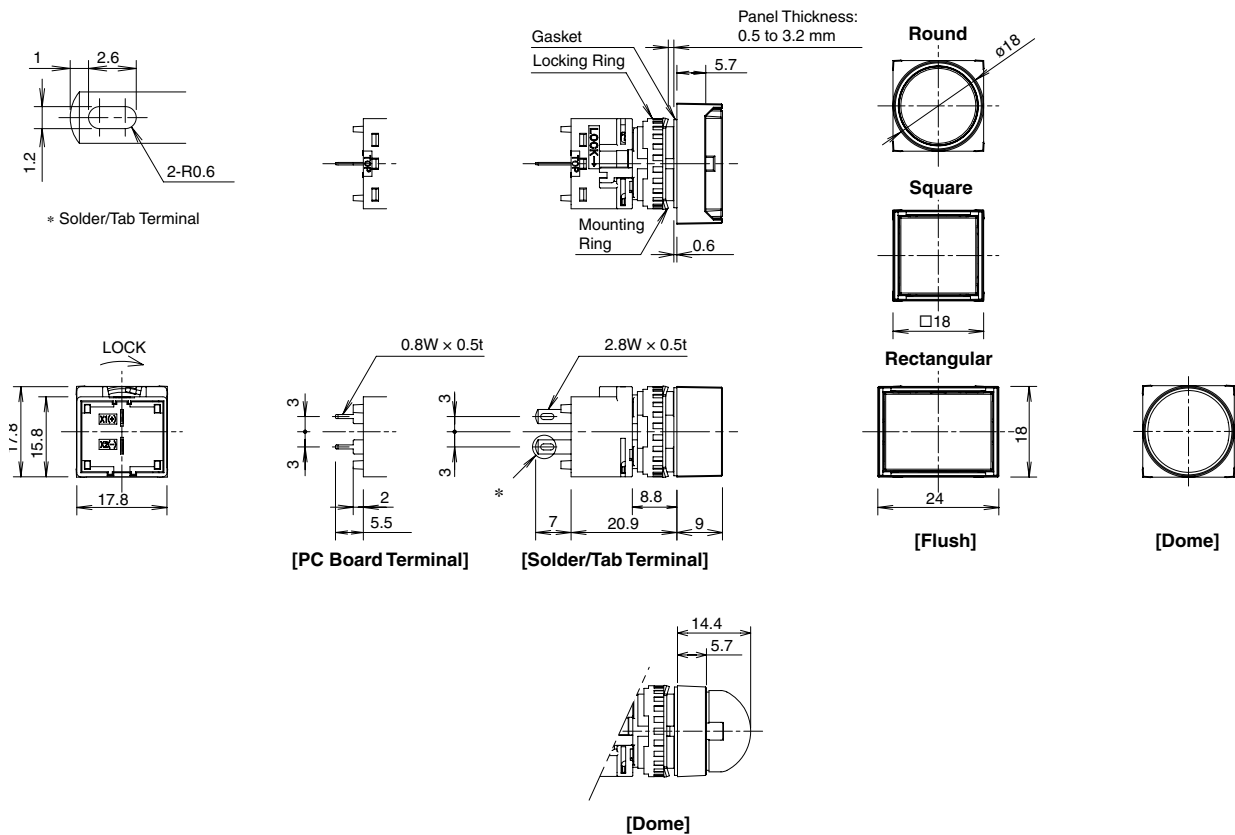

Flush Bezels

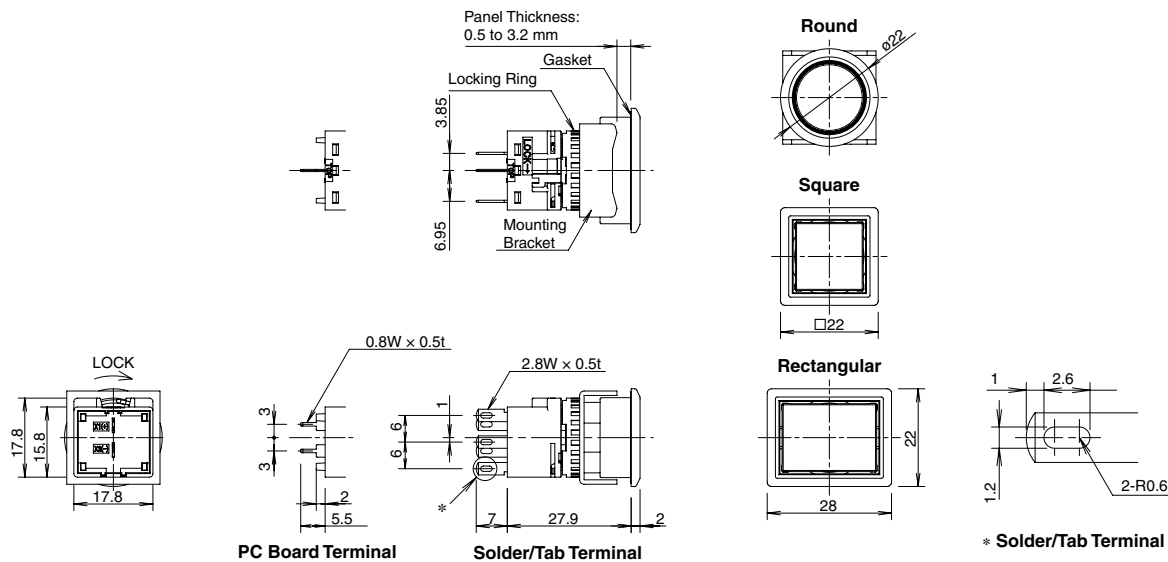

Non-Illuminated Pushbuttons

Standard Bezels

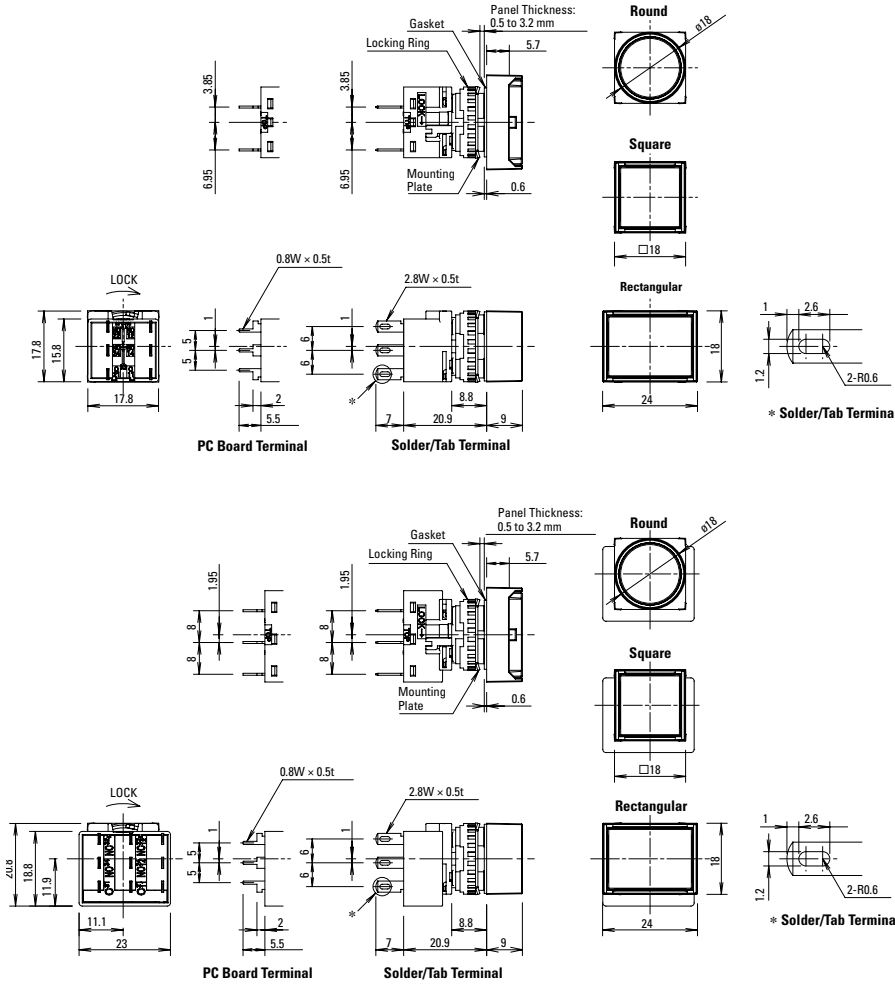

Terminal Arrangement (Bottom View)

SPDT/DPDT Contacts

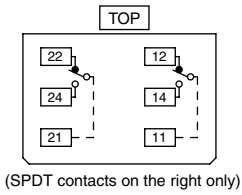

3PDT Contacts

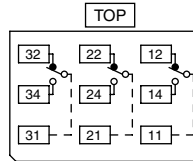

Non-Illuminated Pushbuttons

Flush Bezels

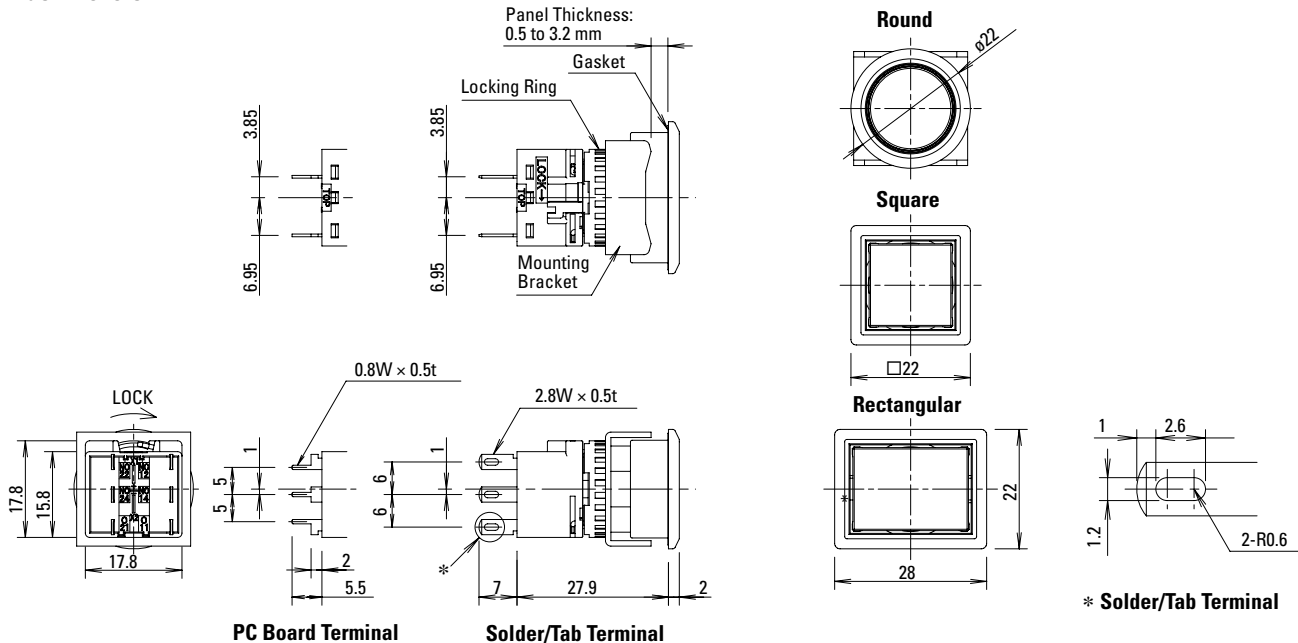

Selector Switches

Standard Bezels

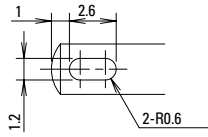

* Solder/Tab Terminal

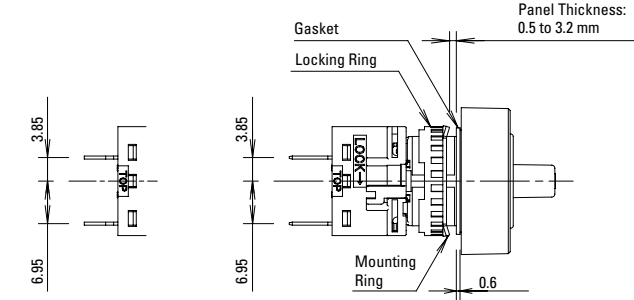

[SPDT/DPDT]

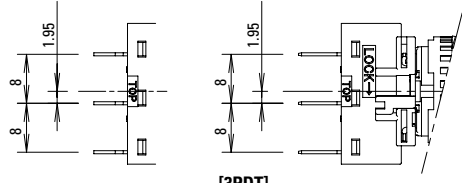

[3PDT]

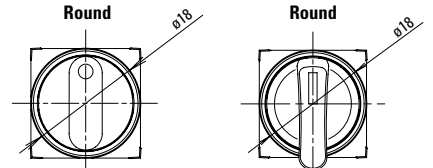

Round

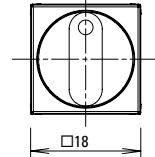

Square

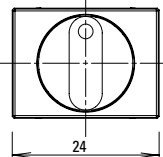

[Knob Operator]

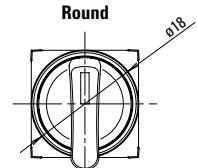

Square

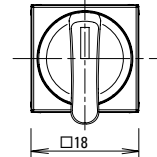

Rectangular

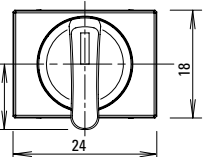

[Lever Operator]

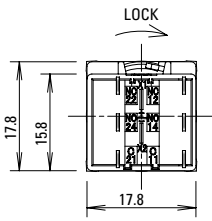

[SPDT/DPDT]

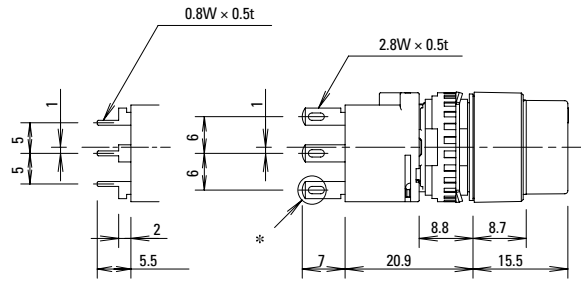

[PC Board Terminal]

[Knob Operator PC Board Terminal]

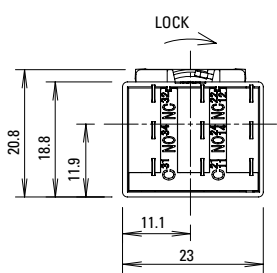

[3PDT]

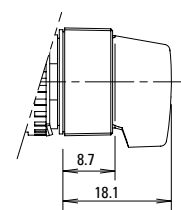

[Lever Operator]

Selector Switches

Flush Bezels

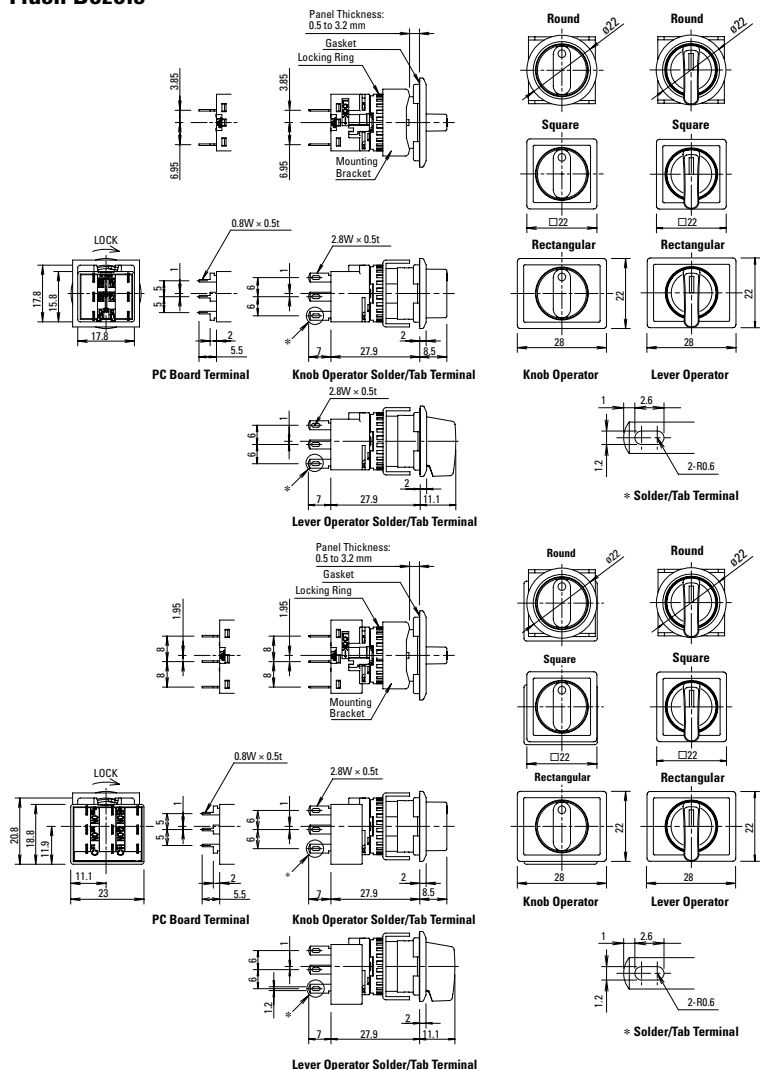

Terminal Arrangement (Bottom View)

SPDT/DPDT Contacts

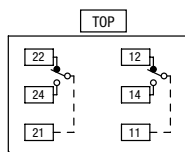

3PDT Contacts

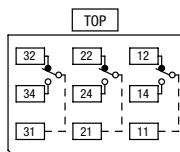

Illuminated Selector Switches

Standard Bezels

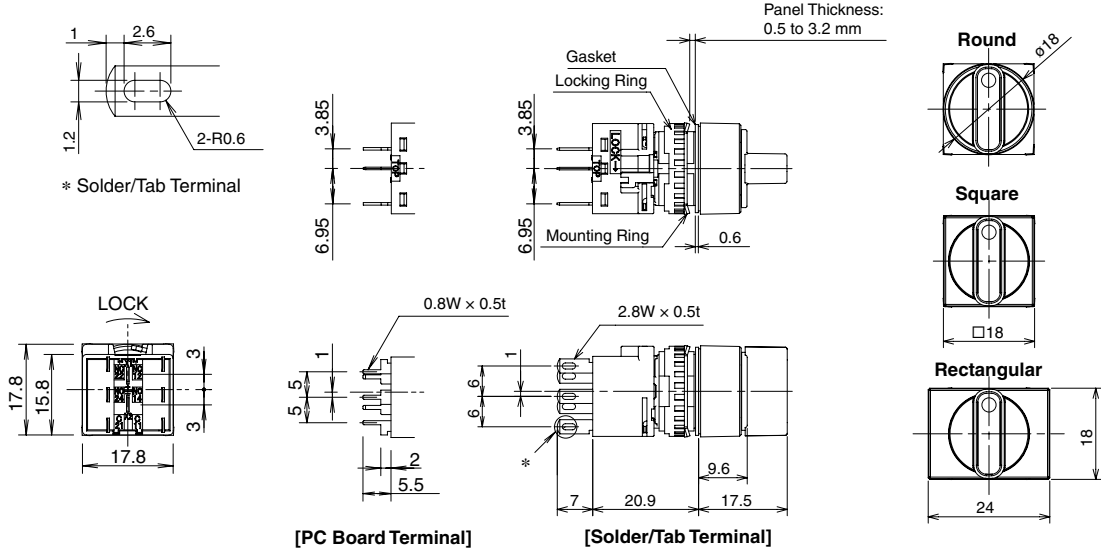

Flush Bezels

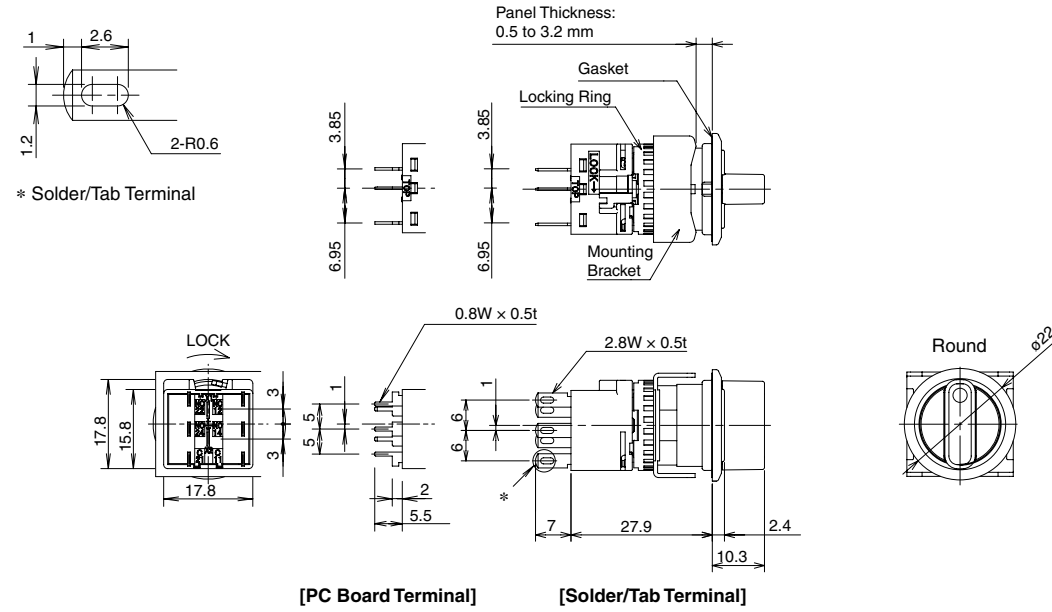

Terminal Arrangement (Bottom View)

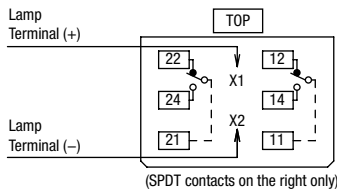

Key Selector Switches

Standard Bezels With Wave Key

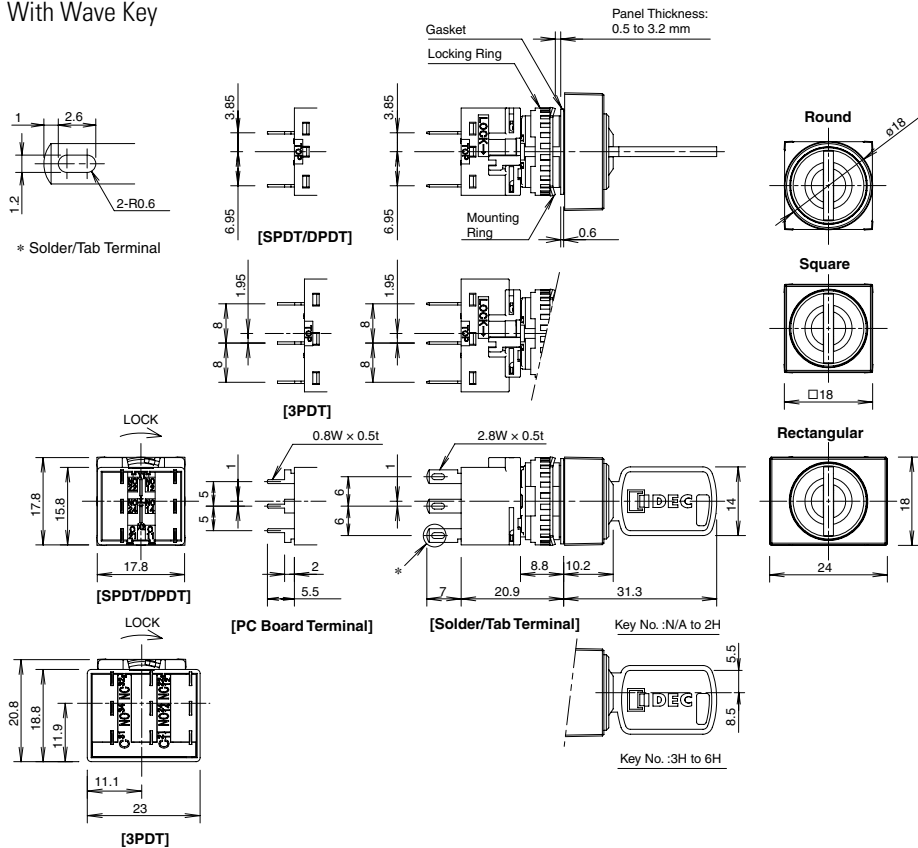

With Standard Key

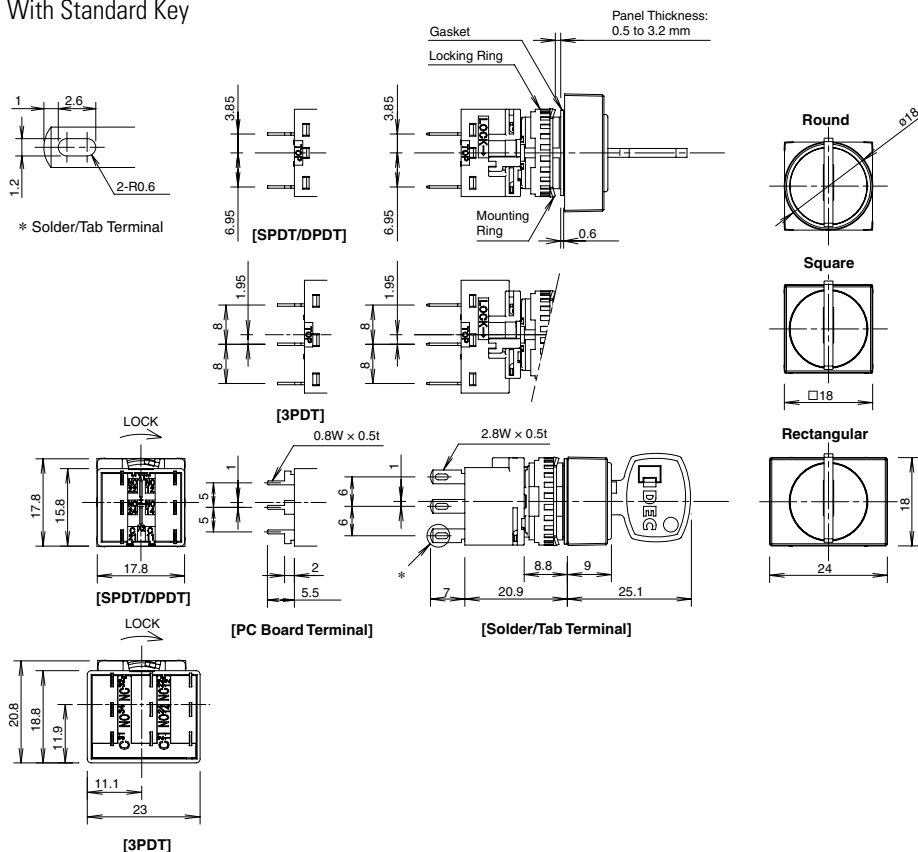

Key Selector Switches

800-262-IDEC (4332) • USA & Canada

Flush Bezels
With Wave Key

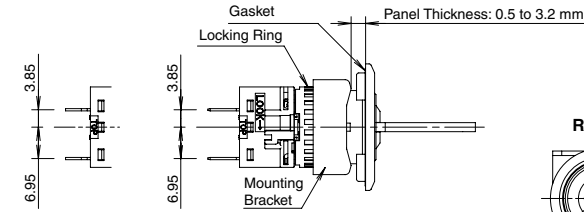
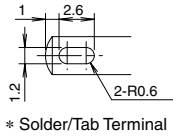

[SPDT/DPDT]

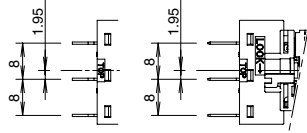

[3PDT]

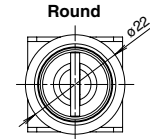

Round

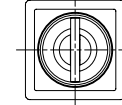

Square

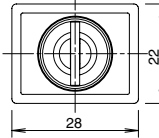

Rectangular

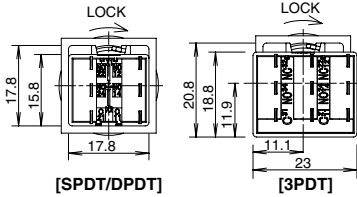

[SPDT/DPDT]

[3PDT]

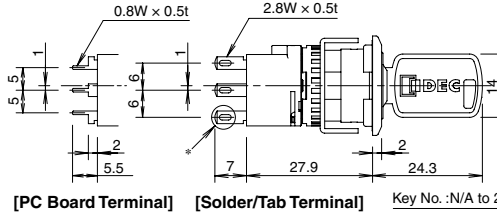

[PC Board Terminal]

[Solder/Tab Terminal]

Key No.: N/A to 2H

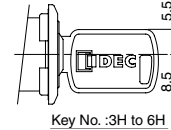

Key No.: 3H to 6H

With Standard Key

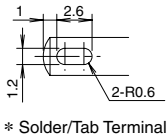

* Solder/Tab Terminal

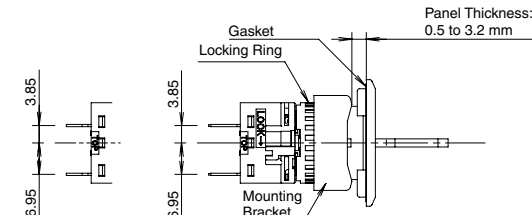

[SPDT/DPDT]

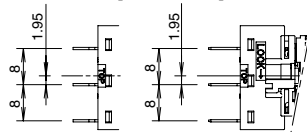

[3PDT]

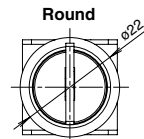

Round

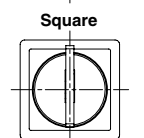

Square

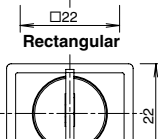

Rectangular

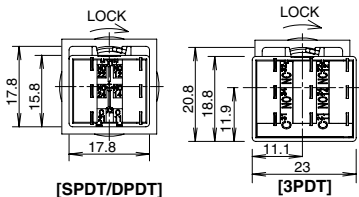

[SPDT/DPDT]

[3PDT]

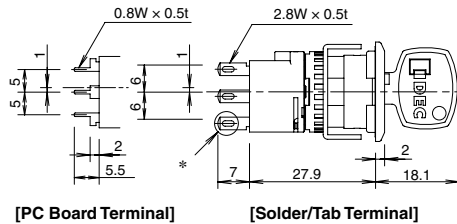

[PC Board Terminal]

[Solder/Tab Terminal]

Terminal Arrangement (Bottom View)

SPDT/DPDT Contacts

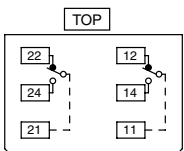

(SPDT contacts on the right only)

3PDT Contacts

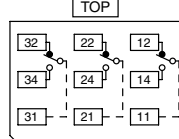

Lever Switches

Panel Thickness: 0.5 to 3.2 mm

Standard Bezels

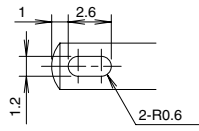

* Solder/Tab Terminal

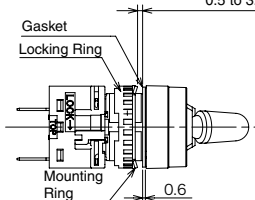
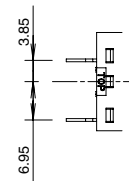

[SPDT/DPDT]

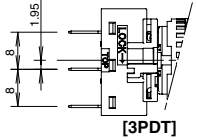
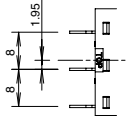

[3PDT]

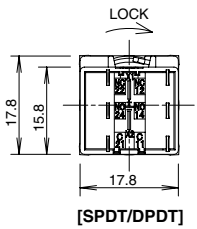

[SPDT/DPDT]

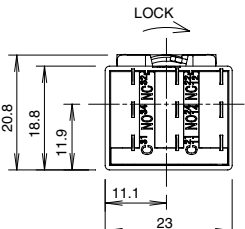

[3PDT]

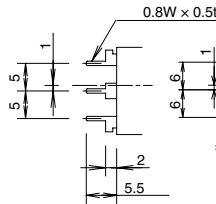

[PC Board Terminal]

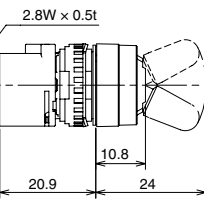

[Solder/Tab Terminal]

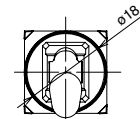

Flush Bezels

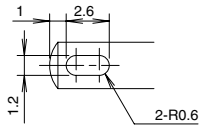

* Solder/Tab Terminal

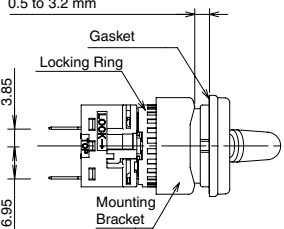
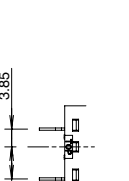

[SPDT/DPDT]

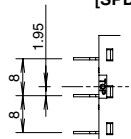

[3PDT]

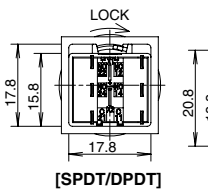

[SPDT/DPDT]

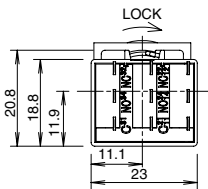

[3PDT]

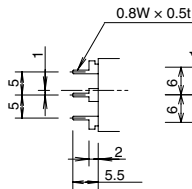

[PC Board Terminal]

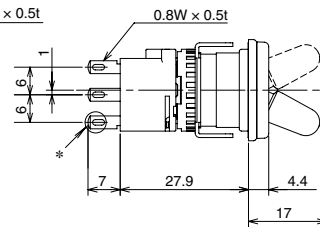

[Solder/Tab Terminal]

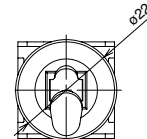

Terminal Arrangement (Bottom View)

SPDT/DPDT Contacts

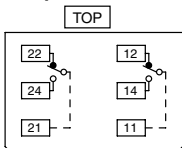

(SPDT contacts on the right only)

3PDT Contacts

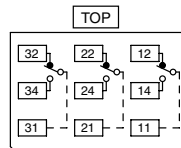

Buzzers

Standard Bezels

IP54

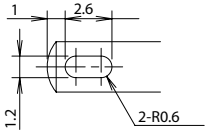

* Solder/Tab Terminal

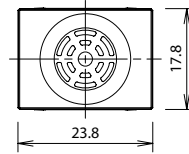
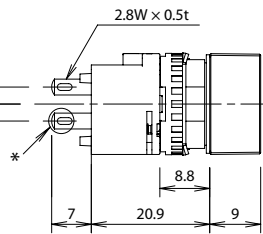
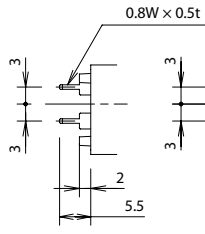
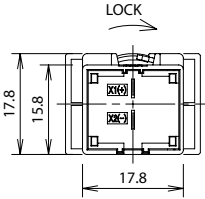
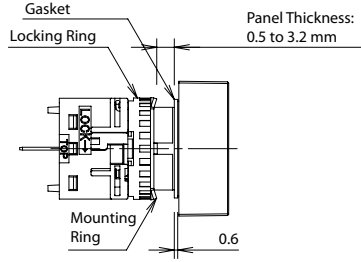

[PC Board Terminal]

[Solder/Tab Terminal]

Terminal Arrangement (Bottom View)

Flush & Standard IP54

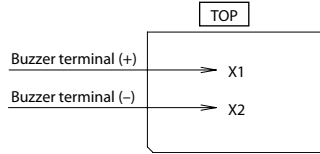

IP40

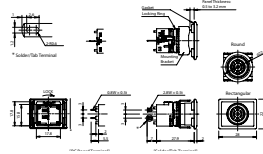

IP40

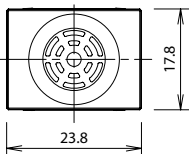
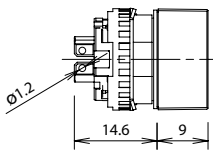
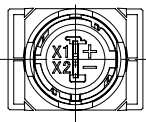
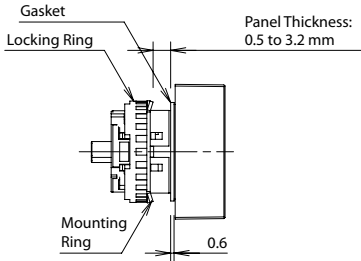

Flush Bezels

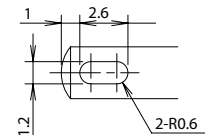



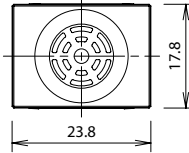
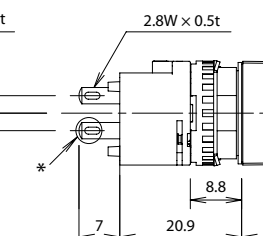
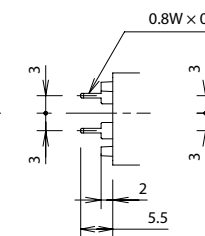
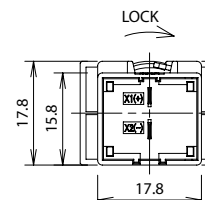
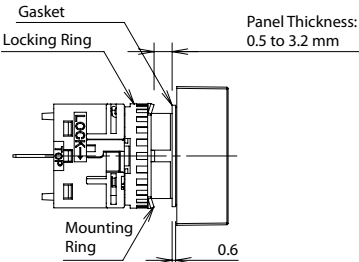



* Solder/Tab Terminal

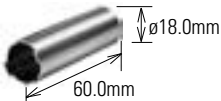
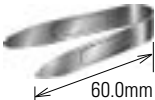
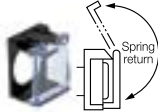

[PC Board Terminal]

[Solder/Tab Terminal]

Accessories

Item	Material	Part Number	Remarks	
Locking Ring Wrench 	Metal: Nickel-plated brass	MT-001	Used to tighten the locking ring when installing the units on to the panel.	
Lens Removal Tool 	Stainless Steel	MT-101	Used to remove the lens or button.	
Switch Guard (180° Spring return) 	For round / square standard units	Guard: Polyacetal Base: Polyarylate	Degree of protection: IP65 Used to protect standard pushbuttons and illuminated pushbuttons from inadvertent operation. See page page 538 for dimensions. With the gasket mounted on the switch, attach the switch guard and mount on the panel. Note: not applicable for flush mounted units. Select operator with built-in switch guard.	
	For rectangular standard units	AL-KH6SP		
Switch Guard for Single Board Mounting 	For rectangular units	Guard: Polyacetal Base: Polyarylate	Degree of protection: IP65 With the gasket mounted on the switch, attach the switch guard and mount on the panel. See page page 538 for dimensions.	
Rubber Boot for Standard Bezels 1  2  3 	1. For round units	Silicon Rubber	Degree of protection: IP65 See page page 537 for dimensions. See page page 540 for mounting.	
	2. For square units			LB9Z-D2
	3. For rectangular units			LB9Z-D3
Mounting Hole Plug 	Metal	Plug: Metal (Zinc diecast) Locking nut: Polyacetal Gasket: Nitrile rubber	Degree of protection: IP65 Tightening torque: 0.1 to 0.29 N•m See page page 537 for dimensions.	
Mounting Hole Plug 	Rubber	Nitrile rubber (black)	Degree of protection: IP65 See page page 537 for dimensions.	

For Standard Bezels

Accessories con't

Item	Material	Part Number	Remarks
Rubber Boot for Flush Bezels			
1 	Silicon Rubber	1. For round units	Degree of protection: IP65 See page page 537 for dimensions. See page page 540 for mounting.
2 		2. For square units	
3 		3. For rectangular units	
For Flush Bezels			
Mounting Hole Plug			
1 	Plug: Polyamide (Black) Gasket: Nitrile rubber Mounting Plate: Stainless Steel	1. For round units	Degree of protection: IP65 Panel thickness: 0.5 to 3.2mm See page page 537 for dimensions.
2 		2. For square units	
3 		3. For rectangular units	
Terminal Cover			
1  2 		1. For SPDT/DPDT contacts	See page page 538 for dimensions.
		2. For 3PDT contacts	

Accessory Dimensions (mm)

Rubber Boot

Standard Bezel

For round units (LB9Z-D1)

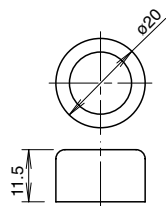

For square units (LB9Z-D2)

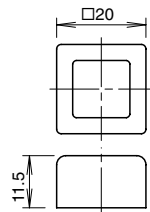

For rectangular units (LB9Z-D3)

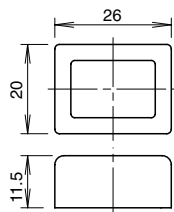

Flush Bezel

For round units (LB9Z-D6)

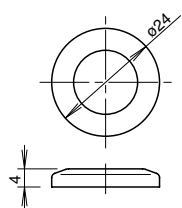

For square units (LB9Z-D7)

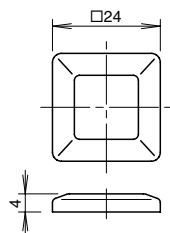

For rectangular units (LB9Z-D8)

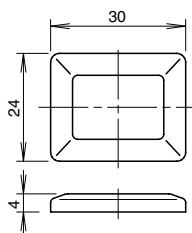

Mounting Hole Plug

Standard Bezels

AL-B6

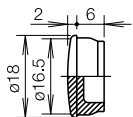

AL-BM6

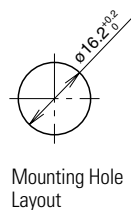
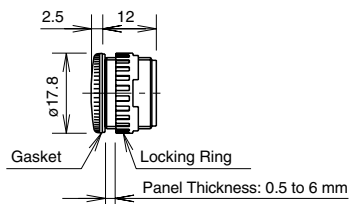

Flush Bezels

For round units (LB9Z-BS6)

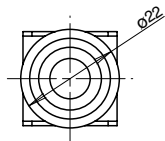

Mounting Hole Layout

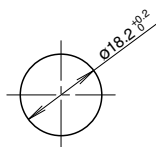

For square units (LB9Z-BS7)

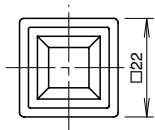

Mounting Hole Layout

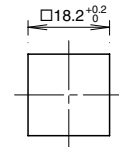

For rectangular units (LB9Z-BS8)

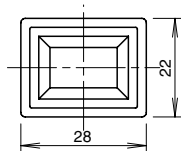

Mounting Hole Layout

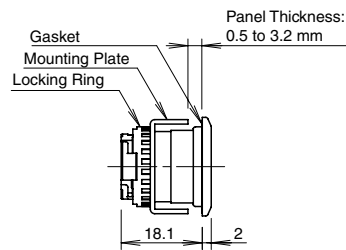
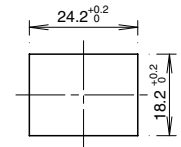

Accessory Dimensions (mm) con't

Terminal Cover

Standard Bezel

For SPDT/DPDT contacts (LB9Z-VL2)

For 3PDT contacts (LB9Z-VL3)

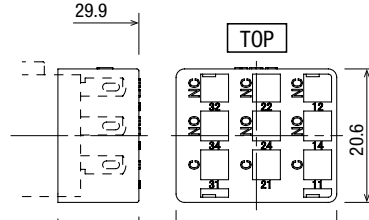
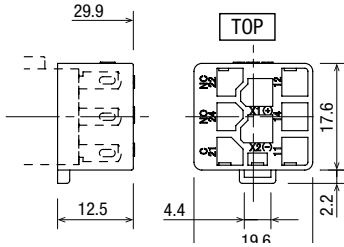

Switch Guard for Standard Bezel Models

For round / square units (AL-K6SP)

For rectangular units (AL-KH6SP)

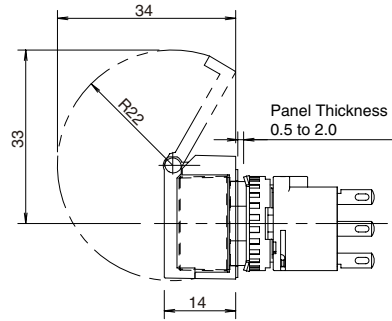
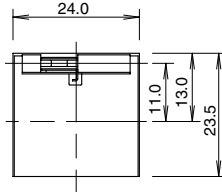
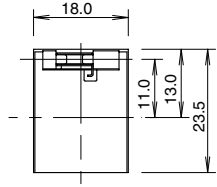

For Single Board Mounting (LA9Z-K3)

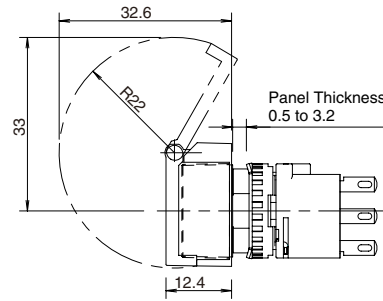
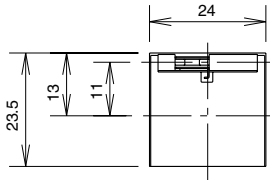

Note: The panel depth is the same for switches with or without switch guards. Both models can be installed on the same PC board.

Standard Key

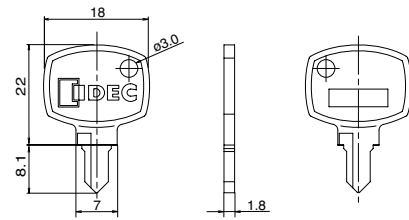

Wave Key

Reversible Wave Key

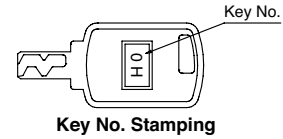
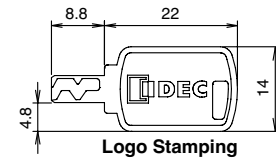

Non-reversible Wave Key

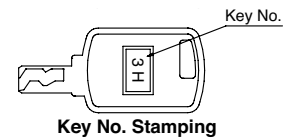
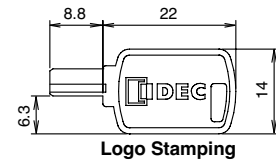

Replacement Parts

Item		Material	Part Number	Remarks
Lens 	For round units	Polyarylate ø15.4 H4mm	AL6M-L②	Specify the color code in place of ② in the part number. A: Amber, C: Clear, G: Green, R: Red, S: Blue, Y: Yellow Note: Use a clear lens for or white (PW) illumination.
	For square units	Polyarylate □15.4, H4mm	AL6Q-L②	
	For rectangular units	Polyarylate W21.4 x H4 x D15.4mm	AL6H-L②	
Button 	For round units	Polyarylate □15.4, H4mm	AB6M-B②	Specify the color code in place of ② in the part number. B: Black, G: Green, R: Red, S: Blue W: White, Y: Yellow
	For square units	Polyarylate □15.4, H4mm	AB6Q-B②	
	For rectangular units	Polyarylate W21.4 x H4 x D15.4	AB6H-B②	
Marking Plate 	For round units	Acrylic ø13.7 H0.8	AL6M-②	Specify the color code in place of ② in the part number. B: Black, W: White
	For square units	Acrylic □13.7, H0.8mm	AL6Q-②	
	For rectangular units	Acrylic W19.7 x H0.8 (0.4) x D13.7mm	AL6H-②	
Locking Ring 	For all units	Polyamide ø17.9, H3.9mm	LB9Z-LNP	
Anti-rotation Ring 	For standard bezel	Metal (Stainless steel) □17.9, t0.6mm	LB9Z-LP1	
Anti-rotation Ring 	For flush bezel	Metal (Stainless steel) W21 x H8.2 x D20.6 t0.8mm	LB9Z-LP6	
Spare Standard Key 	For key selector switches	Nickel-plated Brass	AS6-SK	See page page 538 for dimensions.
Spare Wave key Non-reversible Wave Key  Reversible Wave Key 	For Wave key selector switches	Diecast zinc alloy (nickel plated) W14 x H2 x D30.8mm	LA9Z-SK-⑤	Specify Wave key number in place of ⑤ in the part number. 0H: Standard wave key (reversible) 1H to 2H: Reversible wave key 3H to 6H: Non-reversible wave key See page page 538 for dimensions.

LB Series Replacement LED Unit

Item	Rated Operating Voltage	Part Number	②Color Code	
LED Unit 	DC5V	LB9Z-LED5②	A G PW R S	8. Specify color code in place of the ② in the part number. R: Red, G: Green, A: Amber, S: Blue, PW: White 9. All illuminated LB series contain an LED unit. 10. Use a white (PW) LED unit for yellow (Y) illumination.
	AC/DC12V	LB9Z-LED1②		
	AC/DC24V	LB9Z-LED2②		

Precautions & Instructions  **Safety Precautions**

- Turn off the power to the LB series control units before installation, removal, wiring, maintenance, and inspection. Failure to turn power off may cause electrical shocks or fire hazard.
- To avoid burning your hand, use the lamp holder tool when replacing the lamps.

- For wiring, use wires of a proper size to meet voltage and current requirements. Solder correctly according to the instructions in "Wiring" and "Notes on Terminal Cover." Improper soldering may cause overheating and create a fire hazard. Also, when using tab terminals, use receptacles of appropriate size.

Instructions

Wiring

1. Solder the terminals at 350°C within 3 seconds using a 60W soldering iron. Sn-Ag-Cu type is recommended. When soldering, do not touch the LB series with the soldering iron. Also ensure that no tensile force is applied to the terminals. Do not bend the terminal or apply excessive force to the terminal.
2. Use non-corrosive liquid flux.

Terminal Cover

Solder/tab terminal
Insert the terminal cover into the contact block with the TOP markings on the contact block and the terminal cover in the same direction.

Note: When wiring, insert the lead wires into the terminal cover holes before soldering. After wiring, terminal covers cannot be installed.

Standard Bezel



Flush Bezel

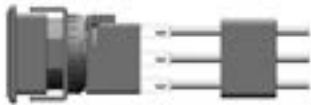

Operating Environment

- Do not use the LB series where corrosive gases exist or under an environment exceeding the operating temperature and humidity ranges. Otherwise, damage such as contact failure or change of the surface color may occur.
- Major parts of the switch are plastic. Scratches or damage may occur when scraped with a sharp object or if excessive load or shock is applied. Note that this may cause operation and appearance failure of the operator and bezel.
- Application of detergent, cutting oil, or special chemicals to the switch may result in operation and/or appearance failure such as a change in surface color.

Handling

Contacts (micro switch)
When using NC (normally closed) and NO (normally open) contacts of the same microswitch, avoid connections of different voltages, or connections of different types of power supplies. Failure to observe this instruction may cause a short-circuit.

Removing and Installing the Contact Block

3. Turn the locking lever on the contact block in the direction opposite to the arrow on the housing. Then the contact block can be removed.
4. Insert the contact block with the TOP markings on the contact block and the operator placed in the same direction. Then lock the units, turning the locking lever in the direction of the arrow.

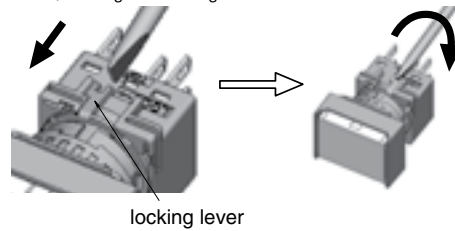

Panel Mounting

Remove the contact block from the operator. Insert the operator into the panel cut-out from the front, then install the contact block to the operator.

Standard Bezel

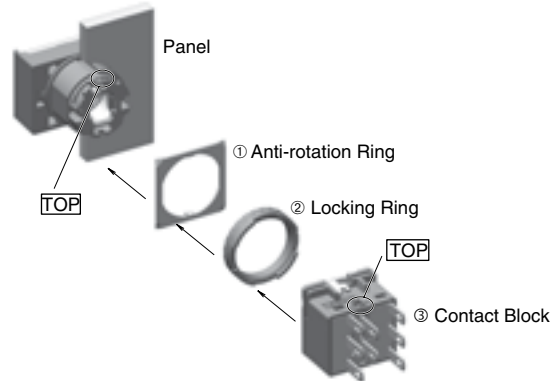

Flush Bezel

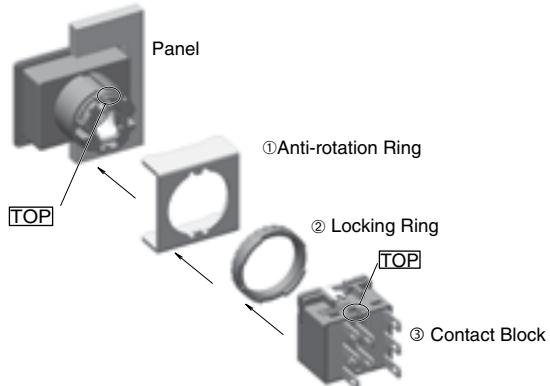

Notes on Mounting

Use the optional ring wrench (MT-001) to mount the operator onto the panel. Tightening torque should not exceed 0.7 N·m. Do not use pliers. Excessive tightening will damage the locking ring.

A6 Series — Miniature Switches and Pilot Devices: 16mm

Key features:

- 16mm (5/8") mounting hole
- LED illumination
- Compact design saves space
- Momentary, Maintained, Selectors, and E-Stops
- Gold-clad Silver contacts for reliable low level switching
- Snap action contacts
- IP40 (dustproof) or IP65 (oiltight) versions



Specifications	Degree of Protection		IP40: Dustproof IP65 Watertight/Oiltight			
	Contact Configuration		SPDT, DPDT			
	Maximum Voltage		250V AC/DC			
	Thermal Current		3A			
	Minimum Applicable Load		5V AC/DC, 1mA			
	Contact Material		Gold-clad silver			
	Terminal Style		.110" Solder/ Quick Connect			
	Operating Temperature		-25° to +55°C (no freezing)			
	Operating Humidity		45 to 85% RH			
	Contact Resistance		50mΩ maximum (initial value)			
	Insulation Resistance		100MΩ minimum (500V DC megger)			
	Vibration Resistance		10 to 55Hz, amplitude 1.5mm p-p			
	Shock Resistance		Damage limits: 500m/sec ² (approx. 50G) Operating extremes: 200m/sec ² (approx. 20G)			
	Electrical Life		100,000 operations minimum (at full rated load)			
Contact Ratings	Operating Voltage		24V	120V	240V	
	AC (50/60Hz)	Resistive	—	1.0A	0.5A	
		Inductive	—	0.7A	0.5A	
	DC	Resistive	1.0A	0.2A	—	
Inductive		0.7A	0.1A	—		
LED Lamp Ratings	Rated Voltage/Current		5V DC ±5%	6V AC/DC (±10%)	12V AC/DC (±10%)	24V AC/DC (±10%)
			8mA	AC: A, R, W, Y: 8mA G, S: 7mA DC: A, R, W, Y: 6mA G, S: 5mA	AC: 9mA DC: 8mA	AC: 9mA DC: 8mA

1. AC Inductive Load, PF = 0.6 – 0.7; DC Inductive Load, L/R = 7ms.
2. LED lamp contains a built-in current limiting resistor and a protection diode.
3. LED's don't "burn out." Luminance is reduced to 50% of initial intensity after being lit for 50,000 hours continuously.

Switches & Pilot Devices

Signaling Lights

Relays & Sockets

Timers

Contactors

Terminal Blocks

Circuit Breakers

AB6 Non-Illuminated Pushbuttons (Assembled)

Non-Illuminated Pushbuttons

Style	Contact	Part Number			
		Momentary		Maintained (Latching)	
		Dustproof (IP40)	Oiltight (IP65)	Dustproof (IP40)	Oiltight (IP65)
Round 18mm 	SPDT DPDT	AB6M-M1-① AB6M-M2-①	AB6M-M1P-① AB6M-M2P-①	AB6M-A1-① AB6M-A2-①	AB6M-A1P-① AB6M-A2P-①
Square 18mm 	SPDT DPDT	AB6Q-M1-① AB6Q-M2-①	AB6Q-M1P-① AB6Q-M2P-①	AB6Q-A1-① AB6Q-A2-①	AB6Q-A1P-① AB6Q-A2P-①
Rectangular 18mm x 24mm 	SPDT DPDT	AB6H-M1-① AB6H-M2-①	AB6H-M1P-① AB6H-M2P-①	AB6H-A1-j AB6H-A2-j	AB6H-A1P-① AB6H-A2P-①
Round 23.5mm 	SPDT DPDT	-	AB6M-M1P-M② AB6M-M2P-M②	-	AB6M-A1P-M① AB6M-A2P-M①
Square 23.5mm 	SPDT DPDT	-	AB6Q-M1P-Q① AB6Q-M2P-Q①	-	AB6Q-A1P-Q① AB6Q-A2P-Q①
Rectangular 17.5 X 23.5mm 	SPDT DPDT	-	AB6Q-M1P-H① AB6Q-M2P-H①	-	AB6Q-A1P-H① AB6Q-A2P-H①

① Button Color Code

Color	Code
Black	B
Green	G
Red	R
Blue	S
White	W
Yellow	Y





1. In place of ① specify Button Color Code from the table at right.
2. To order as sub-assembled, see page 459.
3. For accessories, see page 466.
4. For dimensions, see page 468.

AB6 Non-Illuminated Pushbuttons (Sub-Assembled)



Operators

Style	Contact	Operator	Part Number		
			Round	Square	Rectangular
Non-Illuminated Pushbuttons 	SPDT	Momentary	AB6M-M100	AB6Q-M100	AB6H-M100
		Maintained	AB6M-A100	AB6Q-A100	AB6H-A100
	DPDT	Momentary	AB6M-M200	AB6Q-M200	AB6H-M200
		Maintained	AB6M-A200	AB6Q-A200	AB6H-A200

 Oversize rectangular button uses square operator.

Buttons

Description	Part Number	
	Button	
	Dustproof (IP40)	Oiltight (IP65)
Round 	AB6M-BK1-j	AB6M-BK2-j
Square 	AB6Q-BK1-j	AB6Q-BK2-j
Rectangular 	AB6H-BK1-j	AB6H-BK2-j
Round Oversize 	—	AB6M-BK2-Mj
Square Oversize 	—	AB6Q-BK2-Qj
Rectangular Oversize 	—	AB6Q-BK2-Hj

① Button Color Code

Color	Code
Black	B
Green	G
Red	R
Blue	S
White	W
Yellow	Y

-  1. In place of j, specify Button Color Code from table.
- 2. Buttons which are rated IP65 include a waterproof rubber gasket.
- 3. For accessories, see page 466.

AL6 Illuminated Pushbuttons (Assembled)

LED Illuminated Pushbuttons

Description	Style	Contact	Part Numbers			
			Momentary		Maintained (Latching)	
			Dustproof (IP40)	Oiltight (IP65)	Dustproof (IP40)	Oiltight (IP65)
Standard Lens	Round (18mm lens) 	SPDT DPDT	AL6M-M1③-② AL6M-M2③-②	AL6M-M1③P-② AL6M-M2③P-②	AL6M-A1③-② AL6M-A2③-②	AL6M-A1③P-② AL6M-A2③P-②
	Square (18mm lens) 	SPDT DPDT	AL6Q-M1③-② AL6Q-M2③-②	AL6Q-M1③P-② AL6Q-M2③P-②	AL6Q-A1③-② AL6Q-A2③-②	AL6Q-A1③P-② AL6Q-A2③P-②
	Rectangular (18mm x 24mm lens) 	SPDT DPDT	AL6H-M1①-② AL6H-M2①-②	AL6H-M1IP-② AL6H-M2IP-②	AL6H-A1①-② AL6H-A2①-②	AL6H-A1IP-② AL6H-A2IP-②
Oversize Lens	Round (24mm lens) 	SPDT DPDT	-	AL6M-M1③P-M② AL6M-M2③P-M②	-	AL6M-A1③P-M② AL6M-A2③P-M②
	Square (24mm lens) 	SPDT DPDT	-	AL6Q-M1③P-Q② AL6Q-M2③P-Q②	-	AL6Q-A1③P-Q② AL6Q-A2③P-Q②
	Rectangular (18mm x 24mm lens) 	SPDT DPDT	-	AL6Q-M1③P-H② AL6Q-M2③P-H②	-	AL6Q-A1③P-H② AL6Q-A2③P-H②

- 1. In place of ②, specify Lens/LED Color Code from table below.
- 2. In place of ③, specify Voltage Code from table below.
- 3. Lamps also available in 5V DC, 6V AC/DC or 12 V AC/DC, change "4" using voltage/lamp codes (ie AL6M-M13-k uses 12V AC/DC LED).
- 4. LED lamp is included in unit and contains a current-limiting resistor and a protection diode. (External resistor not required.)
- 5. To order as sub-assembled, see page.
- 6. For accessories, see page.
- 7. For dimensions, see page.
- 8. Light independent of switch position.

② Lens/LED Color Code

Color	Code
Amber	A
Green	G
Red	R
Blue	S
Warm White	W
Cool White	JW
Yellow	Y

③ Voltage Code

Voltage	Code
5V DC	1
6V AC/DC	2
12V AC/DC	3
24V AC/DC	4

AL6 Illuminated Pushbuttons (Sub-Assembled)













Operators

Style	Contact	Operator	Part Number		
			Round	Square	Rectangular
AL6 Illuminated Pushbuttons 	SPDT	Momentary	AL6M-M100	AL6Q-M100	AL6H-M100
		Maintained	AL6M-A100	AL6Q-A100	AL6H-A100
	DPDT	Momentary	AL6M-M200	AL6Q-M200	AL6H-M200
		Maintained	AL6M-A200	AL6Q-A200	AL6H-A200



Oversize rectangular button uses square operator.

Lenses

Unit	Degree of Protection	Dustproof (IP40)	Part Number	
			Standard	Oiltight (IP65)
				Standard
Round		AL6M-LK1-k 	AL6M-LK2-⊙ 	AL6M-LK2-M k 
			AL6Q-LK2-k 	AL6Q-LK2-Q k 
Square		AL6Q-LK1-k 	AL6H-LK2-k 	AL6Q-LK2-H k 
			AL6H-LK1-k 	AL6Q-LK2-k 



- In place of ⊙, specify Lens Color Code from table below.
- Lenses which are rated IP65 include a waterproof rubber gasket.
- For accessories, see page.

Ⓜ Lens/LED Color Code

Color	Code
Amber	A
Green	G
Red	R
Blue	S
Warm White	W
Cool White	JW
Yellow	Y

LED Lamps

Appearance	Rated Voltage	Part Number
	5V DC	LATD-5 ⊙
	6V AC/DC	LATD-6 ⊙
	12V AC/DC	LATD-1 ⊙
	24V AC/DC	LATD-2 ⊙



- In place of ⊙, specify LED Color Code from table at left.

AL6 Pilot Lights (Assembled)

LED Pilot Lights

Description	Part Number	
	Dustproof (IP40)	Oiltight (IP65)
Round (18mm Lens) 	AL6M-P③-②	AL6M-P③P-②
Square (18mm Lens) 	AL6Q-P③-②	AL6Q-P③P-②
Rectangular (18mm x 24mm Lens) 	AL6H-P③-②	AL6H-P③P-②

- 1. In place of ②, specify Lens Color Code from table below.
- 2. In place of ③, specify Voltage Code from table below.
- 3. LEDs also available in 5V DC, 6V AC/DC or 12 V AC/DC, change "4" using voltage codes (ie AL6M-P3-② uses 12V AC/DC LED).
- 4. LED is included and contains built-in current limiting resistor and reverse polarity protection diode. (no external resistor required)
- 5. To order sub-assembled, see page.
- 6. For accessories, see page.
- 7. For dimensions, see page.
- 8. For one piece pilot lights and/or dome lens pilot lights, see AP series miniature pilot lights.

② Lens/LED Color Code

Color	Code
Amber	A
Green	G
Red	R
Blue	S
Warm White	W
Cool White	JW
Yellow	Y

③ Voltage Code

Voltage	Code
5V DC	1
6V AC/DC	2
12V AC/DC	3
24V AC/DC	4

AL6 Pilot Lights (Sub-Assembled)



Operators

Style	Part Number		
	Round	Square	Rectangular
AL6 Pilot Lights 	AL6M-P00	AL6Q-P00	AL6H-P00

Lenses

Degree of Protection	Part Number	
	Dustproof IP40	Oiltight IP65
Round	AL6M-LK1-Ⓢ 	AL6M-LK3-Ⓢ 
Square	AL6Q-LK1-Ⓢ 	AL6Q-LK3-Ⓢ 
Rectangular	AL6H-LK1-Ⓢ 	AL6H-LK3-Ⓢ 

- 1. In place of Ⓢ, specify Lens Color Code from table below.
- 2. Lenses which are rated IP65 include a waterproof rubber gasket.
- 3. For accessories, see page.

kLens/LED Color Code

Color	Code
Amber	A
Green	G
Red	R
Blue	S
Warm White	W
Cool White	JW
Yellow	Y

LED Lamps

Appearance	Rated Voltage	Part Number
	5V DC	LATD-5 Ⓢ
	6V AC/DC	LATD-6 Ⓢ
	12V AC/DC	LATD-1 Ⓢ
	24V AC/DC	LATD-2 Ⓢ

- 1. In place of Ⓢ, specify LED Color Code from table at left.

Switches & Pilot Devices

Signaling Lights

Relays & Sockets

Timers

























Contactors

Terminal Blocks

Circuit Breakers



AS6 Selector and Keylock Switches

AS6 Selector Switches and Keylock Switches (2 & 3 Position)

Style	Function	Knob	Knob	Key
Round Selector 	2-Position 90° Maintained		AS6M-2Y2P	AS6M-2KT2PⓈ
	2-Position 90° Spring Return Right		AS6M-21Y2P	AS6M-21KT2PB
Round Keylock 	3-Position 45° Maintained		AS6M-3Y2P	AS6M-3KT2PⓈ
	3-Position 45° Spring Return Right → Center		AS6M-31Y2P	AS6M-31KT2PⓈ
	3-Position 45° Spring Return Left → Center		AS6M-32Y2P	AS6M-32KT2PⓈ
	3-Position 45° 2-Way Return → Center		AS6M-33Y2P	AS6M-33KT2PD
	3-Position 45° 2-Way Return → Center		AS6M-33Y2P	AS6M-33KT2PD
Square Selector 	2-Position 90° Maintained		AS6Q-2Y2P	AS6Q-2KT2PⓈ
	2-Position 90° Spring Return to Right		AS6Q-21Y2P	AS6Q-21KT2PB
Square Keylock 	3-Position 45° Maintained		AS6Q-3Y2P	AS6Q-3KT2PⓈ
	3-Position 45° Spring Return Right → Center		AS6Q-31Y2P	AS6Q-31KT2PⓈ
	3-Position 45° Spring Return Left → Center		AS6Q-32Y2P	AS6Q-32KT2PⓈ
	3-Position 45° 2-Way Return → Center		AS6Q-33Y2P	AS6Q-33KT2PD
Rectangular Selector 	2-Position 90° Maintained		AS6H-2Y2P	AS6H-2KT2PⓈ
	2-Position 90° Spring Return Right		AS6H-21Y2P	AS6H-21KT2PB
Rectangular Keylock 	3-Position 45° Maintained		AS6H-3Y2P	AS6H-3KT2PⓈ
	3-Position 45° Spring Return Right → Center		AS6H-31Y2P	AS6H-31KT2PⓈ
	3-Position 45° Spring Return Left → Center		AS6H-32Y2P	AS6H-32KT2PⓈ
	3-Position 45° 2-Way Return → Center		AS6H-33Y2P	AS6H-33KT2PD

Contact Operations

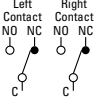
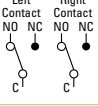
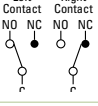
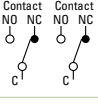
(for all selectors)

Contents	Operator Position & Contact Operation	
2-pos. (DPDT)	Left	
	Right	
3-pos. (DPDT)	Left	
	Center	
	Right	

Key Retention Codes

Code	Description
A	Key not retained in any position (removable in all positions)
B	Key retained in right position only
C	Key retained in left position only
D	Key retained in left and right (3 position only)
E	Key retained in center only (3 position only)
G	Key retained right and center (3 position only)
H	Key retained left and center (3 position only)

 Key cannot be removed in a spring return position.

-  All models are IP65 and DPDT.
- In place of Ⓢ, specify Key Retention Code. See table on right.
- Available as assembled units only.
- For accessories, see page 466.
- For dimensions, see page 468.

Switch Engraving Order Form – A6 Series

Copy this order form and use it to specify Letter Height, Maximum Number of Lines and Text to be engraved.

To insure engraving accuracy, fax it to your IDEC representative or Distributor.

Your Company: _____ Telephone: _____
 Name: _____ Fax: _____
 Address: _____ Email: _____
 PO: _____ Part Number to be Engraved: _____

Please check one of the boxes below to indicate your choice of engraving options:

Rectangular Switch

	# of Lines	Letter Height	Max. Characters Per Line
<input type="checkbox"/>	1	5/32	6
<input type="checkbox"/>	2	5/32	6
<input type="checkbox"/>		1/8	6
<input type="checkbox"/>	3	1/8	6
<input type="checkbox"/>	4	N/A	

Square Switch

	# of Lines	Letter Height	Max. Characters Per Line
<input type="checkbox"/>	1	5/32	5
<input type="checkbox"/>	2	5/32	5
<input type="checkbox"/>		1/8	6
<input type="checkbox"/>	3	1/8	6
<input type="checkbox"/>	4	N/A	

Round Switch

	# of Lines	Letter Height	Max. Characters Per Line
<input type="checkbox"/>	1	5/32	3
<input type="checkbox"/>		1/8	3
<input type="checkbox"/>	2	5/32	Custom*
<input type="checkbox"/>	3	1/8	Custom*
<input type="checkbox"/>	4	3/32	Custom*

*Engraving is possible, but character size will be smaller than standard sizes.



1. Engraving is done on the button itself for non-illuminated pushbuttons and on marking plate for illuminated pushbuttons and pilot lights.
2. Please enter text exactly how you want it engraved, take care to emphasize capital or small letters.

Enter text to be engraved

:
 Line 1: _____
 Line 2: _____
 Line 3: _____
 Line 4: _____

Sample Letter Sizes

1/8 Letters: **OPEN**

5/32 Letters: **OPEN**







For IDEC Internal Use Only:

Work Order #: _____

Accessories

Appearance		Description	Used With	Part Number
Locking Ring Wrench		Made of metal. Used for tightening plastic locking ring during installation. Tightening torque should not exceed 3kgf-cm	Ø 5/8" (16mm) units	MT-001
			Ø 31/64" (12mm) AP2M units	MT-002
			Ø 13/32" (10mm) AP1M units	MT-003
Lens Removal Tool		Made of metal. Used for removing lens or button from the housing	All pushbuttons and pilot lights	MT-101
Lamp Holder Tool		Made of rubber. Used for removing and replacing LED lamps in illuminated units	All illuminated pushbuttons and pilot lights	OR-77
Switch Guard		Prevents inadvertent switch operation. IP40 dust-tight. 90 degrees opening maintained	Round/Square	AL-K6
			Rectangular	AL-KH6
			Prevents inadvertent switch operation. IP65 oiltight 180 degrees opening, spring return	Round/Square
			Rectangular	AL-KH6SP
Terminal Cover		Made of translucent nylon. Fits over and shields the terminals	All 5/8" (16mm) units	AL-V6
Dust Cover		Fits over the lens or button to provide extra protection from dust (not applicable for oversize lenses or buttons).	All round units	AL-D6
			All square units	AL-DQ6
			All rectangular units	AL-DH6
Adaptor Socket		Plug-on terminal adaptor with solder terminals		AL-C6
		Plug-on terminal adaptor with PCB terminals	All 5/8" (16mm) units	AL-C6V
Mounting Hole Plug		Fills unused panel cutouts. Made of nitrile rubber. Push-in installation from front of panel. IP65 (oiltight).	Rubber	AL-B6
		Fills unused panel cutouts. Made of aluminum. Screw-on locking ring from inside of panel. IP65 (oiltight).	Aluminum	AL-BM6
		Round Mounting Hole Plug	Plastic (Applicable for flush mount switches only)	LA9Z-BS6
		Square Mounting Hole Plug		LA9Z-BS7
		Rectangular Mounting Hole Plug		LA9Z-BS8
Replacement LED Lamps		LED with built in current limiting resistor (with all illuminated assemblies).	5V DC	LATD-5 ☉
			6V AC/DC	LATD-6 ☉
			12V AC/DC	LATD-1 ☉
			24V AC/DC	LATD-2 ☉
Replacement Locking Ring		Fastens operators to panel (included with all operators).	All switches & pilot lights	HA9Z-LN
Anti-Rotation Ring		Prevents rotation of switches in panel (included with all operators).	All switches & pilot lights	AL6-LP
Replacement Engraving Inserts		Engraving plates to allow legends underneath translucent lenses (included with all lenses).	Round standard	AL6M-W
			Square standard	AL6Q-W
			Rectangular standard	AL6H-W
			Round oversize	AL6M-MW
			Square/rectangular oversize	AL6Q-QW
Replacement Keys		Pair of keys (#132). All key switches use same standard key.	All key selectors	AS6-SK

1. In place of ☉ specify color code. A=Amber, G=Green, Y=Yellow, R=Red, S=Blue, W=Warm White, JW=Cool White.
 2. LEDs include built-in current limiting resistor and reverse polarity protection diode.

Appearance		Description	Used With	Part Number
Flush Bezel		ø24mm round, metal (aluminum color), panel cut-out ø20.2mm	Pushbuttons, pilot lights, illuminated pushbutton, selector switches, key selector switches and illuminated selector switches.	LA9Z-SM61
		ø24mm round, plastic (black), square panel cut-out ø20.2mm		LA9Z-S61B
		24mm square, plastic (black), panel cut-out 20.2 x 20.2mm	A6 Switch +	LA9Z-S71B
		24 x 30mm rectangular, plastic (black), rectangular panel cut-out ø20.2 x 26.2mm	Flush Bezel =	LA9Z-S81B
Switch Guard w/ Flush Bezel (spring return)		Rectangular, plastic (black)	 Flush Switch	LA9Z-KS8

Schematics — A Series: 5/8" (16mm)

Terminal Arrangement (Top View)

Illuminated Pushbuttons

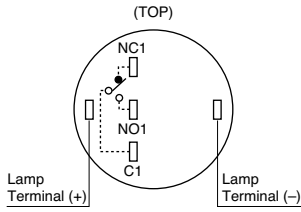

SPDT Contact (Single-pole/Double Throw)

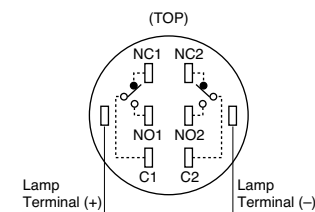

DPDT Contact (Double-pole/Double Throw)

Non-illuminated Pushbuttons and Selector Switches

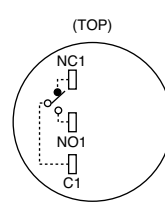

SPDT Contact (Single-pole/Double Throw)

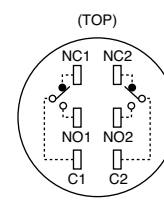



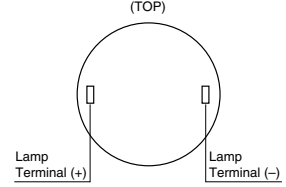

DPDT Contact (Double-pole/Double Throw)

Pilot Lights

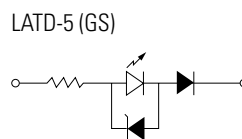
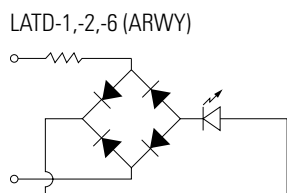
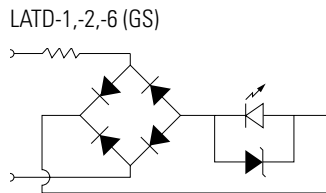

IDEC's Superbright LED Internal Circuits



-  LED Chip
-  Protective Diode
-  Zener Diode

Switches & Pilot Devices

Signaling Lights

Relays & Sockets

Timers

Contactors

Terminal Blocks

Circuit Breakers

Dimensions (mm)

Pushbuttons, Ø 5/8" (16mm)

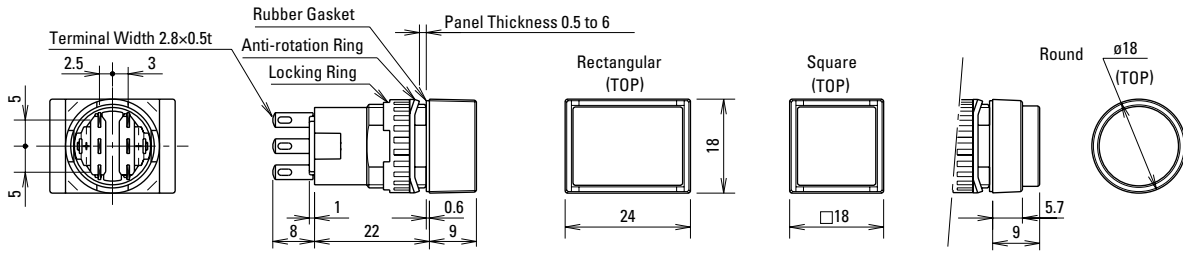

Overize Lens

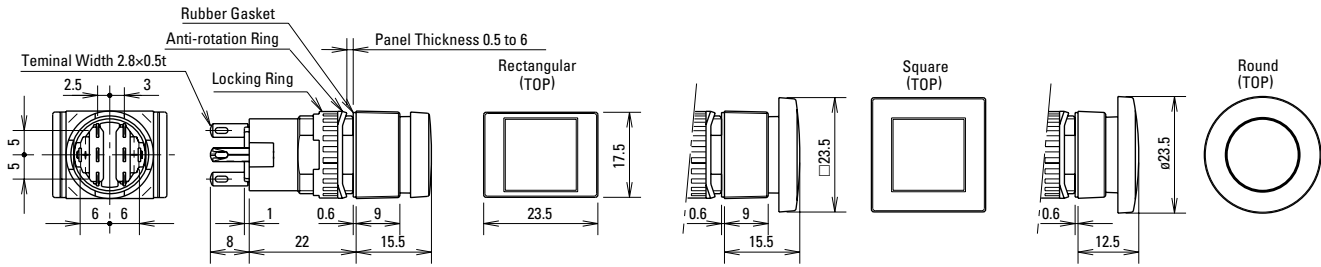

Selector Switches, Ø 5/8" (16mm)

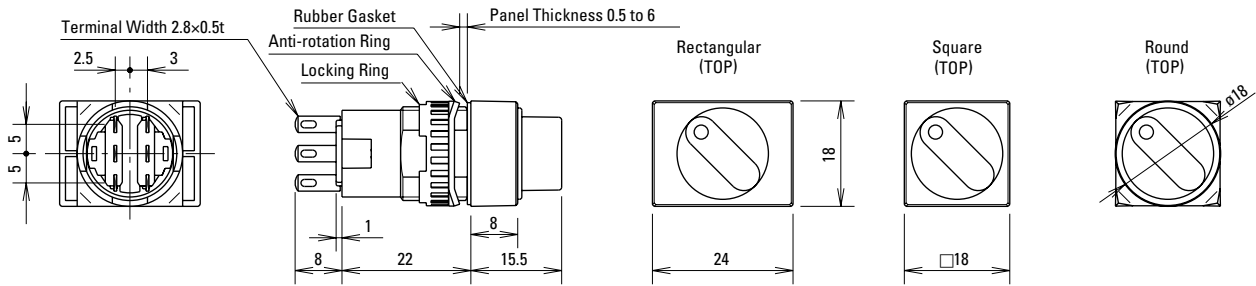

Key Selector Switches, Ø 5/8" (16mm)

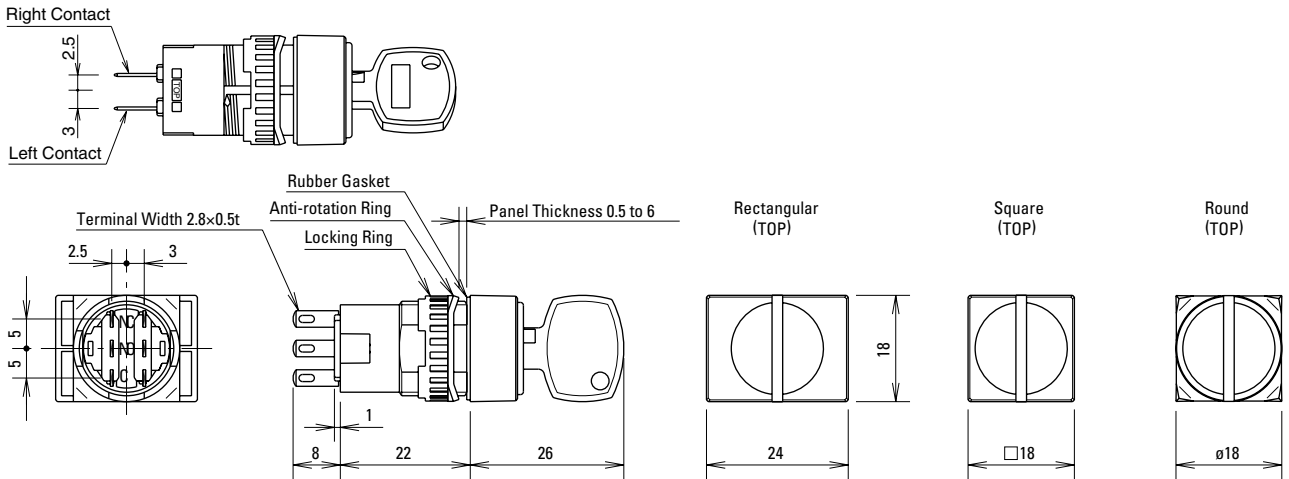

All dimensions are in mm.

Switch Guard, Ø 5/8" (16mm)

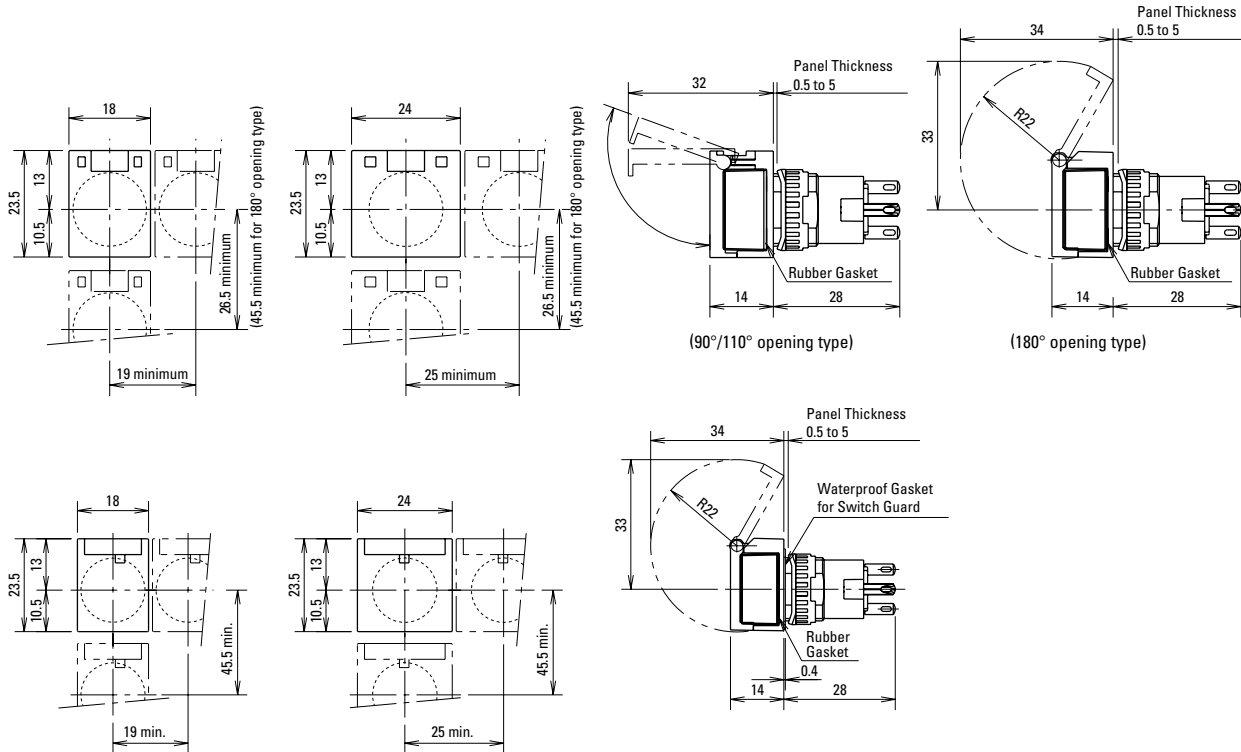

Flush Bezel

Flush Bezel with Switch

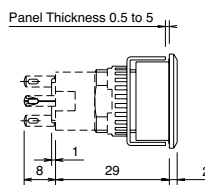
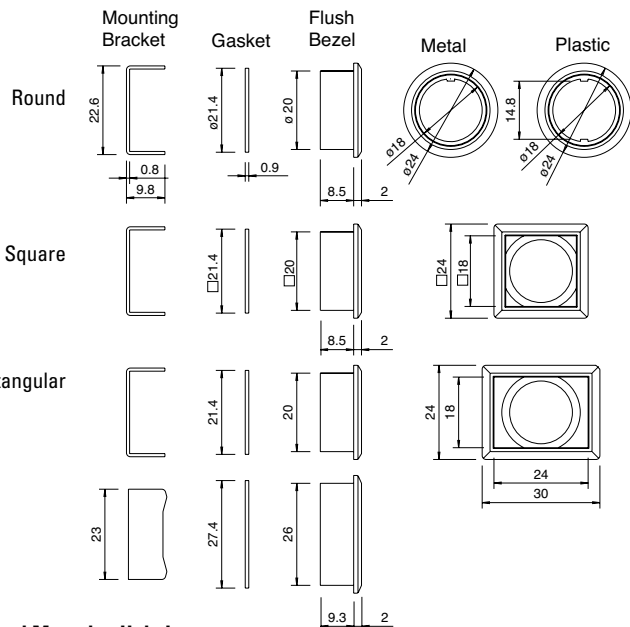

Selector Switches
Illuminated &
Non-illuminated

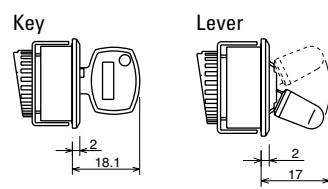

Flush Bezel Mounting Hole Layout

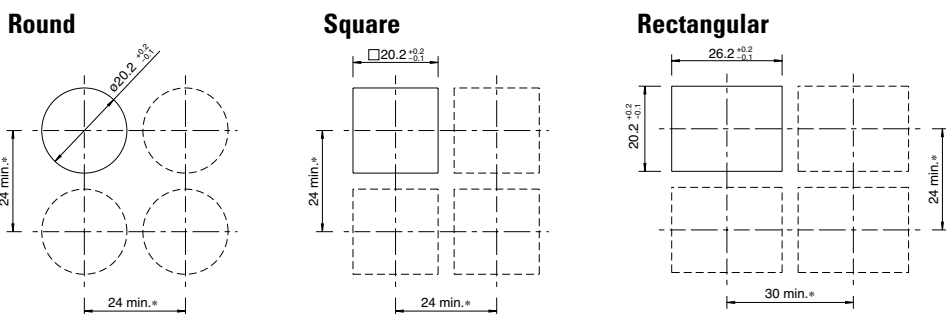

Switches & Pilot Devices

Signaling Lights

Relays & Sockets

Timers

Contactors

Terminal Blocks

Circuit Breakers

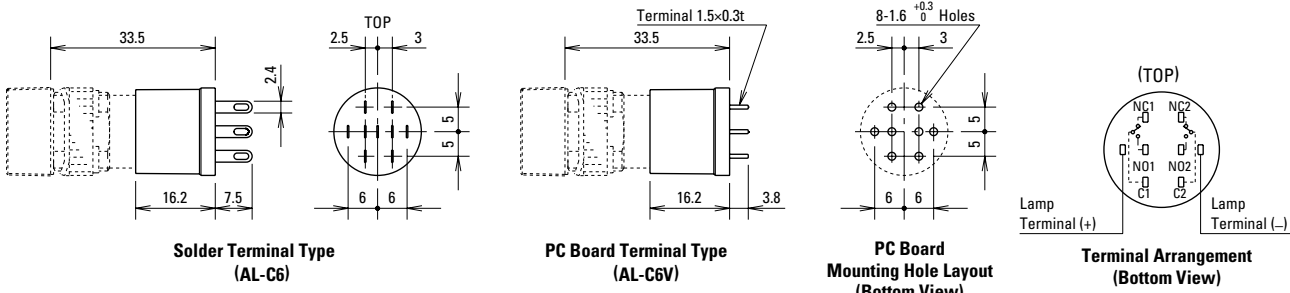

Terminal Sockets Dust Covers

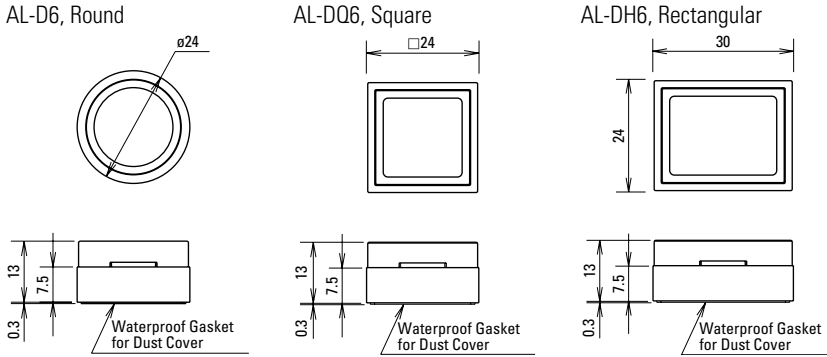

Pushbuttons with Standard Size Lens

Style	Round—AL6M-W	Square—AL6Q-W	Rectangular—AL6H-W
Dimensions			
Outside (OD)	(13.8mm)	(13.8mm)	(OD¹ x OD²) 13.8 x 19.8mm
Marking Area (a)	(12mm)	(12mm)	(a¹x a²) 12 x 18mm

Engraving must be made on the engraving area within 0.02" (0.5mm) deep.

Pushbuttons with Oversize Lens

Style	Round—AL6M-MW	Square/Rectangular—AL6Q-QW
Dimensions		
Outside (OD)	ø 0.491" (12.6mm)	0.491" (12.6mm)
Marking Area (a)	ø 0.429" (11mm)	0.429" (11mm)

Replacing and Marking Plate

Removal

Remove the lens holder assembly (lens, marking plate and holder) from the operator by holding the color lens recesses with the lens removal tool (Part No.MT-101) and pulling out. Remove marking plate by pushing the color lens from the rear to disengage the latches. Marking plate must be engraved on the side as shown in the figure on the right.
 ø 5/8" (16mm)

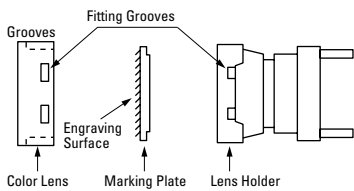

Installation

For illuminated pushbuttons:

1. Insert marking plate inside lens in correct direction
2. Press color lens on to lens holder to engage latches.
3. Insert lens holder into housing in correct direction.

Do not loosen spring on illuminated pushbutton units (except on pilot light units). The marking plate must be engraved on the front side as shown above.

L6 (Oversize) Series — Miniature Switches and Pilot Devices

Key features:

- 5/8" (16mm) mounting holes
- Locking lever removable contact blocks
- Solder terminal or PCB terminal options
- Available assembled or as sub-components
- Worldwide approvals
- Incandescent or LED illumination
- Snap action contacts



UL Recognized
File No. E55996



CSA Certified
File No. LR21451



Registration No. R9551089 (E-stops)
Registration No. J9551458 (all other switches)
Registration No. R95650511 (Pilot Lights)

Contact Ratings	Conforming to Standards	EN60947-1, EN60947-5-1, VDE0660-200, UL508, CSA C22-2 NO.14						
	Operating Temperature	Operation: -25 to +55°C (without freezing), 45 to 85% RH Storage: -30 to +80°C (without freezing)						
	Vibration Resistance	5 to 55Hz, 1.0 peak-peak amplitude max						
	Shock Resistance	Operating limit: 100 m/sec ² (approximately 10G) Damage limit: 1000 m/sec ² (approximately 100G)						
	Mechanical Life	Momentary pushbuttons 2,000,000 operations minimum All others: 250,000 operations minimum						
	Degree of Protection	IP65 (conforming to IEC 60529)						
	Dielectric Strength	Switch unit: between live and ground: 2500 volt AC, 1 minute between terminals of different poles: 2500 volt AC, 1 minute between terminals of same pole: 1000 volt AC, 1 minute Illumination unit: between live part and ground: 2500 volt AC, 1 minute						
	Insulation Resistance	100MΩ minimum (using 500V DC megger)						
	Rated Insulation Voltage	250V AC/DC						
	Rated Thermal Current	Gold Contacts (pcb): 3A Silver Contacts (solder): 5A						
	Contact Resistance	50Ω maximum initial value						
	Rated Operating Current		Silver Contacts (Solder Terminals)				Gold Clad Contacts (PCB terminals)	
			30V	125V	250V		30V	125V
		AC resistive	—	5A	2A	AC inductive	-	0.1A
	AC inductive	—	2A	1.5A	DC resistive	0.1A	—	
	DC resistive	3A	0.4A	—				
	DC inductive	1A	0.2A	—				
	Minimum Recommended Load (reference value for silver contacts)	5V AC/DC, 1mA						
	Terminal Style	0.110" Solder Tab /PCB						
	Contact Form	Snap Action, Double Throw						
	Contact Material	Solder Tab: Pure Silver /PCB: Gold Plated Silver						
	Electrical Life (at full load)	Momentary pushbuttons: 100,000 operations minimum (1800 operations / hour) All others: 100,000 operations minimum (1200 operations / hour)						
Lamp Ratings	Lamp Current Draw	5V DC LED: 8mA 6V AC/DC LED: 7mA 12V AC/DC LED: 8mA 24V AC/DC LED: 8mA 120V AC = 8mA		6V AC/DC incandescent: 100 mA 12V AC/DC incandescent: 50 mA 24V AC/DC incandescent: 25 mA				
	Lamp Life	Incandescent: 2000 hours./LED 50,000 hours. (on pure DC, half-life intensity)						

Switches & Pilot Devices

Signaling Lights

Relays & Sockets

Timers

Contactors

Terminal Blocks

Circuit Breakers

Built-in LED Lamp Ratings

Model	LFTD-5②	LFTD-1②	LFTD-2②	LFTD-H2②
Lamp Base	SX6S/8x5.4			
Rated Voltage	5V DC	12V AC/DC	24V AC/DC	120V AC
Operating Voltage	5V DC ±5%	12V AC/DC ±10%	24V AC/DC ±10%	120V AC ±5%
Current Draw	AC	9mA	9mA	8mA
	DC	8mA	8mA	—
Color Code ②	Specify a color code in place of ② in the Part No: A (amber), G (green), R (red), S (blue), W (white), Y (yellow)			
Lamp Base Color	Same as illumination color			
Voltage Marking	Stamped on the lamp base			
Life (reference value)	Approx. 50,000 hours			
Internal Circuit	A, R, W, Y	A, R, W, Y		
	G, S	G, S		

Non-Illuminated Pushbuttons (Assembled)

Non-Illuminated Pushbuttons

Style	Operation	Contact	Terminal Style	
			Solder Tab	PCB
	Momentary	SPDT	HA1B-M2C5-①	HA1B-M2C1V-①
		DPDT	HA1B-M2C6-①	HA1B-M2C2V-①
	Maintained	SPDT	HA1B-A2C5-①	HA1B-A2C1V-①
		DPDT	HA1B-A2C6-①	HA1B-A2C2V-①
	Momentary	SPDT	HA2B-M1C5-①	HA2B-M1C1V-①
		DPDT	HA2B-M1C6-①	HA2B-M1C2V-①
	Maintained	SPDT	HA2B-A1C5-①	HA2B-A1C1V-①
		DPDT	HA2B-A1C6-①	HA2B-A1C2V-①
	Momentary	SPDT	HA2B-M2C5-①	HA2B-M2C1V-①
		DPDT	HA2B-M2C6-①	HA2B-M2C2V-①
	Maintained	SPDT	HA2B-A2C5-①	HA2B-A2C1V-①
		DPDT	HA2B-A2C6-①	HA2B-A2C2V-①
	Momentary	SPDT	HA1B-M3C5-①	HA1B-M3C1V-①
		DPDT	HA1B-M3C6-①	HA1B-M3C2V-①
	Maintained	SPDT	HA1B-A3C5-①	HA1B-A3C1V-①
		DPDT	HA1B-A3C6-①	HA1B-A3C2V-①

① Button Color Codes

Color	Code	Color	Code
Black	B	Blue	S
Green	G	White	W
Red	R	Yellow	Y

- In place of ① specify Button Color Code from table.
- Illuminated (translucent) style lenses also available, specify as such: instead of LA1B-M1C5-① use LA1B-M1C5L-② in place of ② (specify Lens Color Code from next page.)
- PCB terminal models also available with silver contacts (change "1" or "2" to "5" or "6" respectively, ie LA1B-M1C1V-① becomes LA1B-M1C5V-①).

Non-Illuminated Pushbuttons (Sub-Assembled)

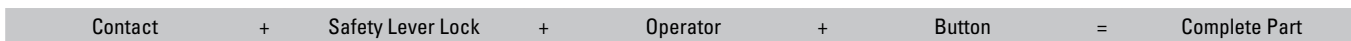





Operators



Style	Momentary	Maintained
Oversize Round 	HA1B-MO	HA1B-AO
Oversize Square 	HA2B-MO	HA2B-AO
Mushroom 	HA1B-MOL	HA1B-AOL

- 1. In place of ① specify Button Color Code from table on right.
- 2. In place of ② specify Lens Color Code from table on right.
- 3. *requires HA1L-MO or HA1L-AO operator instead of HA1B-MO or HA1B-AO.
- 4. **requires HA2L-MO or HA2L-AO instead of HA2B-MO or HA2B-AO.

Buttons/Lenses

Style	Button	Lens
Oversize Round Flush 	HA1A-B1-①	HA1A-L1-②*
Oversize Round Extended 	HA1A-B2-①	-
Oversize Square Flush 	HA2A-B1-①	HA2A-L1-②**
Oversize Square Extended 	HA2A-B2-①	-
Mushroom 	HA1A-B3-①	HA1A-L3-②

Contacts

Style	Contacts	Terminal Style	
		Solder Tab	PCB
	Gold SPDT DPDT	HA-C1	HA-C1V
		HA-C2	HA-C2V
	Silver SPDT DPDT	HA-C5	HA-C5V
		HA-C6	HA-C6V

Safety Lever Lock

Style	Part Number
	HA9Z-LS

① Button Color Code

Color	Code
Black	B
Green	G
Red	R
Blue	S
White	W
Yellow	Y

② Lens Color Code

Color	Code
Amber	A
Green	G
Red	R
Blue	S
Yellow	Y
White	W

HA1B/HA1E Stop Switch



Key features:

- PCB or Solder Terminals
- Locking Lever Removable Contact Blocks
- Positive Action Contacts
- 1 or 2 form B (SPST-NC) Contacts
- IP65 Protection
- 16mm Mounting Hole
- Tamper Proof Construction



Specifications

Contact Form	1 or 2 form B (SPST-NC)	
Termination	PCB or Solder Terminal	
Contact Material	Silver	
Applicable Standards	EN60947-5-1, UL508, CSA 22.2. No. 14	
Rated Insulation Voltage	250V AC/DC	
Degree of Protection	IP65	
Conditional Short-Circuit Current and Short-Circuit Protective Device	50 A (at 250V) 10A 250V Fuse, operation class M according to IEC269-1 and IEC269-2	
Positive Opening Operation	Positive opening travel	3.4mm
	Minimum force required to achieve positive opening operation of all break contacts.	10.3 N (2 form B contacts)
	Maximum travel including travel beyond the minimum travel position	5.5mm
	Maximum frequency of actuation	1,200 operations/hour
Pollution Degree	3	

Nameplates

HAAV–Yellow Plastic

Marking	Part Number
Blank	HAAV-0

Positive Action Stop Switch

Style	Operation	Contact	Terminal Style	
			Solder Tab	PCB
Stop Switch 	Pushlock/ Turn Reset	DPST(NC) (2 form B)	HA1B-V2E2R	HA1B-V2E2VR
		Short Body SPST-NC (1 form B) DPST-NC (2 form B)	HA1E-V2S1R HA1E-V2S2R	—

Accessories: Shroud

Style	Part Number	Applicable Standards
	XA9Z-KG1	SEMI S2 Compliant (Approved by TUV)

1. Button is non-removable, available in red and as complete assembled unit only.
2. Stop Switch does not come with safety lever lock.

Buzzers (IP40)

Style	Operating Voltage	Terminal Style	
		Solder/Tab	PCB
Buzzer-Rectangular 	6V AC/DC ± 10%	LA3Z-1X2	LA3Z-1X2V
	12V to 24 AC/DC ± 10%	LA3Z-1X4	LA3Z-1X4V

Buzzer Ratings

Frequency	2 khz ± 500 HZ
Amplitude	80db @ 0.1m (at rated voltage)
Operating Voltage	6V AC/DC or 12 - 24V AC/DC ± 10%
Adjustable Cycle	55 to 600 cycles per minute
Current Draw	DC: 7mA AC: 20mA
Life	1000 hrs. minimum
Insulation Voltage	60V AC/DC
Operating Temperature	-20 to 55°C (no freezing), 45 to 85% RH
Degree of Protection	IP40

Pilot Lights (Assembled)

Pilot Lights

Style	Terminal Style	
	Solder Tab	PCB
Oversize Round 	HA1P-1C0③-②	HA1P-1C0③V-②
Oversize Square 	HA2P-1C0③-②	HA2P-1C0③V-②
Oversize Round Unibody 	HA1P-1③-②	—
Oversize Square Unibody 	HA2P-1③-②	—

② Lens/LED Color Codes

Color	Code
Amber	A
Green	G
Red	R
Blue	S
White	W
Yellow	Y

③ Voltage/Lamp Code

Voltage	Code
5V DC LED	1
6V AC/DC LED	2
12V AC/DC LED	3
24V AC/DC LED	4
120V AC LED	8
6V AC/DC Incandescent	5
12V AC/DC Incandescent	6
24V AC/DC Incandescent	7

- 1. In place of ② specify Lens/LED Color Code from table.
- 2. In place of ③ specify Voltage Code from table.

Pilot Lights (Sub-Assembled)

Terminals + Safety Lever Lock + Lamp Holder + Lamp + Operator + Lens = Completed Unit



Operators

Style	Part Number
Oversize Round	HA1P-0
Oversize Square	HA2P-0
Oversize Round Unibody	HA1P-00
Oversize Square Unibody	HA2P-00

Lenses

Style	Part Number
Oversize Round	HA1A-P1-②
Oversize Square	HA2A-P1-②

In place of ② specify lens color code.

Lamps

Style	Voltage	Part Number
LED	5V DC	LFTD-5②
	6V AC/DC	LFTD-6②
	12V AC/DC	LFTD-1②
	24V AC/DC	LFTD-2②
	120 V AC	LFTD-H2②
Incandescent	6V AC/DC	LH-06
	12V AC/DC	LH-14
	24V AC/DC	LH-28

In place of ② specify LED color code from table below.

Terminals

Style	Solder Tab	PCB
	HA-C00	HA-C00V

Not required for unibody operators.

Lamp Holder

Style	Part Number
	HA9Z-AH

Safety Lever Lock

Style	Part Number
	HA9Z-LS

② Lens/LED Color Codes

Color	Code
Amber	A
Green	G
Red	R
Blue	S
Yellow	Y
White	W

Illuminated Pushbuttons (Assembled)

Illuminated Pushbuttons

Style	Operation	Contact	Terminal Style	
			Solder Tab	PCB
Oversize Round 	Momentary	SPDT DPDT	HA1L-M1C5③-② HA1L-M1C6③-②	HA1L-M1C1③V-② HA1L-M1C2③V-②
	Maintained	SPDT DPDT	HA1L-A1C5③-② HA1L-A1C6③-②	HA1L-A1C1③V-② HA1L-A1C2③V-②
Oversize Square 	Momentary	SPDT DPDT	HA2L-M1C5③-② HA2L-M1C6③-②	HA2L-M1C1③V-② HA2L-M1C2③V-②
	Maintained	SPDT DPDT	HA2L-A1C5③-② HA2L-A1C6③-②	HA2L-A1C1③V-② HA2L-A1C2③V-②
Mushroom 	Momentary	SPDT DPDT	HA1L-M3C5③-② HA1L-M3C6③-②	HA1L-M3C1③V-② HA1L-M3C2③V-②
	Maintained	SPDT DPDT	HA1L-A3C5③-② HA1L-A3C6③-②	HA1L-A3C1③V-② HA1L-A3C2③V-②

② Lens Color Codes

Color	Code
Amber	A
Green	G
Red	R
Blue	S
Yellow	Y
White	W

③ Voltage/Lamp Code

Voltage	Code
5V DC LED	1
6V AC/DC LED	2
12V AC/DC LED	3
24V AC/DC LED	4
120 V AC LED	8
6V AC/DC Incandescent	5
12V AC/DC Incandescent	6
24V AC/DC Incandescent	7

- 1. In place of ② specify Lens Color Code from table.
- 2. In place of ③ specify Voltage Code from table.
- 3. PCB terminal models also available with silver contacts change "1" or "2" to "5" or "6" respectively, (ie LA1L-M1C14V-④ becomes LA1L-M1C54V-④).
- 4. Light independent of switch position.

Illuminated Pushbuttons (Sub-Assembled)

Terminals + Safety Lever Lock + Lamp Holder + Lamp + Operator + Lens = Completed Unit



Operators

Style	Momentary	Maintained
Oversize Round 	HA1L-MO	HA1L-AO
Oversize Square 	HA2L-MO	HA2L-AO
Mushroom 	HA1B-MOL	HA1B-AOL



Lenses

Style	Part Number
Oversize Round 	HA1A-L1-②
Oversize Square 	HA2A-L1-②
Mushroom 	HA1A-L3-②





In place of ② specify lens color code.

Lamps

Style	Voltage	Part Number
LED 	5V DC	LFTD-5②
	6V AC/DC	LFTD-6②
	12V AC/DC	LFTD-1②
	24V AC/DC	LFTD-2②
	120 V AC	LFTD-H2②
Incandescent 	6V AC/DC	LH-06
	12V AC/DC	LH-14
	24V AC/DC	LH-28

Contacts

Style	Contacts	Terminal Style	
		Solder Tab	PCB
	Gold	SPDT	HA-C10
		DPDT	HA-C20
	Silver	SPDT	HA-C50
		DPDT	HA-C60

Lamp Holder

Style	Part Number
	HA9Z-AH

Safety Lever Lock

Style	Part Number
	HA9Z-LS

② **Lens/LED Color Codes**

Color	Code
Amber	A
Green	G
Red	R
Blue	S
Yellow	Y
White	W

Selector Switches (Assembled)

Selector Switches

Style	Position	Contact	Terminal Style		
			Solder Tab	PCB	
Oversize Round	90° 2-Position	Maintained	DPDT	HA1S-2C6	HA1S-2C2V
		Spring return from right	DPDT	HA1S-21C6	HA1S-21C2V
Oversize Round	45° 3-Position	Maintained	DPDT	HA1S-3C6	HA1S-3C2V
		Spring return from right	DPDT	HA1S-31C6	HA1S-31C2V
		Spring return from left	DPDT	HA1S-32C6	HA1S-32C2V
		2-Way spring return	DPDT	HA1S-33C6	HA1S-33C2V



1. All assembled selector switches use DPDT contacts.
2. For SPDT contacts see sub-components on next page.
3. PCB terminal models also available with silver contacts change "1" or "2" to "5" or "6" respectively, (ie LA1S-21C2V becomes LA1S-21C6V).

Contact Operations

(for all selectors)

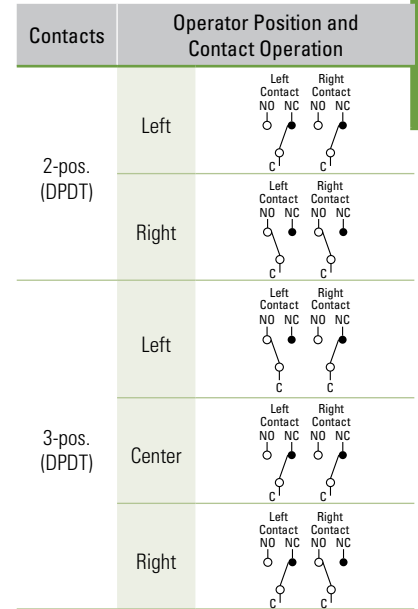

As viewed from front of switch.

Switches & Pilot Devices

Signaling Lights

Relays & Sockets

Timers

Contactors

Terminal Blocks

Circuit Breakers

Selector Switches (Sub-Assembled)

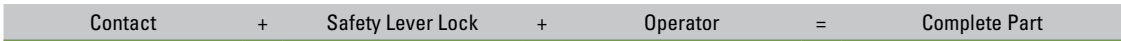

Operators

Style	Position	Function	Part Number
 Oversize Round	2	Maintained Spring from right	HA1S-2Y HA1S-21Y
	3	Maintained Spring from right Spring from left Spring from both	HA1S-3Y HA1S-31Y HA1S-32Y HA1S-33Y

Safety Lever Lock

Style	Part Number
	HA9Z-LS

Contacts







Style	Contacts	Terminal Style	
		Solder Tab	PCB
 Gold	SPDT DPDT	HA-C1 HA-C2	HA-C1V HA-C2V
	SPDT DPDT	HA-C5 HA-C6	HA-C5V HA-C6V



1. All assembled switches listed on previous page use DPDT contacts.
2. SPDT Contacts for use on 2 position selector switch only

Key Switches (Assembled)

Key Switches

Style	Position	Contact	Terminal Style		
			Solder Tab	PCB	
Oversize Round 	90° 2-Position	Maintained 	DPDT	HA1K-2C6 [ⓐ]	HA1K-2C2V [ⓐ]
		Spring return from right 	DPDT	HA1K-21C6B	HA1K-21C2VB
	45° 3-Position	Maintained 	DPDT	HA1K-3C6 [ⓐ]	HA1K-3C2V [ⓐ]
		Spring return from right 	DPDT	HA1K-31C6 [ⓐ]	HA1K-31C2V [ⓐ]
		Spring return from left 	DPDT	HA1K-32C6 [ⓐ]	HA1K-32C2V [ⓐ]
		2-Way spring return 	DPDT	HA1K-33C6D	HA1K-33C2VD

-  1. In place of [ⓐ] specify Key Retention Code from next page.
- 2. All assembled key switches have DPDT contacts. For SPDT see sub-assembled on next page.
- 3. PCB terminal models also available with silver contacts change "1" or "2" to "5" or "6" respectively, (ie LA1K-2C2V[ⓐ] becomes LA1K-2C6V[ⓐ]).

Contact Operations

(for all selectors)

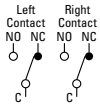
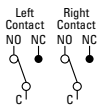
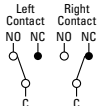
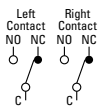
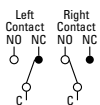
Contacts	Operator Position and Contact Operation	
2-pos. (DPDT)	Left	
	Right	
3-pos. (DPDT)	Left	
	Center	
	Right	

 As viewed from front of switch.

[ⓐ] Key Retention Option Codes

Code	Description
A	Key not retained in any position (removable in all positions)
B	Key retained in right position only
C	Key retained in left position only
D	Key retained in left and right (3 position only)
E	Key retained in center only (3 position only)
G	Key retained right and center (3 position only)
H	Key retained left and center (3 position only)

 Key cannot be removed from a spring-return position.

Selector Switches (Sub-Assembled)



Contact + Safety Lever Lock + Operator = Complete Part



Operators

Style	Position	Function	Part Number
Oversize Round 	2	Maintained Spring from right	HA1K-2ⓐ HA1K-21B
	3	Maintained Spring from right Spring from left Spring from both	HA1K-3ⓐ HA1K-31ⓐ HA1K-32ⓐ HA1K-33D

Contacts

Style	Contacts	Terminal Style	
		Solder Tab	PCB
	SPDT DPDT	HA-C1	HA-C1V
		HA-C2	HA-C2V
	SPDT DPDT	HA-C5	HA-C5V
		HA-C6	HA-C6V

-  1. All assembled switches listed on previous page use DPDT contacts.
- 2. SPDT Contacts for use on 2 position selector switch only

Safety Lever Lock

Style	Part Number
	HA9Z-LS

ⓐ Key Retention Option Codes





























Code	Description
A	Key not retained in any position (removable in all positions)
B	Key retained in right position only
C	Key retained in left position only
D	Key retained in left and right (3 position only)
E	Key retained in center only (3 position only)
G	Key retained right and center (3 position only)
H	Key retained left and center (3 position only)

-  Key cannot be removed from a spring-return position.

-  1. In place of ⓐ specify key removable code from table on right.
- 2. Operator includes two keys.

Illuminated Selector Switches (Assembled)

Illuminated Selector Switches

Style	Position	Contact	Terminal Style		
			Solder Tab	PCB	
 Round	90° 2-Position	Maintained 	DPDT	LA1F-2C6②-②	LA1F-2C2③V-②
		Spring return from right 	DPDT	LA1F-21C6③-②	LA1F-21C2③V-②
	45° 3-Position	Maintained 	DPDT	LA1F-3C6③-②	LA1F-3C2③V-②
		Spring return from right 	DPDT	LA1F-31C6③-②	LA1F-31C2③V-②
		Spring return from left 	DPDT	LA1F-32C6③-②	LA1F-32C2③V-②
		2-Way spring return 	DPDT	LA1F-33C6③-②	LA1F-33C2③V-②
 Square	90° 2-Position	Maintained 	DPDT	LA2F-2C6③-②	LA2F-2C2③V-②
		Spring return from right 	DPDT	LA2F-21C6③-②	LA2F-21C2③V-②
	45° 3-Position	Maintained 	DPDT	LA2F-3C6③-②	LA2F-3C2③V-②
		Spring return from right 	DPDT	LA2F-31C6③-②	LA2F-31C2③V-②
		Spring return from left 	DPDT	LA2F-32C6③-②	LA2F-32C2③V-②
		2-Way spring return 	DPDT	LA2F-33C6③-②	LA2F-33C2③V-②
 Rectangular	90° 2-Position	Maintained 	DPDT	LA3F-2C6③-②	LA3F-2C2③V-②
		Spring return from right 	DPDT	LA3F-21C6③-②	LA3F-21C2③V-②
	45° 3-Position	Maintained 	DPDT	LA3F-3C6③-②	LA3F-3C2③V-②
		Spring return from right 	DPDT	LA3F-31C6③-②	LA3F-31C2③V-②
		Spring return from left 	DPDT	LA3F-32C6③-②	LA3F-32C2③V-②
		2-Way spring return 	DPDT	LA3F-33C6③-②	LA3F-33C2③V-②
 Oversize Round	90° 2-Position	Maintained 	DPDT	HA1F-2C6③-②	HA1F-2C2③V-②
		Spring return from right 	DPDT	HA1F-21C6③-②	HA1F-21C2③V-②
	45° 3-Position	Maintained 	DPDT	HA1F-3C6③-②	HA1F-3C2③V-②
		Spring return from right 	DPDT	HA1F-31C6③-②	HA1F-31C2③V-②
		Spring return from left 	DPDT	HA1F-32C6③-②	HA1F-32C2③V-②
		2-Way spring return 	DPDT	HA1F-33C6③-②	HA1F-33C2③V-②

Contact Operations

(for all selectors)

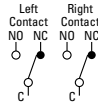
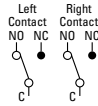
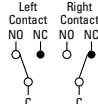
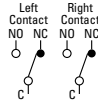
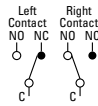
Contacts	Operator Position and Contact Operation	
2-pos. (DPDT)	Left	
	Right	
3-pos. (DPDT)	Left	
	Center	
	Right	



As viewed from front of switch.

② Lens/LED Color Codes

Color	Code	Color	Code
Amber	A	Blue	S
Green	G	Yellow	Y
Red	R	White	W

③ Voltage/Lamp Code

Voltage	Code
5V DC LED	1
6V AC/DC LED	2
12V AC/DC LED	3
24V AC/DC LED	4
120V AC LED	8
6V AC/DC Incandescent	5
12V AC/DC Incandescent	6
24V AC/DC Incandescent	7



- In place of ② specify Lens/LED Color Code from table above.
- In place of ③ specify Voltage Code from table above.
- All switches listed have DPDT contacts. For SPDT see sub-assembled on next page.
- PCB terminal models also available with silver contacts change "1" or "2" to "5" or "6" respectively, (ie LA1F-2C24V-② becomes LA1F-2C64V-②).
- Light independent of switch position.

Illuminated Selector Switches (Sub-Assembled)

Contacts + Safety Lever Lock + Lamp Holder + Lamp + Operator + Lens/Handle = Completed Unit



Operators

Style	Position	Function	Part Number
Round	2	Maintained Spring from right	LA1F-20 LA1F-210
	3	Maintained Spring from right Spring from left Spring from both	LA1F-30 LA1F-310 LA1F-320 LA1F-330
	2	Maintained Spring from right	LA2F-20 LA2F-210
Square	3	Maintained Spring from right Spring from left Spring from both	LA2F-30 LA2F-310 LA2F-320 LA2F-330
	2	Maintained Spring from right	LA3F-20 LA3F-210
	3	Maintained Spring from right Spring from left Spring from both	LA3F-30 LA3F-310 LA3F-320 LA3F-330
Rectangular	2	Maintained Spring from right	HA1F-20 HA1F-210
	3	Maintained Spring from right Spring from left Spring from both	HA1F-30 HA1F-310 HA1F-320 HA1F-330
Oversize Round	2	Maintained Spring from right	HA1F-20 HA1F-210
	3	Maintained Spring from right Spring from left Spring from both	HA1F-30 HA1F-310 HA1F-320 HA1F-330

Safety Lever Lock

Style	Part Number
	HA9Z-LS

Lamp Holder

Style	Part Number
	HA9Z-AH

Lamps

Style	Voltage	Part Number
LED	5V DC	LFTD-5Ⓜ
	6V AC/DC	LFTD-6Ⓜ
	12V AC/DC	LFTD-1Ⓜ
	24V AC/DC	LFTD-2Ⓜ
	120V AC	LFTD-H2Ⓜ
Incandescent	6V AC/DC	LH-06
	12V AC/DC	LH-14
	24V AC/DC	LH-28

In place of Ⓜ specify LED color code from table below.

Contacts

Style	Contacts	Terminal Style	
		Solder Tab	PCB
	SPDT	HA-C10	HA-C10V
	DPDT	HA-C20	HA-C20V
	SPDT	HA-C50	HA-C50V
	DPDT	HA-C60	HA-C60V

Lenses/Handles

Style	Part Number
Standard 	LA1A-F-Ⓜ
Oversize 	HA1A-F-Ⓜ

Ⓜ Lens/LED Color Codes

Color	Code
Amber	A
Green	G
Red	R
Blue	S
Yellow	Y
White	W

All assembled selectors on previous pages use DPDT contacts. SPDT contacts are for use only on two position selectors.

In place of Ⓜ specify lens color code from table.

Pushbutton Selectors (Assembled)

Pushbutton Selectors

Style		Terminal Style	
		Solder Tab	PCB
	2 Position	HA1R-2C6-Ⓞ	HA1R-2C2V-Ⓞ
	3 Position	HA1R-3C6-Ⓞ	HA1R-3C2V-Ⓞ

- 1. In place of Ⓞ specify Button Color Code.
- 2. PCB terminal models also available with silver contacts (change "1" or "2" to "5" or "6" respectively, ie HA1R-2C2V-Ⓞ becomes HA1R-2C6V-Ⓞ).
- 3. Pushed position, momentary only.

Contact Operation

Style	Operator Position					
	Left		Center		Right	
	Normal	Pushed	Normal	Pushed	Normal	Pushed
2 Position			—	—		
3 Position				Blocked		

① Button Color Codes

Color	Code	Color	Code
Amber	A	Blue	S
Green	G	Yellow	Y
Red	R	White	W

Contact Operation

Contacts	Operator Position and Contact Information	Operator Position and Contact Information			
		Down	Center	Up	
2-pos. (DPDT)	Maintained Spring from Top				
2-pos. (DPDT)	Spring Return from Bottom				
3-pos. (DPDT)	All models				

 As viewed from front of switch.

Lever Switches

Style	Operation	Contacts	Terminal Type		
			Solder Tab	PCB	
	Maintained		DPDT	LA1T-2C6	LA1T-2C2V
	Spring return from top		DPDT	LA1T-21C6	LA1T-21C2V
	Spring return from bottom		DPDT	LA1T-22C6	LA1T-22C2V
3-Position	Maintained		DPDT	LA1T-3C6	LA1T-3C2V
	Spring return from top		DPDT	LA1T-31C6	LA1T-31C2V
	Spring return from bottom		DPDT	LA1T-32C6	LA1T-32C2V
	Spring return from both		DPDT	LA1T-33C6	LA1T-33C2V

- 1. PCB terminal models also available with silver contacts (change "1" or "2" to "5" or "6" respectively, ie LA1T-2C2V becomes LA1T-2C6V).
- 2. Terminology: U = up, D = down, C = center.

Switch Engraving Order Form – L6 Series

Copy this order form and use it to specify Letter Height, Maximum Number of Lines and Text to be engraved.

To insure engraving accuracy, fax it to your IDEC representative or Distributor.

Your Company: _____
 Name: _____
 Address: _____
 PO: _____

Telephone: _____
 Fax: _____
 Email: _____
 Part Number to be Engraved: _____

Please check one of the boxes below to indicate your choice of engraving options:

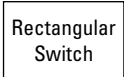

	# of Lines	Letter Height	Max. Characters Per Line
<input type="checkbox"/>	1	5/32	6
<input type="checkbox"/>	2	5/32	6
<input type="checkbox"/>		1/8	6
<input type="checkbox"/>	3	1/8	6
<input type="checkbox"/>	4	N/A	

	# of Lines	Letter Height	Max. Characters Per Line
<input type="checkbox"/>	1	5/32	5
<input type="checkbox"/>	2	5/32	5
<input type="checkbox"/>		1/8	6
<input type="checkbox"/>	3	1/8	6
<input type="checkbox"/>	4	N/A	

	# of Lines	Letter Height	Max. Characters Per Line
<input type="checkbox"/>	1	5/32	3
<input type="checkbox"/>		1/8	3
<input type="checkbox"/>	2	Custom*	
<input type="checkbox"/>	3	Custom*	
<input type="checkbox"/>	4	N/A	

*Engraving is possible, but character size will be smaller than standard sizes.



- Above mentioned specifications hold true for standard size pushbuttons (round, square and rectangular).
- Oversize pushbuttons and pilot lights allow you to engrave 1 additional character.
- Engraving is done on the button itself for non-illuminated push buttons and on marking plate for illuminated pushbuttons and pilot lights.
- Please enter text exactly how you want it engraved, take care to emphasize capital or small letters.

Enter text to be engraved:

Line 1: _____
 Line 2: _____
 Line 3: _____
 Line 4: _____

Sample Letter Sizes

1/8 Letters: **OPEN**

5/32 Letters: **OPEN**

For IDEC Internal Use Only:
 Work Order #: _____

Accessories

Item	Appearance	Specifications	Part Number	Notes	
Ring Wrench		Made of metal	MT-001	Used for tightening the plastic locking ring when installing the L6 series unit on a panel. Tightening torque should not exceed 9kgf cm when tightening the locking ring.	
Lamp Holder Tool (Made of Rubber)		Made of rubber. Used for removing and replacing LED and incandescent lamps in illuminated units.	OR-44	Rubber tool used for replacing LED and incandescent lamps.	
Lens Removal Tool		For illuminated pushbuttons and pilot lights.	MT-101	Used for removing the lens or button from the housing.	
LED Lamp		5V DC 6V AC/DC 12V AC/DC 24V AC/DC 120V AC	LFTD-5Ⓞ LFTD-6Ⓞ LFTD-1Ⓞ LFTD-2Ⓞ LFTD-H2Ⓞ	T 1-3/4 miniature flange base. In place of Ⓞ specify LED Color Code (A, G, R, S, W, Y).	
Incandescent Lamp		6V AC/DC 12V AC/DC 24V AC/DC	LH-06 LH-14 LH-28	0.5W, T 1-3/4 miniature flange base	
Switch Guard		180 degrees opening, spring return	Oversize Round/Sq HA9Z-K1	Prevents inadvertent switch operation. IP65 oiltight rated.	
Terminal Cover		Made of white nylon	All removable contacts	H6-VL2	Covers terminals to prevent possible electric shock.
			Unibody Pilot Lights	H6-PVL	
Mounting Hole Plug		Rubber	AL-B6	Fills unused panel cutouts. Made of nitrile rubber. Push-in installation from front of panel. IP65 (oiltight) rated.	
		Aluminum	AL-BM6	Fills unused panel cutouts. Made of aluminum. Screw-on locking ring from inside of panel. IP65 (oiltight) rated.	
Replacement Keys		for HA1K (#231) – oversize	KG9Z-SK	Pair of keys.	
Replacement Engraving Inserts			Oversize Round Oversize Square Mushroom HA9Z-P1-W HA9Z-P2-W HA9Z-P13-W		
Replacement Locking Ring		All models	HA9Z-LN		
Replacement Anti-Rotation Ring			L6 oversize HA9Z-LP	Prevents rotation of switches in panel. (included with all assembled switches)	
Replacement Selector Inserts			HA9Z-HC1-Ⓞ	Applicable to round oversize selectors only Ⓞ = (G, R, S, W, Y)	
Replacement Safety Lever Lock			HA9Z-LS		

Switches & Pilot Devices

Signaling Lights

Relays & Sockets

Timers

Contactors

Terminal Blocks

Circuit Breakers

Item	Appearance	Description	Used With	Part Number
Flush Bezel		ø24mm round, metal (aluminum color), panel cut-out ø20.2mm	Illuminated selector switches.	LA9Z-SM61
		ø24mm round, plastic (black), panel cut-out ø20.2mm		LA9Z-S61B
		□24mm square, plastic (black), panel cut-out □20.2mm	+	LA9Z-S71B
		24 x 30mm rectangular, plastic (black), panel cut-out ø20.2 x 26.2mm	=	LA9Z-S81B
Switch Guard w/ Flush Bezel (spring return)		Rectangular, plastic (black)	Flush Switch	LA9Z-KS8

Flush bezels not applicable for oversize units.

Dimensions (mm)

Lever Switches (LA1T)

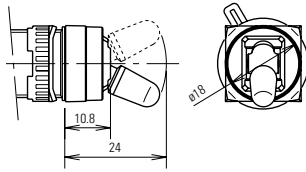

Buzzer (LA3Z)

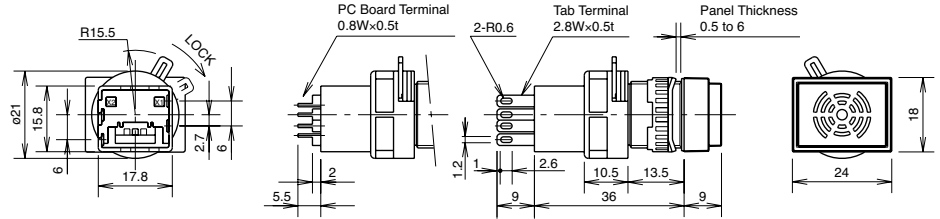

Emergency Stop Switch (HA1B)

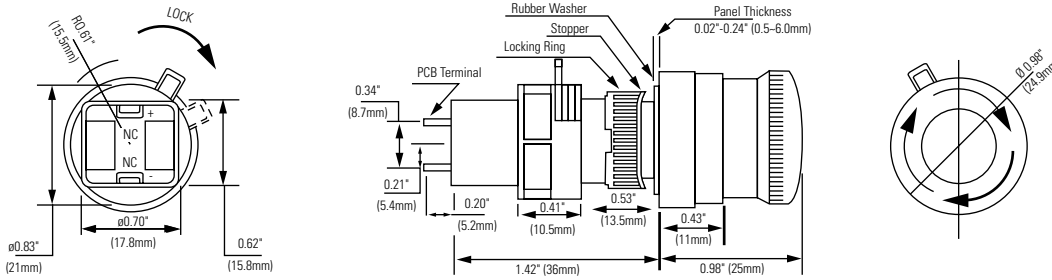

Emergency Stop Switch (HA1E) - Short Body Style



Illuminated Selector Switches (LA*F)

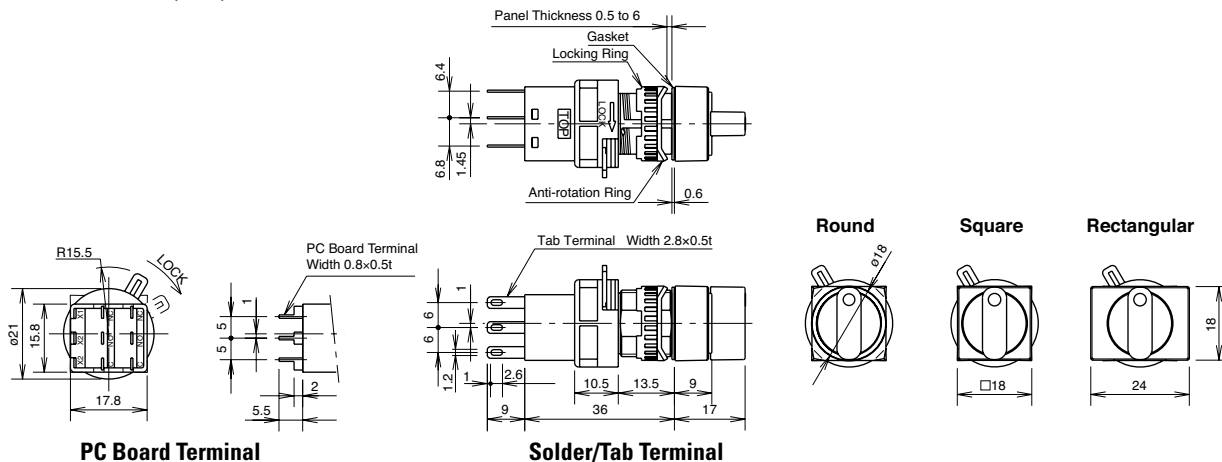

PC Board Drilling Layout (Bottom View)

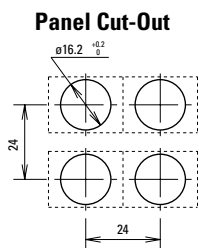

Illuminated Pushbuttons, Illuminated Selector Switches

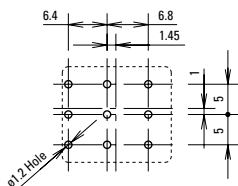

Pilot Lights, Selector Switches, Key Selector Switches

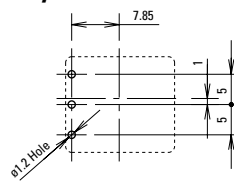

Pushbutton Lever Switches

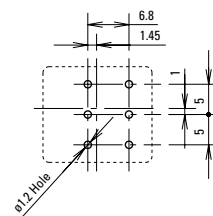

HA1B E-Stop

PCB Mounting Pattern

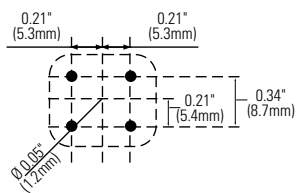

Oversize Flush Pushbutton and Pilot Lights

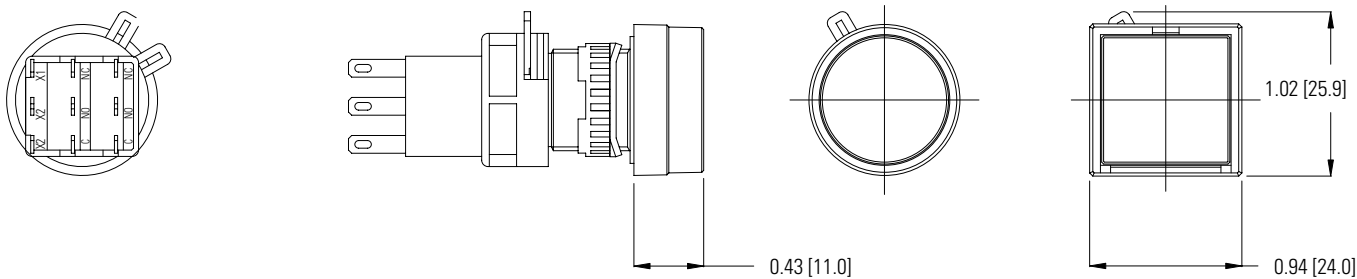

Switches & Pilot Devices

Enlarge Extended Non-Illuminated Pushbutton

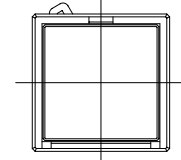
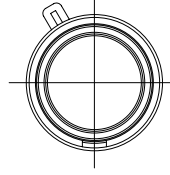
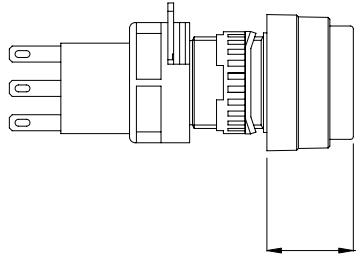
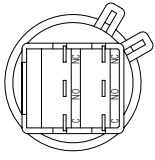

Signaling Lights

Enlarge Unibody Pilot Lights

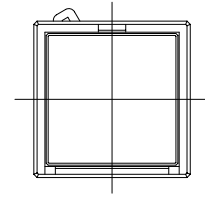
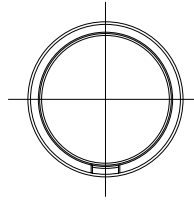
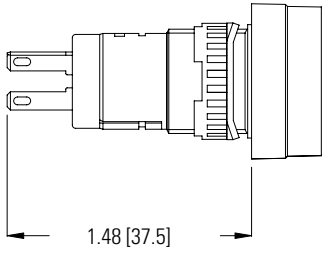
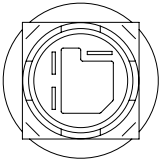

Relays & Sockets

Mushroom Pushbuttons

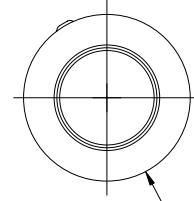
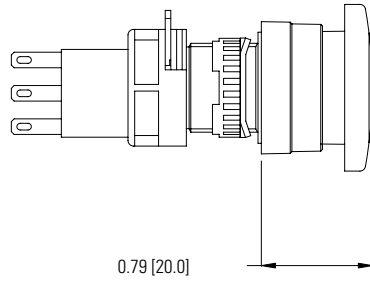
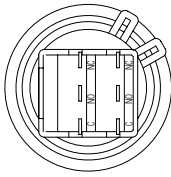

1.18 [30.0]

Timers

Enlarge Selector Switch

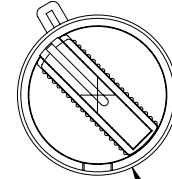
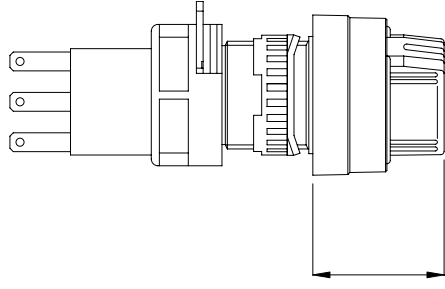
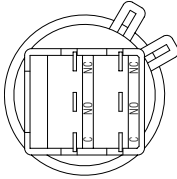

0.94 [23.8]

Contactors

Terminal Blocks

Circuit Breakers

Oversize Key Switch

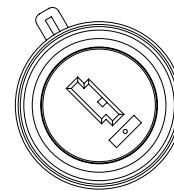
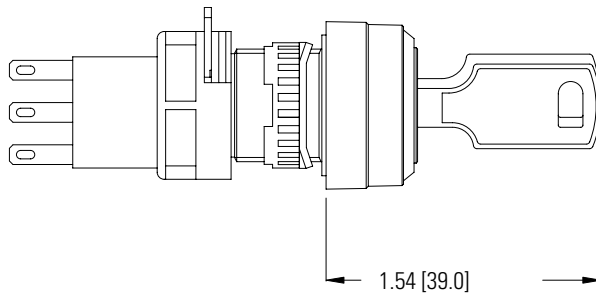
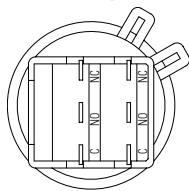

Lever Switch

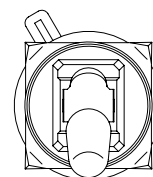
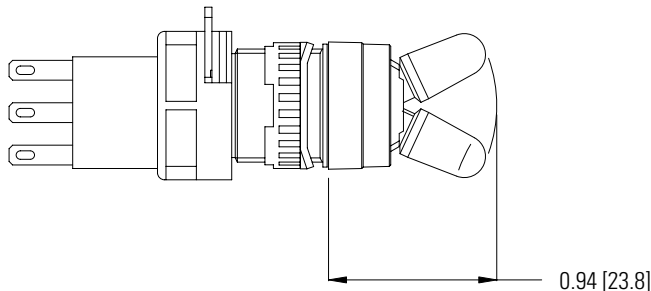
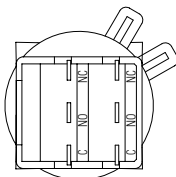

Flush Bezel

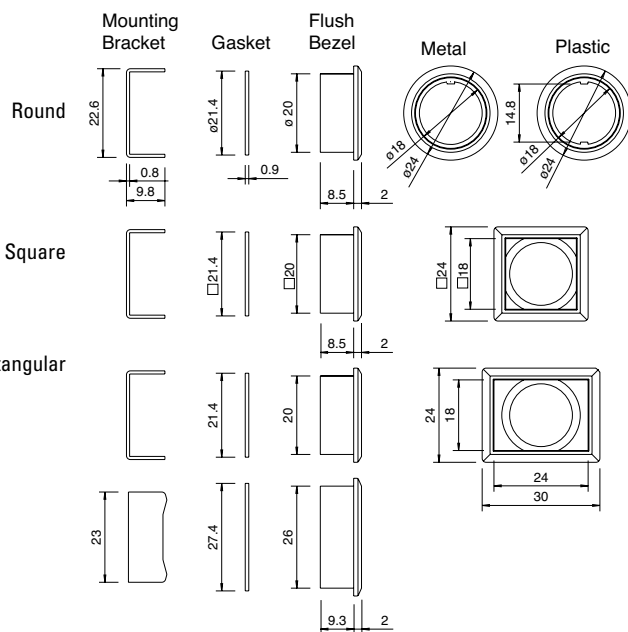

Selector Switches

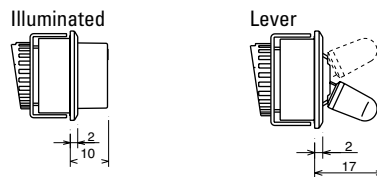

Flush Bezel Mounting Hole Layout

Round

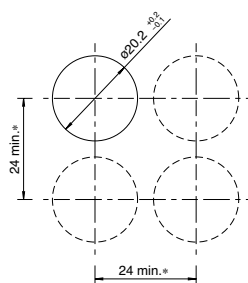

Square

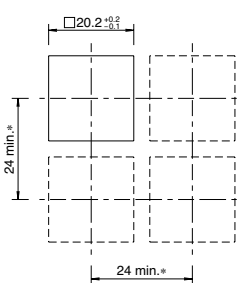

Rectangular

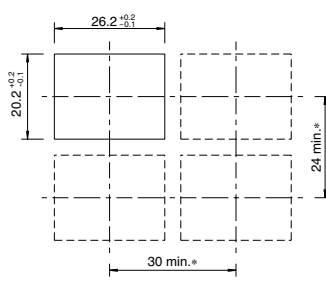

Terminal Configurations

Non Illuminated Pushbutton

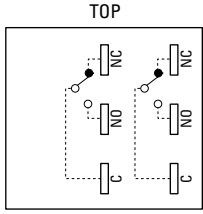

Pilot Lights

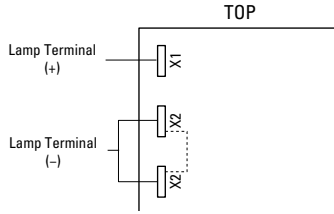

AL-K6SP

Illuminated Pushbuttons

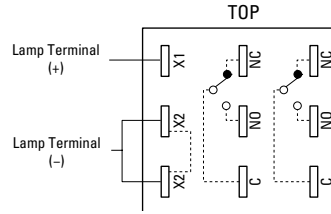

Buzzer

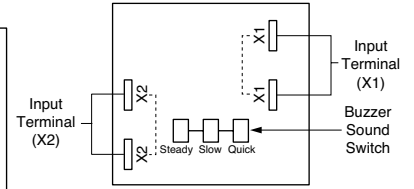

H6-VL2

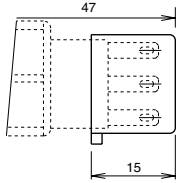

AL-B6

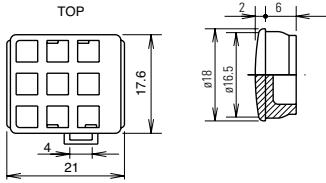

AL-BM6

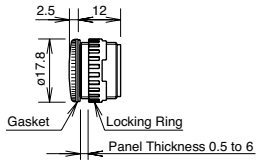

LFTD

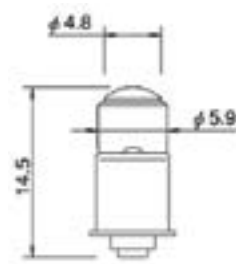

LED Lamp Internal Circuit

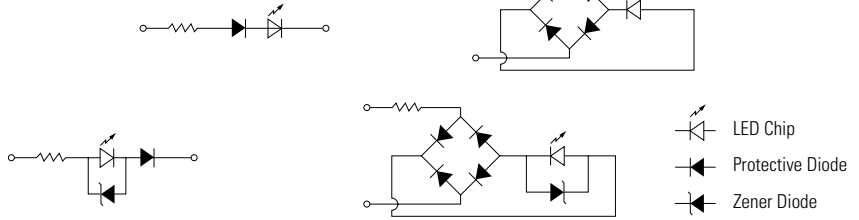

AL-B6

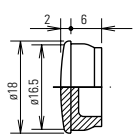

General Instructions

Pushbutton Assembly

Lamp Installation

Lamps can be replaced in two ways:

1. If contacts are accessible (or pushbutton not installed in a panel) then it is easiest to first remove the contacts from the operator. This will allow easy access to the lamp/lamp-holder assembly. Grab lamp, depress slightly, and turn counter clockwise. Lamp can then be removed by pushing it back through the lamp holder.
2. If contacts are not accessible, then the lamp can be replaced by first removing the lens from the operator. Just pull lens straight out either with a fingernail or optional lens removal tool (MT-101). Lamp/lamp-holder assembly can then be removed with lamp removal tool (OR-44). Insert lamp removal tool through operator, depress slightly, turn counter clockwise, then pull lamp/lamp-holder assembly out. Lamp can then be removed by pushing it back through the lamp holder.



Engraving Lenses

All buttons and lenses can be engraved directly on the outside surface. Illuminated lenses also allow for engraving on a plate that is underneath the colored section of the lens. Remove the colored section of the lens by pulling on the edge while simultaneously unhooking it from the latches on the lens holder. The marking plate will then be accessible. It can then be engraved or a thin marked insert (such as mylar or paper) can be sandwiched between the marking plate and colored section of the lens.

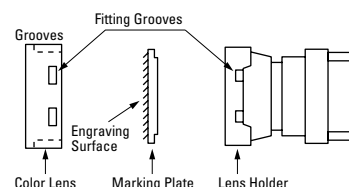

Panel Mounting

Before any unit can be mounted into a panel, the contact block must be removed. Slide metal locking lever and pull contact off. Loosen and remove the locking ring and square anti-rotation ring from the operator and insert operator through panel cutout from the front of the panel. Slide on anti-rotation ring and tighten locking ring, using locking ring wrench (MT-001). Slide contact block onto operator, observing TOP marking on both parts. Slide metal locking lever in direction indicated by LOCK. The yellow plastic safety lever lock can then be snapped onto the locking lever; this will prevent vibration or maintenance actions from releasing the contact from the operator.

PCB Mounting

Being able to separate the contacts from the operator allows for assembly of the front panel components (operator and lens) to be performed in tandem with the PC board assembly and soldering. For applications where multiple rows of push-buttons are mounted closely together, or where other components may obstruct access to the contact locking lever, be sure to include access holes in the PC board (refer to PC board layout dimensions for location). Also be sure to allow for space above and to the side of contact to ensure that no components block the contact block locking lever. PC board pins are designed to rest on the PCB, take this into consideration to ensure that pins do not short closely spaced traces.

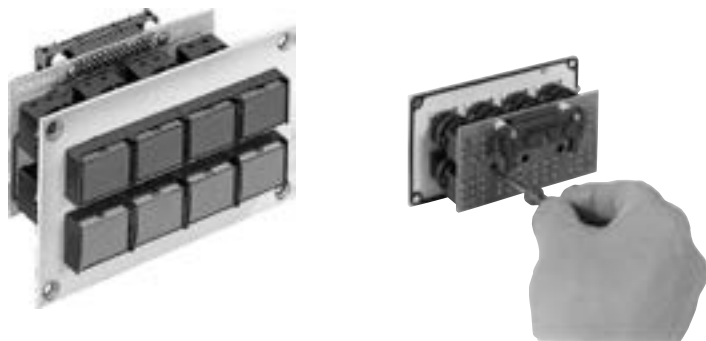

LBW Flush Mount 22mm Switches & Pilot Lights

Flush bezel projects only 2mm from front of panel. Removable contact blocks are ideal for single board mounting.

Key Features

- Pushbuttons, illuminated pushbuttons, selector switches, and key selector switches with up to 3PDT contacts.
- Key selectors with keys that are difficult to duplicate. Seven different key numbers to choose from.
- Pilot lights with round or square flat lenses.
- Solder / Tab or PC Board terminal.
- Black or metallic flush bezels available.
- Guard pushbuttons, illuminated or non-illuminated are available.
- Illuminated pushbuttons with bright, clear, ring, flush or extended lens.
- Choice of either gold-clad or silver contacts.
- Degree of protection: IP65 (from the front of the panel).



Applicable Standards	Mark	File No. or Organization
UL508		UL Recognition No.E55996
CSA 22.2 No.14		CSA File No. LR 21451
EN60947-5-1		TÜV Rheinland
		EU Low Voltage Directive
GB14048.5		

Specifications

Operating Temperature	-25 to +60°C (no freezing), Illuminated units: -25 to +55°C
Storage Temperature	-30 to +80°C (no freezing)
Operating Humidity	45 to 85% RH (no condensation)
Contact Resistance	50 mW maximum (initial value)
Insulation Resistance	100 MW minimum (500V DC megger)
Dielectric Strength	Switch Between live part and ground: 2,000V AC, 1 min. Between terminals of different poles: 2,000V AC, 1 min. Between terminals of the same poles: 1,000V AC, 1 min.
	Illumination Between live part and ground: 2,000V AC, 1 min.
Vibration Resistance	Operating extremes/Damage limits: 5 to 55 Hz, amplitude 0.5mm
Shock Resistance	Operating extremes: 100 m/s ² Damage limits: 1,000 m/s ²
Mechanical Life (minimum operations)	Momentary: 2,000,000 Maintained: 250,000 Selector switches: 250,000 Key selector switches: 250,000
Electrical Life (minimum operations)	Momentary: 50,000 / 100,000 ¹ Maintained: 50,000 / 100,000 ² Selector switches: 50,000 / 100,000 ² Key selector switches: 50,000 / 100,000 ²
Degree of Protection	IP65 (IEC 60529)
Terminal Style	Solder/tab terminal #110, PC board terminal
Bezel	Black plastic or metallic
Weight (approx.)	16g (illuminated pushbutton)
	14g (pilot light)
	15g (pushbutton)
	17g (selector switch)
	29g (key switch)
	17g (illuminated pushbutton with guard) 18g (push button with guard)

1. Switching frequency 1,800 operations/h.
2. Switching frequency 1,200 operations/h.

Contact Ratings

Gold Contact (switch base color: blue)			
Rated Insulation Voltage	250V		
Rated Thermal Current	3A		
Rated Operating Voltage	30V DC	125V AC	
Rated Operating Current (resistive load)	0.1A	0.1A	
Contact Material	Gold-clad silver		

Minimum applicable load (reference value): 5V AC/DC, 1 mA

Silver Contact (switch base color: gray)					
Rated Insulation Voltage	250V				
Rated Operating Voltage	30V	125V	250V		
Rated Operating Current	AC 50/60Hz	Resistive load	—	5A	5A
		Inductive load	—	3A	1.5A
	DC	Resistive load	5A	1.1A	—
		Inductive load	2.5A	0.55A	—
	AC 50/60Hz	Resistive load	—	5A	3A
		Inductive load	—	3A	1.5A
DC	Resistive load	3A	0.6A	—	
	Inductive load	1A	0.22A	—	
Rated Thermal Current	5A				
Contact Material	Silver				

AC inductive load: PF=0.6 to 0.7 DC inductive load: L/R=7 ms max.

LED Ratings

Rated Voltage	5V DC	12V AC/DC	24V AC/DC
Voltage Range	5V DC±5%	12V AC/DC±10%	24V AC/DC ±10%
LED Part No.	LB9Z-LED5②	LB9Z-LED1②	LB9Z-LED2②

Rated Current	A, R: 22 mA G, PW, S: 16 mA
Voltage Rating	Marked on the side of the LED unit
LED Life (reference value)	Approx. 30,000 hours (until the brightness reduces to 50% of the initial value)

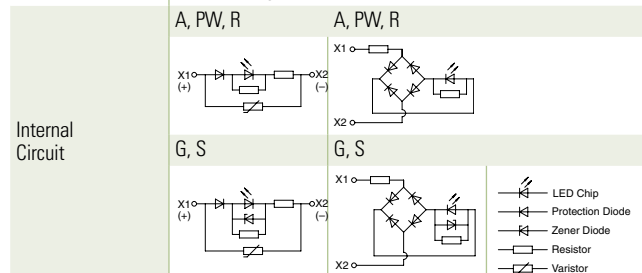

1. For ② (color code): A (amber), G (green), PW (white), R (red), S (blue)
2. Use the white LED for yellow illumination.
3. LED lamp contains a current-limiting resistor.

Switches & Pilot Devices

Signalming Lights

Relays & Sockets

Timers

Contactors

Terminal Blocks

Circuit Breakers

Illuminated Pushbuttons (Assembled)

LBW ① L - ② ③ T ④ ⑤ ⑥ *

Flush



Round / Black Bezel Square / Black Bezel Round / Metallic Bezel Square / Metallic Bezel Round with Guard Square with Guard

Extended



(black bezel is also available)

Flush Ring-illuminated



(black bezel is also available)

① Style	② Operation	④ Contact	⑤ LED Operating Voltage	Part No.	* Illumination Color Code
Black bezel	Momentary	Gold/SPDT	24V AC/DC	LBW①L-M③T14*	Specify the color code in place of * in the Part No. A: amber G: green PW: pure white R: red S: blue Y: yellow
		Gold/DPDT		LBW①L-M③T24*	
	Maintained	Gold/SPDT	24V AC/DC	LBW①L-A③T14*	
		Gold/DPDT		LBW①L-A③T24*	
Metallic bezel	Momentary	Gold/SPDT	24V AC/DC	LBW①L-M③T14*	
		Gold/DPDT		LBW①L-M③T24*	
	Maintained	Gold/SPDT	24V AC/DC	LBW①L-A③T14*	
		Gold/DPDT		LBW①L-A③T24*	
Guard Type	Momentary	Gold/SPDT	24V AC/DC	LBW①L-M③T14*	
		Gold/DPDT		LBW①L-M③T24*	
	Maintained	Gold/SPDT	24V AC/DC	LBW①L-A③T14*	
		Gold/DPDT		LBW①L-A③T24*	

- Flush/Extended color code: A (amber), G (green), PW (pure white), R (red), S (blue), Y (yellow)
- Ring-illuminated color code: PW (pure white), WA (amber), WG (green), WR (red), WS (blue)
- Illuminated pushbuttons contain an LED unit. For details on LED units, see 580.
- The guard opens 180 degrees spring-return.
- Illuminated pushbuttons can be used with legend markings. Engraving can be done on a marking plate which is placed in the lens, or a clear film can be printed and placed in the lens. See 594 for details on the marking plate and film.
- White lens type (when light is off) are available. Clear lens is used instead of colored lens for amber, green, red, and blue illuminated pushbuttons. Amber, green, red, or blue LED units are used. To specify, see Part Number Interpretation below.
- PC board terminals available for gold contacts. Silver contacts also available. To specify, see Part Number Interpretation below.
- Extended style is available. See Part Number Interpretation below (③).
- Flush ring-illuminated style is available. See Part Number Interpretation below (③). Guard is not available with flush ring-illuminated style.
- 5V DC and 12V AC/DC LED operating voltages also available.
- Marking plates are available. See accessory section.

Part Number Interpretation

LBW ① L - ② ③ T ④ ⑤ ⑥ *



To be used for interpreting part numbers only, not for part number development.

① Style

Code	Shape
6	Round / Black Bezel
7	Square / Black Bezel
6M	Round / Metallic Bezel
7M	Square / Metallic Bezel
6G	Round with Guard
7G	Square with Guard

② Operation

Code	Operation
A	Maintained
M	Momentary

③ Operator Style

Code	Operator Style
1	Flush
2	Extended
1R	Flush Ring-illuminated

* Extended style is available only for round (black/metallic bezel) and in momentary operation. Guard model is not available.

④ Contacts

Code	Contact
1	Gold/SPDT
2	Gold/DPDT
5	Silver/SPDT
6	Silver/DPDT

⑤ LED Operating Voltage

Code	Rated Operating Voltage
1	5V DC
3	12V AC/DC
4	24V AC/DC

⑥ Others

Code	Specification	Part No. Example
Blank	Solder/Tab Terminal	—
V	PC Board Terminal (Gold Contact Only)	LBW6L-M1T14V*

• Specify the color code in place of * in the table above.

Illuminated Pushbuttons (Sub-assembled)



Contact Block

Terminal Style	Material	Contact	Part Number
	Silver	SPDT	LB-T50
		DPDT	LB-T60
	Gold	SPDT	LB-T10V
		DPDT	LB-T20V

LED Module

Style	Color	Voltage	Part Number
	Amber	5V	LB9Z-LED5A
		12V	LB9Z-LED1A
		24V	LB9Z-LED2A
	Green	5V	LB9Z-LED5G
		12V	LB9Z-LED1G
		24V	LB9Z-LED2G
	Red	5V	LB9Z-LED5R
		12V	LB9Z-LED1R
		24V	LB9Z-LED2R
	Blue	5V	LB9Z-LED5S
		12V	LB9Z-LED1S
		24V	LB9Z-LED2S
	Pure White	5V	LB9Z-LED5PW
		12V	LB9Z-LED1PW
		24V	LB9Z-LED2PW

Operator

Style	Mounting Style	Shape	Momentary	Maintained
	Flush Mount (Plastic)	Round	LBW6L-M0	LBW6L-A0
		Square	LBW7L-M0	LBW7L-A0
	Flush Mount (Metallic)	Round	LBW6ML-M0	LBW6ML-A0
		Square	LBW7ML-M0	LBW7ML-A0
	Flush Mount (Built-in switch guard)	Round	LBW6GL-M0	LBW6GL-A0
		Square	LBW7GL-M0	LBW7GL-A0
	Flush Mount (Plastic)	Round (for extended lens)	LBW6L-M20	LBW6L-A20
			Flush Mount (Metallic)	LBW6ML-M20

Lens

Shape	Color	Part Number
	Amber	LBW6A-L1A
	Green	LBW6A-L1G
	Red	LBW6A-L1R
	Blue	LBW6A-L1S
	White	LBW6A-L1W
	Yellow	LBW6A-L1Y
	Amber	LBW6A-L2A
	Green	LBW6A-L2G
	Red	LBW6A-L2R
	Blue	LBW6A-L2S
	White	LBW6A-L2W
	Yellow	LBW6A-L2Y
	Amber	LBW7A-L1A
	Green	LBW7A-L1G
	Red	LBW7A-L1R
	Blue	LBW7A-L1S
	White	LBW7A-L1W
	Yellow	LBW7A-L1Y
Round Ring Flush	White	LBW6A-L1R-W
Square Ring Flush	White	LBW7A-L1R-W

Note: No marking plate used in ring illuminated pushbuttons.

Dimensions

All dimensions in mm.

Flush/Ring-illuminated

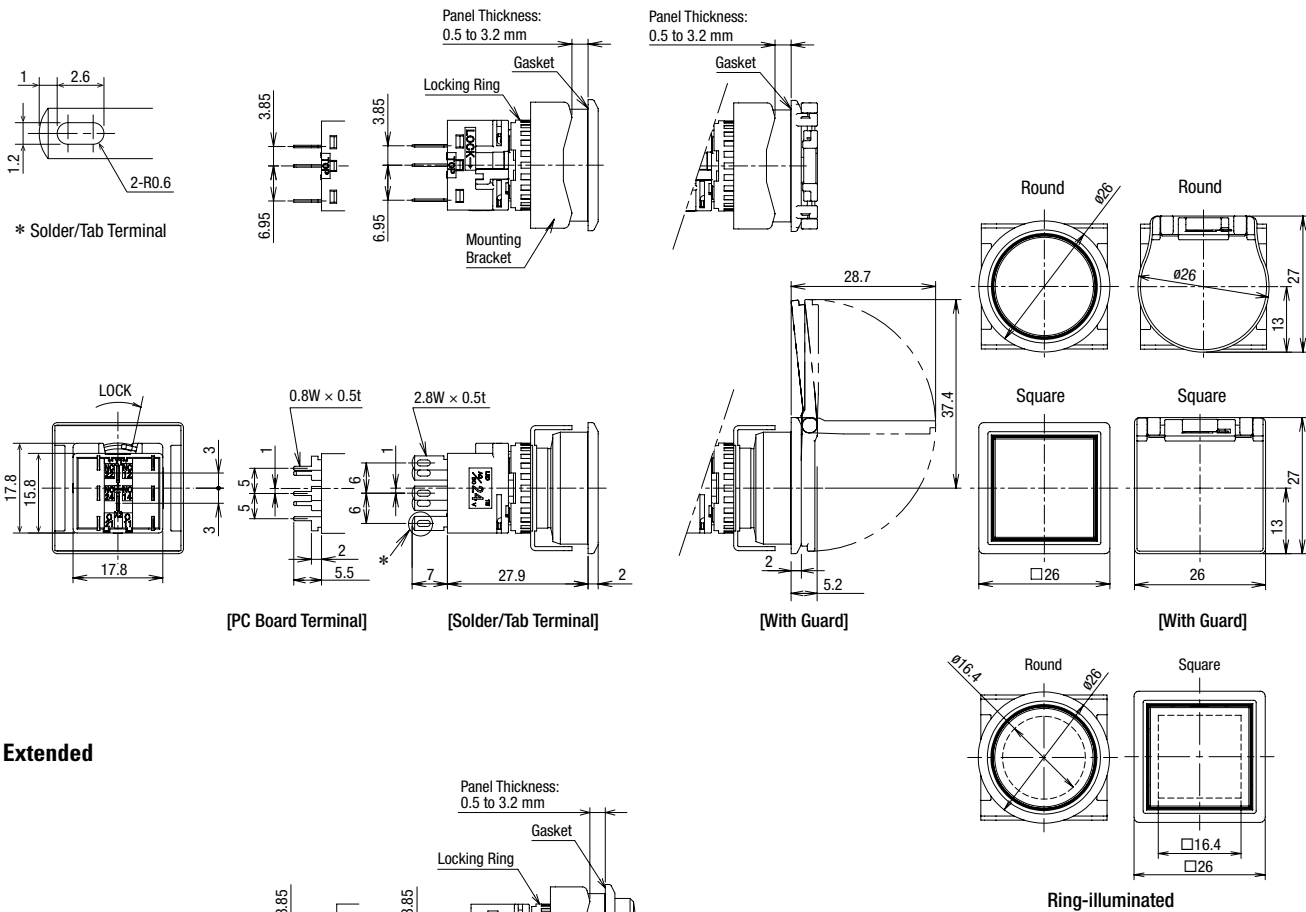

Extended

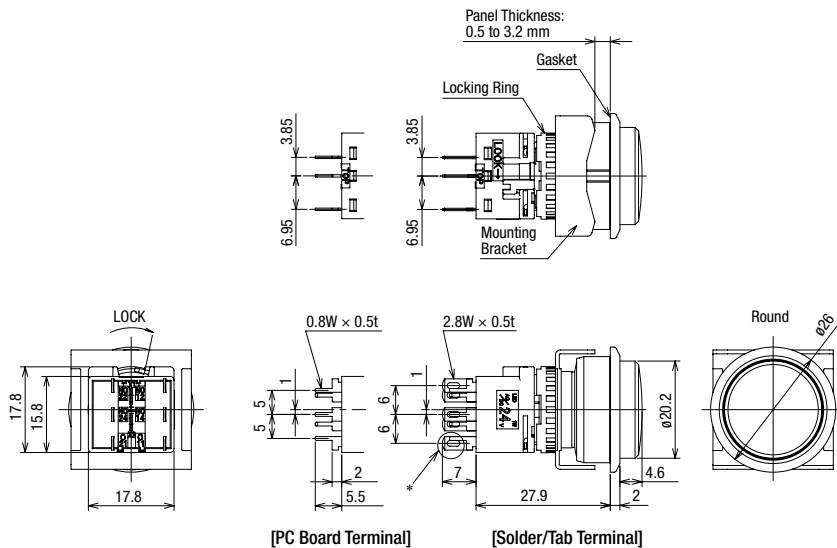

Terminal Arrangement (Bottom View)

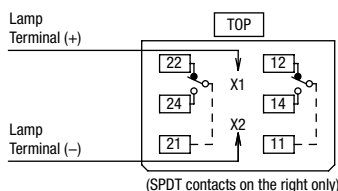

- For details on pc board and circuit design, see 594.
- For details on single board mounting, see 593.

Pilot Lights

LBW①P-1T0②③*

Part No.



Round / Black Bezel



Square / Black Bezel



Round / Metallic Bezel



Square / Metallic Bezel

① Style	③ LED Operating Voltage	Part No.	* Illumination Color Code
Black Bezel	24V AC/DC	LBW①P-1T04*	Specify the color code in place of * in the Part No. A: amber G: green PW: pure white R: red S: blue Y: yellow
Metallic Bezel	24V AC/DC	LBW①P-1T04*	

- Pilot lights contain an LED unit. For maintenance LED units see **583**.
- Legends and symbols can be engraved on a marking plate or film to be inserted under the lens by users for labelling purposes. See **596** for details.
- White lens type (when light is off) are available. Clear lens is used instead of colored lens for amber, green, red, and blue pilot lights. Amber, green, red, or blue LED units are used. To specify, see Part Number Interpretation below.
- PC board terminals available. To specify, see Part Number Interpretation below.
- 5V DC and 12V AC/DC LED operating voltages also available.

Part Number Interpretation

LBW①P-1T0②③*



To be used for interpreting part numbers only, not for part number development.

① Style

Code	Shape
6	Round / Black Bezel
7	Square / Black Bezel
6M	Round / Metallic Bezel
7M	Square / Metallic Bezel

② LED Operating Voltage

Code	Rated Operating Voltage
1	5V DC
3	12V AC/DC
4	24V AC/DC

③ Others



Code	Specification	Part No. Example
Blank	Solder/Tab Terminal	—
V	PC Board Terminal	LBW6P-1T04V*

- Specify the color code in place of * in the table above.

Pilot Lights (Sub-assembled)





Contact Block

Terminal Style	Part Number
 Solder Tab	LB-T00
 PCB	LB-T00V



LED Module

Style	Color	Voltage	Part Number
	Amber	5V	LB9Z-LED5A
		12V	LB9Z-LED1A
		24V	LB9Z-LED2A
Green	5V	LB9Z-LED5G	
	12V	LB9Z-LED1G	
	24V	LB9Z-LED2G	
Red	5V	LB9Z-LED5R	
	12V	LB9Z-LED1R	
	24V	LB9Z-LED2R	
Blue	5V	LB9Z-LED5S	
	12V	LB9Z-LED1S	
	24V	LB9Z-LED2S	
Pure White	5V	LB9Z-LED5PW	
	12V	LB9Z-LED1PW	
	24V	LB9Z-LED2PW	

Operator

Style	Mounting Style	Shape	Part Number
	Flush Mount (Plastic)	Round	LBW6P-0
		Square	LBW7P-0
	Flush Mount (Metallic)	Round	LBW6MP-0
		Square	LBW7MP-0

Lens

Shape	Color	Part Number
	Amber	LBW6A-P1A
	Green	LBW6A-P1G
	Red	LBW6A-P1R
	Blue	LBW6A-P1S
	White	LBW6A-P1W
	Yellow	LBW6A-P1Y
	Amber	LBW7A-P1A
	Green	LBW7A-P1G
	Red	LBW7A-P1R
	Blue	LBW7A-P1S
	White	LBW7A-P1W
	Yellow	LBW7A-P1Y

Dimensions

All dimensions in mm.

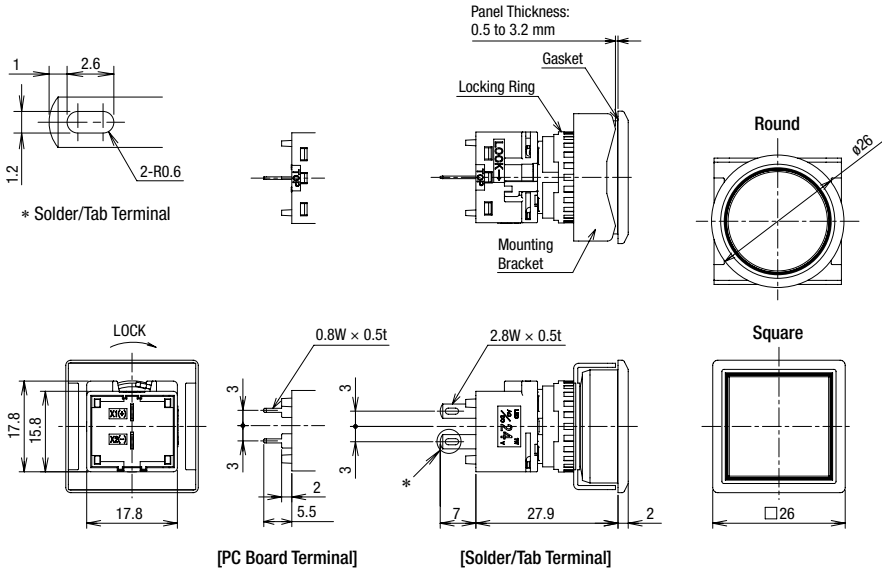

Terminal Arrangement (Bottom View)

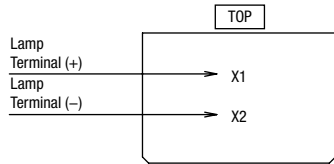

Pushbuttons

LBW①B-②③T④⑤*

Flush



Round / Black Bezel



Square / Black Bezel



Round / Metallic Bezel



Square / Metallic Bezel



Round with Guard



Square with Guard

Extended



Round only (metallic bezel available)

① Style	② Operation	③ Button Shape	Part No.	* Illumination Color Code
Black bezel	Momentary	Flush Round	LBW6B-M1T1④⑤	Specify the color code in place of * in the Part No. B: black G: green R: red S: blue W: white Y: yellow
		Flush Square	LBW7B-M1T1④⑤	
		Extended Round	LBW6B-M1T2④⑤	
	Maintained	Flush Round	LBW6B-A1T1④⑤	
		Flush Square	LBW7B-A1T1④⑤	
		Extended Round	LBW6B-A1T2④⑤	
Metallic bezel	Momentary	Flush Round	LBW6MB-M1T1④⑤	
		Flush Square	LBW7MB-M1T1④⑤	
		Extended Round	LBW6MB-M1T2④⑤	
	Maintained	Flush Round	LBW6MB-A1T1④⑤	
		Flush Square	LBW7MB-A1T1④⑤	
		Extended Round	LBW6MB-A1T2④⑤	
Guard Type	Momentary	Flush Round	LBW6GB-M1T1④⑤	
		Flush Square	LBW7GB-M1T1④⑤	
	Maintained	Flush Round	LBW6GB-A1T1④⑤	
		Flush Square	LBW7GB-A1T1④⑤	

- The guard opens 180 degrees spring-return.
- PC board terminals available for gold contacts. To specify, see Part Number Interpretation below.
- Pushbuttons can be used with legend markings engraved on marking plates and lens buttons with clear film inserted in the lens is available. To specify, see Part Number Interpretation below. See for details on the marking plate and film.
- Extended pushbuttons available. To specify, see Part Number Interpretation below. Pushbuttons with guard is not available. Extended pushbuttons is available with momentary operation only.

Part Number Interpretation

LBW①B-②③T④⑤*



To be used for interpreting part numbers only, not for part number development.

① Style

Code	Shape
6	Round / Black Bezel
7	Square / Black Bezel
6M	Round / Metallic Bezel
7M	Square / Metallic Bezel
6G	Round with Guard
7G	Square with Guard

② Operation

Code	Operation
A	Maintained
M	Momentary

③ Operator Style

Code	Operation
1	Flush
2	Extended *

* Extended style is available only for round (black/metallic bezel) and in momentary operation. Guard model is not available.

④ Contacts

Code	Contact	Code	Contact
1	Gold/SPDT	5	Silver/SPDT
2	Gold/DPDT	6	Silver/DPDT
3	Gold/3PDT	7	Silver/3PDT

⑤ Others

Code	Specification	Part No. Example
Blank	Solder/Tab Terminal	—
L (Note 1)	Lens	LBW6B-M1T1L*
V	PC Board Terminal (Gold Contact Only)	LBW6B-M1T1V*
VL (Note 1)	PC Board Terminal with Lens (Gold Contact Only)	LBW6B-M1T1VL*

Note 1: Codes L and VL are available with flush operator only.

- Color code (*) for lens:
A (amber), B (translucent lens with black nameplate), G (green), R (red), S (blue), W (white), Y (yellow)

Pushbuttons (Sub-assembled)



Contact Block

Terminal Style	Material	Contact	Part Number
	Silver	SPDT	LB-T5
		DPDT	LB-T6
		3PDT	LB-T7
	Gold	SPDT	LB-T1V
		DPDT	LB-T2V
		3PDT	LB-T3V

Operator

Style	Bezel Style	Shape	Momentary	Maintained
	Black plastic bezel	Round	LBW6L-M0	LBW6L-A0
		Square	LBW7L-M0	LBW7L-A0
	Metallic bezel	Round	LBW6ML-M0	LBW6ML-A0
		Square	LBW7ML-M0	LBW7ML-A0
	Plastic bezel with built-in switch guard	Round	LBW6GL-M0	LBW6GL-A0
		Square	LBW7GL-M0	LBW7GL-A0
	Flush Mount (Plastic)	Round (for extended lens)	LBW6L-M20	LBW6L-A20
	Flush Mount (Metallic)		LBW6ML-M20	LBW6ML-A20

Button

Style	Color	Part Number
	Black	LBW6A-B1B
	Green	LBW6A-B1G
	Red	LBW6A-B1R
	Blue	LBW6A-B1S
	White	LBW6A-B1W
	Yellow	LBW6A-B1Y
	Black	LBW6A-B2B
	Green	LBW6A-B2G
	Red	LBW6A-B2R
	Blue	LBW6A-B2S
	White	LBW6A-B2W
	Yellow	LBW6A-B2Y
	Black	LBW7A-B1B
	Green	LBW7A-B1G
	Red	LBW7A-B1R
	Blue	LBW7A-B1S
	White	LBW7A-B1W
	Yellow	LBW7A-B1Y

Dimensions

All dimensions in mm.

Flush Pushbutton

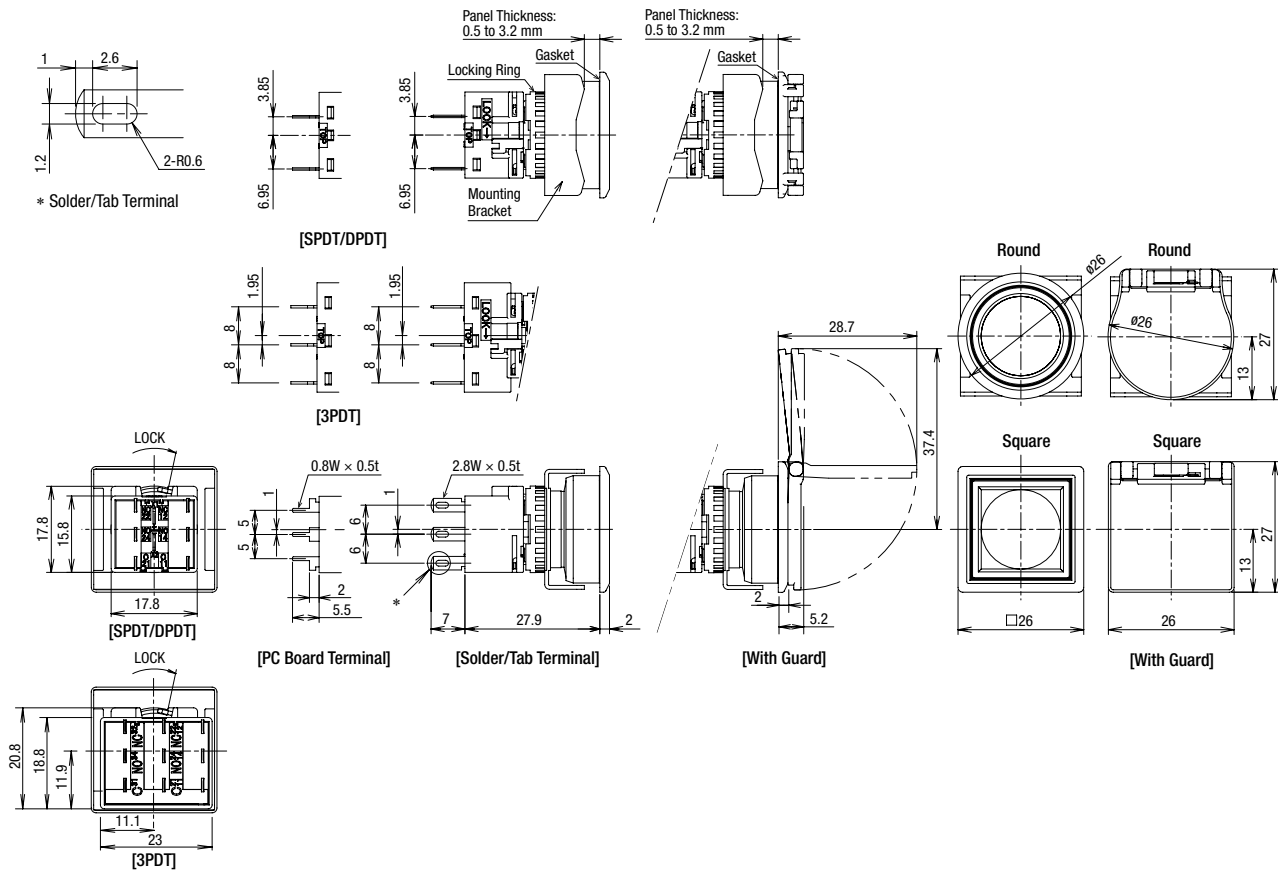

Extended Pushbutton

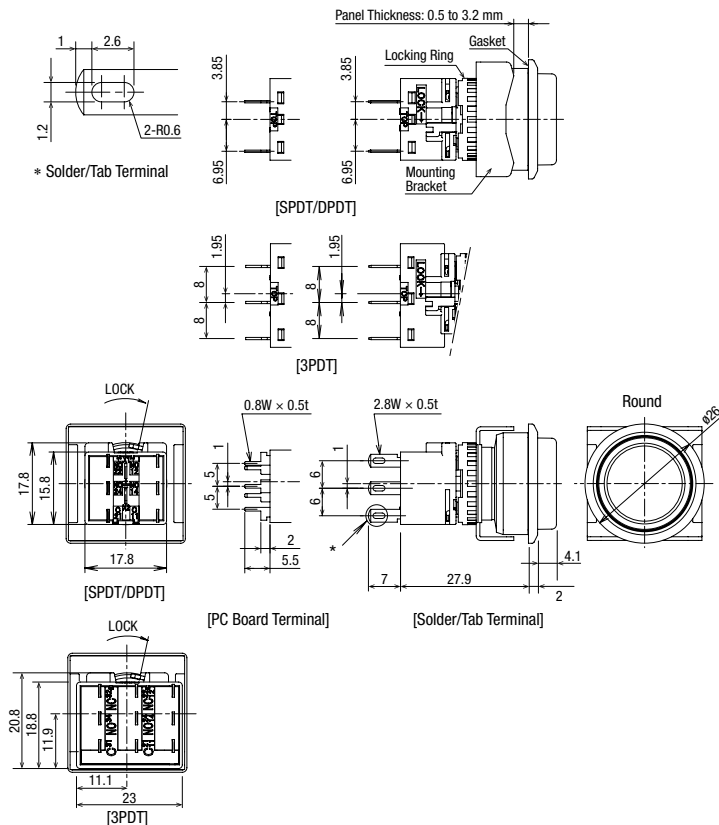

Terminal Arrangement (Bottom View)

SPDT/DPDT Contacts

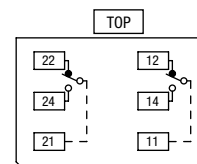





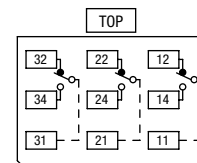

(SPDT contacts on the right only)

3PDT Contacts



- For details on mounting hole layout, see 593.
- For details on pc board and circuit design, see 594.
- For details on single board mounting, see 593.

Selector Switches

Part No.	LBW①S-②T③④						
				Round / Black Bezel	Square / Black Bezel	Round / Metallic Bezel	Square / Metallic Bezel
	① Style	② Operator Position		③ Contact	Part No.		
					Gold Contact	Silver Contact	
	Black bezel	90° 2-position	Maintained		SPDT	LBW①S-2T1	LBW①S-2T5
DPDT					LBW①S-2T2	LBW①S-2T6	
3PDT					LBW①S-2T3	LBW①S-2T7	
45° 3-position		Maintained		DPDT	LBW①S-3T2	LBW①S-3T6	
				3PDT	LBW①S-3T3	LBW①S-3T7	
				Spring return two-way	DPDT	LBW①S-33T2	LBW①S-33T6
			3PDT	LBW①S-33T3	LBW①S-33T7		
Metallic bezel	90° 2-position	Maintained		SPDT	LBW①S-2T1	LBW①S-2T5	
				DPDT	LBW①S-2T2	LBW①S-2T6	
				3PDT	LBW①S-2T3	LBW①S-2T7	
	45° 3-position	Maintained		DPDT	LBW①S-3T2	LBW①S-3T6	
				3PDT	LBW①S-3T3	LBW①S-3T7	
				Spring return two-way	DPDT	LBW①S-33T2	LBW①S-33T6
			DPDT	LBW①S-33T3	LBW①S-33T7		

- PC board terminals available for gold contacts. To specify, see Part Number Interpretation below.
- For contact operation, see 556.

Part Number Interpretation

LBW①S-②T③④



To be used for interpreting part numbers only, not for part number development.

① Style

Code	Shape
6	Round / Black Bezel
7	Square / Black Bezel
6M	Round / Metallic Bezel
7M	Square / Metallic Bezel

② Operator Position

2-position

Operator Position

2 Maintained



3-position

Operator Position

3 Maintained



33 Spring return two-way



③ Contacts

Code	Contact
1	Gold/SPDT (90° 2-position only)
2	Gold/DPDT
3	Gold/3PDT
5	Silver/SPDT (90° 2-position only)
6	Silver/DPDT
7	Silver/3PDT

④ Others

Code	Specification	Part No. Example
Blank	Solder/Tab Terminal	—
V	PC Board Terminal (Gold Contact Only)	LBW6S-2T1V

Selector Switches (Sub-assembled)

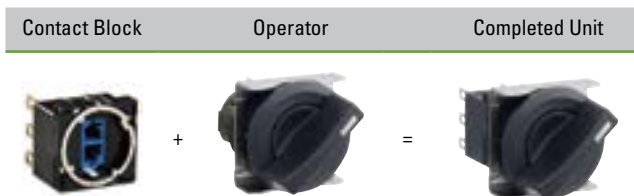

Contact Block

Terminal Style	Material	Contact	Part Number	
	Solder/Tab	Silver	SPDT	LB-T5
			DPDT	LB-T6
			3PDT	LB-T7
	PCB	Gold	SPDT	LB-T1V
			DPDT	LB-T2V
			3PDT	LB-T3V

SPDT contacts applicable for 2-position switches only.

Operator

Style	Shape	Position	Function	Part Number
 Round	Round	2	Maintained	LBW6S-2Y
		3	Maintained	LBW6S-3Y
			Spring from both	LBW6S-33Y
 Square	Square	2	Maintained	LBW7S-2Y
		3	Maintained	LBW7S-3Y
			Spring from both	LBW7S-33Y
 Round	Round	2	Maintained	LBW6MS-2Y
		3	Maintained	LBW6MS-3Y
			Spring from both	LBW6MS-33Y
 Square	Square	2	Maintained	LBW7MS-2Y
		3	Maintained	LBW7MS-3Y
			Spring from both	LBW7MS-33Y

Key Selector Switches

Part No.	LBW ① K - ② ③ T ④ ⑤ - ⑥						
	Wave Key				Disc Tumbler Key		
	Round / Black Bezel	Square / Black Bezel	Round / Metallic Bezel	Square / Metallic Bezel	Round / Metallic Bezel	Square / Metallic Bezel	
① Style	② Operator Position		⑤ Key Removable Position	⑥ Contact	Part No.		
					Gold Contact	Silver Contact	
Black bezel	90° 2-position	Maintained	A: Key removable in all positions		SPDT	LBW ① K -2 ST 1 A	LBW ① K -2 ST 5 A
					DPDT	LBW ① K -2 ST 2 A	LBW ① K -2 ST 6 A
	45° 3-position	Maintained	A: Key removable in all positions		DPDT	LBW ① K -3 ST 2 A	LBW ① K -3 ST 6 A
					3PDT	LBW ① K -3 ST 3 A	LBW ① K -3 ST 7 A
Metallic bezel	90° 2-position	Maintained	A: Key removable in all positions		SPDT	LBW ① K -2 ST 1 A	LBW ① K -2 ST 5 A
					DPDT	LBW ① K -2 ST 2 A	LBW ① K -2 ST 6 A
	45° 3-position	Maintained	A: Key removable in all positions		DPDT	LBW ① K -3 ST 2 A	LBW ① K -3 ST 6 A
					3PDT	LBW ① K -3 ST 3 A	LBW ① K -3 ST 7 A

- For operator position, see Part Number Interpretation below.
- For key removable position, see Part Number Interpretation below. The key cannot be removed in a spring returned position.
- Two keys are supplied.
- Besides the standard key (key number 0H), six other keys are available.
- Disc tumbler keys also available. Only the standard key is available. To specify, see Part Number Interpretation below.
- PC board terminals available for gold contacts. To specify, see Part Number Interpretation below.
- For contact operation, see **593**.

Part Number Interpretation

LBW ① **K** - ② ③ **T** ④ ⑤ - ⑥



To be used for interpreting part numbers only, not for part number development.

① Style

Code	Shape
6	Round / Black Bezel
7	Square / Black Bezel
6M	Round / Metallic Bezel
7M	Square / Metallic Bezel

② Operator Position

Code	Operator Position
2	90° 2-position maintained
3	45° 3-position maintained
33	45°-3-position spring return two-way

③ Key Style

Code	Key Style
S	Wave key
Blank	Disc tumbler key

④ Contacts

Code	Contact
1	Gold/SPDT (90° 2-position only)
2	Gold/DPDT
3	Gold/3PDT
5	Silver/SPDT (90° 2-position only)
6	Silver/DPDT
7	Silver/3PDT

⑤ Key Removal Position

2-position

Key Removable Position

A: Key removable in all positions	B: Key removable at left position only

3-position

Key Removable Position

A: Key removable in all positions	D: Key removable at center only

⑥ Key Number (for wave keys only)

Code	
0H or Blank	Standard key
1H to 2H	Reversible key
3H to 6H	Non-reversible key

Others

Code	Specification	Part No. Example
Blank	Solder/Tab Terminal	—
V	PC Board Terminal (Gold Contact Only)	LBW 6 K -2 T 1 V A

3-position

Spring return two-way

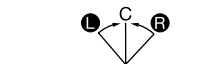

- Key removable at L, C, R.
- Key retained at L, R.

Key Selector Switches (Sub-assembled)

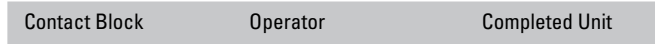

Contact Block

Terminal Style	Material	Contact	Part Number	
	Solder/Tab	Silver	SPDT	LB-T5
			DPDT	LB-T6
			3PDT	LB-T7
	PCB	Gold	SPDT	LB-T1V
			DPDT	LB-T2V
			3PDT	LB-T3V

Operator

Style	Shape	Position	Function	Key Style	Key Remove Position	Part number
	Round	2	90° 2-position maintained	Disc tumbler key	All positions	LBW6K-2A
					Left	LBW6K-2B
		Wave key	All positions	LBW6K-2SA		
			Left	LBW6K-2SB		
		3	45° 3-position maintained	Disc tumbler key	All positions	LBW6K-3A
					Center	LBW6K-3D
	Wave key	All positions	LBW6K-3SA			
		Center	LBW6K-3SD			
	3	45°-3-position spring return two-way	Disc tumbler key	All positions	LBW6K-33D	
			Wave key	Center	LBW6K-33SD	
	Square	2	90° 2-position maintained	Disc tumbler key	All positions	LBW7K-2A
					Left	LBW7K-2B
Wave key			All positions	LBW7K-2SA		
			Left	LBW7K-2SB		
3			45° 3-position maintained	Disc tumbler key	All positions	LBW7K-3A
					Center	LBW7K-3D
Wave key		All positions	LBW7K-3SA			
		Center	LBW7K-3SD			
3		45°-3-position spring return two-way	Disc tumbler key	Center	LBW7K-33D	
			Wave key	Center	LBW7K-33SD	

Style	Shape	Position	Function	Key Style	Key Remove Position	Part number
	Round	2	90° 2-position maintained	Disc tumbler key	All positions	LBW6MK-2A
					Left	LBW6MK-2B
		Wave key	All positions	LBW6MK-2SA		
			Left	LBW6MK-2SB		
		3	45° 3-position maintained	Disc tumbler key	All positions	LBW6MK-3A
					Center	LBW6MK-3D
	Wave key	All positions	LBW6MK-3SA			
		Center	LBW6MK-3SD			
	3	45°-3-position spring return two-way	Disc tumbler key	Center	LBW6MK-33D	
			Wave key	Center	LBW6MK-33SD	
	Square	2	90° 2-position maintained	Disc tumbler key	All positions	LBW7MK-2A
					Left	LBW7MK-2B
Wave key		All positions	LBW7MK-2SA			
		Left	LBW7MK-2SB			
3		45° 3-position maintained	Disc tumbler key	All positions	LBW7MK-3A	
				Center	LBW7MK-3D	
Wave key	All positions	LBW7MK-3SA				
	Center	LBW7MK-3SD				
3	45°-3-position spring return two-way	Disc tumbler key	Center	LBW7MK-33D		
		Wave key	Center	LBW7MK-33SD		

Switches & Pilot Devices

Signaling Lights

Relays & Sockets

Timers

Contactors

Terminal Blocks

Circuit Breakers

Dimensions

All dimensions in mm.

Key Selector Switches with Wave Key

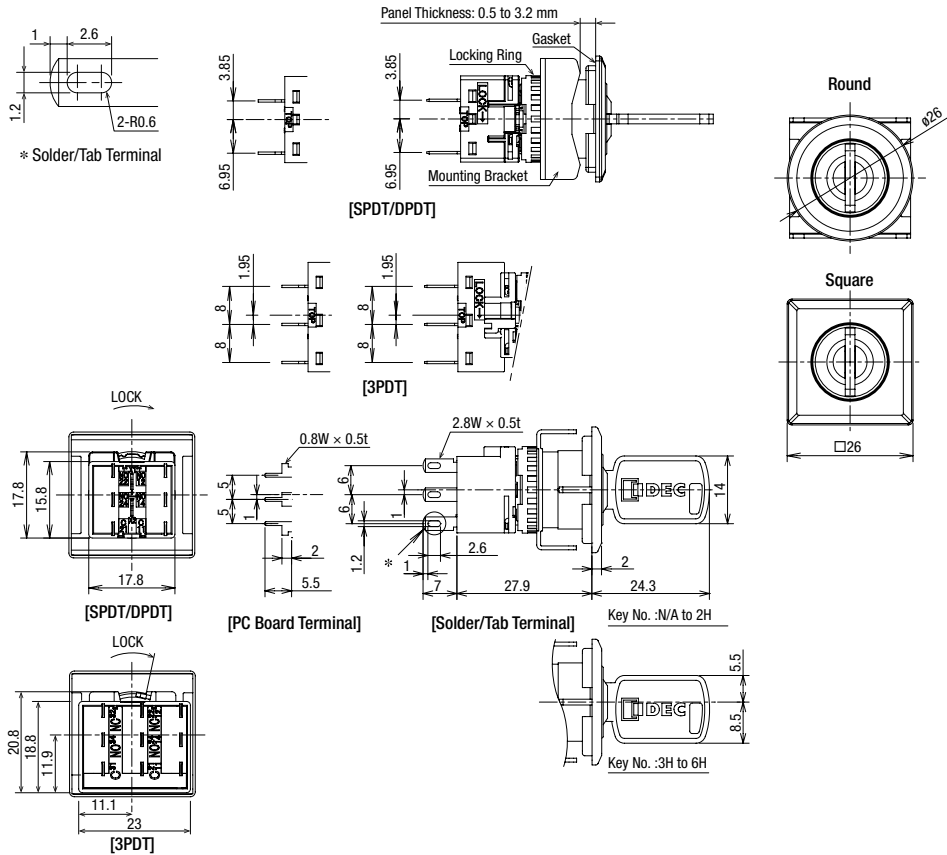

Key Selector Switches with Disc Tumbler Key

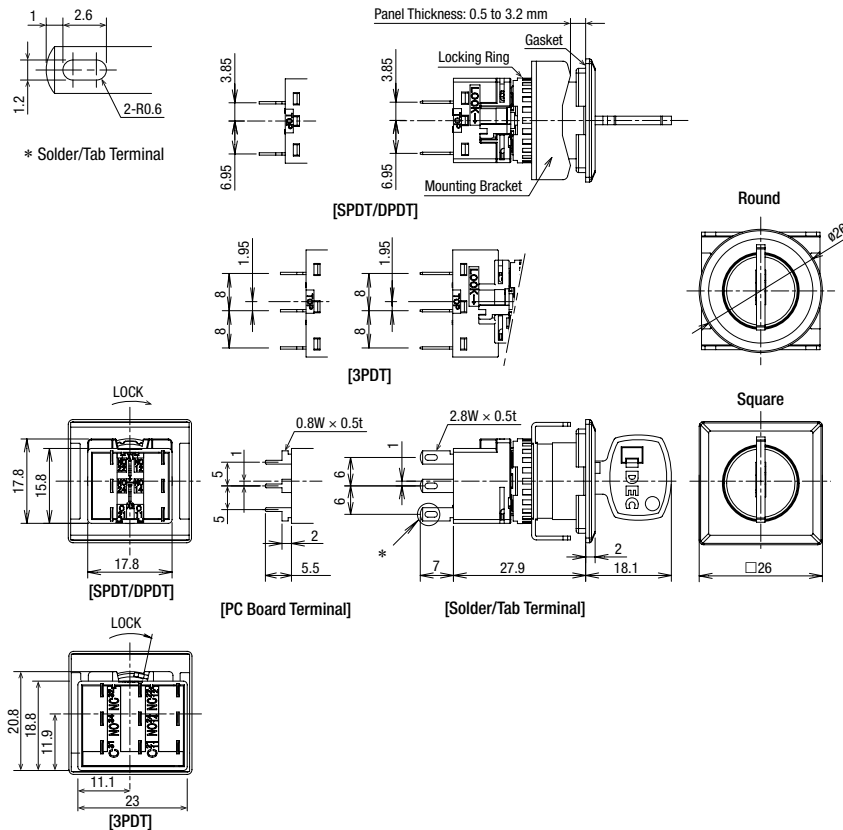

Terminal Arrangement (Bottom View)

SPDT/DPDT Contacts

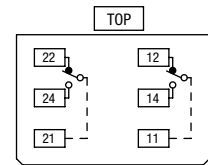

(SPDT contacts on the right only)

3PDT Contacts

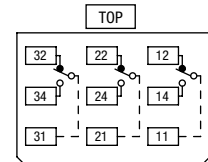

- For details on mounting hole layout, see **593**.
- For details on pc board and circuit design, see **594**.
- For details on single board mounting, see **593**.

Contact Operation

Selector Switch, Illuminated Selector Switch, Key Selector Switch

Operator Position & Contact Operation (Top View)								
Position		Contact	Left	Center	Right			
90° 2-position	<p>Maintained</p>	<p>Spring return from right</p>	SPDT					
			DPDT					
			3PDT					
45° 3-position	<p>Maintained</p>	<p>Spring return from right</p>	<p>Spring return from left</p>	<p>Spring return two-way</p>	DPDT			
					3PDT			

Mounting Hole Layout (mm)

LBW Series Flush Bezel (LBW6/LBW6M/LBW6G)

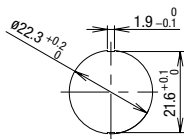

LBW Series Flush Bezel LBW6/LBW6M/LBW6G

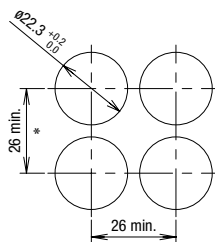

* 53 mm minimum for switches with guard

LBW Series Flush Bezel LBW7/LBW7M/LBW7G

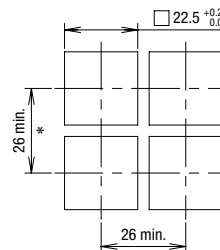

Single Board Mounting

IDEC's LBW Series is available for single board mounting.

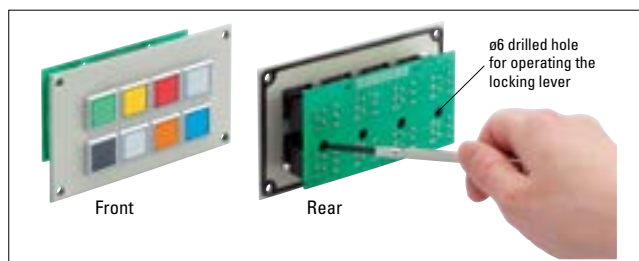

Assembly Procedure

1. Install the operator to the panel.
 2. Mount the contact block to the operator from the rear.
 3. Turn the locking lever to lock the contact block.
 4. Insert the PC board to terminals and solder.
- Note 1: Make sure that each terminal is inserted into the PC board correctly.
 Note 2: Do not apply tensile force to the connector cable for an extended period of time.
 Note 3: Do not expose the contact block to water.
 Note 4: Ensure to lock contact blocks when the contact blocks are installed on the operators. UP series can be installed on the same board. For details, see 599.

Installing and Removing Contact Blocks

Turn the locking lever to install and remove contact blocks on the PC using a screwdriver from a hole in the PC board. See "Notes for Designing PC Board and Circuit" on 594. Determine the location of the switches so that the locking lever can be operated. See "Removing and Installing the Contact Block" on 598.

Mounting Holes and Assembly Procedure

Drill mounting holes in the panel as shown below. When the units are mounted collectively, provide adequate clearance.

Notes for Designing PC Board and Circuit

All dimensions in mm.

- Use 1.6-mm-thick glass epoxy PC board with drilled holes.
- Design a circuit so that the LBW series can operate within the rated voltage and current range. Make sure that inrush current and voltage do not exceed the rating.
- Minimum applicable load is 5V AC/DC, 1 mA on gold contacts. Applicable range is subject to the operating condition and load.
- Since the ø2.8-mm-wide terminal touches the PC board as shown on the right, short circuit may occur with pattern lines. Design a circuit that prevents short circuits.

SPDT/DPDT Contacts

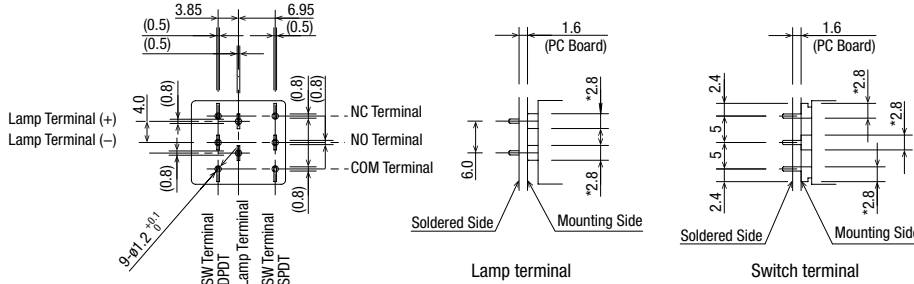

3PDT Contacts

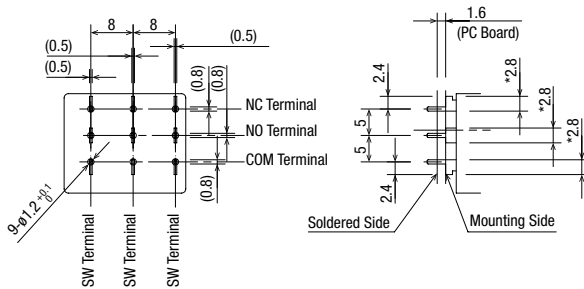

PC Board Drilling Layout (Bottom View)

SPDT/DPDT Contacts

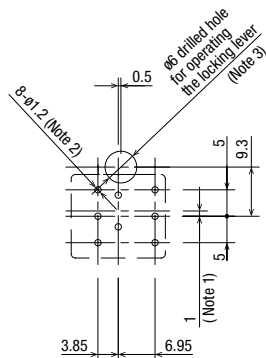

3PDT Contacts

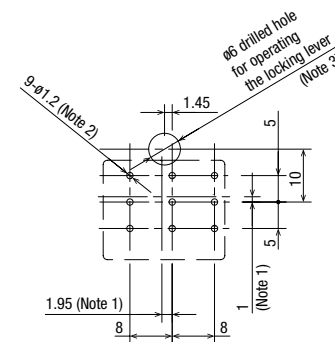

Note 1: When designing, note the alignment of center lines of the contact blocks and center lines of the operators.

Note 2: The diameter of the terminal hole is ø1.2.

Note 3: Hole diameter may vary to meet installation requirements. Determine the location and the size of the hole so that the locking lever can be operated.

Accessories

Shape	Specification	Part No.	Remarks		
Locking Ring Wrench 	Metal (Nickel-plated brass)	MT-001	Used to tighten the locking ring when installing the units on to the panel.		
For Standard Bezels Lens Removal Tool 	Stainless Steel	MT-101	Used to remove the lens or button. (for standard bezels)		
For LBW Series Flush Bezels Mounting Hole Plug  	1. For round units (LBW6/LBW6M) [Plug] Polyamide (Black)	LBW9Z-BS6*	* Color code: blank (black), W (white) Degree of protection: IP65 Panel thickness: 0.5 to 3.2 mm See 596 for dimensions.		
	2. For square units (LBW7/LBW7M) [Gasket] Nitrile rubber [Mounting Plate] Stainless Steel			LBW9Z-BS7*	
	Mounting Hole Plug 	Metal		LW9Z-BM	Degree of protection: IP66 Tightening torque: 1.2 N·m See 596 for dimensions.
	Mounting Hole Plug 	Rubber		LW9Z-BP1	Degree of protection: IP65 Tightening torque: 2.0 N·m See 596 for dimensions.
Terminal Cover  	1. For SPDT/DPDT contacts PBT (White)	LB9Z-VL2	See 596 for dimensions. See 598 for mounting.		
	2. For 3PDT contacts	LB9Z-VL3			
Key  Reversible key  Non-reversible key	For key selector switches (wave key) Metal (zinc nickel-plated)	LA9Z-SK-*	Specify a key number in place of * in the Part No. Blank: Standard key 0H (reversible) 1H to 2H: Reversible key 3H to 6H: Non-reversible key See 596 for dimensions.		
Keys 	For key selector switches (disc tumbler key) Metal (brass nickel-plated) 18×1.8×25.1 t1.8	AS6-SK-132			

Switches & Pilot Devices

Signaling Lights

Relays & Sockets

Timers

Contactors

Terminal Blocks

Circuit Breakers

Accessories

Shape		Material / Dimensions (W×H×D)	Part No.	Remarks
Lens 	1. For round flush units	Polyarylate ø20 H4	HA9Z-L11*	Specify the color code in place of * in the part no. A: Amber, C: Clear, G: Green, R: Red, S: Blue, Y: Yellow Note: Use a clear lens for pure white (PW) illumination.
	2. For square flush units	Polyarylate ø20 H4	HA9Z-L21*	
	3. For round extended units	Polyarylate ø20.2 H7.8	LBW9Z-L12*	
Buttons 	1. For round flush units	Polyacetal ø20 H3.2 (L5)	HA9Z-B11*	Specify the color code in place of * in the part no. B: Black, G: Green, R: Red, S: Blue W: White, Y: Yellow
	2. For square flush units	Polyacetal ø20 H3.9 (L5)	HA9Z-B21*	
	3. For round extended units	Polyacetal ø19.8 H7.3 (L9.1)	HA9Z-B12*	
Marking plate 	1. For round flush units	Acrylic ø17 t0.85 (L1.1)	HA9Z-P1*	Specify the color code in place of * in the part no. B: Black, W: White
	2. For square units	Acrylic □18.4 t0.85	HA9Z-P2*	
	3. For extended units	Acrylic ø15 t3.0	LBW9Z-P12W	
Anti-rotation Ring 	LBW series	Metal (Stainless steel) 25×8.2×24.8 t0.8	LBW9Z-LP6	
Locking ring 	All models	Polyamide ø17.9 H3.9	LB9Z-LN	

Dimensions for Accessories

All dimensions in mm.

For round units (LBW9Z-BS6*)

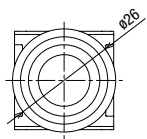

Mounting Hole Layout

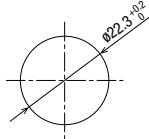

For round units (LBW9Z-BS6*)

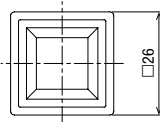

Mounting Hole Layout

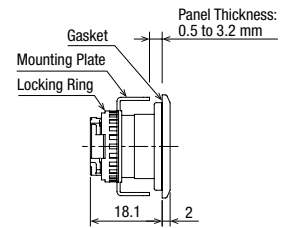
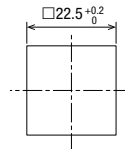

Terminal Cover

For SPDT/DPDT contacts (LB9Z-VL2)

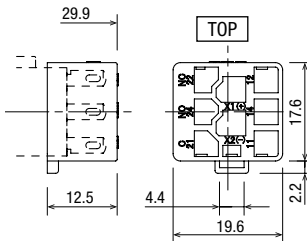

For 3PDT contacts (LB9Z-VL3)

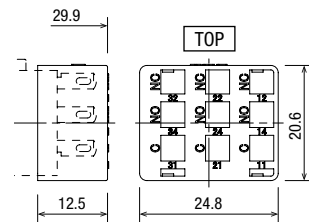

Key (Wave Key)

Reversible key

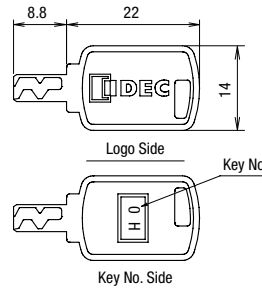

Non-reversible key

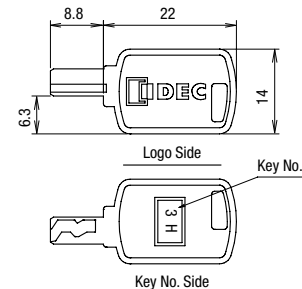

Maintenance Parts

Maintenance LED Unit

Package Quantity: 1

Shape	Rated Operating Voltage	Part No. (Ordering No.)	* Color Code
	5V DC	LB9Z-LED5*	A: Amber G: Green
	12V AC/DC	LB9Z-LED1*	PW: Pure White R: Red
	24V AC/DC	LB9Z-LED2*	S: Blue W: White

- Use a pure white (PW) LED unit for yellow (Y) illumination.

Transformer

Package Quantity: 1

Transformer	Primary Voltage	Secondary Voltage	Part No. (Ordering No.)	Applicable Load
	100/110V AC	100/110V AC ±10%	TWR512	LB9Z-LED2* (24V AC/DC LED unit)
	200/220V AC	200/220V AC ±10%	TWR522	
	400/440V AC	400/440V AC ±10%	TWR542	

- Terminal cover (TWR-VL3) is supplied as standard.
- Connect one LB9Z-LED2* to a transformer.

Specifications

Part No.	TWR5□2
Operating Voltage	100/110V AC, 200/220V AC, 400/440V AC (50/60Hz)
Current Draw	2.4VA
Rated Insulation Voltage	600V
Insulation Resistance	100 MΩ minimum (500V DC megger)
Operating Temperature	-30 to +60°C (no freezing)
Storage Temperature	-40 to +80°C (no freezing)
Operating Humidity	35 to 85% RH (no condensation)
Vibration Resistance	Damage Limits: 30 Hz, amplitude 1.5 mm Operating extremes: 5 to 55 Hz, amplitude 0.5 mm
Shock Resistance	Damage limits: 1,000 m/s ² Operating Extremes: 100 m/s ²
Dielectric Strength	2,500V AC, 1 minute
Terminal Screw	M3.5
Applicable Wire	2 mm ² maximum, 2 wires maximum
Weight (approx.)	87g

Dimensions

All dimensions in mm.

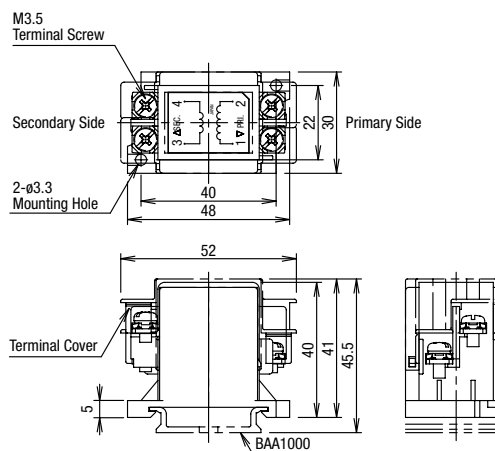

- Use end clip BC9Z-E/N35NPN10 when using 400/440V AC primary voltage transformers.

Precautions & Instructions  **Safety Precautions**

- Turn off the power to the LBW series control units before installation, removal, wiring, maintenance, and inspection. Failure to turn power off may cause electrical shocks or fire hazard.
- To avoid burning your hand, use the lamp holder tool when replacing the lamps.

- For wiring, use wires of a proper size to meet voltage and current requirements. Solder correctly according to the instructions in "Wiring" and "Notes on Terminal Cover." Improper soldering may cause overheating and create a fire hazard. Also, when using tab terminals, use receptacles of appropriate size.

Instructions

Wiring

1. Solder the terminals at 350°C within 3 seconds using a 60W soldering iron. Sn-Ag-Cu type is recommended. When soldering, do not touch the LB series with the soldering iron. Also ensure that no tensile force is applied to the terminals. Do not bend the terminal or apply excessive force to the terminal.
2. Use non-corrosive liquid flux.

Terminal Cover

Solder/tab terminal

Insert the terminal cover into the contact block with the TOP markings on the contact block and the terminal cover in the same direction.

Note: When wiring, insert the lead wires into the terminal cover holes before soldering. After wiring, terminal covers cannot be installed.

Standard Bezel



Flush Bezel



Operating Environment

- Do not use the LB series where corrosive gases exist or under an environment exceeding the operating temperature and humidity ranges. Otherwise, damage such as contact failure or change of the surface color may occur.
- Major parts of the switch are plastic. Scratches or damage may occur when scraped with a sharp object or if excessive load or shock is applied. Note that this may cause operation and appearance failure of the operator and bezel.
- Application of detergent, cutting oil, or special chemicals to the switch may result in operation and/or appearance failure such as a change in surface color.

Handling

Contacts (micro switch)

When using NC (normally closed) and NO (normally open) contacts of the same microswitch, avoid connections of different voltages, or connections of different types of power supplies. Failure to observe this instruction may cause a short-circuit.

Removing and Installing the Contact Block

3. Turn the locking lever on the contact block in the direction opposite to the arrow on the housing. Then the contact block can be removed.
4. Insert the contact block with the TOP markings on the contact block and the operator placed in the same direction. Then lock the units, turning the locking lever in the direction of the arrow.

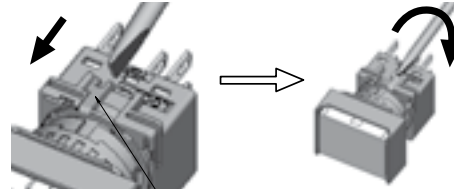

locking lever

Panel Mounting

Remove the contact block from the operator. Insert the operator into the panel cut-out from the front, then install the contact block to the operator.

Flush Bezel

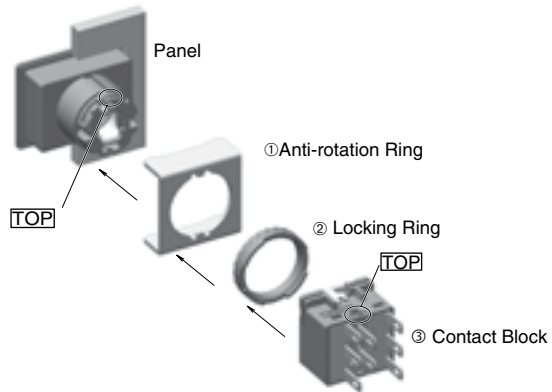

Notes on Mounting

Use the optional ring wrench (MT-001) to mount the operator onto the panel. Tightening torque should not exceed 0.7 N·m. Do not use pliers. Excessive tightening will damage the locking ring.

Mounts on the same panel as LB/LBW series

- Three illumination colors: Green (G), red (R), and white (W)

Specifications

Color Code	Red (R), White (W)	G (Green)
Rated Current (I)	7mA	2mA
Maximum Current (Ta: 25°C)	Reverse Voltage (V _R)	9V
	Operating Temperature (T _{opr})	-25 to +55°C (no freezing)
	Storage Temperature (T _{stg})	-30 to +80°C (no freezing)
Forward Voltage (V _f)	Standard value: 2V (I _f =7mA)	Standard value: 2.7V (I _f =2 mA)
Dielectric Voltage	Between live and dead parts: 500V AC, 1 minute	
Weight (approx.)	4.3g (UP8-89V1), 5.1g (UP8-89V2)	



UP Series

Mounting Hole Size	Shape	Degree of Protection (IEC 60529)	Matching LB/LBW Mounting Style	Part No.	Illumination Color Code
ø8 UP8	Shroud	IP40	Standard Bezel	UP8-89V1*	Specify the color code in place of * in the Part No. G: green R: red W: white
			Flush Bezel	UP8-89V2*	
ø9 UP9P	Shroud	IP65	Standard bezel Flush bezel	UP9P-99V1*	

- LED cannot be replaced.

Note: Connect an external current limiting resistor in series. Otherwise, the LED may be damaged.

Dimensions

All dimensions in mm.

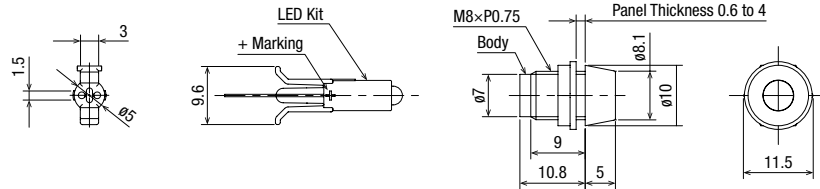

UP8-89V1

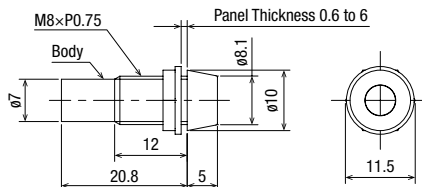

UP8-89V2

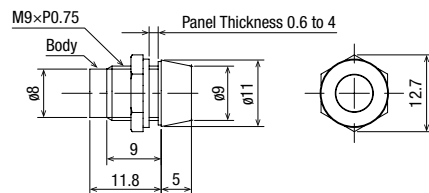

UP9P-99V1

[Assembly Drawing]

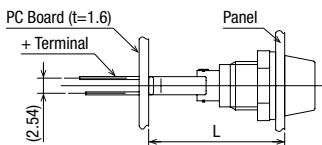

Dimensions (L)

Standard Bezel	22.5mm
Flush Bezel	29.9mm

PC Board Mounting Hole

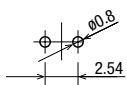

Panel Cut-out

UP8

UP9P

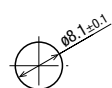

Internal Circuit

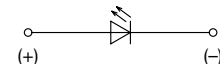

The longer pin is the positive terminal

! Safety Precautions

- Turn off power to the unit before installation, removal, wiring, maintenance, and inspection. Failure to turn off may cause electrical shocks or fire hazard.
- For wiring, use wires of a proper size to meet the voltage and current requirements.
- Improper soldering or failure to tighten the terminal screw may cause overheating and fire.

Single Board Mounting

UP series miniature pilot light single board mounting types can be mounted with LB/ LBW series on the same panel. Follow the instructions below on single board mounting.

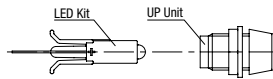

1. Mount the LED kit to the PC board.

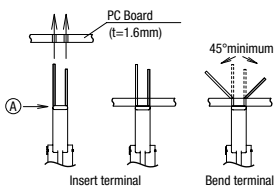

Temporary mounting

1. Note the polarity of the terminals and insert the terminals to the PC board.
2. Make sure that part A of the LED kit is pressed tightly to the PC board. Bend the terminals sideways as shown on the left.

2. Mount the operator and the UP series pilot lights on to the control panel.

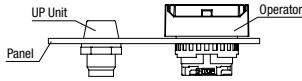

3. Mount the contact block to the operator of the miniature control unit and lock the unit by turning the locking lever.

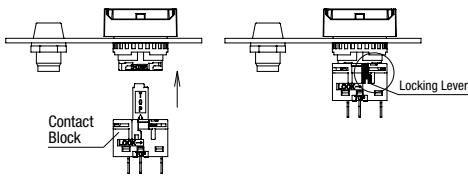

4. Install the PC board in 1. to the panel in 3.

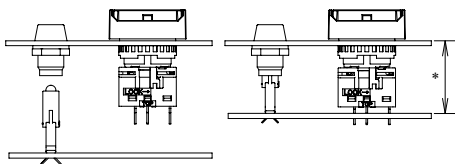

Note: Make sure that the LED kit is inserted into the UP series unit.

* When mounting LB/LBW and UP series on a single board, make sure that the distance between the front of the panel and the mounting side of the PC board (gasket distortion is taken into consideration) is as shown in the table below.

Part No.	Mountable Unit	Distance (*)
UP8-89V1*	Standard bezel	22.5mm
UP8-89V2*	Flush bezel	29.9mm
UP9P-99V1*	Standard bezel	22.5mm
	Flush bezel	29.9mm

5. Solder the terminals. Before soldering, make sure that each terminal of the contact block is securely inserted into the PC board holes.

Instructions

Polarity

Pay attention to the polarity of the power supply as UP series units do not contain a diode for protection against reverse polarity. The long terminal is positive and the short terminal is negative.

Current Limiting Resistor

When using a UP series unit without a built-in current limiting resistor, connect an external current limiting resistor. Calculate the resistance using the following formula.

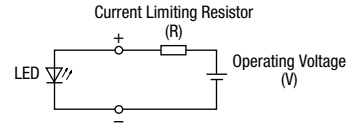

$$\text{Resistance } (\Omega) = \frac{\text{Operating Voltage (V)} - \text{Forward Voltage (Vf)}}{\text{Rated Current (I)}}$$

- * Rated Current (I) = R (red), W (white) : 0.007A
G (green) : 0.002A
- Forward Voltage (Vf) = R (red), W (white) : 2V
G (green) : 2.7V

Note: Use a resistor of higher resistance than the calculated value (Ω)

$$\text{Rated Wattage of Resistor (W)} = \text{Rated Current (I)} \times \text{Operating Voltage (V)} \times 2 \text{ to } 3$$

* 2 to 3 is a safety factor

<Current Limiting Resistor Reference Value>

Operating Voltage	Color	
	Red (R), White (W)	Green (G)
5V DC	430Ω (1/4W)	1200Ω (1/4W)
6V DC	560Ω (1/4W)	1600Ω (1/4W)
12V DC	1500Ω (1/4W)	4700Ω (1/4W)
24V DC	3000Ω (1/2W)	11000Ω (1/4W)

Wiring

Solder the terminal at 350°C within 3 seconds using a 60W soldering iron. SnAgCu type lead-free solder is recommended.

When soldering, do not touch the pilot light housing with the terminal. Do not bend the terminal or apply excessive force to the terminal.

Notes on Panel Mounting

Tightening torque should not exceed 0.49 N·m. Do not use pliers. Do not tighten with excessive force, otherwise the locking ring will be damaged.

PC Board and Circuit Design

Use glass epoxy copper clad laminate, double-sided through-hole PC boards with a thickness of 1.6 mm.

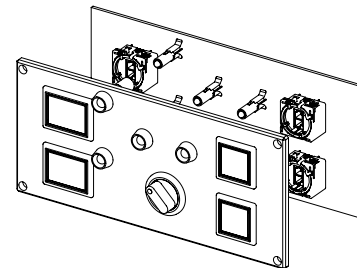

Example of single board mounting

22mm XW E-Stops

Key features:

- The depth behind the panel can be as little as 46.4 mm for 1 to 4 contacts (with terminal cover) for illuminated and non-illuminated units.
- IDEC's original "Safe break action" ensures that the NC contacts open when the contact block is detached from the operator.
- 1 to 4NC main contacts and 1 or 2NO monitor contacts
- Push-to-lock, Pull or Turn-to-reset operator
- Models with mechanical indicator on the operator body show the normal/latched status (green: normal).
- Safety lock mechanism (IEC60947-5-5, 6.2)
- Degree of protection IP65 (IEC60529)
- Fingersafe (IP20) terminals
- Three button sizes: ø38, ø40 and ø60 mm
- Push-ON illumination type available (40mm mushroom head)
- Direct opening action mechanism (IEC60947-5-5, 5.2, IEC60947-5-1, Annex K)
- RoHS compliant (EU directive 2002/95/EC).
- UL c-UL listed. EN compliant
- UL NISD category emergency stop device (File# E305148)



UL File #E68961



CCC No. 2005010305150897







Specifications



Applicable Standards	IEC60947-5-5, EN60947-5-5, JIS C8201-5-1, UL508, UL991, NFPA79, CSA C22.2 No. 14, GB14048.5
Operating Temperature	Non-illuminated: -25 to +60°C (no freezing), Illuminated: -25 to +55°C (no freezing)
Operating Humidity	45 to 85% RH (no condensation)
Storage Temperature	-45 to +80°C
Operating Force	Push-to-lock: 32N Pull-to-reset: 21N Turn-to-reset: 0.27N·m
Minimum Force Required for Direct Opening Action	80N
Min Operator Stroke Required for Direct Opening Action	4mm
Maximum Operator Stroke	4.5mm
Contact Resistance	50mΩ maximum (initial value)
Contact Material	Gold plated silver
Insulation Resistance	100MΩ minimum (500V DC megger)
Impulse Withstand Voltage	2.5kV
Pollution Degree	3
Operation Frequency	900 operations/hour
Shock Resistance	Operating extremes: 150m/s ² (15G), Damage limits: 1000m/s ² (100G)
Vibration Resistance	Operating extremes: 10 to 500Hz, amplitude 0.35mm acceleration 50m/s ² Damage limits: 10 to 500Hz, amplitude 0.35mm acceleration 50m/s ²
Mechanical Life	250,000 operations minimum
Electrical Life	100,000 operations minimum, (250,000 operations minimum @ 24V AC/DC, 100mA)
Degree of Protection	Operator: IP65 (IEC60529) Terminal: IP20 (when XW9Z-VL2MF is installed)
Terminal Style	M3.0 screw terminal
Recommended Tightening Torque for Locking Ring	2.0N·m
Wire Size	16 AWG max
Weight	ø40mm: 72g ø60mm: 81g

Part Numbers

Standard Button Without Mechanical Indicator

Style	Operator Type	Monitor Contact	Main Contact	Part Number
 Non-Illuminated 40mm Mushroom		1NO	1NC	XW1E-BV411M-R
		-	2NC	XW1E-BV402M-R
		2NO	2NC	XW1E-BV422M-R
		1NO	3NC	XW1E-BV413M-R
		-	4NC	XW1E-BV404M-R
		1NO	1NC	XW1E-BV511M-R
 60mm Mushroom		-	2NC	XW1E-BV502M-R
		2NO	2NC	XW1E-BV522M-R
		1NO	3NC	XW1E-BV513M-R
		-	4NC	XW1E-BV504M-R
		1NO	1NC	XW1E-LV411Q4M-R
		-	2NC	XW1E-LV402Q4M-R
 Illuminated ¹ 40mm Mushroom with built-in 24V AC/DC LED		2NO	2NC	XW1E-LV422Q4M-R
		1NO	3NC	XW1E-LV413Q4M-R
		-	4NC	XW1E-LV404Q4M-R
		1NO	1NC	XW1E-LV411Q4M-R
		-	2NC	XW1E-LV402Q4M-R
		1NO	3NC	XW1E-LV413Q4M-R
 40mm Mushroom Push-ON LED ²		1NO	2NC	XW1E-TV412Q4M-R
		1NO	3NC	XW1E-LV413Q4M-R

Smooth Button With Mechanical Indicator

Style	Operator Type	Monitor Contact	Main Contact	Part Number		
 Non-Illuminated 38mm Mushroom		-	1NC	XW1E-BV4TG01MR		
		-	2NC	XW1E-BV4TG02MR		
		-	3NC	XW1E-BV4TG03MR		
		-	4NC	XW1E-BV4TG04MR		
		1NO	1NC	XW1E-BV4TG11MR		
		1NO	2NC	XW1E-BV4TG12MR		
		1NO	3NC	XW1E-BV4TG13MR		
		2NO	4NC	XW1E-BV4TG22MR		
		 Illuminated 38mm Mushroom with built-in 24V AC/DC LED ¹		-	1NC	XW1E-LV4TG01Q4MR
				-	2NC	XW1E-LV4TG02Q4MR
-	3NC			XW1E-LV4TG03Q4MR		
-	4NC			XW1E-LV4TG04Q4MR		
1NO	1NC			XW1E-LV4TG11Q4MR		
1NO	2NC			XW1E-LV4TG12Q4MR		
1NO	3NC			XW1E-LV4TG13Q4MR		
2NO	2NC			XW1E-LV4TG22Q4MR		

- 1. The light is independent of the position of the switch, except for push-on LED type.
- 2. The light only operates when the switch is pressed as it is internally wired.

- Note: Pushlock pull/turn reset switches are locked when pressed, and reset when pulled or turned clockwise.
- 1. LED lamp is not removable.

XW Series EMO Switches

Style	NC Main Contact	NO Monitor Contact	Part Number
 40mm Mushroom	1NC	-	XW1E-BV401M-RH-EMO
	2NC	-	XW1E-BV402M-RH-EMO
	3NC	-	XW1E-BV403M-RH-EMO
	4NC	-	XW1E-BV404M-RH-EMO
	1NC	1NO	XW1E-BV411M-RH-EMO
	2NC	1NO	XW1E-BV412M-RH-EMO
	3NC	1NO	XW1E-BV413M-RH-EMO
	2NC	2NO	XW1E-BV422M-RH-EMO

FB Enclosures with XW E-Stops

 40mm Push-lock Turn/Pull Reset Non-Illuminated	2NC	-	FB1W-XW1E-BV402MR
	1NC	1NO	FB1W-XW1E-BV411MR
	2NC	2NO	FB1W-XW1E-BV422MR
	3NC	1NO	FB1W-XW1E-BV413MR
	4NC	-	FB1W-XW1E-BV404MR
 40mm Push-lock Turn/Pull Reset Illuminated*	2NC	-	FB1W-XW1E-LV402MR
	1NC	1NO	FB1W-XW1E-LV411MR
	2NC	2NO	FB1W-XW1E-LV422MR
	3NC	1NO	FB1W-XW1E-LV413MR
 60mm Push-lock Turn/Pull Reset Non-Illuminated	4NC	-	FB1W-XW1E-BV504MR
	2NC	-	FB1W-XW1E-BV502MR
	1NC	1NO	FB1W-XW1E-BV511MR
	2NC	2NO	FB1W-XW1E-BV522MR
	3NC	1NO	FB1W-XW1E-BV513MR
	4NC	-	FB1W-XW1E-BV504MR



For added safety, Switch Guards and Nameplates can be used with E-Stop Enclosures

*LED illumination voltage: 24V AC/DC

Contact Ratings

Rated Insulation Voltage (Ui)		250V				
Rated Current (Ith)		5A				
Rated Operating Voltage (Ue)		30V	125V	250V		
Rated Operating Current	Main Contacts (NC)	AC 50/60Hz	Resistive Load (AC-12)	–	5A	3A
			Inductive Load (AC-15)	–	3A	1.5A
	DC	Resistive Load (DC-12)	2A	0.4A	0.2A	
		Inductive Load (DC-13)	1A	0.22A	0.1A	
Rated Operating Current	Monitor Contacts (NO)	AC 50/60Hz	Resistive Load (AC-12)	–	1.2A	0.6A
			Inductive Load (AC-14)	–	0.6A	0.3A
	DC	Resistive Load (DC-12)	2A	0.4A	0.2A	
		Inductive Load (DC-13)	1A	0.22A	0.1A	



Minimum applicable load: 5V AC/DC, 1mA (reference value).
The rated operating currents are measured at resistive/inductive load types specified in IEC 60947-5-1.

Mounting Hole Layout

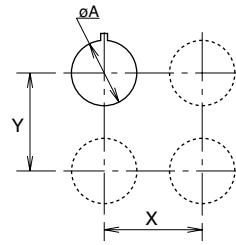

Measurements

Size	øA	X & Y
40mm	22.3 ^{+0.4}	70mm min

Panel Cutout

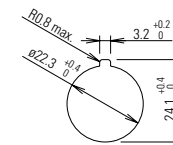

Illuminated Unit LED Ratings

Operating Voltage	Current
24V AC/DC ±10%	15mA

Depth Behind the Panel

Depth (mm)	Description
46.4	with indicator, 1 - 4 contacts, both illuminated and non-illuminated
48.7	w/o indicator, 1 - 4 contacts, both illuminated and non-illuminated

Part Number Key

XW1E - L V 4 TG 11 Q4MR

Illumination	Indicator	Contact Configuration	Color
B: Non-Illuminated L: Illuminated LED T: Illuminated Push-ON LED	TG: w/green mechanical indicator blank: w/o indicator	11: 1NO - 1NC 02: 2NC 13: 1NO - 3NC 04: 4NC 22: 2NO-2NC 12: 1NO-2NC (Push-ON LED only) 01: 1NC (EMO switch only) 03: 3NC (EMO switch only)	R: red with indicator -R: red w/o indicator -RH-EMO: red w/o indicator with EMO engraving
Mushroom Size		Voltage Code	
4: ø40mm 5: ø60mm (non-illuminated only)		Blank: Non-illuminated Q4: Illuminated 24V AC/DC	

Terminal Arrangements (Bottom View)

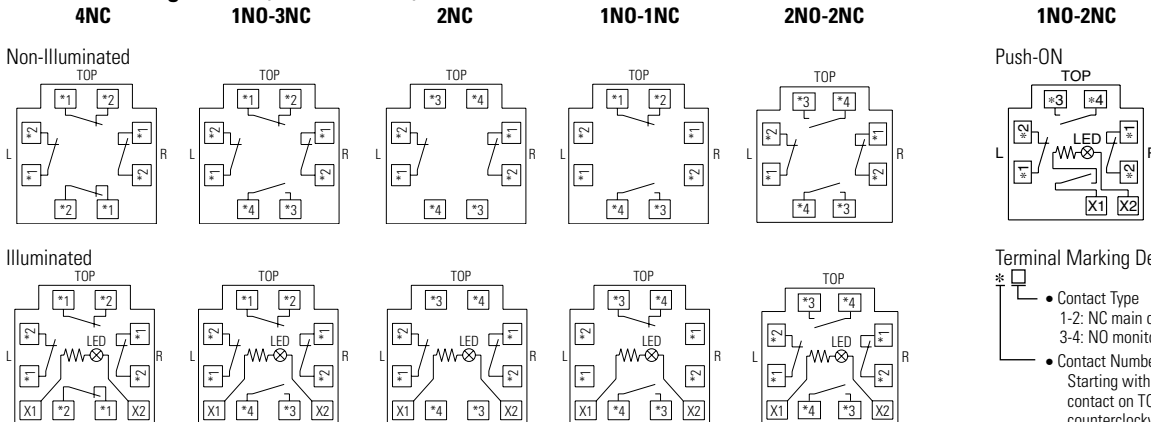

Terminal Marking Description

- Contact Type
1-2: NC main contact
3-4: NO monitor contact
- Contact Number (1-4)
Starting with the contact on TOP in a counterclockwise direction.
Note:
1: contact on the TOP
2: contact on the Left
3: contact on the Bottom
4: contact on the Right

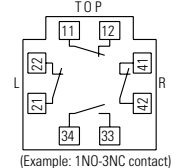

Dimensions (mm)

XW Standard Button Non-Illuminated Without Indicator (with terminal cover)

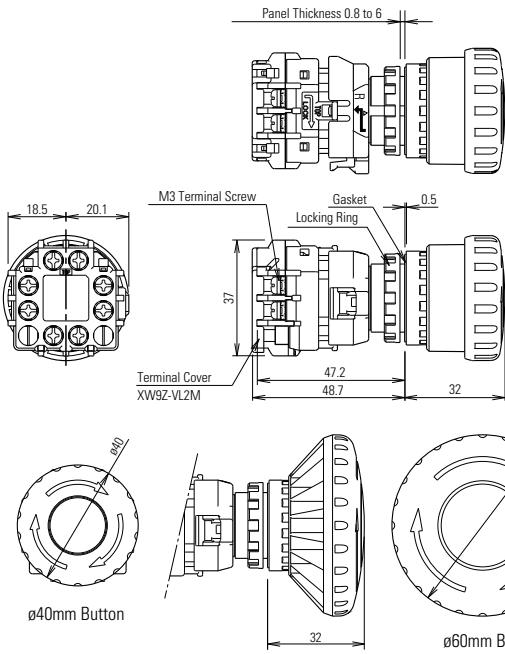

XW Standard Button LED Illuminated/ Push-ON Without Indicator (with terminal cover)

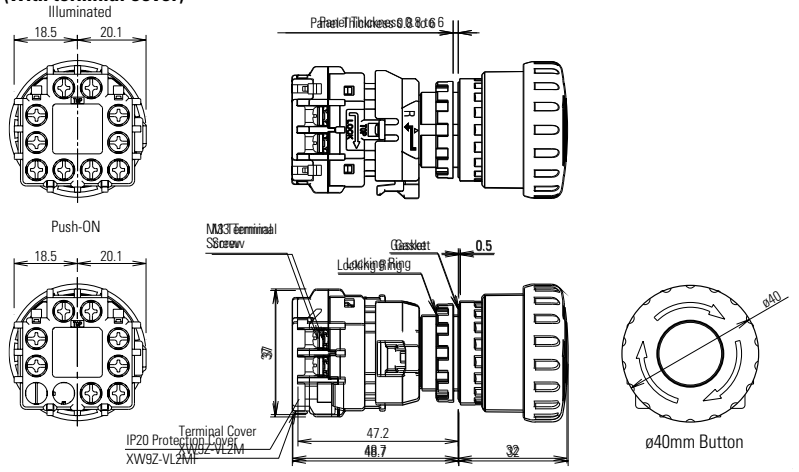

XW Smooth Button Non-Illuminated With Indicator (with terminal cover)

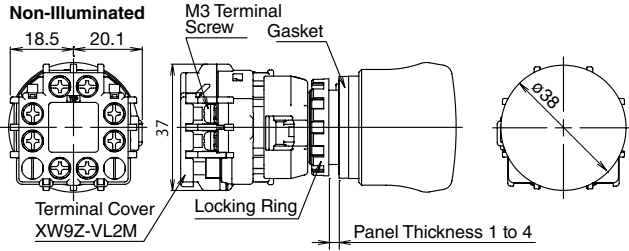

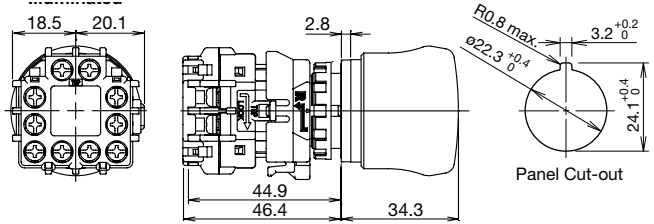

XW Smooth Button LED Illuminated/ Push-ON With Indicator (with terminal cover)

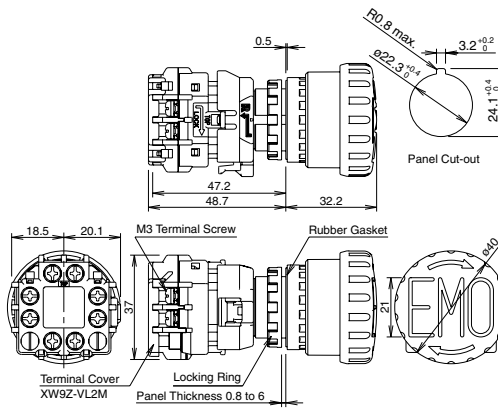
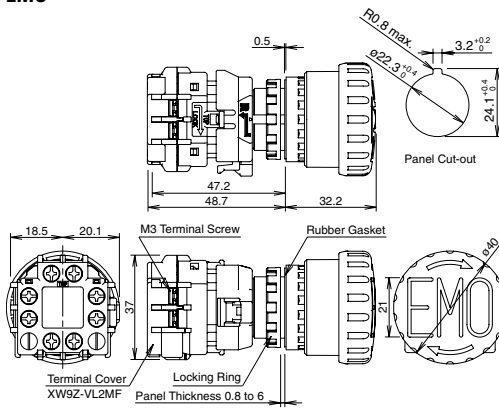

EMO



Accessories: Terminal Covers





Appearance	Description	Part Numbers
	Terminal Cover for contact block	XW9Z-VL2M
	IP20 Fingersafe Cover	XW9Z-VL2MF

Accessories: Nameplates

Appearance	Legend	Part Number	Inner Ø	Outer Ø
	(blank)	HWAV-0	22mm	60mm
	"Emergency Stop"	HWAV-27	22mm	60mm
	(blank)	HWAV5-0	22mm	80mm
	"Emergency Stop"	HWAV5-27	22mm	80mm

 Use 60mm nameplates for 38mm and 40mm mushroom buttons and 80mm nameplates for 60mm mushroom buttons.

Accessories: Shrouds

Appearance	Part Numbers	E-Stop Types	Applicable Standards
	HW9Z-KG1	38mm, 40mm Mushroom Head	SEMI S2-0703, 12.5.1 Compliant
	HW9Z-KG2	38mm, 40mm, and 60mm Mushroom Head	SEMI S2-0703, 12.5.1 & SEMATECH Compliant
	HW9Z-KG3	38mm, 40mm Mushroom Head	SEMI S2 Compliant (Approved by TUV)
	HW9Z-KG4	38mm, 40mm Mushroom Head	SEMI S2 Compliant (Approved by TUV) & SEMATECH

Operating Instructions

Removing the Contact Block

First unlock the operator button. Grab the bayonet ring ① and pull back the bayonet ring until the latch pin clicks ②, then turn the contact block counterclockwise and pull out ③.

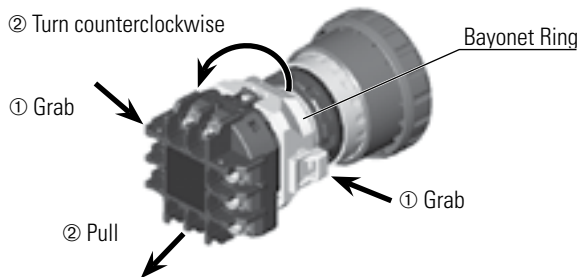

Notes for removing the contact block

1. When the contact block is removed, the monitor contact (NO contact) is closed.
2. While removing the contact block, do not exert excessive force, otherwise the switch may be damaged.
3. An LED lamp is built into the contact block for illuminated pushbuttons. When removing the contact block, pull the contact block straight to prevent damage to the LED lamp. If excessive force is exerted, the LED lamp may be damaged and fail to light.

Panel Mounting

Remove the locking ring from the operator and check that the rubber gasket is in place. Insert the operator from panel front into the panel hole. Face the side without thread on the operator with TOP marking upward, and tighten the locking ring using ring wrench HW9Z-T1 to a torque of 2.0 N·m maximum.

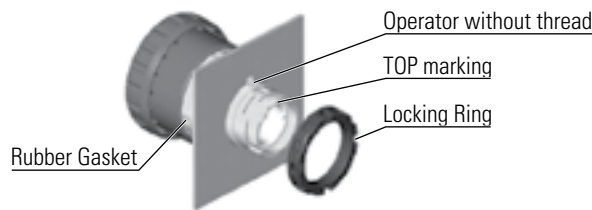

Notes for Panel Mounting

To prevent the XW emergency stop switch from rotating when resetting from the latched position, use of an anti-rotation ring (HW9Z-RL) or a nameplate is recommended.

Installing the Contact Block

First unlock the operator button. Align the small ▲ marking on the edge of the operator with the small ▼ marking on the yellow bayonet ring. Hold the contact block, not the bayonet ring. Press the contact block onto the operator and turn the contact block clockwise until the bayonet ring clicks.

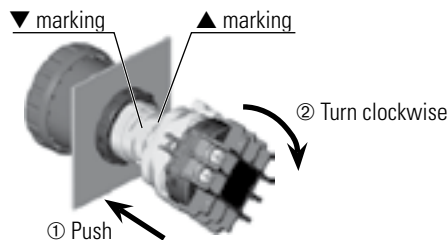

Notes for installing the contact block

Make sure that the bayonet ring is in the locked position. Check that the two projections on the bayonet ring are securely in place.

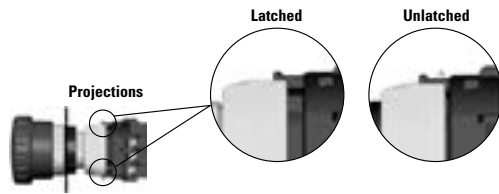

Wiring

The applicable wire size is 16 AWG maximum.

Screw Terminal

1. Wire thickness: AWG18 to 16
2. Tighten the M3 terminal screw to a tightening torque of 0.6 to 1.0 N·m.

Installing and Removing Terminal Covers

XW9Z-VL2M

To install the terminal cover, align the TOP marking on the terminal cover with the TOP marking on the contact block. Place the two projections on the bottom side of the contact block into the slots in the terminal cover. Press the terminal cover toward the contact block.

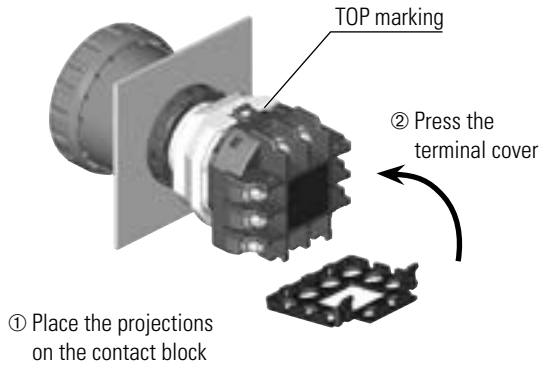

To remove the terminal cover, pull out the two latches on the top side of the terminal cover. Do not exert excessive force to the latches, otherwise the latches may break.

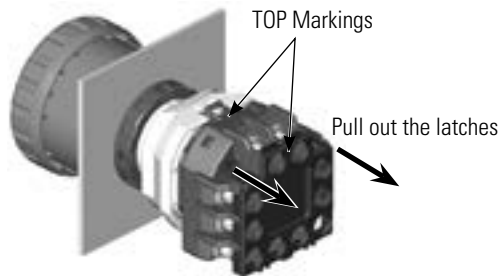

IP20 Protection Terminal Cover XW9Z-VL2MF

To install the IP20 protection cover, align the TOP marking on the cover with the TOP marking on the contact block, and press the cover toward the contact block.

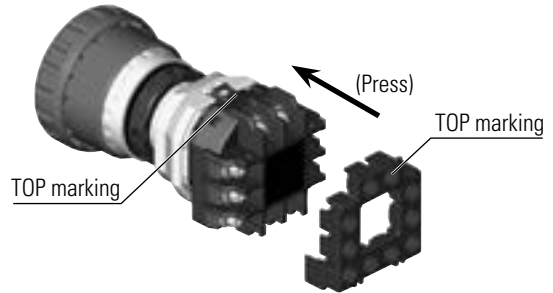

1. Once installed, the XW9Z-VL2MF cannot be removed.
2. The XW9Z-VL2MF cannot be installed after wiring.
3. With the XW9Z-VL2MF installed, crimping terminals cannot be used.
4. Make sure that the XW9Z-VL2MF is securely installed. IP20 protection cannot be achieved when installed loosely, and electric shocks may occur.

Contact Bounce

When the button is reset by pulling or turning, the NC main contacts will bounce. When pressing the button, the NO monitor contacts will bounce.

When designing a control circuit, take the contact bounce time into consideration (reference value: 20 ms).

LED Illuminated Switches

LED lamp is built into the contact block and cannot be replaced.

Installing the Anti-rotation Ring HW9Z-RL

Align the side without thread on the operator with TOP marking, the small marking on the anti-rotation ring, and the recess on the mounting panel.

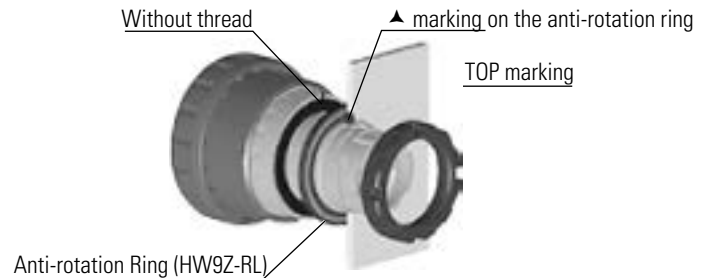

AP22M Series



Key Features

- Viewable in direct sunlight.
- Visible from all directions.
- The use of an ultra-bright LED that is not susceptible to external scattered light ensures high visibility and provides for more accurate recognition.
- Integrated terminal cover is IP20 protected (finger protection), preventing electrical shocks.
- UL and c-UL listed, EN standard compliant.
- Colored and clear lenses are offered. Clear lens (except for PW) provides for higher contrast.
- UL Type 4X





Part Numbers

Pilot Lights

Appearance	Lens	Rated Voltage	Part Number	Lamp Color
	Color	12V DC 24V AC/DC 120V AC	AP22M-2Q②①	R G Y A S PW
	Clear		AP22M-2Q②C①	R G Y A S

1. In place of ① insert LED color. Red (R), Green (G), Yellow (Y), Amber (A), Blue (S), and White (PW).
2. Clear lenses are standard (except for white). White (PW) only available as colored lens.
3. In place of ② insert voltage code. For 12V DC use (3), for 24V AC/DC use (4), for 120V AC use (H).
4. LED cannot be removed or replaced.

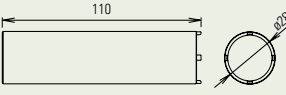
Accessories

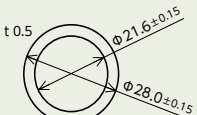
Appearance	Material	Part Number	Notes
	Metal (brass)	MW9Z-T1	Used for mounting unit into a panel. 
	Resin	YW9Z-PL12①	Dimension: ø29.8 H14.5 In place of ① insert color: R (Red), G (Green), Y (Yellow), A (Amber), S (Blue), C (Clear*)
	Nitrile rubber	HW9Z-WM	

1. Nameplates: HWAM, HWAS-0, and CWAM. Go to www.IDEC.com and review HW Series and CW Series catalogs for detailed information.
2. *Use a clear lens (C) for a PW (White) lamp.

Specifications

Environment	Operating Temperature: -25 to +55°C (no freezing) Storage Temperature: -45 to +80°C (no freezing) Operating Humidity: 45-85%RH (no condensation)	
Insulation Resistance	100MΩ (DC500V megger)	
Over Voltage Category	II (IEC60664-1)	
Impulse Dielectric Strength	2.5kV (IEC60664-1, IEC60947-5-1)	
Degree of pollution	3 (IEC60947-5-1)	
Dielectric Strength	between terminals of different poles: 2,000V AC, 1 min between live and non-live parts: 2,000V AC, 1 min	
Vibration Resistance	Operation limit	5-55Hz half amp: 0.5mm
	Damage limit	30Hz half amp: 1.5mm
Shock Resistance	Operation limit	100m/s ² (10G)
	Damage limit	1000m/s ² (100G)
Degree of Protection	Panel front: IP66 (IEC 60529), UL Type 4X Terminals: IP20	
Terminal Size	M3.5 screw	
Tightening torque for terminal screw	1.0N•m	
Tighten'g torque for Locking Ring	2.0N•m	
Wire Size	AWG16 ~ AWG14, 2 wires max.	
Weight (approx.)	18g	

Lamp Ratings

Rated Voltage	12V DC, 24V AC/DC, 120V AC
Voltage Range	12V DC ±5%, 24V AC/DC ±10%, 120V AC ±10%
LED Illumination Color	Red (R), Green (G), Yellow (Y), Amber (A), Blue (S), and White (PW)
Rated Current	12V DC: R, A, Y - 21mA; G, S, PW - 22mA 24V AC/DC, 120V AC: 24mA (all colors)
LED Life (Ref.)	Approx. 30,000 Hrs. at rated DC voltage at 25°C in specified environmental conditions (The brightness reduces to 50% of initial value.)

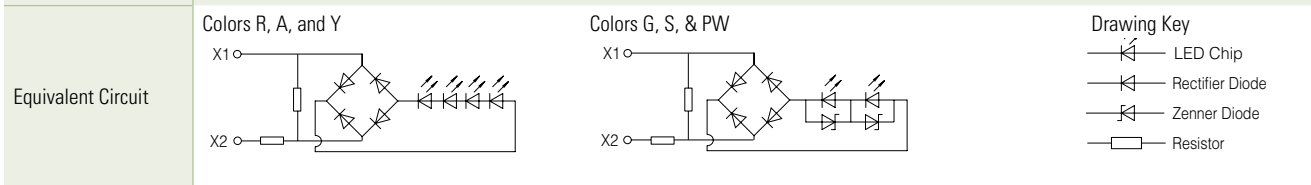

Dimensions (mm)

Panel cut-out (mm)

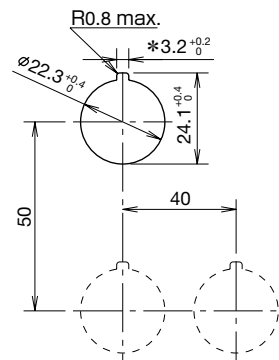
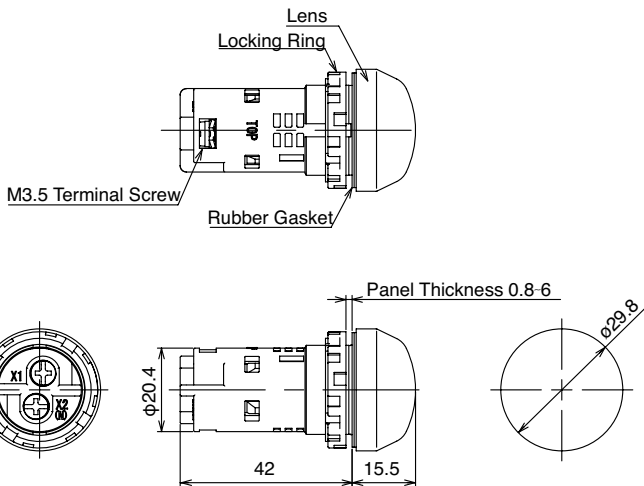

A 3.2mm^{+0.2}/₀ opening (notch) is used to stop rotation.
(Not necessary if a nameplate is not used.)

Safety Instructions

Turn off the power before installation, removal, wiring, maintenance and inspection. Failure to turn off power may cause electrical shocks or fire hazard.

When wiring, use proper size (AWG16 - AWG14) wires to meet voltage and current requirements. Tighten the terminal screws to a recommended tightening torque (1.0N•m). Operating with loose terminal screws may cause overheating and fire.

Installation Instructions

Panel Mounting

Remove the locking ring and check if the rubber gasket is properly aligned. Then insert the AP22M unit, aligning the "TOP" marking with the recess into the panel cut-out, and tighten the locking ring.

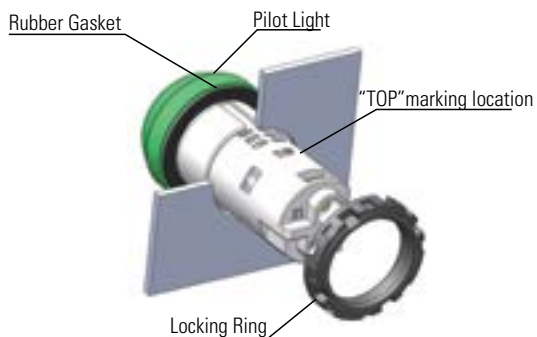

When installing the pilot light into a panel cut-out, use locking ring wrench (part number MW9Z-T1) to tighten the locking ring to a recommended torque of 2.0N•m. Do not use pliers and do not tighten excessively, otherwise the unit may become damaged.

Mounting Notes

Applicable Wires

The applicable wire sizes are from AWG14 to AWG16 with 2 wires max. A ring-tongue crimp style terminal cannot be used.

Applicable Terminal

Fork Crimp Terminal

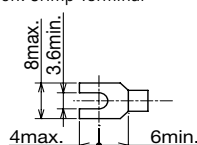

Bar Type Crimp Terminal

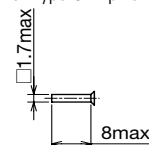

Single Wire

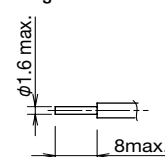

Noise

External noise may cause LED chips to deteriorate, leading to a reduction in brightness, a change in color, or malfunction. We recommend the following solution if this problem exists. However, please note that this solution will vary depending on the operating environment and the application.

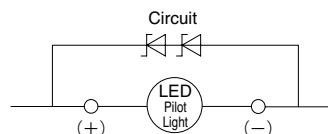

Zener Diode Reference Value
Zener Voltage: 15V (1W)



Great Visibility - even from inside a train (automatic safety fence on a train station platform)



Compact Size - Perfect for mounting on small or narrow surfaces.

ø22 Flush Mount CW Switches & Pilot Devices

Flush bezel projects only 2.5mm from front of panel and as little as 39.9mm behind the panel!

Key features:

- ø22.3mm mounting hole compliant with IEC 60947-5-1
- 3.5-mm operator travel for pushbuttons ensures comfortable and reliable operation
- Up to 6 contacts per switch are possible with use of dual contact blocks
- Black and metallic bezels available
- Illuminated pushbuttons, pushbuttons, pilot lights, selector switches and key selector switches are available
- Direct opening NC contact
- Seven different keys can be chosen for key selector switches
- 10A contact rating; up to three contact blocks for non-illuminated and two contact blocks for illuminated models can be connected
- Contact blocks can be removed by locking lever
- IP20 finger-safe screw terminals
- UL Type 4X rating



Applicable Standards	Mark	File No. or Organization
UL508 CSA C22.2 No.14		UL/c-UL File No. E68961
EN60947-5-1		TÜV SÜD
		EC Low Voltage Directive

Specifications

Operating Temperature	Non-illuminated: -25 to +60°C (no freezing) LED illuminated: -25 to +55°C (no freezing)
Operating Humidity	45 to 85% RH (no condensation)
Storage Temperature	-40 to +80°C
Contact Resistance	50 mΩ maximum (initial value)
Insulation Resistance	100 MΩ minimum (500V DC megger)
Overvoltage Category	II (IEC 60664-1)
Impulse Withstand Voltage	2.5 kV (IEC60664-1/60947-5-1)
Pollution Degree	3 (IEC60947-5-1)
Vibration Resistance	Operating extremes: 5 to 55Hz, amplitude 0.5mm
Shock Resistance	Operating extremes: 100m/s ² Damage limits: 1000m/s ²
Mechanical Life (minimum operations)	Pushbutton, illuminated pushbutton: 2,000,000 Selector switch: 250,000 Key selector switch: 250,000
Electrical Life (minimum operations)	50,000 (see Contact Ratings) 100,000 (see Contact Ratings) (switching frequency 1800 operations/h)
Degree of Protection (IEC60529)	Panel front: IP65 Terminals: IP20 Type 4X
Short-circuit Protection	250V/10A fuse, (Type aM IEC60269-1, IEC602069-2)
Electrical Shock Protection	Class II (IEC61140)
Terminal Style	Screw terminal (M3.5 slotted Phillips screw)
Bezel Material	Polyamide
Applicable Wire Size	Up to 2 wires of 2mm ² (solid wire ø1.6) maximum (AWG14 to 16) (Ring terminal cannot be used)
Recommended Tightening Torque	Terminal: 1.0 to 1.3N·m Locking ring: 1.2N·m

Contact Ratings

Rated Insulation Voltage (Ui)		300V				
Rated Thermal Current (Ith)		10A				
Rated Operating Voltage (Ue)		24V	120V	240V		
Rated Operating Current (Ie)	Electrical Life 50,000 operations	AC 50/60Hz	Resistive Load (AC-12)	10A	10A	6A
			Inductive Load (AC-15)	10A	6A	3A
		DC	Resistive Load (DC-12)	8A	2.2A	1.1A
		Inductive Load (DC-13)	4A	1.1A	0.55A	
	Electrical Life 100,000 operations	AC 50/60Hz	Resistive Load (AC-12)	5A	5A	3A
			Inductive Load (AC-15)	5A	3A	1.5A
DC		Resistive Load (DC-12)	4A	1.1A	0.55A	
	Inductive Load (DC-13)	2A	0.55A	0.27A		
Contact Material				Silver		



1. Minimum applicable load (reference value): 3V AC/DC, 5mA (Applicable range is subject to the operating conditions and load.)
2. The operational current represents the classification by making and breaking currents (IEC 60947-5-1).
3. UL, c-UL rating: A300

Direct Opening of Key Selector Switch

	2-position (3NC)	3-position (2NC)
Operator Angle for Direct Opening Action	90°	45°
Minimum Operator Torque for Direct Opening Action	0.2N·m	0.3N·m
Maximum Operator Angle	90°	45°

Weights

Illuminated Pushbutton	46g (CW1L-M1E02QH, 2 contacts) 62g (CW1L-M1E22QH, 4 contacts)
Pushbutton	45g (CW1B-M1E03, 3 contacts) 52g (CW1B-M1E22, 4 contacts)
Pilot Light	27g (CW1P-1EQH)
Selector Switch	48g (CW1S-2E03, 3 contacts) 55g (CW1S-2E22, 4 contacts)
Key Selector Switch	61g (CW1K-2AE03, 3 contacts) 68g (CW1K-2AE22, 4 contacts)

LED Module

Rated Insulation Voltage (Ui)	250V				
Rated Operating Voltage (Ue)	6V AC/DC	12V AC/DC	24V AC/DC	100/120V AC	230/240V AC
Operating Voltage Range	6V AC/DC±10%	12V AC/DC±10%	24V AC/DC±10%	100/120V AC±10%	230/240V AC±10%
Illumination Color Code ②	A (amber), G (green), PW (white), R (red), S (blue)				
LED Module Part Number	CW-EAQ2②	CW-EAQ3②	CW-EAQ4②	CW-EAQH②	CW-EAQM4②
Current Draw	15mA	15mA	16.5mA	18mA	18mA
Life (reference value)	Approx. 30,000 hours				
Internal Circuit					

- Specify an illumination color code in place of ② in the part number.
- Use the white (PW) LED module for yellow illumination.

Contact Blocks

Contact Block	Single Contact Block		Double Contact Block		
Contact	1NO	1NC	2NO	2NC	1NO-1NC
Part No.	YW-E10R	YW-E01	YW-EW2R0	YW-EW02	YW-EW1R1
Shape					
Housing Color	Blue/Black	Reddish Purple	Blue/Black	Reddish Purple	Reddish Purple/Blue
Push Rod Color	Black	Red	Black	Red	Gray
Terminal No.	3-4	1-2	1st tier: 13-14 2nd tier: 23-24	1st tier: 11-12 2nd tier: 21-22	1st tier: (NO) 13-14 2nd tier: (NC) 21-22
Weight (approx.)	11g		19g		

Degree of Protection

Rating	IP65	IP66	IP67	UL Type 4X
Illuminated Pushbutton	Yes	Yes *	Yes *	Yes *
Pilot Light	Yes	Yes	No	Yes
Pushbutton	Yes	Yes *	Yes *	Yes *
Selector Switch	Yes	Yes	Yes	Yes
Key Selector Switch	Yes	Yes	No	Yes

*When used with rubber boot (CW9Z-D11, -D12)

Mounting Hole Layout

IEC 60947-5-1 compliant

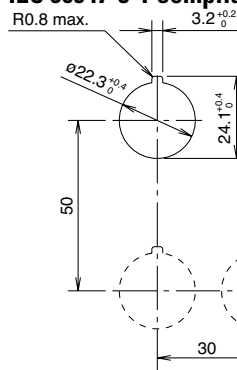

Note: Determine mounting centers to ensure proper spacing.

Illuminated Pushbuttons (Assembled)

Style	Operating Voltage	Contact Configuration	Black Bezel	Metallic Bezel	Illumination Color Code ②
Round Flush CW□L-□1	6V AC/DC	1NO 1NC 1NO-1NC 2NO 2NC 2NO-2NC	CW1L-③1E10Q2② CW1L-③1E01Q2② CW1L-③1E11Q2② CW1L-③1E20Q2② CW1L-③1E02Q2② CW1L-③1E22Q2②	CW4L-③1E10Q2② CW4L-③1E01Q2② CW4L-③1E11Q2② CW4L-③1E20Q2② CW4L-③1E02Q3② CW4L-③1E22Q2②	A: amber G: green PW: white R: red S: blue Y: yellow
	12V AC/DC	1NO 1NC 1NO-1NC 2NO 2NC 2NO-2NC	CW1L-③1E10Q3② CW1L-③1E01Q3② CW1L-③1E11Q3② CW1L-③1E20Q3② CW1L-③1E02Q3② CW1L-③1E22Q3②	CW4L-③1E10Q3② CW4L-③1E01Q3② CW4L-③1E11Q3② CW4L-③1E20Q3② CW4L-③1E02Q3② CW4L-③1E22Q3②	
(black bezel)	24V AC/DC	1NO 1NC 1NO-1NC 2NO 2NC 2NO-2NC	CW1L-③1E10Q4② CW1L-③1E01Q4② CW1L-③1E11Q4② CW1L-③1E20Q4② CW1L-③1E02Q4② CW1L-③1E22Q4②	CW4L-③1E10Q4② CW4L-③1E01Q4② CW4L-③1E11Q4② CW4L-③1E20Q4② CW4L-③1E02Q4② CW4L-③1E22Q4②	
	100/120V AC	1NO 1NC 1NO-1NC 2NO 2NC 2NO-2NC	CW1L-③1E10QH② CW1L-③1E01QH② CW1L-③1E11QH② CW1L-③1E20QH② CW1L-③1E02QH② CW1L-③1E22QH②	CW4L-③1E10QH② CW4L-③1E01QH② CW4L-③1E11QH② CW4L-③1E20QH② CW4L-③1E02QH② CW4L-③1E22QH②	
(metallic bezel)	230/240V AC	1NO 1NC 1NO-1NC 2NO 2NC 2NO-2NC	CW1L-③1E10QM4② CW1L-③1E01QM4② CW1L-③1E11QM4② CW1L-③1E20QM4② CW1L-③1E02QM4② CW4L-③1E22QM4②	CW4L-③1E10QM4② CW4L-③1E01QM4② CW4L-③1E11QM4② CW4L-③1E20QM4② CW4L-③1E02QM4② CW4L-③1E22QM4②	
	6V AC/DC	1NO 1NC 1NO-1NC 2NO 2NC 2NO-2NC	CW1L-③2E10Q2② CW1L-③2E01Q2② CW1L-③2E11Q2② CW1L-③2E20Q2② CW1L-③2E02Q2② CW1L-③2E22Q2②	CW4L-③2E10Q2② CW4L-③2E01Q2② CW4L-③2E11Q2② CW4L-③2E20Q2② CW4L-③2E02Q2② CW4L-③2E22Q2②	
Round Extended CW□L-□2	12V AC/DC	1NO 1NC 1NO-1NC 2NO 2NC 2NO-2NC	CW1L-③2E10Q3② CW1L-③2E01Q3② CW1L-③2E11Q3② CW1L-③2E20Q3② CW1L-③2E02Q3② CW1L-③2E22Q3②	CW4L-③2E10Q3② CW4L-③2E01Q3② CW4L-③2E11Q3② CW4L-③2E20Q3② CW4L-③2E02Q3② CW4L-③2E22Q3②	
	24V AC/DC	1NO 1NC 1NO-1NC 2NO 2NC 2NO-2NC	CW1L-③2E10Q4② CW1L-③2E01Q4② CW1L-③2E11Q4② CW1L-③2E20Q4② CW1L-③2E02Q4② CW1L-③2E22Q4②	CW4L-③2E10Q4② CW4L-③2E01Q4② CW4L-③2E11Q4② CW4L-③2E20Q4② CW4L-③2E02Q4② CW4L-③2E22Q4②	
(black bezel)	100/120V AC	1NO 1NC 1NO-1NC 2NO 2NC 2NO-2NC	CW1L-③2E10QH② CW1L-③2E01QH② CW1L-③2E11QH② CW1L-③2E20QH② CW1L-③2E02QH② CW1L-③2E22QH②	CW4L-③2E10QH② CW4L-③2E01QH② CW4L-③2E11QH② CW4L-③2E20QH② CW4L-③2E02QH② CW4L-③2E22QH②	
	230/240V AC	1NO 1NC 1NO-1NC 2NO 2NC 2NO-2NC	CW1L-③2E10QM4② CW1L-③2E01QM4② CW1L-③2E11QM4② CW1L-③2E20QM4② CW1L-③2E02QM4② CW4L-③2E22QM4②	CW4L-③2E10QM4② CW4L-③2E01QM4② CW4L-③2E11QM4② CW4L-③2E20QM4② CW4L-③2E02QM4② CW4L-③2E22QM4②	
(metallic bezel)					



1. Specify an illumination color code in place of ② in the Part Number.
2. Specify function code in place of ③ in the Part Number. M: momentary, A: maintained
3. See page 626 for dimensions.
4. See next page for replacement LED modules.
5. A dummy block is installed when one contact block is used.
6. Additional contact configurations available, contact IDEC for more details



(black bezel)



(metallic bezel)



(black bezel)



(metallic bezel)

Illuminated Pushbuttons (Sub-assembled)



Contact Blocks

Style	Contacts	Contact Block	Contact Configuration	Part Number
	Finger-safe screw terminal	Single	1NO	YW-E10R
			1NC	YW-E01
	Finger-safe screw terminal	Double	2NO	YW-EW2R0
			2NC	YW-EW02
			1NO-1NC	YW-EW1R1
	Dummy block			CW-DB

LED Module

Style	Part Number
	CW-EAQ ②①

- 1. In place of ①, specify the Lens/LED Color Code from table.
- 2. In place of ②, specify the Voltage Code from table.
- 3. Use PW LED for yellow lens.

Operators

Style			Black Bezel	Metallic Bezel
	Momentary	Round Flush	CW1L-M10	CW4L-M10
		Round Extended	CW1L-M20	CW4L-M20
	Maintained	Round Flush	CW1L-A10	CW4L-A10
		Round Extended	CW1L-A20	CW4L-A20

Lens

Style	Part Number
	Round Flush CW9Z-L11①
	Round Extended CW9Z-L12①

- 1. In place of ①, specify the Lens/LED Color Code from table.

Contact Block Mounting Adaptor

Style	Part Number
	CW-CN

① Lens/LED Color Code

Color	Code
Amber	A
Green	G
Red	R
Blue	S
White*	PW or C
Yellow	Y

*Use PW for LED module, use C for lens.

② Voltage Code

Voltage	Code
6V AC/DC	2
12V AC/DC	3
24V AC/DC	4
100/120V AC	H
230/240V AC	M4

Switches & Pilot Devices

Non-Illuminated Pushbuttons (Assembled)

Style	Contact Configuration	Black Bezel	Metallic Bezel	Button Color Code ①
Round Flush CW□B-□1  (black bezel)	1NO	CW1B-③1E10①	CW4B-③1E10①	B: black G: green R: red S: blue W: white Y: yellow
	1NC	CW1B-③1E01①	CW4B-③1E01①	
	1NO-1NC	CW1B-③1E11①	CW4B-③1E11①	
	2NO	CW1B-③1E20①	CW4B-③1E20①	
	2NC	CW1B-③1E02①	CW4B-③1E02①	
	2NO-1NC*	CW1B-M1E21①	CW4B-M1E21①	
	1NO-2NC*	CW1B-M1E12①	CW4B-M1E12①	
	3NO*	CW1B-M1E30①	CW4B-M1E30①	
	3NC*	CW1B-M1E03①	CW4B-M1E03①	
Round Extended CW□B-□2  (metallic bezel)	1NO	CW1B-③2E10①	CW4B-③2E10①	
	1NC	CW1B-③2E01①	CW4B-③2E01①	
	1NO-1NC	CW1B-③2E11①	CW4B-③2E11①	
	2NO	CW1B-③2E20①	CW4B-③2E20①	
	2NC	CW1B-③2E02①	CW4B-③2E02①	
	2NO-1NC*	CW1B-M2E21①	CW4B-M2E21①	
	1NO-2NC*	CW1B-M2E12①	CW4B-M2E12①	
	3NO*	CW1B-M2E30①	CW4B-M2E30①	
	3NC*	CW1B-M2E03①	CW4B-M2E03①	
2NO-2NC	CW1B-③2E22①	CW4B-③2E22①		

-  1. Specify a button color code in place of ① in the part number.
 2. Specify function code in place of ③ in the Part Number. M: momentary, A: maintained
 3. See page 627 for dimensions.
 4. Two dummy blocks are installed when one contact is used and one dummy block in installed when two contact blocks are used.
 5. *These contact configurations are not available in maintained action
 6. Additional contact configurations available; contact IDEC for more details.

Signaling Lights

Relays & Sockets



Timers

Non-Illuminated Pushbuttons (Sub-assembled)



Contact Blocks + Mounting Adaptor + Operator = Completed Unit



Contact Blocks

Style	Contacts	Contact Block	Contact Configuration	Part Number
	Finger-safe screw terminal	Single	1NO	YW-E10R
			1NC	YW-E01
		Double	2NO	YW-EW2R0
2NC	YW-EW02			
1NO-1NC	YW-EW1R1			
	Dummy block			CW-DB

Operators*

Style		Black Bezel	Metallic Bezel
	Momentary	Round Flush	CW1B-M1① / CW4B-M1①
		Round Extended	CW1B-M2① / CW4B-M2①
	Maintained	Round Flush	CW1B-A1① / CW4B-A1①
		Round Extended	CW1B-A2① / CW4B-A2①

① Button Color Code

Color	Code
Black	B
Green	G
Red	R
Blue	S
White	W
Yellow	Y

-  1. Specify a button color code in place of ①.
 2. *Operator button is not removable from operator.

Contact Block Mounting Adaptor

Style	Part Number
	CW-CN

Contactors

Terminal Blocks

Circuit Breakers

Pilot Lights (Assembled)

Style	Operating Voltage	Black Bezel	Metallic Bezel	Illumination Color Code ②
Round Flush Lens CW□P-1  (black bezel)	6V AC/DC	CW1P-1EQ2②	CW4P-1EQ2②	A: amber G: green R: red S: blue PW: white Y: yellow
	12V AC/DC	CW1P-1EQ3②	CW4P-1EQ3②	
	24V AC/DC	CW1P-1EQ4②	CW4P-1EQ4②	
	100/120V AC	CW1P-1EQH②	CW4P-1EQH②	
	230/240V AC	CW1P-1EQM4②	CW4P-1EQM4②	
Round Dome Lens CW□P-2  (metallic bezel)	6V AC/DC	CW1P-2EQ2②	CW4P-2EQ2②	
	12V AC/DC	CW1P-2EQ3②	CW4P-2EQ3②	
	24V AC/DC	CW1P-2EQ4②	CW4P-2EQ4②	
	100/120V AC	CW1P-2EQH②	CW4P-2EQH②	
	230/240V AC	CW1P-2EQM4②	CW4P-2EQM4②	

-  1. Specify an illumination color code in place of ② in the Part Number
 2. See page 627 for dimensions.
 3. See page 625 for replacement LED modules.
 4. Two dummy blocks are installed.

Pilot Lights (Sub-assembled)





 * 2 dummy blocks are required for each completed pilot light.

Contact Block

Style	Contacts	Part Number
	Dummy Block	CW-DB

LED Module

Style	Part Number
	CW-EAQ ②①

-  1. In place of ①, specify the Lens/LED Color Code from table.
 2. In place of ②, specify the Voltage Code from table.
 3. Use PW LED for yellow lens.



Contact Block Mounting Adaptor

Style	Part Number
	CW-CN

Operators

Style	Black Bezel	Metallic Bezel
	CW1P-00	CW4P-00

Lens

Style	Part Number
 Round Flush	CW9Z-L11①
 Round Dome	CW9Z-L15①

-  1. In place of ①, specify the Lens/LED Color Code from table.

① Lens/LED Color Code





Color	Code
Amber	A
Green	G
Red	R
Blue	S
White*	PW or C
Yellow	Y

② Voltage Code





Voltage	Code
6V AC/DC	2
12V AC/DC	3
24V AC/DC	4
100/120V AC	H
230/240V AC	M4

*Use PW for LED module, use C for lens.

Selector Switches (Assembled)

Shape	CW□S (Knob Operator)						
			(black bezel)		(metallic bezel)		
No. of Positions	Contact Configuration	Contact Block		Operator Position			
		Mounting Position	Type	L	R	Maintained	Spring return from right
90° 2-position	1NO (10)	1	NO		●	CW□S-2E10	CW□S-21E10
		2	—	Dummy			
		3	—	Dummy			
	1NC (01)	1	—	Dummy		CW□S-2E01	CW□S-21E01
		2	—	Dummy			
		3	NC	●			
	1NO-1NC (11)	1	NO		●	CW□S-2E11	CW□S-21E11
		2	—	Dummy			
		3	NC	●			
	2NO (20)	1	NO		●	CW□S-2E20	CW□S-21E20
		2	—	Dummy			
		3	NO		●		
	2NC (02)	1	NC	●		CW□S-2E02	CW□S-21E02
		2	—	Dummy			
		3	NC	●			
	2NO-1NC (21)	1	NO		●	CW□S-2E21	CW□S-21E21
		2	NO		●		
		3	NC	●			
	1NO-2NC (12)	1	NO		●	CW□S-2E12	CW□S-21E12
		2	NC	●			
		3	NC	●			
	3NO (30)	1	NO		●	CW□S-2E30	CW□S-21E30
		2	NO		●		
		3	NO		●		
3NC (03)	1	NC	●		CW□S-2E03	CW□S-21E03	
	2	NC	●				
	3	NC	●				
2NO-2NC (22)	1	NO/ NC	NC		●	CW□S-2E22	CW□S-21E22
	2	—	Dummy				
	3	NO/ NC	NO		●		
4NO (40)	1	2NO	NO		●	CW□S-2E40	CW□S-2E40
	2		NO		●		
	3	—	Dummy				
		3	2NO	NO		●	
			NO		●		

Selector Switches (Assembled) con't

No. of Positions	Contact Configuration	Contact Block		Operator Position			 Maintained	 Spring return from right	 Spring return from left	 Spring return two-way
		Mounting Position	Type	L	C	R				
45° 3-position	1NO-1NC (11)	1	NO	●			CW□S-3E11	CW□S-31E11	CW□S-32E11	CW□S-33E11
		2	—		Dummy					
		3	NC	■						
	1NO-1NC (11N1)	1	NC			■	CW□S-3E11N1	CW□S-31E11N1	CW□S-32E11N1	CW□S-33E11N1
		2	—		Dummy					
		3	NO			●				
	1NO-1NC (11N2)	1	NO	●			CW□S-3E11N2	CW□S-31E11N2	CW□S-32E11N2	CW□S-33E11N2
		2	NC		●					
		3	—		Dummy					
	1NO-1NC (11N3)	1	—		Dummy		CW□S-3E11N3	CW□S-31E11N3	CW□S-32E11N3	CW□S-33E11N3
		2	NC		●					
		3	NO			●				
	1NO-1NC (11N4)	1	—		Dummy		CW□S-3E11N4	CW□S-31E11N4	CW□S-32E11N4	CW□S-33E11N4
		2	NO	●		●				
		3	NC	■						
	2NO (20)	1	NO	●			CW□S-3E20	CW□S-31E20	CW□S-32E20	CW□S-33E20
		2	—		Dummy					
		3	NO			●				
	2NO (20N1)	1	—		Dummy		CW□S-3E20N1	CW□S-31E20N1	CW□S-32E20N1	CW□S-33E20N1
		2	NO	●		●				
		3	NO			●				
	2NC (02)	1	NC			■	CW□S-3E02	CW□S-31E02	CW□S-32E02	CW□S-33E02
		2	—		Dummy					
		3	NC	■						
	2NC (02N1)	1	—		Dummy		CW□S-3E02N1	CW□S-31E02N1	CW□S-32E02N1	CW□S-33E02N1
		2	NC		●					
		3	NC	■						
	2NO-1NC (21)	1	NO	●			CW□S-3E21	CW□S-31E21	CW□S-32E21	CW□S-33E21
		2	NO	●		●				
		3	NC	■						
2NO-1NC (21N1)	1	NO	●			CW□S-3E21N1	CW□S-31E21N1	CW□S-32E21N1	CW□S-33E21N1	
	2	NC		●						
	3	NO			●					
1NO-2NC (12)	1	NO	●			CW□S-3E12	CW□S-31E12	CW□S-32E12	CW□S-33E12	
	2	NC		●						
	3	NC	■							
1NO-2NC (12N1)	1	NC			■	CW□S-3E12N1	CW□S-31E12N1	CW□S-32E12N1	CW□S-33E12N1	
	2	NO	●		●					
	3	NC	■							
3NO (30)	1	NO	●			CW□S-3E30	CW□S-31E30	CW□S-32E30	CW□S-33E30	
	2	NO	●		●					
	3	NO			●					
3NC (03)	1	NC			■	CW□S-3E03	CW□S-31E03	CW□S-32E03	CW□S-33E03	
	2	NC		●						
	3	NC	■							

Switches & Pilot Devices

Signaling Lights

Relays & Sockets

Timers

Contactors

Terminal Blocks

Circuit Breakers

Selector Switches (Assembled) con't

No. of Positions	Contact Configuration	Contact Block		Operator Position			L C R Maintained	L C R Spring return from right	L C R Spring return from left	L C R Spring return two-way	
		Mounting Position	Type	L	C	R					
45° 3-position	2NO-2NC (22)	1	NO/NC NO/NC	●	■		CW□S-3E22	CW□S-31E22	CW□S-32E22	CW□S-33E22	
		2	—		■	Dummy					
		3	NO/NC NO/NC	■		●					
	4NO (40)	4NO (40)	1	2NO NO/NO	●			CW□S-3E40	CW□S-31E40	CW□S-32E40	CW□S-33E40
			2	—			Dummy				
			3	2NO NO/NO			●				
	2NO-2NC (22N2)	2NO-2NC (22N2)	1	2NC NC/NC		■	■	CW□S-3E22N2	CW□S-31E22N2	CW□S-32E22N2	CW□S-33E22N2
			2	—			Dummy				
			3	2NO NC/NC			●				

- 1. Specify a bezel color code in place of □ in the Part Number, 1 (black bezel), 4 (metallic bezel)
- 2. For the contact block mounting position, see below.
- 3. Lever operator is also available. For dimensions, see page 628.
- 4. To order a lever operator selector switch, insert L before E in the knob operator part number.
Example: Knob Operator part number CW1S-3E11 becomes CW1S-3LE11 for Lever Operator.

Lever Operator

Contact Block Mounting Position



CW1S-□L
(black bezel)



CW4S-□L
(metallic bezel)



		Left L	Center C	Right R	Operator Position
1	NO	●			
2	NC		●		
3	NC	■			

Selector Switches (Sub-assembled)

Contact Block + Mounting Adaptor + Operator = Completed Unit



Contact Blocks

Style	Contacts	Contact Block	Contact Configuration	Part Number
	Finger-safe screw terminal	Single	1NO	YW-E10R
			1NC	YW-E01
	Finger-safe screw terminal	Double	2NO	YW-EW2R0
			2NC	YW-EW02
			1NO-1NC	YW-EW1R1
	Dummy block			CW-DB

Contact Block Mounting Adaptor

Style	Part Number
	CW-CN

Operators





Style	Position	Handle	Description	Black Bezel	Metallic Bezel
	2-position	Knob	Maintained	CW1S-2	CW4S-2
			Spring return from right	CW1S-21	CW4S-21
		Lever	Maintained	CW1S-2L	CW4S-2L
			Spring return from right	CW1S-21L	CW4S-21L
 (knob operator shown)	3-position	Knob	Maintained	CW1S-3	CW4S-3
			Spring return from right	CW1S-31	CW4S-31
			Spring return from left	CW1S-32	CW4S-32
			Spring return two-way	CW1S-33	CW4S-33
		Lever	Maintained	CW1S-3L	CW4S-3L
			Spring return from right	CW1S-31L	CW4S-31L
			Spring return from left	CW1S-32L	CW4S-32L
			Spring return two-way	CW1S-33L	CW4S-33L

Lever or knob is supplied with operator.

Key Selector Switches (Assembled)

Shape	CW□K		Contact Block		Operator Position		 Maintained	 Spring return from right	
	No. of Positions	Contact Configuration	Mounting Position	Type	L	R			
90° 2-position	1NO (10)	1	NO			●	CW□K-2AE10	CW□K-21BE10	
		2	—	Dummy					
		3	—	Dummy					
	1NC (01)	1	—	Dummy				CW□K-2AE01	CW□K-21BE01
		2	—	Dummy					
		3	NC	●					
	1NO-1NC (11)	1	NO			●	CW□K-2AE11	CW□K-21BE11	
		2	—	Dummy					
		3	NC	●					
	2NO (20)	1	NO			●	CW□K-2AE20	CW□K-21BE20	
		2	—	Dummy					
		3	NO			●			
	2NC (02)	1	NC	●			CW□K-2AE02	CW□K-21BE02	
		2	—	Dummy					
		3	NC	●					
	2NO-1NC (21)	1	NO			●	CW□K-2AE21	CW□K-21BE21	
		2	NO			●			
		3	NC	●					
	1NO-2NC (12)	1	NO			●	CW□K-2AE12	CW□K-21BE12	
		2	NC	●					
		3	NC	●					
	3NO (30)	1	NO			●	CW□K-2AE30	CW□K-21BE30	
		2	NO			●			
		3	NO			●			
3NC (03)	1	NC	●			CW□K-2AE03	CW□K-21BE03		
	2	NC	●						
	3	NC	●						
2NO-2NC (22)	1	NO/NC		NO		●	CW□K-2AE22	CW□K-21BE22	
	2	—	Dummy						
	3	NO/NC		NO		●			
4NO (40)	1	2NO		NO		●	CW□K-2AE40	CW□K-21BE40	
	2	—	Dummy						
	3	2NO		NO		●			

Key Selector Switches (Assembled) con't

No. of Positions	Contact Configuration	Contact Block		Operator Position						
		Mounting Position	Type	L	C	R	Maintained	Spring return from right	Spring return from left	Spring return two-way
45° 3-position	1NO-1NC (11)	1	NO	●			CW□K-3AE11	CW□K-31BE11	CW□K-32CE11	CW□K-33DE11
		2	—		Dummy					
		3	NC	■						
	1NO-1NC (11N1)	1	NC		■		CW□K-3AE11N1	CW□K-31BE11N1	CW□K-32CE11N1	CW□K-33DE11N1
		2	—		Dummy					
		3	NO			●				
	1NO-1NC (11N2)	1	NO	●			CW□K-3AE11N2	CW□K-31BE11N2	CW□K-32CE11N2	CW□K-33DE11N2
		2	NC		●					
		3	—		Dummy					
	1NO-1NC (11N3)	1	—		Dummy		CW□K-3AE11N3	CW□K-31BE11N3	CW□K-32CE11N3	CW□K-33DE11N3
		2	NC		●					
		3	NO			●				
	1NO-1NC (11N4)	1	—		Dummy		CW□K-3AE11N4	CW□K-31BE11N4	CW□K-32CE11N4	CW□K-33DE11N4
		2	NO	●		●				
		3	NC	■						
	2NO (20)	1	NO	●			CW□K-3AE20	CW□K-31BE20	CW□K-32CE20	CW□K-33DE20
		2	—		Dummy					
		3	NO			●				
	2NO (20N1)	1	—		Dummy		CW□K-3AE20N1	CW□K-31BE20N1	CW□K-32CE20N1	CW□K-33DE20N1
		2	NO	●		●				
		3	NO			●				
	2NC (02)	1	NC		■		CW□K-3AE02	CW□K-31BE02	CW□K-32CE02	CW□K-33DE02
		2	—		Dummy					
		3	NC	■						
	2NC (02N1)	1	—		Dummy		CW□K-3AE02N1	CW□K-31BE02N1	CW□K-32CE02N1	CW□K-33DE02N1
		2	NC		●					
		3	NC	■						
	2NO-1NC (21)	1	NO	●			CW□K-3AE21	CW□K-31BE21	CW□K-32CE21	CW□K-33DE21
		2	NO	●		●				
		3	NC	■						
2NO-1NC (21N1)	1	NO	●			CW□K-3AE21N1	CW□K-31BE21N1	CW□K-32CE21N1	CW□K-33DE21N1	
	2	NC		●						
	3	NO			●					
1NO-2NC (12)	1	NO	●			CW□K-3AE12	CW□K-31BE12	CW□K-32CE12	CW□K-33DE12	
	2	NC		●						
	3	NC	■							
1NO-2NC (12N1)	1	NC		■		CW□K-3AE12N1	CW□K-31BE12N1	CW□K-32CE12N1	CW□K-33DE12N1	
	2	NO	●		●					
	3	NC	■							
3NO (30)	1	NO	●			CW□K-3AE30	CW□K-31BE30	CW□K-32CE30	CW□K-33DE30	
	2	NO	●		●					
	3	NO			●					
3NC (03)	1	NC		■		CW□K-3AE03	CW□K-31BE03	CW□K-32CE03	CW□K-33DE03	
	2	NC		●						
	3	NC	■							

Switches & Pilot Devices

Signaling Lights

Relays & Sockets

Timers

Contactors

Terminal Blocks

Circuit Breakers

Key Selector Switches (Assembled) con't

No. of Positions	Contact Configuration	Contact Block		Operator Position			L C R Maintained	L C R Spring return from right	L C R Spring return from left	L C R Spring return two-way
		Mounting Position	Type	L	C	R				
90° 2-position	2NO-2NC (22)	1	NO/NC	NO NC	●		CW□K-3AE22	CW□K-31BE22	CW□K-32CE22	CW□K-33DE22
		2	—			Dummy				
		3	NO/NC	NO NC		●				
	4NO (40)	1	2NO	NO NO	●		CW□K-3AE40	CW□K-31BE40	CW□K-32CE40	CW□K-33DE40
		2	—			Dummy				
		3	2NO	NO NO		●				
	2NO-2NC (22N2)	1	2NC	NC NC		●	CW□K-3AE22N2	CW□K-31BE22N2	CW□K-32CE22N2	CW□K-33DE22N2
		2	—			Dummy				
		3	2NC	NC NC		●				



- Specify a bezel color code in place of □ in the Part Number: 1 (black bezel), 4 (metallic bezel).
- On the spring-returned models, the key can be released only from the maintained position. On the maintained models, the key can be released from any position. Key retained positions are also available. See below.
- Two keys are supplied.
- Key cylinder material: Metal
- Besides the standard key (key number 0H), six other keys are also available. See below.
- For the contact block mounting position, see right.
- For dimensions, see page 629.
- When ordering an optional key or optional key-retained positions, specify designation codes as shown below:
Example: CW1K-2AE10-1H

blank: Standard key (0H, reversible)
 1H to 2H: Reversible key
 3H to 6H: Non-reversible key
 Key removal position code
 2-position
 A: Removable in all positions
 B: Removable in left only
 C: Removable in right only

Contact Block Mounting Position



		Left	Center	Right	Operator Position
		L	C	R	
1	NO	●			
2	NC		●		
3	NC		●		

Note:
Key number is indicated on the key cylinder.
Standard keys do not have a key number indication.

- 3-position
- A: Removable in all positions
 - B: Removable in left and center
 - C: Removable in right and center
 - D: Removable in center only
 - E: Removable in right and left
 - G: Removable in left only
 - H: Removable in right only

Note: Key is retained in all spring-returned positions.

Key Selector Switches (Sub-assembled)

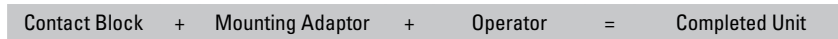

Contact Blocks

Style	Contacts	Contact Block	Contact Configuration	Part Number
	Finger-safe screw terminal	Single	1NO	YW-E10R
			1NC	YW-E01
	Finger-safe screw terminal	Double	2NO	YW-EW2R0
			2NC	YW-EW02
			1NO-1NC	YW-EW1R1
	Dummy block			CW-DB

Contact Block Mounting Adaptor



Style	Part Number
	CW-CN

Operator

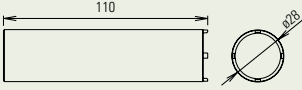

Style	Position	Description	Black Bezel	Metallic Bezel
	2-position	Maintained, key removable all positions	CW1K-2A	CW4K-2A
		Maintained, key removable left position only	CW1K-2B	CW4K-2B
		Maintained, key removable right position only	CW1K-2C	CW4K-2C
		Spring return from right	CW1K-21B	CW4K-21B
	3-position	Maintained, key removable all positions	CW1K-3A	CW1K-3A
		Maintained, key removable left and center positions only	CW1K-3B	CW4K-3B
		Maintained, key removable right and center positions only	CW1K-3C	CW4K-3C
		Maintained, key removable center position only	CW1K-3D	CW4K-3D
		Maintained, key removable left and right positions only	CW1K-3E	CW4K-3E
		Maintained, key removable left position only	CW1K-3G	CW4K-3G
		Maintained, key removable right position only	CW1K-3H	CW4K-3H
		Spring return from right, key removable left and center positions only	CW1K-31B	CW4K-31B
		Spring return from right, key removable center position only	CW1K-31D	CW4K-31D
		Spring return from right, key removable left position only	CW1K-31G	CW4K-31G
		Spring return from left, key removable right and center positions only	CW1K-32C	CW4K-32C
		Spring return from left, key removable center position only	CW1K-32D	CW4K-32D
Spring return from left, key removable right position only	CW1K-32H	CW4K-32H		
Spring return two-way, key removable center position only	CW1K-33D	CW4K-33D		

Two keys supplied with operator.

Accessories

Item	Appearance	Material	Part Number	Remarks
Locking Ring Wrench		Brass	MW9Z-T1	<ul style="list-style-type: none"> Used to tighten the locking ring when installing the CW series control unit in a panel cut-out Weight: Approx 150g 
Mounting Hole Plug		Polyamide (black)	LW9Z-BP1	<ul style="list-style-type: none"> Used to plug an unnecessary ø22.3mm hole in the panel Degree of protection: IP65 Panel thickness: 0.8 to 6.0mm

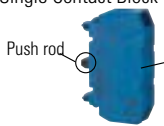
Replacement Parts

Shape	Material	Part Number	Remarks
Lens 	1 Round Flush	Polyallylate	CW9Z-L11Ⓢ
	2 Round Extended	Polyallylate	CW9Z-L12Ⓢ
	3 Round Dome	Polyallylate	CW9Z-L15Ⓢ
Single Contact Block 	1NO		YW-E10R
	1NC		YW-E01
	Double Contact Block 	2NO	
Double Contact Block 	2NC		YW-EW02
	1NO, 1NC		YW-EW1R1
	Rubber Boot 	Round Flush	
Round Extended			CW9Z-D12
Dummy Block	Polyamide (black)		CW-DB
Locking Ring	Polyamide (black)		CW9Z-LN
Gasket	Nitrile rubber		CW9Z-WM
Nameplate	Plastic		CWAM-OB
Spare Key	Zinc (nickel-plated)		LA9Z-SK-□

Specify a key No. in place of □.
 0H: Standard key (reversible)
 1H to 2H: Reversible key
 3H to 6H: Non-reversible key
 For dimensions, see page 629.

LED Modules

Shape	Operating Voltage Range	Current Draw	Part Number	Illumination Color Code ②
	6V AC/DC±10%	15mA	CW-EAQ2②	Specify an illumination color code in place of ② in the Part Number A: amber G: green PW: white R: red S: blue
	12V AC/DC±10%	15mA	CW-EAQ3②	
	24V AC/DC±10%	16.5mA	CW-EAQ4②	
	100/120V AC±10%	18mA	CW-EAQH②	
	230/240V AC±10%	18mA	CW-EAQM4②	

Nameplate

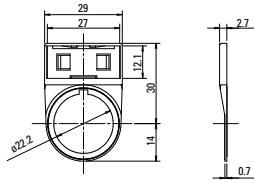

Nameplate (blank engraving plate included)	CWAM-OB	
Nameplate (engraved)	CWAM-①	
Additional Insert (blank)	HWNP-O	HWNP Dimensions
Additional Insert (engraved)	HWNP-①	

- In place of ①, insert either the standard legend code from table below or custom engraving delimited by " ".
- Standard engravings are available at no charge.

Standard Legend Codes

Pushbuttons				Pushbuttons/Selector Switches				Selector Switches	
Legend	Code	Legend	Code	Legend	Code	Legend	Code	Legend	Code
AUTO	101	OPEN	116	AUTO-MAN	201	REV-FOR	216	AUTO-MAN-OFF	301
CLOSE	102	OUT	117	CLOSE-OPEN	202	RUN-JOG	217	AUTO-OFF-MAN	302
DOWN	103	RAISE	118	DOWN-UP	203	RUN-SAFE	218	CLOSE-OFF-OPEN	303
EMERG.	104	RESET	119	FAST-SLOW	204	SAFE-RUN	219	DOWN-OFF-SLOW	304
STOP	105	REVERSE	120	FOR-REV	205	SLOW-FAST	220	FAST-OFF-SLOW	305
FAST	106	RUN	121	HAND-AUTO	206	START-STOP	221	FOR-OFF-REV	306
FORWARD	107	SLOW	122	HIGH-LOW	207	STOP-START	222	LEFT-OFF-RIGHT	307
HAND	108	START	123	JOG-RUN	208	UP-DOWN	223	LOWER-OFF-RAISE	308
HIGH	109	STOP	125	LEFT-RIGHT	209	OI (Int'l OFF ON)	250	OFF-MAN-AUTO	309
IN	110	TEST	126	LOWER-	210			OFF-SLOW-FAST	310
INCH	111	UP	127	RAISE	211			OFF-1-2	311
JOG	112	I (Int'l On)	150	MAN-AUTO	212			OPEN-OFF-CLOSE	312
LOW	113	O (Int'l Off)	151	OFF-ON	213			SLOW-OFF-FAST	313
LOWER	114	Off	152	ON-OFF	214			SUMMER-OFF-WINTER	314
OFF	115	EMO		OPEN-CLOSE	215			UP-OFF-DOWN	315
ON				RAISE-LOWER				1-OFF-2	316
								HAND-OFF-AUTO	317

- To order engraved nameplates, add legend code to nameplate part number.
- Character height based on the number of characters and size of nameplate. Standard character size is 3/16".
- Nameplates with standard legends are the same list price as blank nameplates.

Nameplates Order Form – CW Series

Copy this order form and use it to specify Letter Height, Custom Engravings, Location of Engraving on Nameplate, and Quantity Desired. To ensure engraving accuracy, fax it to your IDEC representative or Distributor.

Your Company: _____

Name: _____

Telephone: _____

Fax & Email: _____

IDEC Rep/Distributor Contact: _____

PO number (if known): _____

IDEC Rep/Distributor Phone: _____

IDEC Rep/Distributor Fax & Email: _____

CWAM Nameplate

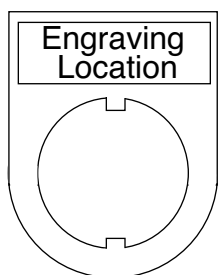

Step 1. Choose Letter Size - 7/64" or 1/8".
Check the box for the letter size you want. Then write your lettering in box below the check boxes. Note: 1/8" size letters cannot exceed 9 characters.

7/64" Letter Size 11 characters maximum (for 7/64" size letters)

1/8" Letter Size 9 characters maximum (for 7/8" size letters)

Qty

1 2 3 4 5 6 7 8 9 10 11

Step 2. Specify Quantity.
Enter the number of nameplates desired in the box on the right.

Sample Letter Sizes
7/64" Letters: A B C D
1/8" Letters: A B C D

Dimensions (mm)

Illuminated Pushbuttons

1 to 3 Contacts

Round Flush

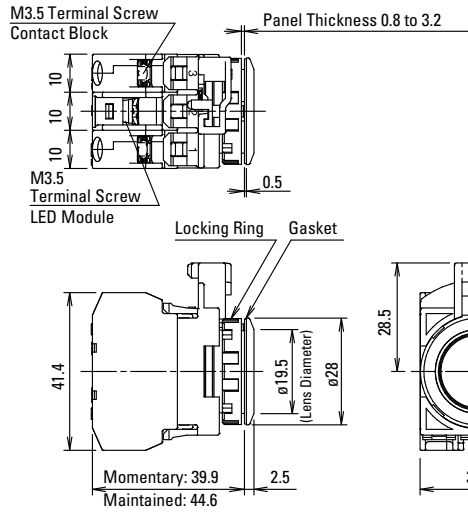

Round Extended

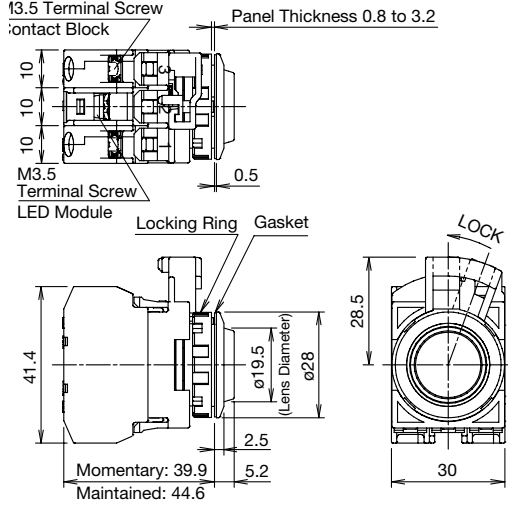

4 to 6 Contacts

Round Flush

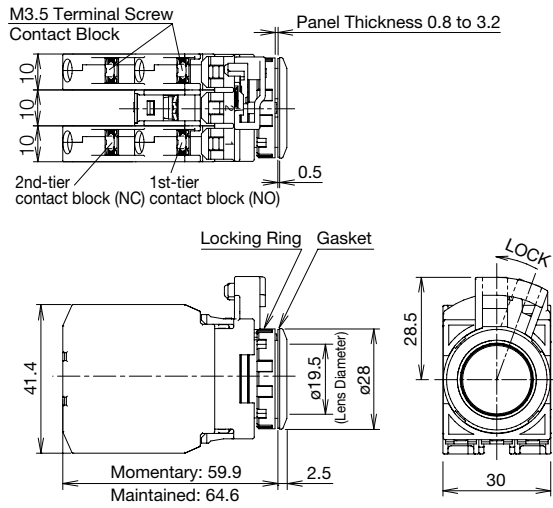

Round Extended

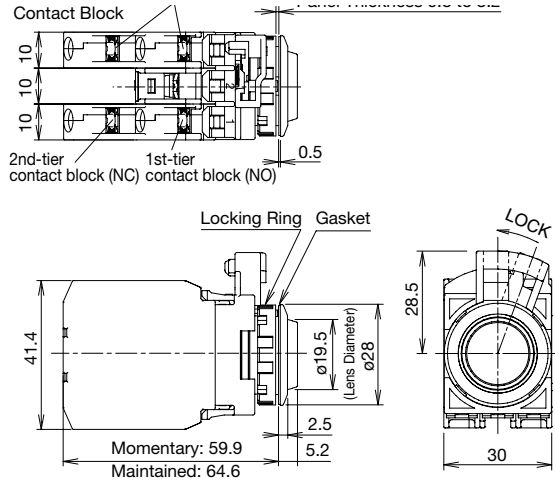

Pushbuttons

1 to 3 Contacts

Round Flush

M3.5 Terminal Screw
Contact Block

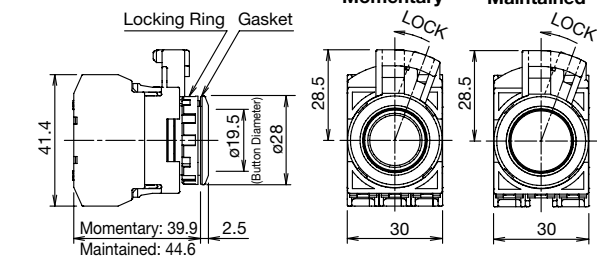
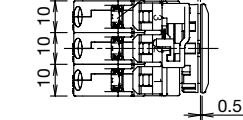

Round Extended

M3.5 Terminal Screw
Contact Block

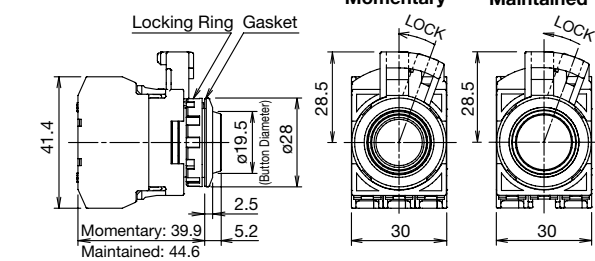
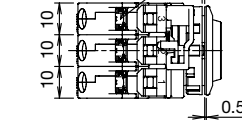

4 to 6 Contacts

Round Flush

M3.5 Terminal Screw
Contact Block

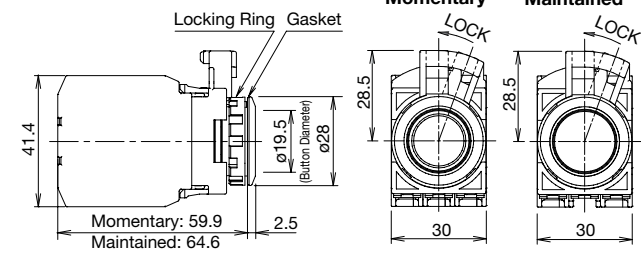
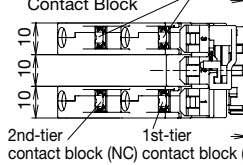

Round Extended

M3.5 Terminal Screw
Contact Block

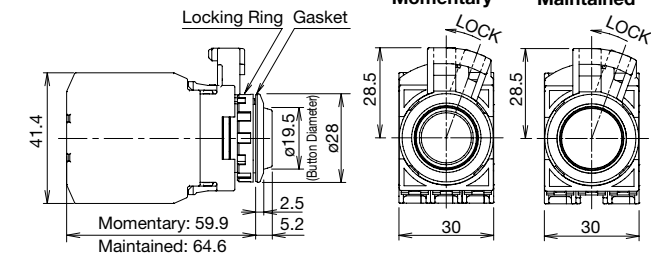
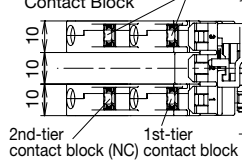

Round Flush

M3.5 Terminal Screw
LED Module

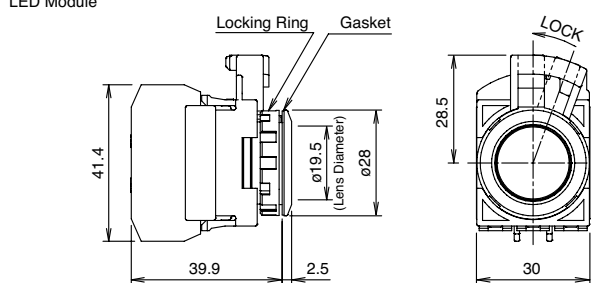
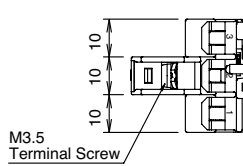

Round Dome

M3.5 Terminal Screw
LED Module

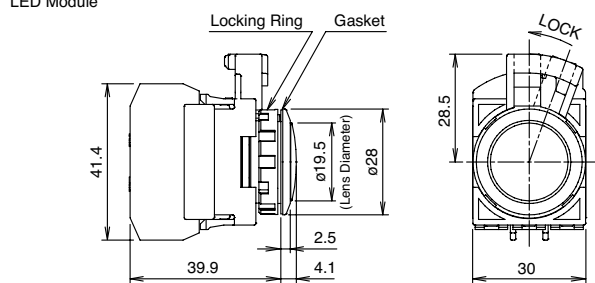
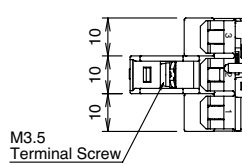

Selector Switches

1 to 3 Contacts

Knob Operator

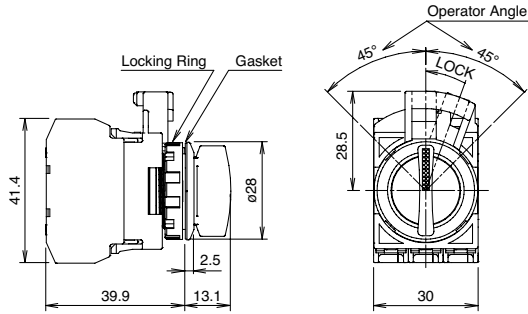
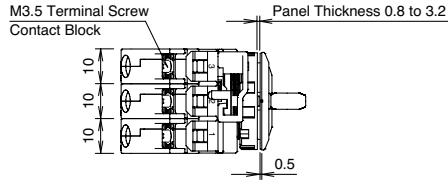

Lever Operator

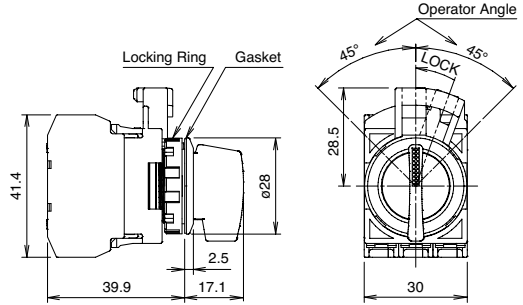
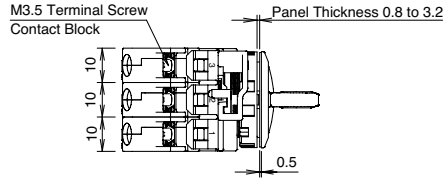

4 to 6 Contacts

Knob Operator

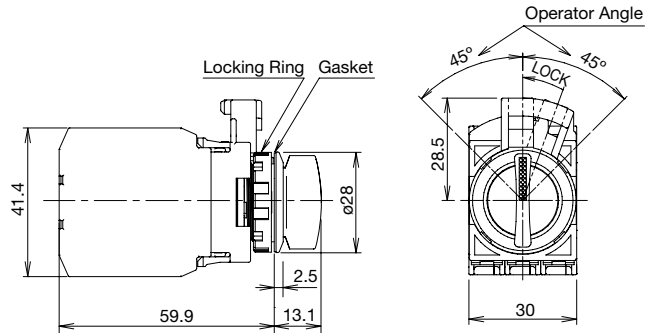
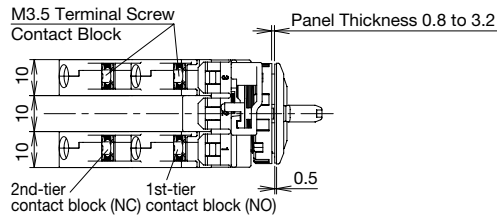

Lever Operator

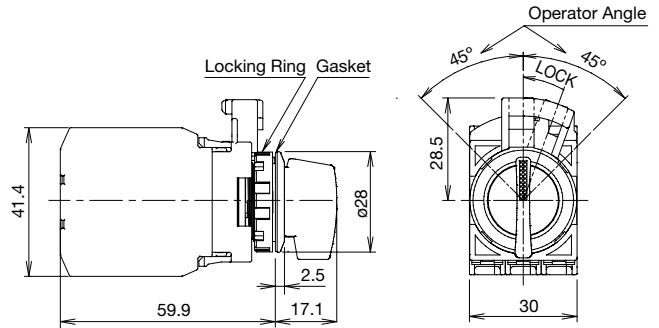
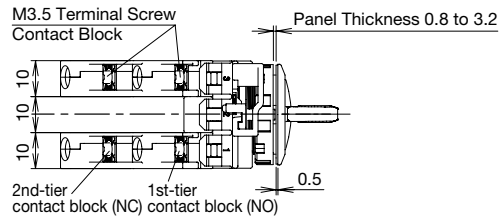

Key Selector Switches

1 to 3 Contacts

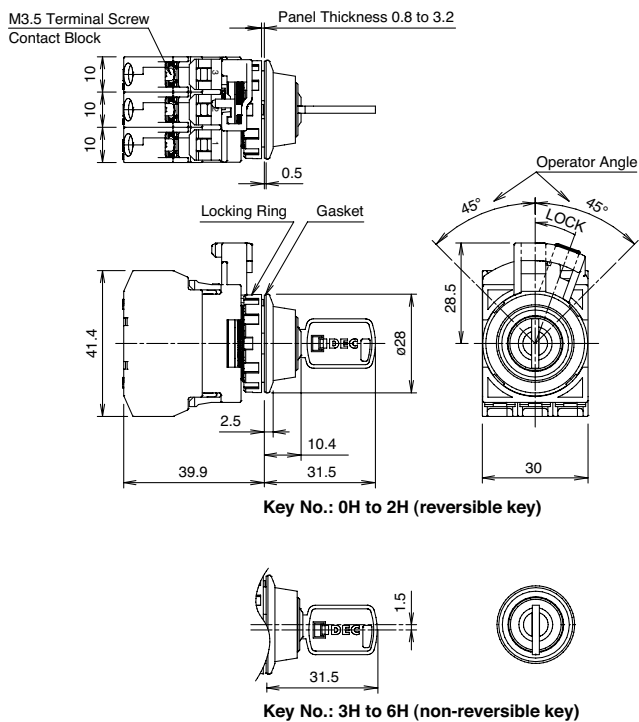

Keys

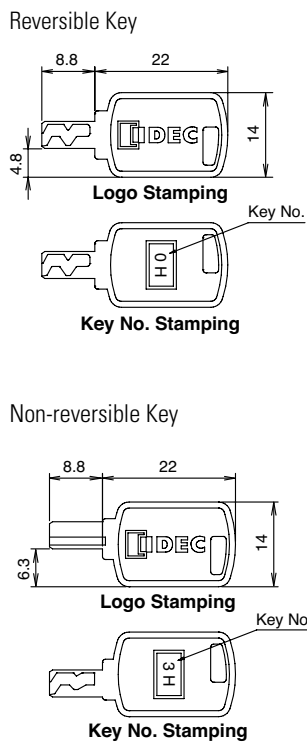

4 to 6 Contacts

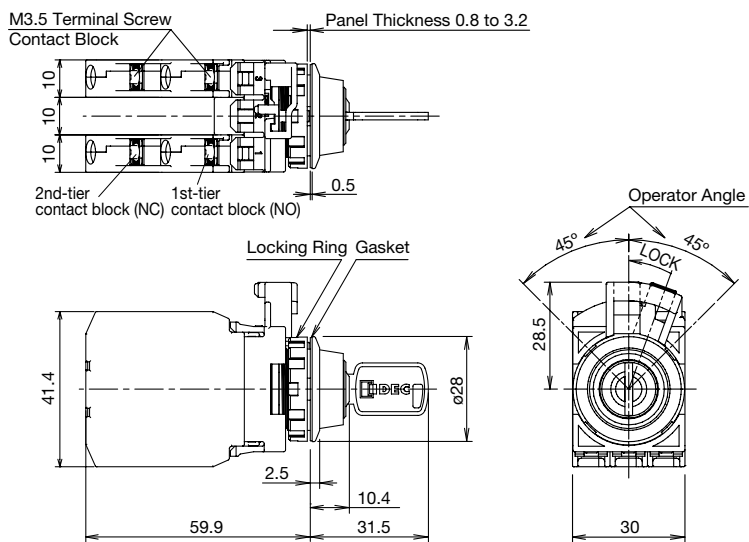

Safety Precautions

Turn off the power to CW series switches before installation, removal, wiring and maintenance. Failure to turn power off may cause electrical shocks or fire hazard.

When wiring, use wires of a proper size to meet the voltage and current requirements. Tighten the M3.5 terminal screws to a tightening torque of 1.0 to 1.3 N·m. Failure to tighten the terminal screws may cause overheating and fire.

Operating Instructions

Notes for Operation

When using the CW series switches in a safety-related circuit of a control system, observe safety rules and regulations of each country concerning particular applications of the actual machines and facilities. Perform risk assessment before operation to ensure safety.

Operating Conditions

In corrosive gas or high-temperature, high-humidity environments, contact failure due to corrosion or color change or breakage of the housing may occur.

Main parts of the CW series switches are made of plastic. Do not scratch the surface with a sharp object or apply excessive electric shock or load, otherwise the switches may be damaged. In particular, keep the button, lens and bezel from such damage, otherwise appearance and function may be impaired.

Do not apply detergents, cutting oils, or chemicals which may impair the function and appearance of the CW series switches.

Panel Mounting

First remove the contact block and then the locking ring from the operator. Insert the operator into the panel cut-out from the front, tighten the locking ring from the back, then install the contact block to the operator.

Mounting Hole

1. Mounting hole dimensions are in compliance with IEC60947-5-1.
2. If the anti-rotation projection is removed from the bezel, CW series switches can be mounted in ø22.3mm mounting holes. To remove the anti-rotation projection, remove the gasket and use cutting pliers to break the projection.

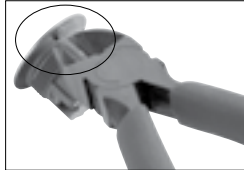

Removing and Installing the Contact Unit

1. To remove the contact block from the operator, push the yellow locking lever and turn it to the left.

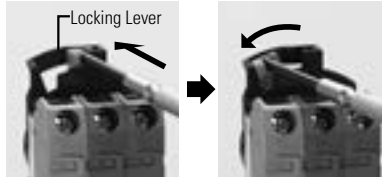

2. To install, align the TOP marking on the operator with the TOP marking on the contact block mounting adaptor, and turn the locking lever to the right.

Installation in Panel Cut-out

Remove the locking ring from the operator. With the anti-rotation projection on the operator aligned with the recess in the mounting hole, insert the operator into the mounting hole. Tighten the locking ring from the rear of the panel.

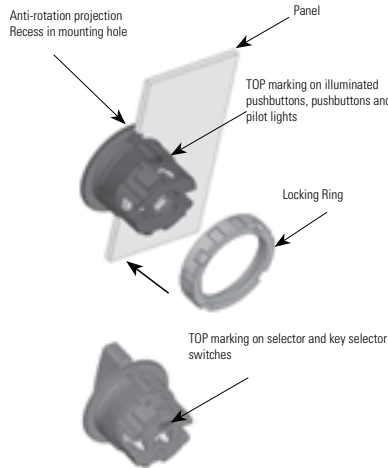

Note for Panel Mounting

When installing the operator in a panel cut-out, use the optional locking ring wrench (MW9Z-T1) to tighten the locking ring to a recommended tightening torque of 1.2 N·m. Do not use pliers and do not tighten excessively, otherwise the operator may be damaged.

Illuminated Pushbuttons and Pilot Lights

Removing the Lens

To remove the lens from an illuminated pushbutton or pilot light, insert a flat screwdriver under the flange of the lens at 90° from the TOP marking and twist the screwdriver.

Do not insert the screwdriver too far and do not apply excessive force to the lens, otherwise the bezel surface may be damaged.

Screwdriver Insertion Direction

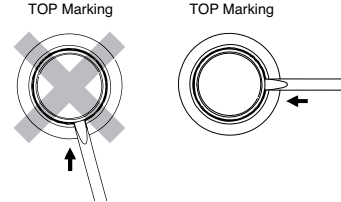

Screwdriver Insertion Angle

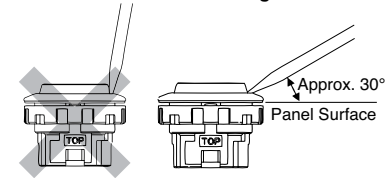

Installing the Lens

Turn the groove in the lens to the TOP marking on the operator housing. With the groove aligned with the ridge, press the lens in.

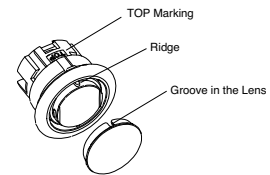

Marking

Marking film can be applied for inscriptions or identification.

Applicable Marking Film Size

Illuminated Pushbutton (Round Flush) Pilot Light (Round Flush, Round Extended)	Illuminated Pushbutton (Round Extended)

Thickness: 0.2mm maximum
 Film material: Polyester (recommended)
 Note: Film is not supplied and must be provided by the user.

Operating Instructions, con't

Pushbuttons

Pushbutton caps cannot be removed. Do not tamper with the cap using a screwdriver or pliers, otherwise it may be damaged.

Selector Switches

Turn the selector operator or key to the detent positions.

Key Selector Switches

To prevent malfunction and damage, take the following precautions.

- Completely insert the key before turning.
- Do not remove the key while turning.
- Besides the standard key (0H), six other keys are available. Use only a key with a number that matches the number on the switches' key cylinder. (The standard key does not have a key number.)
- Keys are available in two shapes.
 - 0H (standard), 1H, 2H: reversible keys
 - 3H, 4H, 5H, 6H: non-reversible keys
 Make sure of correct insertion direction.

Contact Blocks and LED Modules

To remove the contact block from the operator, insert a flat screwdriver under the latch and push the screwdriver down as shown below. Before removing the LED module, first remove all contact blocks, and then remove the LED module in the same manner.

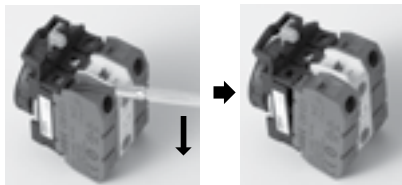

Wiring

Applicable Wires

Stranded wire: 2.0 mm² maximum (14AWG)
Solid wire: ø1.6 mm maximum

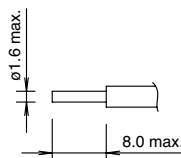

One or two wires can be connected to the terminal.

Applicable Crimping Terminals

Spade terminal

When using crimping terminals, be sure to use insulating tubes or insulated crimping terminals.

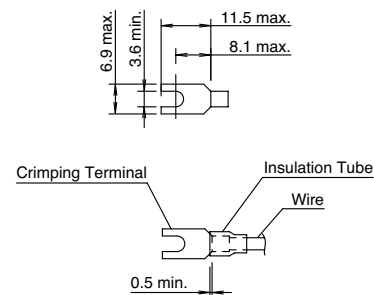

Ferrule

When connecting two ferrules to one terminal, use ferrules without insulation.

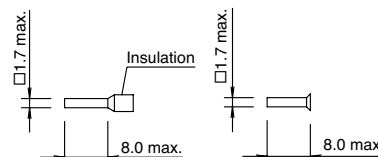

When using spade terminals or ferrules, ensure that they are inserted completely. Ring terminals cannot be used.

Screw Tightening Torque

Tighten the M3.5 terminal screws to a recommended torque of 1.0 to 1.3N·m.

HW Series – 22mm IEC Style Global Pushbuttons

Key features:

- Locking lever removable contact blocks
- Finger-safe IP20 contacts
- Tamperproof construction
- All E-stops meet EN60947-5-5, and are compliant with SEMI S2 standards
- Worldwide approvals
- Easy to assemble
- Choice of black plastic or metallic front bezels
- LED illumination
- Transformer or full voltage
- Slow make double break contacts



HW: The Best Engineered Switch in the World

IDEC's HW switches are "The best engineered switch in the world" for a reason. Carrying the CE mark, UL, CSA, CCC (Chinese), and TUV approvals, these switches are designed for use in almost any part of the world.

include illuminated and non-illuminated pushbuttons, pilot lights, selector switches, and emergency stop switches.

Complete with finger-safe contact blocks offering IP20 protection, these 7/8" (22mm) switches

All switches also incorporate mechanically keyed safety locking levers, ensuring correct installation and maintaining safety in high-vibration applications.



File No. E68961



File No. LR21451



TUV Rheinland Certificate No. R50086203_HW_e-stop R50391189_HW



Certificate No. 2017010305987846

Specifications

Electrical	Rated Operational Characteristics	AC-15: A600 or Ue = 250V, Ie = 3A (NO, NC, NO-EM, NC-LB) DC-13: P600 or Ue = 125V, Ie = 1.1A (NO, NC) DC-13: Q600 or Ue = 125V, Ie = 0.9A (NO-EM, NC-LB)					
	Rated Insulation Voltage	600V					
	Rated Switching Over-Voltage	Less than 4kV, conforming to IEC60947-1					
	Rated Impulse Withstanding Voltage	4kV for contact circuit, 2.5kV for lamp circuit					
	Rated Thermal Current	10 Amp					
	Minimum Switching Capacity	5 mA at 3V AC/DC					
	Electrical Reliability	MTBF < 1 fault for 10 million operation cycles (3V DC, 5mA)					
	Lamp Ratings	LEDs: 6V/17mA max, 12V & 24V/11mA max, 120 & 240V/10mA max					
Mechanical	Contact Operation	Slow break NC or NO					
	Positive Action Operation (Emergency Stops with NC contacts)	5.5mm to 10mm travel to latch, 45N minimum force to latch 10mm maximum travel, 1,800 operations per hour maximum for a Pushlock Turn Reset 900 operations per hour maximum for a Push-Pull					
	Operating Force	Flush and extended pushbuttons—with 1NO or 1NC contact: 6.2±2N (momentary), 7.0±2N (maintained) Additional contacts—1NO or 1NC: +3.2N (momentary), + 3.3N (maintained)					
	Recommended Terminal Torque	Unit	Wire	Number of Wires	Recommended Tightening Torque (Nm)	Terminal Screw	
							Crimping Terminal
		HW-U Contact Block	Solid Wire	ø0.5 to 1.6 mm (AWG14 to 22)	2	1.0 to 1.3	
			Stranded Wire	0.3 to 2.0 mm ² (AWG14 to 22) 2.1 to 3.5 mm ² (AWG12)	1 2	1.2 to 1.3 1.0 to 1.3	
	Illuminated Unit (*1)	Unit	Wire	Number of Wires	Recommended Tightening Torque (Nm)	Terminal Screw	
							Crimping Terminal
	Applicable Wire Size	Pilot Light	Wire	Number of Wires	Recommended Tightening Torque (Nm)	Terminal Screw	
Crimping Terminal							2
1. * refers to the lamp terminals of the illuminated push buttons and selector switches.							
Applicable Wire Size	Minimum 1 x 22 AWG, max. 2 x 14 AWG or 1 x 12 AWG						
Contact Resistance	Initial contact resistance of 50mΩ or less						
Contact Gap	4mm (NO and NC), 2mm (NO-EM and NC-LB)						
Horsepower Rating	Reference Value: 1/4 HP @ 120V (1ø non-reversing), 1HP @ 240V (3ø non-reversing)						
Contact Material	Silver (gold plated contacts available - contact IDEC)						
Operating Temperature	Operation: -25 to +60°C (illuminated -25 to +50°C dome -25 to +55°C)						
Vibration Resistance	10 to 55Hz, 98m/sec ² (10G) conforming to IEC6068-2-6						
Shock Resistance	980m/sec ² (100G) conforming to IEC6068-2-7						
Mechanical Life	Momentary pushbuttons: 5,000,000 (900 operations per hour), All other switches: 500,000						

Switches & Pilot Devices

Signaling Lights





Relays & Sockets

Timers

Contactors





Terminal Blocks

Circuit Breakers

Conforming to Standards		EN60947-1, EN60947-5-1, VDE0660-200, UL508, CSA C22-2 No.14							
Standards & Approvals	 File No. E68961  File No. LR92374    Registration No. R9551089 (E-stops) Registration No. R50054316 (Dual Pushbuttons) Registration No. J9650511 (Pilot Lights) Registration No. J9551458 (all other switches)		CSA: pushbuttons and selector switches: A600 pilot lights and illuminated pushbuttons, direct supply pilot lights and illuminated pushbuttons with integral transformer (100/110, 115, 120, 200/220, 230, 240, 380, 400/440, 480V) UL: pushbuttons and selector switches: A600 pilot lights and illuminated pushbuttons, direct supply pilot lights and illuminated pushbuttons with integral transformer (100/110, 115, 120, 200/220, 230, 240, 380, 400/440, 480V) TÜV: pushbuttons and selector switches: A600=P600 (NO, NC)/O600 (NO-EM, NC-LB) pilot lights and illuminated pushbuttons, direct supply pilot lights and illuminated pushbuttons with integral transformer (100/110, 115, 120, 200/220, 230, 240, 380, 400/440, 480V)						
	Electric Shock Protection		Class 2 conforming to IEC60664-7						
	Degree of Protection (conforming to IEC60529 and UL50)		UL Type 1, 4X, 12, 13 ¹ IP65 (from front of the panel) IP20 (Type HW-U contact block)						
	Pollution Degree (conforming to IEC60947-1)		3						
	External Short-Circuit Protection		10A 250V fuse conforming to IEC60269-1						
Contact Ratings	Pushbuttons Illuminated Pushbuttons Selector Switches Illuminated Selector Switches Pushbutton Selectors		Contact Block			Type HW-U			
			Rated Insulation Voltage			600V			
			Rated Continuous Current			10A			
			Contact Ratings by Utilization Category IEC 60947-5-1			AC-15 (A600) DC-13 (P600)			
Characteristics	Operational Voltage		24V	48V	50V	110V	220V	440V	
	Operational Current	AC 50/60 Hz	AC-12 Control of resistive loads & solid state loads	10A	—	10A	10A	6A	2A
			AC-15 Control of electromagnetic loads (> 72VA)	10A	—	7A	5A	3A	1A
		DC	DC-12 Control of resistive loads & solid state loads	10A	5A	—	2.2A	1.1A	—
			DC-13 Control of electromagnets	5A	2A	—	1.1A	0.6A	—

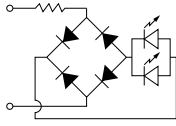
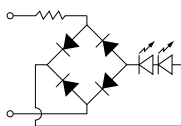
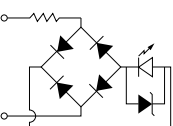
 For dimensions, see page 683.
Note 1. Except HW2B

LED Lamp Ratings (LSTD Type)

Model		LSTD-6Ⓞ	LSTD-1Ⓞ	LSTD-2Ⓞ	LSTD-H2Ⓞ	LSTD-M4Ⓞ
Lamp Base		BA9S/13				
Rated Voltage		6V AC/DC	12V AC/DC	24V AC/DC	120V AC	240V AC
Voltage Range		6V AC/DC ±10%	12V AC/DC ±10%	24V AC/DC ±10%	120V AC ±5%	240V AC ±5%
Current Draw	AC	A, R, W: G, S: 17mA 8mA	11mA	11mA	10mA	10mA
	DC	A, R, W: G, S: 14mA 5.5mA	10mA	10mA	—	—
Color Code		A (amber), G (green), R (red), S (blue), W (white)				
Lamp Base Color		Same as illumination color				
Voltage Marking		Die stamped on the base				
Life (reference value)		Approx. 50,000 hours (The luminance reduces to 50% the initial intensity when used on complete DC.)				
Internal Circuit	A, R, W		A, R, W			
						
	G, S					
		 LED Chip  Protection Diode  Zener Diode				

 In place of Ⓞ, specify the Lens/LED Color Code.

Non-Illuminated Round Pushbuttons (Assembled)



Function	Contacts	Round Flush		Round Extended	
		Plastic Bezel	Metal Bezel	Plastic Bezel	Metal Bezel
Momentary	Operator Only	HW1B-M1-①	HW4B-M1-①	HW1B-M2-①	HW4B-M2-①
	1NO	HW1B-M1F10-①	HW4B-M1F10-①	HW1B-M2F10-①	HW4B-M2F10-①
	1NC	HW1B-M1F01-①	HW4B-M1F01-①	HW1B-M2F01-①	HW4B-M2F01-①
	1NO-1NC	HW1B-M1F11-①	HW4B-M1F11-①	HW1B-M2F11-①	HW4B-M2F11-①
	2NO	HW1B-M1F20-①	HW4B-M1F20-①	HW1B-M2F20-①	HW4B-M2F20-①
	2NC	HW1B-M1F02-①	HW4B-M1F02-①	HW1B-M2F02-①	HW4B-M2F02-①
	2NO-2NC	HW1B-M1F22-①	HW4B-M1F22-①	HW1B-M2F22-①	HW4B-M2F22-①
Maintained	Operator Only	HW1B-A1-①	HW4B-A1-①	HW1B-A2-①	HW4B-A2-①
	1NO	HW1B-A1F10-①	HW4B-A1F10-①	HW1B-A2F10-①	HW4B-A2F10-①
	1NC	HW1B-A1F01-①	HW4B-A1F01-①	HW1B-A2F01-①	HW4B-A2F01-①
	1NO-1NC	HW1B-A1F11-①	HW4B-A1F11-①	HW1B-A2F11-①	HW4B-A2F11-①
	2NO	HW1B-A1F20-①	HW4B-A1F20-①	HW1B-A2F20-①	HW4B-A2F20-①
	2NC	HW1B-A1F02-①	HW4B-A1F02-①	HW1B-A2F02-①	HW4B-A2F02-①
	2NO-2NC	HW1B-A1F22-①	HW4B-A1F22-①	HW1B-A2F22-①	HW4B-A2F22-①

① Button Color Code

Color	Code
Black	B
Green	G
Red	R
Blue	S
White	W
Yellow	Y



1. In place of ①, specify the Button Color Code from table below.
2. For nameplates and accessories, see page 678 and 681.
3. For dimensions, see page 683.
4. For contact assembly part numbers, see page 683.
5. All assembled part numbers in catalog include standard, Finger-Safe (HW-U...) contacts.
6. Operator only models include operator plus button.
7. Additional contact configurations available (up to 6 total contacts).

Part Number Structure

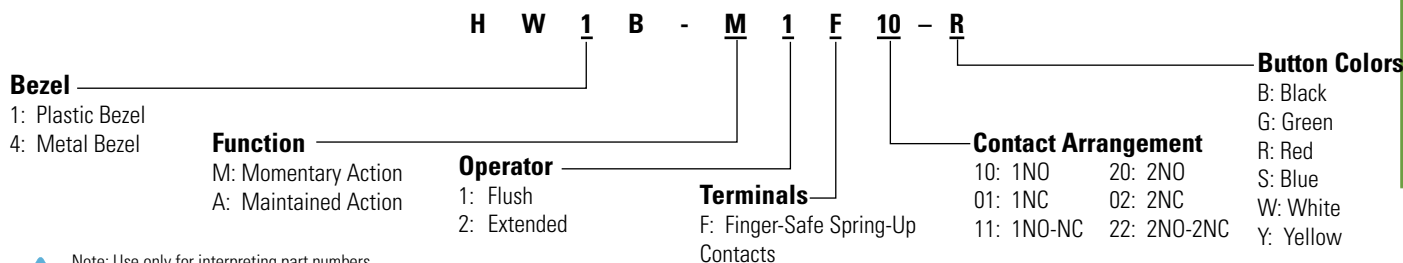

Note: Use only for interpreting part numbers.
Do not use for developing part numbers.

Non-Illuminated Round Pushbuttons (Replacement Parts)

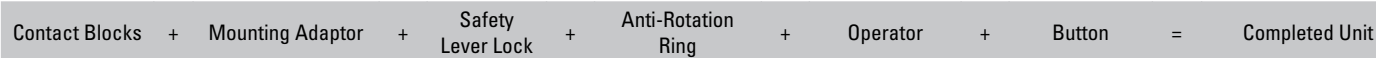

Contact Blocks

Style	Contacts	1NO	1NC
	Finger-Safe Spring-Up Terminal	HW-U10-F	HW-U01-F
		HW-U10R-F (early make)	HW-U01R-F (late break)
	Dummy Block	HW-DB	

Anti-Rotation Ring

Style	Part Number
	HW9Z-RL

Use with notched panel cutout to prevent unit rotation.

Buttons

Style	Part Number
Round Flush 	HW1A-B1-①
Round Extended 	HW1A-B2-①

1. In place of ①, specify the Button Color Code from table.

① Button Color Code

Color	Code
Black	B
Green	G
Red	R
Blue	S
White	W
Yellow	Y

Contact Block Mounting Adaptor

Style	Part Number
	HW-CB2C

- Used to mount contact blocks to operator.
- IEEC strongly recommends using the safety lever lock to prevent heavy vibration or maintenance personnel from inadvertently unlocking contacts.

Operators

Style		Plastic Bezel	Metal Bezel
Round Flush/ Extended 	Momentary	HW1B-M0	HW4B-M0
	Maintained 	HW1B-A0	HW4B-A0

Safety Lever Lock

Style	Part Number
	HW9Z-LS

Non-Illuminated Mushroom Head Pushbuttons (Assembled)



		ø29mm Mushroom Head		ø40mm Mushroom Head	
Function	Contacts	Plastic Bezel	Metal Bezel	Plastic Bezel	Metal Bezel
Momentary	Operator Only	HW1B-M3-⓪	HW4B-M3-⓪	HW1B-M4-⓪	HW4B-M4-⓪
	1NO	HW1B-M3F10-⓪	HW4B-M3F10-⓪	HW1B-M4F10-⓪	HW4B-M4F10-⓪
	1NC	HW1B-M3F01-⓪	HW4B-M3F01-⓪	HW1B-M4F01-⓪	HW4B-M4F01-⓪
	1NO-1NC	HW1B-M3F11-⓪	HW4B-M3F11-⓪	HW1B-M4F11-⓪	HW4B-M4F11-⓪
	2NO	HW1B-M3F20-⓪	HW4B-M3F20-⓪	HW1B-M4F20-⓪	HW4B-M4F20-⓪
	2NC	HW1B-M3F02-⓪	HW4B-M3F02-⓪	HW1B-M4F02-⓪	HW4B-M4F02-⓪
	2NO-2NC	HW1B-M3F22-⓪	HW4B-M3F22-⓪	HW1B-M4F22-⓪	HW4B-M4F22-⓪
Maintained	Operator Only	HW1B-A3-⓪	HW4B-A3-⓪	HW1B-A4-⓪	HW4B-A4-⓪
	1NO	HW1B-A3F10-⓪	HW4B-A3F10-⓪	HW1B-A4F10-⓪	HW4B-A4F10-⓪
	1NC	HW1B-A3F01-⓪	HW4B-A3F01-⓪	HW1B-A4F01-⓪	HW4B-A4F01-⓪
	1NO-1NC	HW1B-A3F11-⓪	HW4B-A3F11-⓪	HW1B-A4F11-⓪	HW4B-A4F11-⓪
	2NO	HW1B-A3F20-⓪	HW4B-A3F20-⓪	HW1B-A4F20-⓪	HW4B-A4F20-⓪
	2NC	HW1B-A3F02-⓪	HW4B-A3F02-⓪	HW1B-A4F02-⓪	HW4B-A4F02-⓪
	2NO-2NC	HW1B-A3F22-⓪	HW4B-A3F22-⓪	HW1B-A4F22-⓪	HW4B-A4F22-⓪



		ø60mm Mushroom Head	
Function	Contacts	Plastic Bezel	
Momentary	Operator Only	HW1B-M5-⓪*	
	1NO	HW1B-M5F10-⓪*	
	1NC	HW1B-M5F01-⓪*	
	1NO-1NC	HW1B-M5F11-⓪*	
	2NO	HW1B-M5F20-⓪*	
	2NC	HW1B-M5F02-⓪*	
	2NO-2NC	HW1B-M5F22-⓪*	

⓪ Button Color Code

Color	Code
Black	B
Green	G
Red	R
Blue	S
White	W
Yellow	Y



1. In place of ⓪, specify the Button Color Code from table.
2. *60mm mushroom available only in red, green, black, and yellow.
3. For nameplates and accessories, see page 678 and 681.
4. For dimensions, see page 683.
5. For contact assembly part numbers, see page 683.
6. All assembled part numbers in catalog include standard spring-up Finger-Safe (HW-U...) contacts.
7. Operator only models include operator plus button.
8. Additional contact configurations available (up to 6 total contacts).

Switches & Pilot Devices

Signaling Lights

Relays & Sockets

Timers

Contactors

Terminal Blocks

Circuit Breakers

Part Number Structure

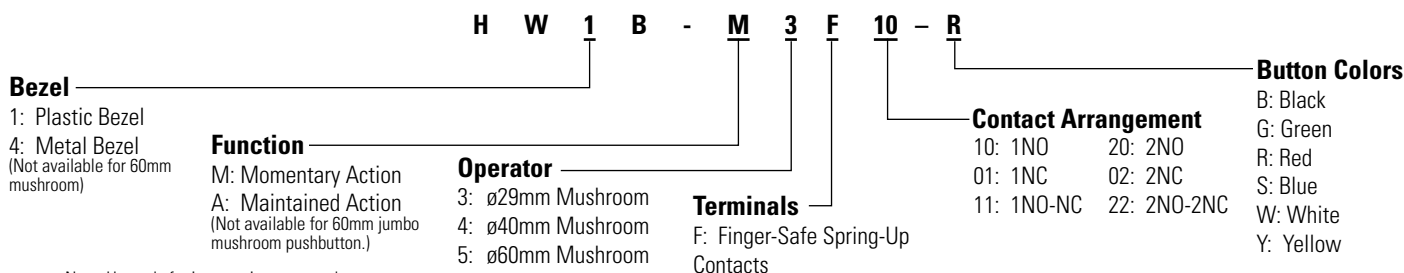

Note: Use only for interpreting part numbers. Do not use for developing part numbers.

Non-Illuminated Mushroom Head Pushbuttons (Replacement Parts)

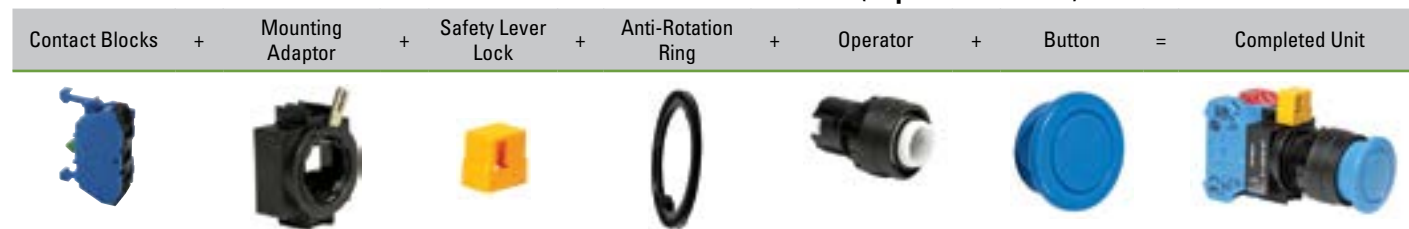

Contact Blocks

Style	Contacts	1NO	1NC
	Finger-Safe Spring-Up Terminal	HW-U10-F	HW-U01-F
		HW-U10R-F (early make)	HW-U01R-F (late break)
	Dummy Block	HW-DB	

Contact Block Mounting Adaptor

Style	Part Number
	HW-CB2C

- Used to mount contact blocks to operator.
- IDEC strongly recommends using the safety lever lock to prevent heavy vibration or maintenance personnel from inadvertently unlocking contacts.

Safety Lever Lock

Style	Part Number
	HW9Z-LS

Anti-Rotation Ring

Appearance	Part Number
	HW9Z-RL

Operators

Style	Plastic Bezel	Metal Bezel	
ø29mm Mushroom ø40mm Mushroom	Momentary	HW1B-MOL	HW4B-MOL
	Maintained	HW1B-AOL	HW4B-AOL
ø60mm Jumbo Mushroom	Momentary	HW1B-M5-⊙*	-

- *60mm mushroom operator includes non-removable button (available in red, black, green and yellow).
- For nameplates and accessories, see page 678 and 681.
- For dimensions, see page 683.

Buttons

Style	Part Number
ø29mm Mushroom Cap	HW1A-B3-⊙
ø40mm Mushroom Cap	HW1A-B4-⊙

- In place of ⊙, specify the Button Color Code from table.

⊙ Button Color Code

Color	Code	Color	Code
Black	B	Blue	S
Green	G	White	W
Red	R	Yellow	Y

- HW1B-M5 available only in black, red, green and yellow.

Non-Illuminated Square Pushbuttons (Assembled)



Function	Contacts	Square Flush	Square Extended
		Plastic Bezel	Plastic Bezel
Momentary	<i>Operator Only</i>	HW2B-M1-①	HW2B-M2-①
	1NO	HW2B-M1F10-①	HW2B-M2F10-①
	1NC	HW2B-M1F01-①	HW2B-M2F01-①
	1NO-1NC	HW2B-M1F11-①	HW2B-M2F11-①
	2NO	HW2B-M1F20-①	HW2B-M2F20-①
	2NC	HW2B-M1F02-①	HW2B-M2F02-①
	2NO-2NC	HW2B-M1F22-①	HW2B-M2F22-①
Maintained	<i>Operator Only</i>	HW2B-A1-①	HW2B-A2-①
	1NO	HW2B-A1F10-①	HW2B-A2F10-①
	1NC	HW2B-A1F01-①	HW2B-A2F01-①
	1NO-1NC	HW2B-A1F11-①	HW2B-A2F11-①
	2NO	HW2B-A1F20-①	HW2B-A2F20-①
	2NC	HW2B-A1F02-①	HW2B-A2F02-①
	2NO-2NC	HW2B-A1F22-①	HW2B-A2F22-①

① Button Color Code

Color	Code
Black	B
Green	G
Red	R
Blue	S
White	W
Yellow	Y



1. In place of ①, specify the Button Color Code from table.
2. For nameplates and accessories, see page 678 and 681.
3. For dimensions, see page 683.
4. For contact assembly part numbers, see page 683.
5. Square pushbuttons available in plastic bezel only.
6. All assembled part numbers in catalog include finger-safe spring-up (HW-U...) contacts.
7. Operator only model includes operator and button.
8. Additional contact configurations available (up to 6 total contacts).

Part Number Structure

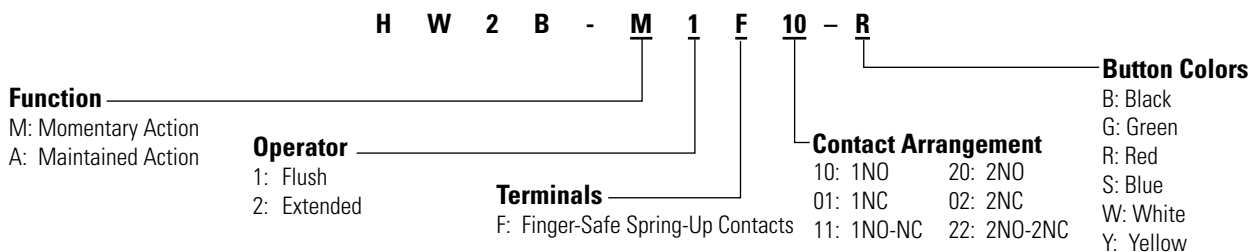

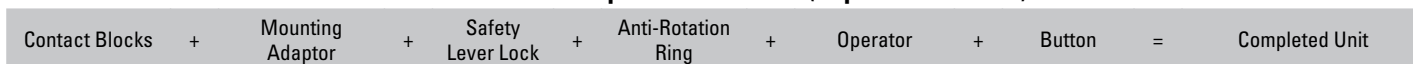

 Note: Use only for interpreting part numbers. Do not use for developing part numbers.

Non-Illuminated Square Pushbuttons (Replacement Parts)



Contact Blocks

Style	Contacts	1NO	1NC
	Finger-Safe Spring-Up Terminal	HW-U10-F	HW-U01-F
		HW-U10R-F (early make)	HW-U01R-F (late break)
	Dummy Block	HW-DB	

Contact Block Mounting Adaptor

Style	Part Number
	HW-CB2C

-  1. Used to mount contact blocks to operator.
2. IDEC strongly recommends using the safety lever lock to prevent heavy vibration or maintenance personnel from inadvertently unlocking contacts.

Safety Lever Lock

Style	Part Number
	HW9Z-LS

Anti-Rotation Ring

Appearance	Part Number
	HW9Z-RL

-  Use with notched panel cutout to prevent unit rotation.

Operators

Style	Plastic Bezel
	Momentary HW2B-M0
	Maintained HW2B-A0

-  2. For nameplates and accessories, see pages 678 and 681.
3. For dimensions, see page 683.

Buttons

Style	Part Number
Square Flush 	HW2A-B1-⓪
Square Extended 	HW2A-B2-⓪

-  1. In place of ⓪, specify the Button Color Code from table.

⓪ Button Color Code

Color	Code	Color	Code
Black	B	Blue	S
Green	G	White	W
Red	R	Yellow	Y

Non-Illuminated E-Stop Pushbuttons (Assembled)



Contacts	Ø29mm Head Pushlock Turn Reset		Ø40mm Head Pushlock Turn Reset	
	Plastic Bezel	Metal Bezel	Plastic Bezel	Metal Bezel
<i>Operator Only</i>	HW1B-V3Ⓞ†	HW4B-V3Ⓞ†	HW1B-V4Ⓞ†	HW4B-V4Ⓞ†
1NO	HW1B-V3F10-Ⓞ†	HW4B-V3F10-Ⓞ†	HW1B-V4F10-Ⓞ†	HW4B-V4F10-Ⓞ†
1NC	HW1B-V3F01-Ⓞ†	HW4B-V3F01-Ⓞ†	HW1B-V4F01-Ⓞ†	HW4B-V4F01-Ⓞ†
1NO-1NC	HW1B-V3F11-Ⓞ†	HW4B-V3F11-Ⓞ†	HW1B-V4F11-Ⓞ†	HW4B-V4F11-Ⓞ†
2NO	HW1B-V3F20-Ⓞ†	HW4B-V3F20-Ⓞ†	HW1B-V4F20-Ⓞ†	HW4B-V4F20-Ⓞ†
2NC	HW1B-V3F02-Ⓞ†	HW4B-V3F02-Ⓞ†	HW1B-V4F02-Ⓞ†	HW4B-V4F02-Ⓞ†



Contacts	Ø40mm Head EMO Pushlock Turn Reset		Ø40mm Head Pushlock Key Reset	
	Plastic Bezel	Metal Bezel	Plastic Bezel	Metal Bezel
<i>Operator Only</i>	HW1B-V4R-EMO-2*	HW4B-V4R-EMO-2*	HW1B-X4R*	HW4B-X4R*
1NO	HW1B-V4F10-R-EMO-2*	HW4B-V4F10-R-EMO-2*	HW1B-X4F10-R*	HW4B-X4F10-R*
1NC	HW1B-V4F01-R-EMO-2*	HW4B-V4F01-R-EMO-2*	HW1B-X4F01-R*	HW4B-X4F01-R*
1NO-1NC	HW1B-V4F11-R-EMO-2*	HW4B-V4F11-R-EMO-2*	HW1B-X4F11-R*	HW4B-X4F11-R*
2NO	HW1B-V4F20-R-EMO-2*	HW4B-V4F20-R-EMO-2*	HW1B-X4F20-R*	HW4B-X4F20-R*
2NC	HW1B-V4F02-R-EMO-2*	HW4B-V4F02-R-EMO-2*	HW1B-X4F02-R*	HW4B-X4F02-R*



- * Available in Red only.
- † Available in red or yellow. Insert color code in place of Ⓞ (R: Red, Y: Yellow).
- For accessories, see page 681.
- For dimensions, see page 683.
- For nameplates and shrouds, see page 683.
- For contact assembly part numbers, see page 683.
- All HW series E-stops comply with EN60947-5-5, the IEC "E-Stop Addendum to the Low Voltage Directive," this includes "tamper proof" operation whereby a change of contact state is not possible by "teasing" or "floating" the operator.
- All assembled part numbers in catalog include standard finger-safe spring-up (HW-U...) contacts.
- Operator only models include operator and button.
- Additional contact configurations available (up to 6 total contacts).

Contacts	ø60mm Head Pushlock Turn Reset
	Plastic Bezel
<i>Operator Only</i>	HW1B-V5R*
1NO	HW1B-V5F10-R*
1NC	HW1B-V5F01-R*
1NO-1NC	HW1B-V5F11-R*
2NO	HW1B-V5F20-R*
2NC	HW1B-V5F02-R*

Part Number Structure

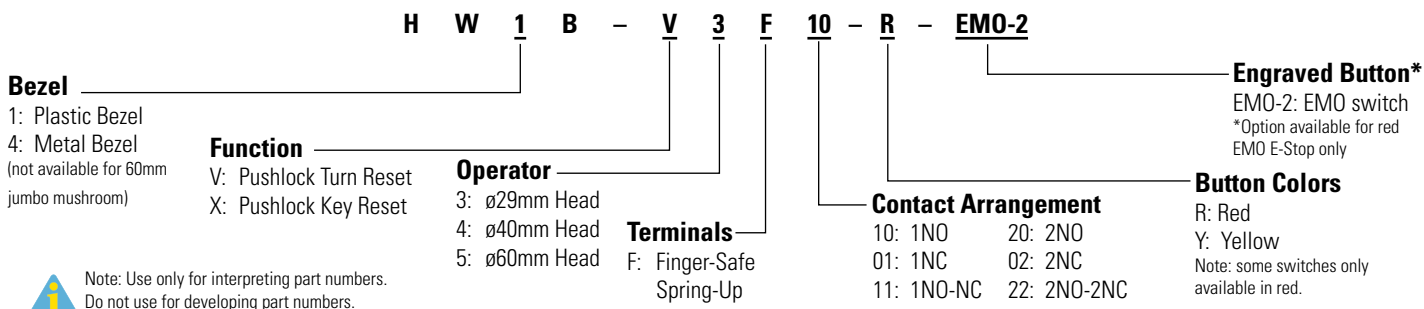

Non-Illuminated E-Stop Pushbuttons (Replacement Parts)

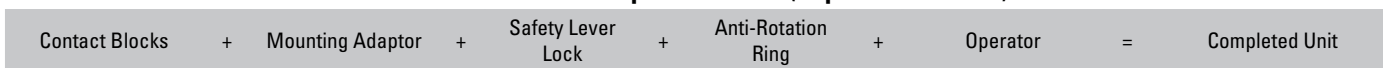

Contact Blocks

Style	Contacts	1NO	1NC
	Finger-Safe Spring-Up Terminal	HW-U10-F	HW-U01-F
		HW-U10R-F (early make)	HW-U01R-F (late break)
	Dummy Block	HW-DB	

Safety Lever Lock

Style	Part Number
	HW9Z-LS

Anti-Rotation Ring

Appearance	Part Number
	HW9Z-RL

Note: Use with notched panel cutout to prevent unit rotation.

Contact Block Mounting Adaptor

Style	Part Number
	HW-CB2C

- Used to mount contact blocks to operator.
- IEDEC strongly recommends using the safety lever lock to prevent heavy vibration or maintenance personnel from inadvertently unlocking contacts.

Operators

Style	Plastic	Metal
ø29mm Head Pushlock Turn Reset 	red	HW1B-V3R HW4B-V3R
	yellow	HW1B-V3Y HW4B-V3Y
ø40mm Head Pushlock Turn Reset 	red	HW1B-V4R HW4B-V4R
	yellow	HW1B-V4Y HW4B-V4Y
ø40mm Head EMO Pushlock Turn Reset* 		HW1B-V4R-EMO-2 HW4B-V4R-EMO-2
ø40mm Head Pushlock Key Reset* 		HW1B-X4R HW4B-X4R
ø60mm Head Pushlock Turn Reset* 		HW1B-V5R -

- * Available in red only.
- All E-Stop buttons are not removable from the operator.

Note: Determine mounting centers to ensure proper spacing.

Push Pull & Unibody E-Stop Pushbuttons (Assembled)



Switches & Pilot Devices

Signaling Lights

Relays & Sockets

Timers

Contactors

Terminal Blocks

Circuit Breakers

Contacts	ø40mm Head Push-Pull	
	Plastic Bezel	Metal Bezel
Operator Only (Red)	HW1B-Y2R	HW4B-Y2R
Operator Only (Yellow)	HW1B-Y2Y	HW4B-Y2Y
1NO	HW1B-Y2F10-⓪†	HW4B-Y2F10-⓪†
1NC	HW1B-Y2F01-⓪†	HW4B-Y2F01-⓪†
1NO-1NC	HW1B-Y2F11-⓪†	HW4B-Y2F11-⓪†
2NC	HW1B-Y2F02-⓪†	HW4B-Y2F02-⓪†
2NO	HW1B-Y2F20-⓪†	HW4B-Y2F20-⓪†

Contacts	ø40mm Unibody Pushlock Turn Reset*	
	Plastic Bezel	
1NO-1NC	HW1E-BV4F11-R	
2NC	HW1E-BV4F02-R	
1NO-2NC*	HW1E-BV412R-TK2093-1	



* NO contact is used as a monitoring contact

Contacts	Unibody Illuminated E-Stops*	
	LED	
1NO-1NC	HW1E-LV4F11QD-R-⓪	
2NC	HW1E-LV4F02QD-R-⓪	
2NC (with push-on illumination)	HW1E-TV4F02QD-R-⓪	
1NO-1NC (with push-on illumination)	HW1E-TV4F11QD-R-⓪	



- * Available in Red only.
- † Available in red or yellow. Insert color code in place of ⓪ (R: Red, Y: Yellow).
- In place of ⓪, specify Full Voltage LED Code.
- With single unit construction, the positive action contacts are integrated in the body of the switch. This provides an extra degree of safety and reliability for critical emergency stop functions.
- In the illuminated version, the light is independent of the switch action (except push-on LED model).
- For accessories, see page 681.
- For dimensions, see page 683.
- For nameplates and shrouds, see page 681.
- For contact assembly part numbers, see page 681.
- All HW Series E-Stop operators include non-removable color caps.
- All HW series E-Stops comply with EN60947-5-5, the IEC "E-Stop Addendum to the Low Voltage Directive," this includes "tamper proof" operation whereby a change of contact state is not possible by "teasing" or "floating" the operator.
- All HW series E-Stop switches comply with SEMI S2 standards.
- All assembled part numbers in catalog include standard finger-safe spring-up (HW-U...) contacts.
- Additional contact configurations available (up to 6 total contacts).

⓪ Full Voltage LED Code

Voltage	Code
6VAC/DC	6V
12VAC/DC	12V
24VAC/DC	24V
120V AC	120V
240V AC	240V

Terminal Numbering (Unibody only)

Models	Terminal Number
1NO-1NC	NO = 13/14, NC = 11/12
2NC	NC = 11/12, NC = 21/22
HW1E-L HW1E-T	LED + = X2, LED - = X1

Part Number Structure

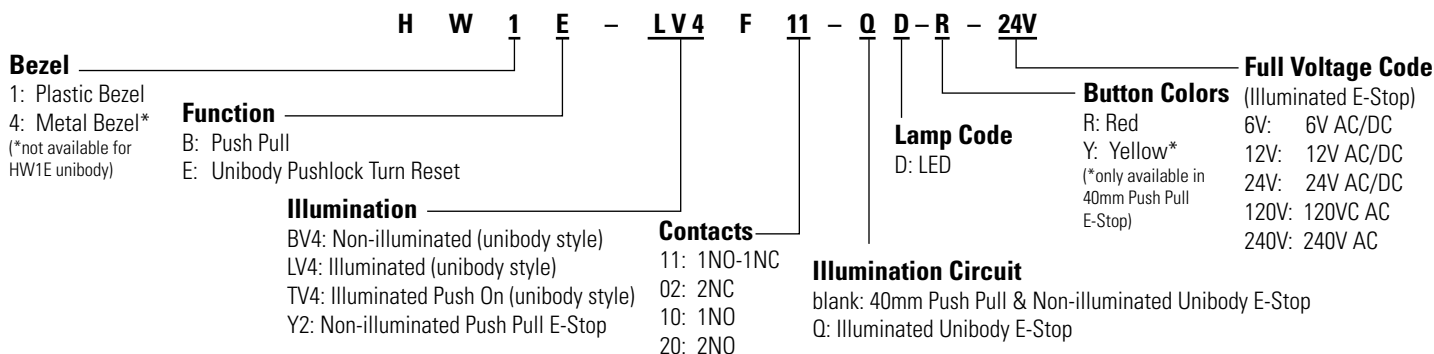

Note: Use only for interpreting part numbers. Do not use for developing part numbers.

Illuminated & Non-Illuminated E-Stop Pushbuttons (Replacement Parts)

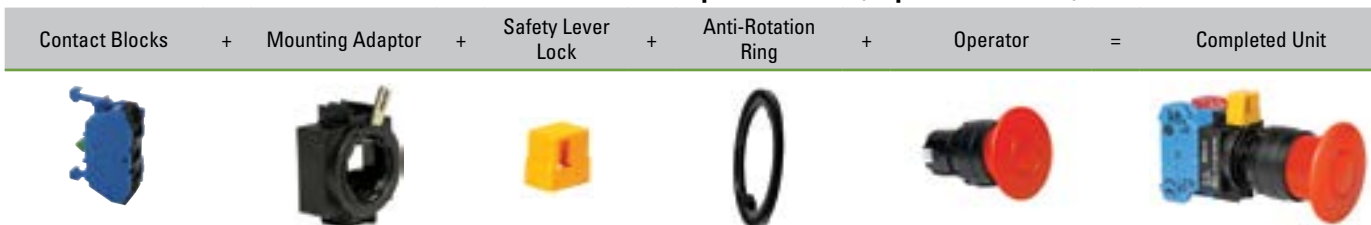

Contact Blocks

Style	Contacts	1NO	1NC
	Finger-Safe Spring-Up Terminal	HW-U10-F	HW-U01-F
		HW-U10R-F (early make)	HW-U01R-F (late break)
	Dummy Block	HW-DB	

- There are no replacement parts for the HW1E unibody E-Stop.
- For illuminated unibody E-Stop, see page 683 for replacement lens.

Contact Block Mounting Adaptor

Style	Part Number
	HW-CB2C

- Used to mount contact blocks to operator.
- IEDEC strongly recommends using the safety lever lock to prevent heavy vibration or maintenance personnel from inadvertently unlocking contacts.

Safety Lever Lock

Style	Part Number
	HW9Z-LS

Anti-Rotation Ring

Appearance	Part Number
	HW9Z-RL

Use with notched panel cutout to prevent unit rotation.

Operators

Style		Part Number	
ø40mm Head Push-Pull	Plastic	red	HW1B-Y2R
		red	HW4B-Y2R
	Metal	yellow	HW1B-Y2Y
		yellow	HW4B-Y2Y

All E-Stop Buttons are not removable from the operator.

E-Stop Stations



	29mm Pushlock Turn Reset		40mm Pushlock Turn Reset	
Contacts	Plastic Bezel	Metal Bezel	Plastic Bezel	Metal Bezel
1NO-1NC	FB1W-HW1B-V311R	FB1W-HW4B-V311R	FB1W-HW1B-V411R	FB1W-HW4B-V411R
2NC	FB1W-HW1B-V302R	FB1W-HW4B-V302R	FB1W-HW1B-V402R	FB1W-HW4B-V402R



	40mm Push-Pull Reset		40mm Pushlock Key Reset	
Contacts	Plastic Bezel	Metal Bezel	Plastic Bezel	Metal Bezel
1NO-1NC	FB1W-HW1B-Y211R	FB1W-HW4B-Y211R	FB1W-HW1B-X411R	FB1W-HW4B-X411R
2NC	FB1W-HW1B-Y202R	FB1W-HW4B-Y202R	FB1W-HW1B-X402R	FB1W-HW4B-X402R



	40mm EMO Pushlock Turn Reset	
Contacts	Plastic Bezel	Metal Bezel
1NO-1NC	FB1W-HW1B-V411R-EMO-2	FB1W-HW4B-V411R-EMO-2
2NC	FB1W-HW1B-V402R-EMO-2	FB1W-HW4B-V402R-EMO-2

- 1. Maximum of two contact blocks.
- 2. Box is supplied with yellow top and black bottom only.

Jumbo Dome Pilot Lights



Plastic Bezel

Actual Size



Jumbo Dome	LED	Operator Only	HW1P-500
		Full Voltage 24V AC/DC	HW1P-504-Ⓢ

- 1. In place of Ⓢ, specify the Lens/LED Color Code.
- 2. Spring-Up terminals with 24V LED.
- 3. For nameplates and accessories, see page 678 and 681.
- 4. For dimensions, see page 683.

Ⓢ Lens/LED Color Code

Color	Code
Amber	A
Green	G
Red	R
Blue	S
White	W
Yellow	Y



Jumbo Dome Replacement Parts

Item	Appearance	Description	Part Number
Lens		Polycarbonate Lens	HW1A-P5Ⓢ
LED Diffusing Lens			HW9Z-PP5C
LED Lamps		LED Lamp	LSTDB-2Ⓢ

- 1. In place of Ⓢ, specify the Lens/LED Color Code.
- 2. Use white LED for yellow lens.

Lamp Ratings

	Part Number	Operating Voltage	Rated Current	Power Consumption
LED	LSTDB-2	24V AC/DC ±10%	15mA	0.36W



Pilot Lights (Assembled)



		Round Flush		Dome	
		Plastic Bezel	Metal Bezel	Plastic Bezel	Metal Bezel
Operator Only		HW1P-1FQ0-②	HW4P-1FQ0-②	HW1P-2FQ0-②	HW4P-2FQ0-②
Full Voltage		HW1P-1FQD-②-③	HW4P-1FQD-②-③	HW1P-2FQD-②-③	HW4P-2FQD-②-③
Transformer	120V AC	HW1P-1FH2D-②	HW4P-1FH2D-②	HW1P-2FH2D-②	HW4P-2FH2D-②
	240V AC	HW1P-1FM4D-②	HW4P-1FM4D-②	HW1P-2FM4D-②	HW4P-2FM4D-②
	480V AC	HW1P-1FT8D-②	HW4P-1FT8D-②	HW1P-2FT8D-②	HW4P-2FT8D-②
DC-DC Converter*	110V DC	HW1P-1D2D-②	—	HW1P-2D2D-②	—



		Square Flush
		Plastic Bezel
Operator Only		HW2P-1FQ0-②
Full Voltage		HW2P-1FQD-②-③
Transformer	120V AC	HW2P-1FH2D-②
	240V AC	HW2P-1FM4D-②
	480V AC	HW2P-1FT8D-②
DC-DC Converter*	110V DC	HW2P-1D2D-②

 * DC-DC converter voltage input from 90-140V DC.

② Lens/LED Color Code

Color	Code
Amber	A
Green	G
Red	R
Blue	S
White	W
Yellow	Y

③ LED Full Voltage Code

Voltage	Code
6VAC/DC	6V
12VAC/DC	12V
24VAC/DC	24V
120V AC	120V
240V AC	240V



1. In place of ②, specify the Lens/LED Color Code from table below.
2. In place of ③ specify the Full Voltage Code from table below.
3. For nameplates and accessories, see page 678 and 681.
4. For dimensions, see page 683.
5. **Pilot lights do not come with anti-rotation ring.**
6. Operator models come with operator and lens.
7. **Yellow pilot light comes with white LED.**

Part Number Structure

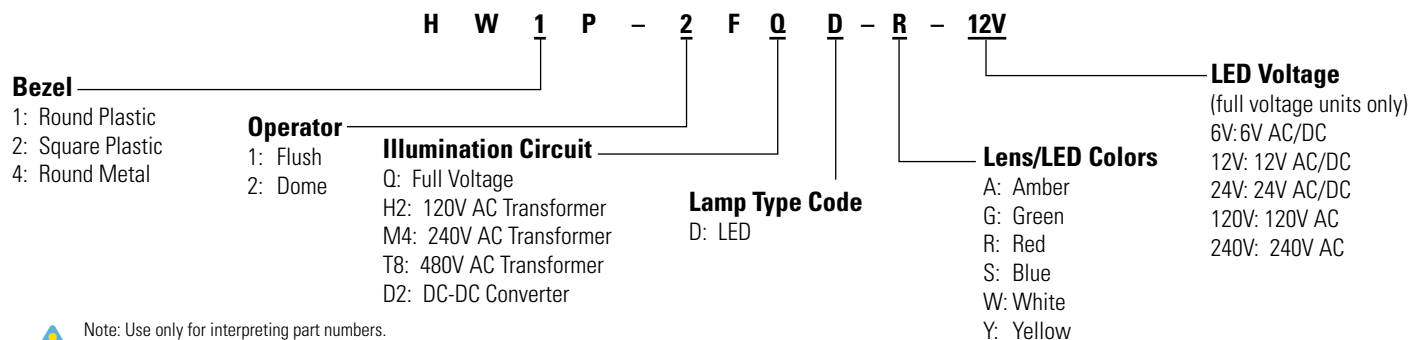

Note: Use only for interpreting part numbers. Do not use for developing part numbers.

Pilot Lights (Replacement Parts)

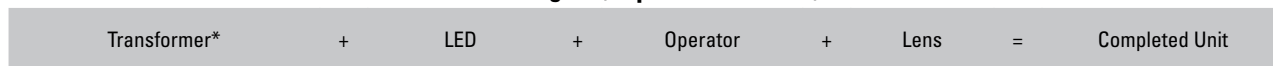

(not applicable for full voltage units)

Transformer Units

Style	Voltage	Part Number
	120V AC	HW-FH20
	240V AC	HW-FM40
	480V AC	HW-FT80
(6V secondary voltage)	110V DC†	HW-RD0*

1. *DC-DC converter can only be used with HW1P-100 and HW2P-100 operators
2. † DC-DC converter voltage input from 90-140V DC.

LED Lamps

Style	Voltage	Part Number
	6V AC/DC	LSTD-6Ⓞ
	12V AC/DC	LSTD-1Ⓞ
	24V AC/DC	LSTD-2Ⓞ
	120V AC	LSTD-H2Ⓞ
	240V AC	LSTD-M4Ⓞ

1. In place of Ⓞ, specify the LED Color Code.
2. The LED contains a current-limiting resistor and reverse polarity protection diodes.

② LED Color Code

Color	Code	Color	Code
Amber	A	Blue	S
Green	G	White	W
Red	R		

For yellow lens use white LED.

Operators

Style	Type	Plastic Bezel	Metal Bezel
Round Flush 	Full Voltage	Finger-Safe	HW1P-1FQ0
	Transformer	Finger-Safe	HW1P-10
		Used for DC-DC converter only	HW1P-100
Dome 	Full Voltage	Finger-Safe	HW1P-2FQ0
	Transformer	Finger-Safe	HW1P-20
		Used for DC-DC converter only	HW1P-200
Square Flush 	Full Voltage	Finger-Safe	HW2P-1FQ0
	Transformer	Finger-Safe	HW2P-10
		Used for DC-DC converter only	HW2P-100

1. Transformer type requires separate transformer & LED. Must select correct transformer bases. Use 6V LEDs.
2. Full voltage type only requires LED.

Lenses

Style	Part Number
Round/Flush 	HW1A-P1-Ⓞ
Dome 	HW1A-P2-Ⓞ
Square/Flush 	HW2A-P1-Ⓞ

In place of Ⓞ, specify the Lens Color Code.

③ Lens Color Code

Color	Code
Amber	A
Green	G
Red	R
Blue	S
White	W
Yellow	Y

For yellow lens use white LED.

Illuminated Round Pushbuttons (Assembled)



Illuminated Full Voltage Pushbuttons



Contacts	Flush		Extended		Extended w/ Full Shroud	
	Plastic Bezel	Metal Bezel	Plastic Bezel	Metal Bezel	Plastic Bezel	Metal Bezel
Momentary Operator Only 1NO 1NC 1NO-1NC 2NO	HW1L-M1-②	HW4L-M1-②	HW1L-M2-②	HW4L-M2-②	HW1L-MF2-②	HW4L-MF2-②
	HW1L-M1F10QD-②-③	HW4L-M1F10QD-②-③	HW1L-M2F10QD-②-③	HW4L-M2F10QD-②-③	HW1L-MF2F10QD-②-③	HW4L-MF2F10QD-②-③
	HW1L-M1F01QD-②-③	HW4L-M1F01QD-②-③	HW1L-M2F01QD-②-③	HW4L-M2F01QD-②-③	HW1L-MF2F01QD-②-③	HW4L-MF2F01QD-②-③
	HW1L-M1F11QD-②-③	HW4L-M1F11QD-②-③	HW1L-M2F11QD-②-③	HW4L-M2F11QD-②-③	HW1L-MF2F11QD-②-③	HW4L-MF2F11QD-②-③
	HW1L-M1F20QD-②-③	HW4L-M1F20QD-②-③	HW1L-M2F20QD-②-③	HW4L-M2F20QD-②-③	HW1L-MF2F20QD-②-③	HW4L-MF2F20QD-②-③
Maintained Operator Only 1NO 1NC 1NO-1NC 2NO	HW1L-A1-②	HW4L-A1-②	HW1L-A2-②	HW4L-A2-②	HW1L-AF2-②	HW4L-AF2-②
	HW1L-A1F10QD-②-③	HW4L-A1F10QD-②-③	HW1L-A2F10QD-②-③	HW4L-A2F10QD-②-③	HW1L-AF2F10QD-②-③	HW4L-AF2F10QD-②-③
	HW1L-A1F01QD-②-③	HW4L-A1F01QD-②-③	HW1L-A2F01QD-②-③	HW4L-A2F01QD-②-③	HW1L-AF2F01QD-②-③	HW4L-AF2F01QD-②-③
	HW1L-A1F11QD-②-③	HW4L-A1F11QD-②-③	HW1L-A2F11QD-②-③	HW4L-A2F11QD-②-③	HW1L-AF2F11QD-②-③	HW4L-AF2F11QD-②-③
	HW1L-A1F20QD-②-③	HW4L-A1F20QD-②-③	HW1L-A2F20QD-②-③	HW4L-A2F20QD-②-③	HW1L-AF2F20QD-②-③	HW4L-AF2F20QD-②-③

Illuminated Transformer Pushbuttons



Contacts	Flush		Extended		Extended w/ Full Shroud	
	Plastic Bezel	Metal Bezel	Plastic Bezel	Metal Bezel	Plastic Bezel	Metal Bezel
Momentary Operator Only 1NO-1NC 2NO	HW1L-M1-②	HW4L-M1-②	HW1L-M2-②	HW4L-M2-②	HW1L-MF2-②	HW4L-MF2-②
	HW1L-M1F11-③D-②	HW4L-M1F11-③D-②	HW1L-M2F11-③D-②	HW4L-M2F11-③D-②	HW1L-MF2F11-③D-②	HW4L-MF2F11-③D-②
	HW1L-M1F20-③D-②	HW4L-M1F20-③D-②	HW1L-M2F20-③D-②	HW4L-M2F20-③D-②	HW1L-MF2F20-③D-②	HW4L-MF2F20-③D-②
Maintained Operator Only 1NO-1NC 2NO	HW1L-A1-②	HW4L-A1-②	HW1L-A2-②	HW4L-A2-②	HW1L-AF2-②	HW4L-AF2-②
	HW1L-A1F11-③D-②	HW4L-A1F11-③D-②	HW1L-A2F11-③D-②	HW4L-A2F11-③D-②	HW1L-AF2F11-③D-②	HW4L-AF2F11-③D-②
	HW1L-A1F20-③D-②	HW4L-A1F20-③D-②	HW1L-A2F20-③D-②	HW4L-A2F20-③D-②	HW1L-AF2F20-③D-②	HW4L-AF2F20-③D-②

- In place of ②, specify Lens/LED Color Code from table.
- In place of ③ specify Voltage Code from table.
- Light independent of switch position.
- For replacement part numbers, see page 649.
- For nameplates and accessories, see page 678 and 681.
- For dimensions, see page 683.
- For contact assembly part numbers, see page 683.
- Full voltage and transformer models use the same operator.
- Additional contact configurations available (up to 6 total contacts).
- 10. Yellow pushbutton comes with white LED.**

② Lens/LED Color Code

Color	Code
Amber	A
Green	G
Red	R
Blue	S
White	W
Yellow	Y



Yellow LED not available. Use white LED for yellow lens.

③ Voltage Code

Full Voltage Models		Transformer Models	
Voltage	Code	Voltage	Code
6V AC/DC	6V	120V AC	H2
12V AC/DC	12V	240V AC	M4
24V AC/DC	24V	480V AC	T8
120V AC	120V		
240V AC	240V		

Part Number Structure

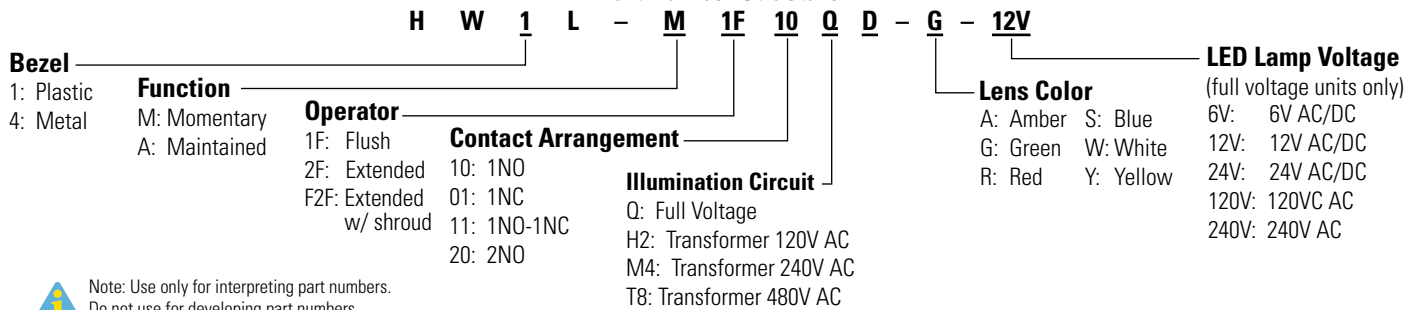

Illuminated Round Pushbuttons (Replacement Parts)

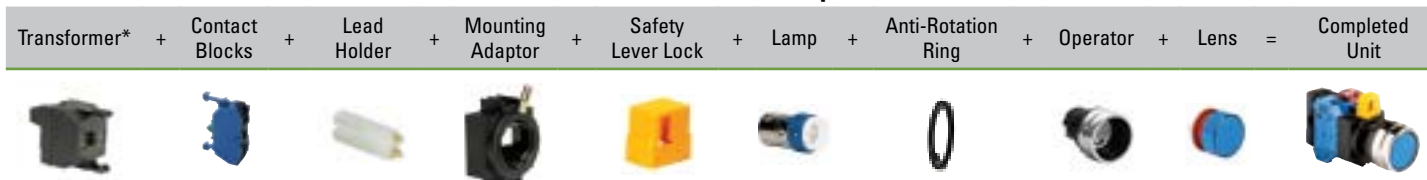

Note: *Transformer not needed with full voltage models.

Lamp Circuit Components

Style	Description	Terminals	Part Number
	For use with HW-CBL on all illuminated pushbutton units. One required for each deck (pair) of contacts.		HW-LH3
	For use with odd number of contacts.	Finger-Safe	HW-DA1FBN
	For use with even number of contacts.	Finger-Safe	TW-DA1FB
	120VAC 240VAC 480VAC	Finger-Safe	TW-F126B TW-F246B TW-F486B
	110VDC		HW-L16D

- *With spring-up terminals - to use spring-up terminal type, must use transformer type operator designed for spring-up transformer.
- ** DC-DC converter voltage input from 90-140V DC.

Operators

Style		Plastic Bezel	Metal Bezel
Round Flush/Extended		HW1L-M0	HW4L-M0
		HW1L-A0	HW4L-A0
Extended with Full Shroud		HW1L-MF0	HW4L-MF0
		HW1L-AF0	HW4L-AF0

Contact Blocks

Style	Contacts	1NO	1NC
	Finger-Safe Spring-Up Terminal	HW-U10-F HW-U10R-F (early make)	HW-U01-F HW-U01R-F (late break)

- All assembled part numbers in catalog include standard finger-safe spring-up (HW-U...) contacts.

Contact Block Mounting Adaptor

Style	Part Number
	HW-CBL

- Used to mount contact blocks to operator (first pair only).
- IEDEC strongly recommends using the safety lever lock to prevent heavy vibration or maintenance personnel from inadvertently unlocking contacts.

Safety Lever Lock

Style	Part Number
	HW9Z-LS

Lenses

Style	Part Number
Round Flush	
Round Extended	

- In place of ⊙, specify the Lens Color Code from previous page.

Anti-Rotation Ring

Appearance	Part Number
	HW9Z-RL

- Use with notched panel cutout to prevent unit rotation.

LED Lamps

Style	Voltage	Part Number
	6V AC/DC	LSTD-6⊙
	12V AC/DC	LSTD-1⊙
	24V AC/DC	LSTD-2⊙
	120V AC	LSTD-H2⊙
	240V AC	LSTD-M4⊙

- In place of ⊙, specify the LED Color Code.
- The LED contains a current-limiting resistor and reverse polarity protection diodes.
- Yellow LED not available, use white LED when using yellow lens.

Illuminated Mushroom & Square Pushbuttons (Assembled)



		40mm Mushroom Head		Square Flush	
		Contacts	Plastic Bezel	Metal Bezel	
Full Voltage	Momentary	<i>Operator Only</i> [†]	HW1L-M4-②	HW4L-M4-②	HW2L-M1-②
		1NO	HW1L-M4F10QD-②-③	HW4L-M4F10QD-②-③	HW2L-M1F10QD-②-③
		1NC	HW1L-M4F01QD-②-③	HW4L-M4F01QD-②-③	HW2L-M1F01QD-②-③
		1NO-1NC	HW1L-M4F11QD-②-③	HW4L-M4F11QD-②-③	HW2L-M1F11QD-②-③
		2NO	HW1L-M4F20QD-②-③	HW4L-M4F20QD-②-③	HW2L-M1F20QD-②-③
	Maintained	<i>Operator Only</i> [†]	HW1L-A4-②	HW4L-A4-②	HW2L-A1-②
		1NO	HW1L-A4F10QD-②-③	HW4L-A4F10QD-②-③	HW2L-A1F10QD-②-③
		1NC	HW1L-A4F01QD-②-③	HW4L-A4F01QD-②-③	HW2L-A1F01QD-②-③
		1NO-1NC	HW1L-A4F11QD-②-③	HW4L-A4F11QD-②-③	HW2L-A1F11QD-②-③
		2NO	HW1L-A4F20QD-②-③	HW4L-A4F20QD-②-③	HW2L-A1F20QD-②-③
Transformer	Momentary	1NO-1NC	HW1L-M4F11③D-②	HW4L-M4F11③D-②	HW2L-M1F11③D-②
		2NO	HW1L-M4F20③D-②	HW4L-M4F20③D-②	HW2L-M1F20③D-②
	Maintained	1NO-1NC	HW1L-A4F11③D-②	HW4L-A4F11③D-②	HW2L-A1F11③D-②
		2NO	HW1L-A4F20③D-②	HW4L-A4F20③D-②	HW2L-A1F20③D-②



- [†] Full voltage and transformer units use the same operator.
- In place of ②, specify the Lens/LED Color Code from table.
- In place of ③ specify the Voltage Code from table.
- Light independent of switch position
- For nameplates and accessories, see page 678. and 681.
- For dimensions, see page 683.
- For contact assembly part numbers, see page 683.
- Additional contact configurations available (up to 6 total contacts).
- 9. Yellow pushbutton comes with white LED.**

② Lens/LED Color Code

Color	Code
Amber	A
Green	G
Red	R
Blue	S
White	W
Yellow	Y*



- *40mm mushroom lenses not available in yellow.
- Yellow LED not available. Use white LED for yellow lens.

③ Voltage Code

Full Voltage Models		Transformer Models	
Voltage	Code	Voltage	Code
6V AC/DC	6V	120V AC	H2
12V AC/DC	12V	240V AC	M4
24V AC/DC	24V	480V AC	T8
120V AC	120V		
240V AC	240V		

Part Number Structure

H W 1 L - M 1 F 10 Q D - G - 12V

Bezel
 1: Round Plastic
 2: Square Plastic
 4: Round Metal

Function
 M: Momentary
 A: Maintained

Operator
 1: Square Flush
 4: Mushroom

Contact Arrangement
 10: 1NO
 01: 1NC
 11: 1NO-1NC
 20: 2NO

Illumination Circuit
 Q: Full Voltage
 H2: Transformer 120V AC
 M4: Transformer 240V AC
 T8: Transformer 480V AC

Lens Color
 A: Amber S: Blue
 G: Green W: White
 R: Red Y: Yellow

Voltage
 (full voltage units only)
 6V: 6V AC/DC
 12V: 12V AC/DC
 24V: 24V AC/DC
 120V: 120V AC
 240V: 240V AC

Note: Use only for interpreting part numbers. Do not use for developing part numbers.

Illuminated Mushroom & Square Pushbuttons (Replacement Parts)

Transformer*	+	Contact Blocks	+	Lead Holder	+	Adaptor†	+	Safety Lever Lock	+	LED	+	Anti-Rotation Ring	+	Operator	+	Lens	=	Completed Unit
--------------	---	----------------	---	-------------	---	----------	---	-------------------	---	-----	---	--------------------	---	----------	---	------	---	----------------

*Transformer not needed with full voltage models.

Lamp Circuit Components

Style	Description	Terminals	Part Number
Lead Holder	For use with HW-CBL on all illuminated pushbutton units. One required for each deck (pair) of contacts.		HW-LH3
Dummy Block with Full Voltage Adaptor	For use with odd number of contacts.	Finger-Safe	HW-DA1FBN
Full Voltage Adaptor	For use with even number of contacts.	Finger-Safe	TW-DA1FB
Transformer Unit (6V secondary voltage)	120VAC 240VAC 480VAC	Finger-Safe	TW-F126B TW-F246B TW-F486B
DC-DC Converter	110VDC		HW-L16D

- *With spring-up terminals - to use spring-up terminal type, must use transformer type operator designed for spring-up transformer.
- ** DC-DC converter voltage input from 90-140V DC.

Operators

Style	Plastic Bezel	Metal Bezel
ø40mm Mushroom	Momentary	HW1L-M0L HW4L-M0L
	Maintained	HW1L-A0L HW4L-A0L
Square	Momentary	HW2L-M0
	Maintained	HW2L-A0

Contact Blocks

Style	Contacts	1NO	1NC
Finger-Safe Spring-Up Terminal		HW-U10-F HW-U10R-F (early make)	HW-U01-F HW-U01R-F (late break)

- All assembled part numbers in catalog include standard finger-safe spring-up contacts (HW-U...).

Contact Block Mounting Adaptor

Style	Part Number
	HW-CBL

- Used to mount contact blocks to operator (first pair only).
- IDEC strongly recommends using the safety lever lock to prevent heavy vibration or maintenance personnel from inadvertently unlocking contacts.

Anti-Rotation Ring

Appearance	Part Number
	HW9Z-RL

- Use with notched panel cutout to prevent unit rotation.

Safety Lever Lock

Style	Part Number
	HW9Z-LS

Lenses

Style	Part Number
ø40mm Mushroom Lens	ALW4BLU-⊙*
Square Flush	HW2A-L1-⊙

- In place of ⊙, specify the Lens Color Code.
- *Mushroom lens not available in yellow.

LED Lamps

Style	Voltage	Part Number
LED	6V AC/DC	LSTD-6⊙
	12V AC/DC	LSTD-1⊙
	24V AC/DC	LSTD-2⊙
	120V AC	LSTD-H2⊙
	240V AC	LSTD-M4⊙

- In place of ⊙, specify the LED Color Code.
- The LED contains a current-limiting resistor and reverse polarity protection diodes.
- Yellow LED not available, use white LED when using yellow lens.

Selector Switches 2-Position (Assembled)



2-Position Selector Switches

Contact	Mounting	Operator Position		Handle	Maintained	Spring Return from Right
		L	R			
<i>Operator Only</i>				<i>Knob Lever</i>	<i>HWⓈS-2T HWⓈS-2L</i>	<i>HWⓈS-21T HWⓈS-21L</i>
1NO	1	0	X	Knob Lever	HWⓈS-2TF10 HWⓈS-2LF10	HWⓈS-21TF10 HWⓈS-21LF10
1NO- 1NC	1 2	0 X	X 0	Knob Lever	HWⓈS-2TF11 HWⓈS-2LF11	HWⓈS-21TF11 HWⓈS-21LF11
2NO	1 2	0 0	X X	Knob Lever	HWⓈS-2TF20 HWⓈS-2LF20	HWⓈS-21TF20 HWⓈS-21LF20
2NO- 2NC	1 2 3 4	X 0 X 0	0 X 0 X	Knob Lever	HWⓈS-2TF22 HWⓈS-2LF22	HWⓈS-21TF22 HWⓈS-21LF22



1. In place of Ⓢ enter 1 for plastic bezel or 4 for metal bezel.
2. For nameplates, see page 678.
3. All assembled part numbers in catalog include standard finger-safe spring-up (HW-U...) contacts.
4. Standard color for knob and lever is black.
5. Optional colors available for lever type. Must order in components. See next page for part numbers.
6. Additional contact configurations available (up to 6 total contacts).
7. For Truth Tables see page 691.

Ⓢ Bezel Type

Type	Code
Plastic	1
Metal	4

Part Number Structure

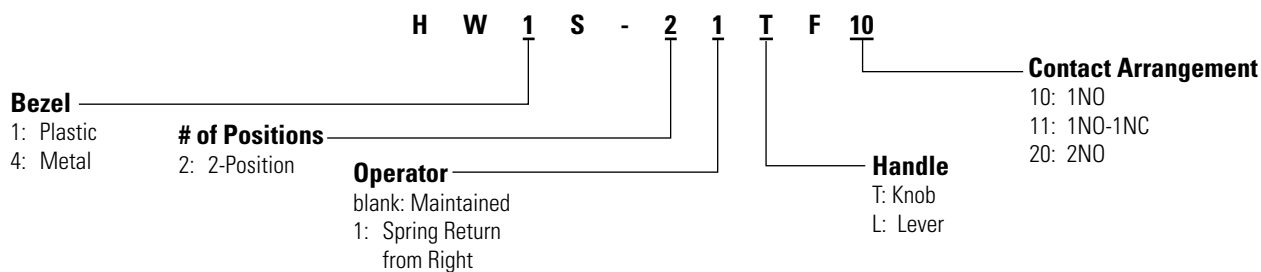

Note: Use only for interpreting part numbers. Do not use for developing part numbers.

Selector Switches 2-Position (Replacement Parts)



Contact Blocks

Style	Contacts	1NO	1NC
	Finger-Safe	HW-U10-F	HW-U01-F
	Spring-Up Terminal	HW-U10R-F (early make)	HW-U01R-F (late break)
	Dummy Block	HW-DB	

Anti-Rotation Ring

Style	Part Number
	HW9Z-RL

Use with notched panel cutout to prevent unit rotation.

Contact Block Mounting Adaptor

Style	Part Number
	HW-CB2C

- Used to mount contact blocks to operator (first pair only).
- IEDEC strongly recommends using the safety lever lock to prevent heavy vibration or maintenance personnel from inadvertently unlocking contacts.

Operators

Style	Description	Handle	Plastic Bezel	Metal Bezel
	Maintained	Knob	HW1S-2T	HW4S-2T
		Lever	HW1S-2	HW4S-2
	Spring Return from Right	Knob	HW1S-21T	HW4S-21T
		Lever	HW1S-21	HW4S-21

- Knob operator comes with black handle.
- To order lever type, lever and inserts must be ordered separately, along with lever operator. See part numbers below.

Safety Lever Lock

Style	Part Number
	HW9Z-LS

Levers & Inserts

Style	Part Number
	ASWHHL-①
	TW-HC1-①

Standard lever color is black. Standard insert color is white.

① Handle/Insert Color Code

Color	Code
Black*	B
Blue	S
Green	G
Red	R
Yellow	Y
White†	W

- * Lever color inserts not available in black.
- † Lever not available in white.

Selector Switches 3-Position (Assembled)



3-Position Selector Switches

Contact	Mounting	Operator Position			Handle	Maintained	Spring Return from Right	Spring Return from Left	Spring Return Two-Way
		L	C	R					
Operator Only					Knob Lever	HW⊙S-3T* HW⊙S-3L	HW⊙S-31T HW⊙S-31L	HW⊙S-32T HW⊙S-32L	HW⊙S-33T HW⊙S-33L
1NO-1NC	1	0	X	X	Knob Lever	HW⊙S-3TF11 HW⊙S-3LF11	HW⊙S-31TF11 HW⊙S-31LF11	HW⊙S-32TF11 HW⊙S-32LF11	HW⊙S-33TF11 HW⊙S-33LF11
	2	0	0	X					
2NO	1	X	0	0	Knob Lever	HW⊙S-3TF20 HW⊙S-3LF20	HW⊙S-31TF20 HW⊙S-31LF20	HW⊙S-32TF20 HW⊙S-32LF20	HW⊙S-33TF20 HW⊙S-33LF20
	2	0	0	X					
2NC	1	0	X	X	Knob Lever	HW⊙S-3TF02 HW⊙S-3LF02	HW⊙S-31TF02 HW⊙S-31LF02	HW⊙S-32TF02 HW⊙S-32LF02	HW⊙S-33TF02 HW⊙S-33LF02
	2	X	X	0					
2NO-1NC	1	X	0	0	Knob	HW⊙S-3JTF21N1	-	-	-
	2	0	0	X					
	3	0	X	0					
2NO-2NC	1	X	0	0	Knob	HW⊙S-3TF22	HW⊙S-31TF22	HW⊙S-32TF22	HW⊙S-33TF22
	2	0	0	X					
	3	0	X	X					
	4	X	X	0					
2NO-2NC	1	0	0	X	Knob	HW⊙S-3STF22N9	-	-	-
	2	X	0	0					
	3	X	X	0					
	4	0	0	X					
4NO	1	X	0	0	Knob	HW⊙S-3TF40	HW⊙S-31TF40	HW⊙S-32TF40	HW⊙S-33TF40
	2	0	0	X					
	3	X	0	0					
	4	0	0	X					
4NO	1	X	0	0	Knob	HW⊙S-3STF40N2	-	-	-
	2	0	X	X					
	3	X	0	0					
	4	0	0	X					
4NC	1	0	X	X	Knob	HW⊙S-3TF04	HW⊙S-31TF04	HW⊙S-32TF04	HW⊙S-33TF04
	2	X	X	0					
	3	0	X	X					
	4	X	X	0					

Ⓢ Bezel Type

Type	Code
Plastic	1
Metal	4

- In place of ⊙ enter 1 for plastic bezel or 4 for metal bezel.
- Knob operator includes black knob/lever operator includes black lever.
- * Three position operator is available with three different cams.
HW⊙S-3T: Maintained (standard cam)
HW⊙S-3ST: Maintained (S cam)
HW⊙S-3JT: Maintained (J cam)
- Operator cams are color coded (white=standard cam, red=S cam, black =J cam).
- For nameplates, see page 678.
- For contact assembly part numbers, see page 683
- All assembled part numbers in catalog include standard finger-safe spring-up (HW-U...) contacts.
- Standard color for knob and lever is black.
- Optional colors available for lever type. Must order in components. See next page for part numbers.
- Additional contact configurations available (up to 6 total contacts).
- For Truth Tables see page 691.

Part Number Structure

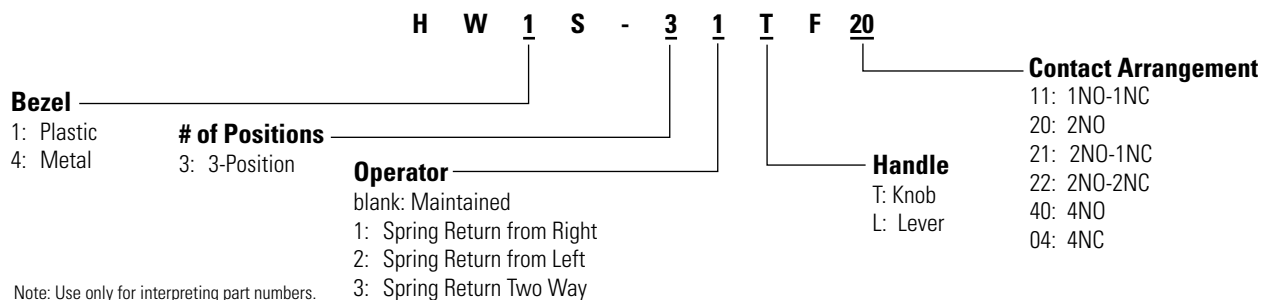

Selector Switches 3-Position (Replacement Parts)



Contact Blocks

Style	Contacts	1NO	1NC
	Finger-Safe Spring-Up Terminal	HW-U10-F	HW-U01-F
		HW-U10R-F (early make)	HW-U01R-F (late break)
	Dummy Block	HW-DB	

Anti-Rotation Ring

Style	Part Number
	HW9Z-RL

Use with notched panel cutout to prevent unit rotation.

Operators

Style	Description	Handle	Plastic Bezel	Metal Bezel
	Maintained (standard cam)	Knob	HW1S-3T	HW4S-3T
		Lever	HW1S-3	HW4S-3
	Maintained (S cam)	Knob	HW1S-3ST	HW4S-3ST
		Knob	HW1S-3JT	HW4S-3JT
	Maintained (J cam)	Knob	HW1S-31T	HW4S-31T
		Lever	HW1S-31	HW4S-31
	Spring Return from Right (standard cam)	Knob	HW1S-32T	HW4S-32T
		Lever	HW1S-32	HW4S-32
	Spring Return from Left (standard cam)	Knob	HW1S-33T	HW4S-33T
		Lever	HW1S-33	HW4S-33

Contact Block Mounting Adaptor

Style	Part Number
	HW-CB2C

- 1. Used to mount contact blocks to operator (first pair only).
- 2. IDEC strongly recommends using the safety lever lock to prevent heavy vibration or maintenance personnel from inadvertently unlocking contacts.

- 1. Knob operator comes with black handle.
- 2. Three position knob operator is available with three different cams.
- 3. Operator cams are color coded (white=standard cam, red=S cam, black=J cam).
- 4. To order lever type, lever and inserts must be ordered separately, along with lever operator. See part numbers below.

Safety Lever Lock

Style	Part Number
	HW9Z-LS

Levers & Inserts

Style	Part Number
	ASWHHL-⓪
	TW-HC1-⓪

① Handle/Insert Color Code

Color	Code
Black*	B
Blue	S
Green	G
Red	R
Yellow	Y
White [†]	W

- 1. * Lever color inserts not available in black.
- 2. [†]Lever not available in white.

Standard lever color is black. Standard insert color is white.

Selector Switches 4- & 5-Position (Assembled)



4-Position Selector Switches

Contact	Mounting	Operator Position				Handle	Maintained
		1	2	3	4		
<i>Operator Only</i>						Knob Lever	HWⓈS-4T HWⓈS-4L
1NO- 2NC	1	X	0	0	0	Knob Lever	HWⓈS-4TF12 HWⓈS-4LF12
	2	0	X	0	0		
	3	0	0	X	0		
	4	0	0	0	0		
1NO- 3NC	1	0	X	X	X	Knob Lever	HWⓈS-4TF13N6 HWⓈS-4LF13N6
	2	0	X	0	0		
	3	0	0	X	0		
	4	0	0	0	X		
2NO- 2NC	1	X	0	0	0	Knob Lever	HWⓈS-4TF22N3 HWⓈS-4LF22N3
	2	0	X	0	0		
	3	0	0	X	0		
	4	0	0	0	X		

5-Position Selector Switch

Contact	Mounting	Operator Position					Handle	Maintained
		1	2	3	4	5		
<i>Operator Only</i>						Knob Lever	HWⓈS-5T HWⓈS-5L	
2NO- 2NC	1	X	0	0	0	0	Knob Lever	HWⓈS-5TF22N3 HWⓈS-5LF22N3
	2	0	X	0	0	0		
	3	0	0	0	X	0		
	4	0	0	0	0	X		



1. In place of Ⓢ enter 1 for plastic bezel or 4 for metal bezel.
2. Knob operator includes black knob/lever operator includes black lever.
3. For nameplates, see page 678.
4. For contact assembly part numbers, see page 683.
5. Five position circuit cannot be made to make five independent contact closures.
6. All assembled part numbers in catalog include standard finger-safe spring-up (HW-U...) contacts.
7. Standard color for knob and lever is black.
8. Optional colors available for lever type. Must order in components. See next page for part numbers.
9. Additional contact configurations available (up to 6 total contacts).
10. For Truth Tables see page 691.

Ⓢ Bezel Type

Type	Code
Plastic	1
Metal	4

Part Number Structure

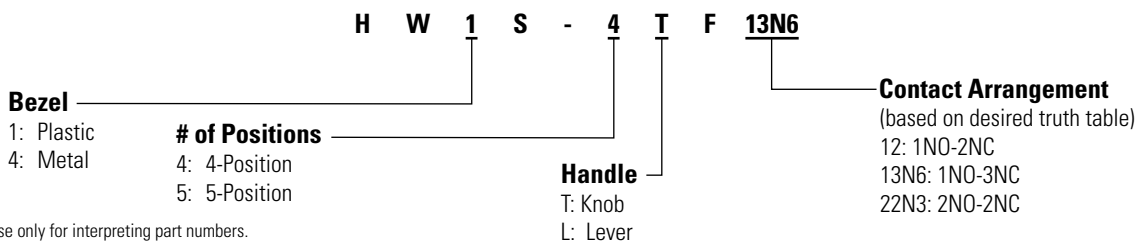

Note: Use only for interpreting part numbers. Do not use for developing part numbers.

Selector Switches 4- & 5-Position (Replacement Parts)



Contact Blocks

Style	Contacts	1NO	1NC
	Finger-Safe Spring-Up Terminal	HW-U10-F	HW-U01-F
		HW-U10R-F (early make)	HW-U01R-F (late break)
	Dummy Block	HW-DB	

Anti-Rotation Ring

Style	Part Number
	HW9Z-RL

Use with notched panel cutout to prevent unit rotation.

Operators

Style	Position	Description	Handle	Plastic Bezel	Metal Bezel
	4	Maintained	Knob	HW1S-4T	HW4S-4T
			Lever	HW1S-4	HW4S-4
	5	Maintained	Knob	HW1S-5T	HW4S-5T
			Lever	HW1S-5	HW4S-5

1. Knob operator comes with black handle.
2. To order lever type, lever and inserts must be ordered separately, along with lever operator. See part numbers below.

Contact Block Mounting Adaptor

Style	Part Number
	HW-CB2C

1. Used to mount contact blocks to operator (first pair only).
2. IDEC strongly recommends using the safety lever lock to prevent heavy vibration or maintenance personnel from inadvertently unlocking contacts.

Safety Lever Lock

Style	Part Number
	HW9Z-LS

Levers & Inserts

Style	Part Number
	Lever ASWHHL-⓪
	Lever Color Insert TW-HC1-⓪

Standard lever color is black. Standard insert color is white.

① Handle/Insert Color Code



Color	Code
Black*	B
Blue	S
Green	G
Red	R
Yellow	Y
White†	W

1. * Lever color inserts not available in black.
2. †Lever not available in white.

Key Switches 2-Position (Assembled)



2-Position Key Switches

Contact	Mounting	Operator Position		Maintained	Spring Return from Right
		L	R	L 	L 
<i>Operator Only</i>				HW⊙K-2A	HW⊙K-21B
1NO	1	0	X	HW⊙K-2AF10	HW⊙K-21BF10
1NO-1NC	1	0	X	HW⊙K-2AF11	HW⊙K-21BF11
	2	X	0		
2NO	1	0	X	HW⊙K-2AF20	HW⊙K-21BF20
	2	0	X		
2NO-2NC	1	0	X	HW⊙K-2AF22	HW⊙K-21BF22
	2	X	0		
	3	0	X		
	4	X	0		

- 1. In place of ⊙ enter 1 for plastic bezel or 4 for metal bezel.
- 2. Key is removable in all maintained positions. Other key removable options available.
- 3. Two keys are supplied with all switches.
- 4. All standard operators are keyed alike.
- 5. Other key removable options available. See table below
- 6. For nameplates, see page 678.
- 7. For contact assembly part numbers, see page 683.
- 8. Key is retained in "Spring Return" position.
- 9. All assembled part numbers in catalog include finger-safe spring-up (HW-U...) contacts.
- 10. Additional contact configurations available (up to 6 total contacts).
- 11. For Truth Tables see page 683.

⊙ Bezel Type

Type	Code
Plastic	1
Metal	4

Key Removable Option Codes

Code	Description
A	Key not retained in any position (removable in all positions)
B	Key retained in right position only (removable LEFT)
C	Key retained in left position only (removable RIGHT)

Part Number Structure

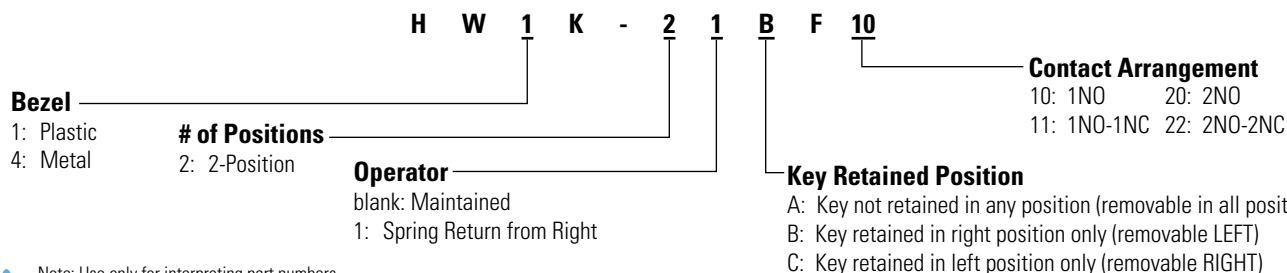

Note: Use only for interpreting part numbers. Do not use for developing part numbers.

Key Switches 2-Position (Replacement Parts)

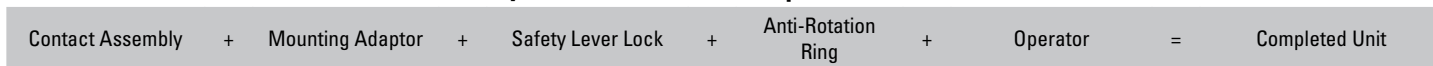

Contact Blocks

Style	Contacts	1NO	1NC
	Finger-Safe	HW-U10-F	HW-U01-F
	Spring-Up Terminal	HW-U10R-F (early make)	HW-U01R-F (late break)
	Dummy Block	HW-DB	

Safety Lever Lock

Style	Part Number
	HW9Z-LS

Anti-Rotation Ring

Style	Part Number
	HW9Z-RL

Use with notched panel cutout to prevent unit rotation.

Contact Block Mounting Adaptor

Style	Part Number
	HW-CB2C

1. Used to mount contact blocks to operator (first pair only).
2. IDEC strongly recommends using the safety lever lock to prevent heavy vibration or maintenance personnel from inadvertently unlocking contacts.

Operators

Style	Description	Plastic Bezel	Metal Bezel
	Maintained	HW1K-2A	HW4K-2A
	Maintained, key removed left only	HW1K-2B	HW4K-2B
	Spring Return from Right	HW1K-21B	HW4K-21B
	Maintained, key removed right only	HW1K-2C	HW4K-2C

1. Operator includes two keys.
2. All standard operators are keyed alike.

Key Switches 3-Position (Assembled)



3-Position Key Switches

Contact	Mounting	Operator Position			Maintained	Spring Return from Right	Spring Return from Left	Spring Return Two Way
		L	C	R				
<i>Operator Only</i>					HW⊙K-3A*	HW⊙K-31B	HW⊙K-32C	HW⊙K-33D
1NO-1NC	1	0	X	X	HW⊙K-3AF11	HW⊙K-31BF11	HW⊙K-32CF11	HW⊙K-33DF11
	2	0	0	X				
2NO	1	X	0	0	HW⊙K-3AF20	HW⊙K-31BF20	HW⊙K-32CF20	HW⊙K-33DF20
	2	0	0	X				
2NC	1	0	X	X	HW⊙K-3AF02	HW⊙K-31BF02	HW⊙K-32CF02	HW⊙K-33DF02
	2	X	X	0				
2NO-1NC	1	X	0	0	HW⊙K-3JAF21N1	-	-	-
	2	0	0	X				
	3	0	X	0				
2NO-2NC	1	X	0	0	HW⊙K-3AF22	HW⊙K-31BF22	HW⊙K-32CF22	HW⊙K-33DF22
	2	0	0	X				
	3	0	X	X				
	4	X	X	0				
2NO-2NC	1	0	0	X	HW⊙K-3SAF22N9	-	-	-
	2	X	0	0				
	3	X	X	0				
	4	0	0	X				
4NO	1	X	0	0	HW⊙K-3AF40	HW⊙K-31BF40	HW⊙K-32CF40	HW⊙K-33DF40
	2	0	0	X				
	3	X	0	0				
	4	0	0	X				
4NO	1	X	0	0	HW⊙K-3SAF40N2	-	-	-
	2	0	X	X				
	3	X	0	0				
	4	0	0	X				
4NC	1	0	X	X	HW⊙K-3AF04	HW⊙K-31BF04	HW⊙K-32CF04	HW⊙K-33DF04
	2	X	X	0				
	3	0	X	X				
	4	X	X	0				

Ⓢ Bezel Type

Type	Code
Plastic	1
Metal	4

- In place of ⊙ enter 1 for plastic bezel or 4 for metal bezel.
- Key is removable in all maintained positions. Other key removable options available.
- Two keys are supplied with all switches.
- All standard operators are keyed alike.
- Other key removable options available. See table to the right.
- * Operator is available with three different cams.
HW⊙K-3A: Maintained (standard cam)
HW⊙K-3SA: Maintained (Cam S)
HW⊙K-3JA: Maintained (Cam J)
- For nameplates, see page 678.

- For contact assembly part numbers, see page 683.
- All assembled part numbers in catalog include standard Finger-Safe spring-up (HW-U...) contacts.
- Additional contact configurations available (up to 6 total contacts).
- For Truth Tables see page 691.

Key Removable Option Codes

Code	Description
A	Key not retained in any position (removable in all positions)
B	Key retained in right position only
C	Key retained in left position only
D	Key retained in left and right (3 position only)
E	Key retained in center only (3 position only)
G	Key retained right and center (3 position only)
H	Key retained left and center (3 position only)

Part Number Structure

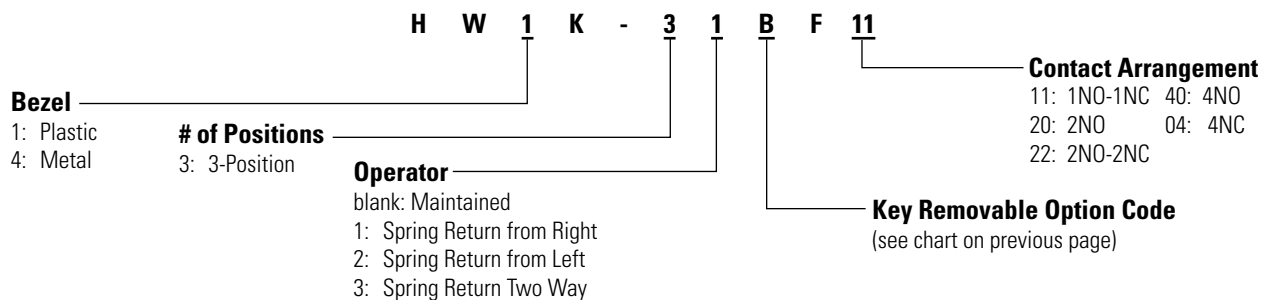

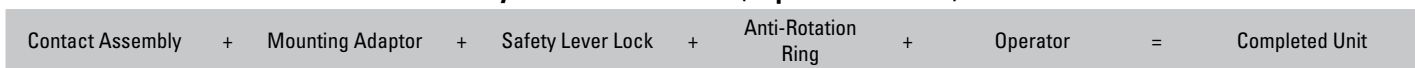

 Note: Use only for interpreting part numbers. Do not use for developing part numbers.

Key Switches 3-Position (Replacement Parts)



Contact Blocks

Style	Contacts	1NO	1NC
	Finger-Safe Spring-Up Terminal	HW-U10-F	HW-U01-F
		HW-U10R-F (early make)	HW-U01R-F (late break)
	Dummy Block	HW-DB	

Safety Lever Lock

Style	Part Number
	HW9Z-LS

Anti-Rotation Ring

Style	Part Number
	HW9Z-RL

 Use with notched panel cutout to prevent unit rotation.

Contact Block Mounting Adaptor

Style	Part Number
	HW-CB2C

-  1. Used to mount contact blocks to operator (first pair only).
2. IDEC strongly recommends using the safety lever lock to prevent heavy vibration or maintenance personnel from inadvertently unlocking contacts.

Operators



Style	Description	Plastic Bezel	Metal Bezel
	Maintained (standard cam)	HW1K-3A	HW4K-3A
	Maintained (S cam)	HW1K-3SA	HW4K-3SA
	Maintained (J cam)	HW1K-3JA	HW4K-3JA
	Spring Return from Right (standard cam)	HW1K-31B	HW4K-31B
	Spring Return from Left (standard cam)	HW1K-32C	HW4K-32C
	2-Way Spring Return (standard cam)	HW1K-33D	HW4K-33D

-  1. Operator includes two keys.
2. All standard operators are keyed alike.
3. Other key removable options available. See table on previous page.
4. Key not removable from spring-returned position

Illuminated Selector Switches 2-Position (Assembled)



2-Position Illuminated Selector Switches

Contact	Mounting	Style		Part Number			
		Operator Position		Type	Maintained	Spring Return from Right	
		L	R		L 	L 	
<i>Operator Only</i>					HW ^⑤ F-2 ^②	HW ^⑤ F-21 ^②	
1NO-1NC	1 2	0 X	X 0	Full Voltage	HW ^⑤ F-2F11QD- ^② - ^③	HW ^⑤ F-21F11QD- ^② - ^③	
				Transformer	120V	HW ^⑤ F-2F11H2D- ^②	HW ^⑤ F-21F11H2D- ^②
					240V	HW ^⑤ F-2F11M4D- ^②	HW ^⑤ F-21F11M4D- ^②
2NO	1 2	X 0	0 X	Full Voltage	HW ^⑤ F-2F20QD- ^② - ^③	HW ^⑤ F-21F20QD- ^② - ^③	
				Transformer	120V	HW ^⑤ F-2F20H2D- ^②	HW ^⑤ F-21F20H2D- ^②
					240V	HW ^⑤ F-2F20M4D- ^②	HW ^⑤ F-21F20M4D- ^②
2NO-2NC	1 2 3 4	0 X 0 X	X 0 X 0	Full Voltage	HW ^⑤ F-2F22QD- ^② - ^③	HW ^⑤ F-21F22QD- ^② - ^③	
				Transformer	120V	HW ^⑤ F-2F22H2D- ^②	HW ^⑤ F-21F22H2D- ^②
					240V	HW ^⑤ F-2F22M4D- ^②	HW ^⑤ F-21F22M4D- ^②
				480V	HW ^⑤ F-2F22T8D- ^②	HW ^⑤ F-21F22T8D- ^②	

- 1. In place of ^② specify Lens/LED color code.
- 2. In place of ^③ specify Full Voltage code.
- 3. In place of ^⑤ enter 1 for plastic bezel or 4 for metal bezel.
- 4. For nameplates, see page 678.
- 5. For contact assembly part numbers, see page 683.
- 6. Light is independent of switch position.
- 7. All assembled part numbers in catalog include standard Finger-Safe spring-up (HW-U...) contacts.
- 8. Yellow selector switch comes with white LED.**
- 9. Additional contact configurations available (up to 6 total contacts).
- 10. For Truth Tables see page 691.

② Lens/LED Color Code

Color	Code
Amber	A
Green	G
Red	R
Blue	S
White	W
Yellow	Y

③ Full Voltage Code

Full Voltage Models	
Voltage	Code
6VAC/DC	6V
12VAC/DC	12V
24VAC/DC	24V
120V AC	120V
240V AC	240V

⑤ Bezel Code

Type	Code
Plastic	1
Metal	4

Part Number Structure

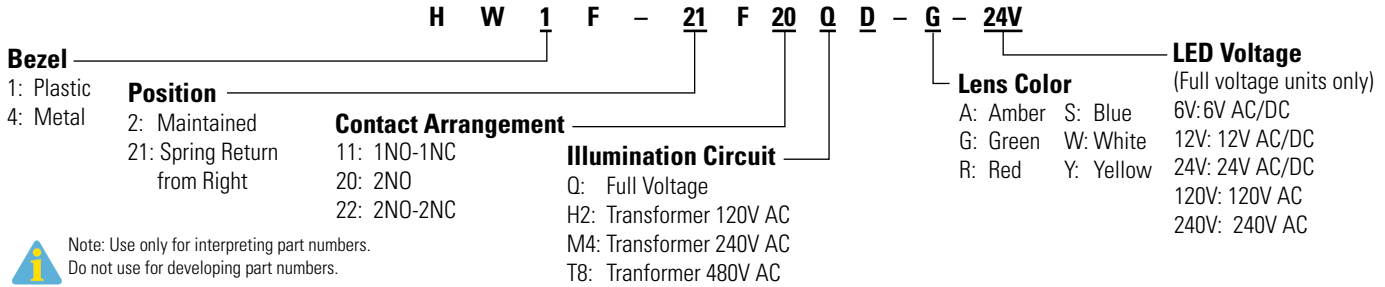

Illuminated Selector Switches 2-Position (Replacement Parts)

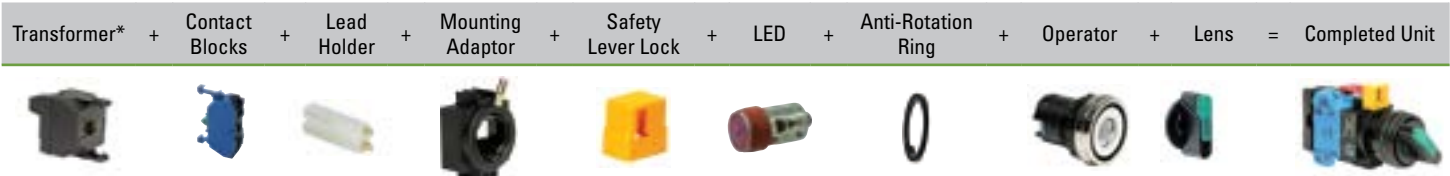

Note: *Transformer not needed with full voltage models.

Lamp Circuit Components

Style	Description	Terminals	Part Number
	For use with HW-CBL on all illuminated pushbutton units. One required for each deck (pair) of contacts.		HW-LH3
	For use with odd number of contacts.	Finger-Safe	HW-DA1FBN
	For use with even number of contacts.	Finger-Safe	TW-DA1FB
	120VAC 240VAC 480VAC	Finger-Safe	TW-F126B TW-F246B TW-F486B
	110VDC		HW-L16D

- DC-DC converter features spring-up terminals.
- DC-DC converter applicable voltage range 90-140V DC.

Operators

Style	Description	Plastic Bezel	Metal Bezel
	Maintained	HW1F-2	HW4F-2
	Spring return from right	HW1F-21	HW4F-21

Note: Illuminated knobs must be ordered separately.

Contact Blocks

Style	Contacts	1NO	1NC
	Finger-Safe Spring-Up Terminal	HW-U10-F HW-U10R-F (early make)	HW-U01-F HW-U01R-F (late break)

Contact Block Mounting Adaptor

Style	Part Number
	HW-CBL

- Used to mount contact blocks to operator (first pair only).
- IEC strongly recommends using the safety lever lock to prevent heavy vibration or maintenance personnel from inadvertently unlocking contacts.

Safety Lever Lock

Style	Part Number
	HW9Z-LS

Illuminated Knob

Appearance	Part Number
	HW9Z-FDY-⊙

Note: In place of ⊙, specify the Color Code.

⊙ Lens/LED Color Code

Color	Code	Color	Code
Amber	A	Blue	S
Green	G	White	W
Red	R	Yellow	Y

Anti-Rotation Ring

Style	Part Number
	HW9Z-RL

Note: Use with notched panel cutout to prevent unit rotation.

Lamps

Style	Voltage	Part Number
	6V AC/DC	LSTD-6⊙
	12V AC/DC	LSTD-1⊙
	24V AC/DC	LSTD-2⊙
	120V AC	LSTD-H2⊙
	240V AC	LSTD-M4⊙

- In place of ⊙, specify the LED Color Code.
- The LED contains a current-limiting resistor and reverse polarity protection diodes.
- Use white LED for yellow lens. Yellow LED not available.

Illuminated Selector Switches 3-Position (Assembled)



3-Position Illuminated Selector Switches

Contact	Mounting	Style			Part Number					
		Operator Position			Type	Maintained	Spring Return from Right	Spring Return from Left	Spring Return Two-Way	
		L	C	R		L C R	L C R	L C R	L C R	
<i>Operator Only</i>						HW⊙F-3②	HW⊙F-31②	HW⊙F-32②	HW⊙F-33②	
1NO-1NC	1 2	0 0	X 0	X X	Full Voltage	HW⊙F-3F11QD-②-③	HW⊙F-31F11QD-②-③	HW⊙F-32F11QD-②-③	HW⊙F-33F11QD-②-③	
					Transformer	120V	HW⊙F-3F11H2D-②	HW⊙F-31F11H2D-②	HW⊙F-32F11H2D-②	HW⊙F-33F11H2D-②
						240V	HW⊙F-3F11M4D-②	HW⊙F-31F11M4D-②	HW⊙F-32F11M4D-②	HW⊙F-33F11M4D-②
480V	HW⊙F-3F11T8D-②	HW⊙F-31F11T8D-②	HW⊙F-32F11T8D-②	HW⊙F-33F11T8D-②						
2NO	1 2	X 0	0 0	0 X	Full Voltage	HW⊙F-3F20QD-②-③	HW⊙F-31F20QD-②-③	HW⊙F-32F20QD-②-③	HW⊙F-33F20QD-②-③	
					Transformer	120V	HW⊙F-3F20H2D-②	HW⊙F-31F20H2D-②	HW⊙F-32F20H2D-②	HW⊙F-33F20H2D-②
						240V	HW⊙F-3F20M4D-②	HW⊙F-31F20M4D-②	HW⊙F-32F20M4D-②	HW⊙F-33F20M4D-②
480V	HW⊙F-3F20T8D-②	HW⊙F-31F20T8D-②	HW⊙F-32F20T8D-②	HW⊙F-33F20T8D-②						
2NC	1 2	0 X	X X	X 0	Full Voltage	HW⊙F-3F02QD-②-③	HW⊙F-31F02QD-②-③	HW⊙F-32F02QD-②-③	HW⊙F-33F02QD-②-③	
					Transformer	120V	HW⊙F-3F02H2D-②	HW⊙F-31F02H2D-②	HW⊙F-32F02H2D-②	HW⊙F-33F02H2D-②
						240V	HW⊙F-3F02M4D-②	HW⊙F-31F02M4D-②	HW⊙F-32F02M4D-②	HW⊙F-33F02M4D-②
480V	HW⊙F-3F02T8D-②	HW⊙F-31F02T8D-②	HW⊙F-32F02T8D-②	HW⊙F-33F02T8D-②						
2NO-2NC	1 2 3 4	X 0 0 X	0 0 X X	0 X X 0	Full Voltage	HW⊙F-3F22QD-②-③	HW⊙F-31F22QD-②-③	HW⊙F-32F22QD-②-③	HW⊙F-33F22QD-②-③	
					Transformer	120V	HW⊙F-3F22H2D-②	HW⊙F-31F22H2D-②	HW⊙F-32F22H2D-②	HW⊙F-33F22H2D-②
						240V	HW⊙F-3F22M4D-②	HW⊙F-31F22M4D-②	HW⊙F-32F22M4D-②	HW⊙F-33F22M4D-②
480V	HW⊙F-3F22T8D-②	HW⊙F-31F22T8D-②	HW⊙F-32F22T8D-②	HW⊙F-33F22T8D-②						
4NO	1 2 3 4	X 0 X 0	0 0 0 0	0 X 0 X	Full Voltage	HW⊙F-3F40QD-②-③	HW⊙F-31F40QD-②-③	HW⊙F-32F40QD-②-③	HW⊙F-33F40QD-②-③	
					Transformer	120V	HW⊙F-3F40H2D-②	HW⊙F-31F40H2D-②	HW⊙F-32F40H2D-②	HW⊙F-33F40H2D-②
						240V	HW⊙F-3F40M4D-②	HW⊙F-31F40M4D-②	HW⊙F-32F40M4D-②	HW⊙F-33F40M4D-②
480V	HW⊙F-3F40T8D-②	HW⊙F-31F40T8D-②	HW⊙F-32F40T8D-②	HW⊙F-33F40T8D-②						
4NC	1 2 3 4	0 X 0 X	X X X X	X 0 X 0	Full Voltage	HW⊙F-3F04QD-②-③	HW⊙F-31F04QD-②-③	HW⊙F-32F04QD-②-③	HW⊙F-33F04QD-②-③	
					Transformer	120V	HW⊙F-3F04H2D-②	HW⊙F-31F04H2D-②	HW⊙F-32F04H2D-②	HW⊙F-33F04H2D-②
						240V	HW⊙F-3F04M4D-②	HW⊙F-31F04M4D-②	HW⊙F-32F04M4D-②	HW⊙F-33F04M4D-②
480V	HW⊙F-3F04T8D-②	HW⊙F-31F04T8D-②	HW⊙F-32F04T8D-②	HW⊙F-33F04T8D-②						



- In place of ⊙ specify Lens/LED color code.
- In place of ⊙ specify Full Voltage code.
- In place of ⊙ enter 1 for plastic bezel or 4 for metal bezel.
- For nameplates, see page 678.
- For contact assembly part numbers, see page 683.
- Light is independent of switch position.
- All assembled part numbers in catalog include standard Finger-Safe spring-up (HW-U..) contacts.
- Yellow selector switch comes with white LED.**
- Additional contact configurations available (up to 6 total contacts).
- For Truth Tables see page 691.

② Lens/LED Color

Color	Code
Amber	A
Green	G
Red	R
Blue	S
White	W
Yellow	Y

③ Full Voltage Code

Full Voltage Models	
Voltage	Code
6VAC/DC	6V
12VAC/DC	12V
24VAC/DC	24V
120V AC	120V
240V AC	240V

⑤ Bezel Code

Type	Code
Plastic	1
Metal	4

Part Number Structure

H W 1 F - 31 F 20 Q D - G - 24V

Bezel
1: Plastic
4: Metal

Position
3: Maintained
31: Spring Return from Right
32: Spring Return from Left
33: Spring Return 2-Way

Contact Arrangement
11: 1NO-1NC 22: 2NO-2NC
20: 2NO 40: 4NO
02: 2NC 04: 4NC

Illumination Circuit
Q: Full Voltage
H2: Transformer 120V AC
M4: Transformer 240V AC
T8: Transformer 480V AC

Lens Color
A: Amber S: Blue
G: Green W: White
R: Red Y: Yellow

Full Voltage Code
6V: 6V AC/DC
12V: 12V AC/DC
24V: 24V AC/DC
120V: 120V AC
240V: 240V AC



Note: Use only for interpreting part numbers. Do not use for developing part numbers.

Illuminated Selector Switches 3-Position (Replacement Parts)

Transformer* + Contact Blocks + Lead Holder + Mounting Adaptor + Safety Lever Lock + LED + Anti-Rotation Ring + Operator + Lens = Completed Unit



*Transformer not needed with full voltage models.

Lamp Circuit Components

Style	Description	Terminals	Part Number
	For use with HW-CBL on all illuminated pushbutton units. One required for each deck (pair) of contacts.		HW-LH3
	For use with odd number of contacts.	Finger-Safe	HW-DA1FBN
	For use with even number of contacts.	Finger-Safe	TW-DA1FB
	120VAC 240VAC 480VAC	Finger-Safe	TW-F126B TW-F246B TW-F486B
	110VDC		HW-L16D



- DC-DC convertor features spring-up terminals.
- DC-DC convertor applicable voltage range 90-140V DC.

Operators

Style	Description	Plastic Bezel	Metal Bezel
	Maintained	HW1F-3	HW4F-3
	Spring return from right	HW1F-31	HW4F-31
	Spring return from left	HW1F-32	HW4F-32
	2-Way spring return	HW1F-33	HW4F-33



Illuminated knobs must be ordered separately.

Contact Blocks

Style	Contacts	1NO	1NC
	Finger-Safe Spring-Up Terminal	HW-U10-F HW-U10R-F (early make)	HW-U01-F HW-U01R-F (late break)

Contact Block Mounting Adaptor

Style	Part Number
	HW-CBL



- Used to mount contact blocks to operator (first pair only).
- IEEC strongly recommends using the safety lever lock to prevent heavy vibration or maintenance personnel from inadvertently unlocking contacts.

Safety Lever Lock

Style	Part Number
	HW9Z-LS

Illuminated Knob

Appearance	Part Number
	HW9Z-FDY-⊙



In place of ⊙, specify the Color Code.

⊙ Lens/LED Color Code

Color	Code	Color	Code
Amber	A	Blue	S
Green	G	White	W
Red	R	Yellow	Y

Anti-Rotation Ring

Style	Part Number
	HW9Z-RL



Use with notched panel cutout to prevent unit rotation.

Lamps

Style	Voltage	Part Number
	6V AC/DC	LSTD-6⊙
	12V AC/DC	LSTD-1⊙
	24V AC/DC	LSTD-2⊙
	120V AC	LSTD-H2⊙
	240V AC	LSTD-M4⊙



- In place of ⊙, specify the LED Color Code.
- The LED contains a current-limiting resistor and reverse polarity protection diodes.
- Use white LED for yellow lens. Yellow LED not available.

Mono Lever Switches 2-Position (Assembled)



2-Position Mono Lever Switches

Style	Part Number	Description
HW1M Standard Lever	HW1M-F1010-20	Maintained up and down
	HW1M-F2020-20	Spring return up and down
	HW1M-F1010-40	Maintained up and down
	HW1M-F2020-40	Spring return up and down
	HW1M-F0101-20	Maintained right and left
	HW1M-F0202-20	Spring return right and left
	HW1M-F0101-40	Maintained right and left
HW1M-L Interlocking Lever	HW1M-F0202-40	Spring return right and left
	HW1M-LF1010-20	Maintained up and down
	HW1M-LF2020-20	Spring return up and down
	HW1M-LF1010-40	Maintained up and down
	HW1M-LF2020-40	Spring return up and down
	HW1M-LF0101-20	Maintained right and left
	HW1M-LF0202-20	Spring return right and left
	HW1M-LF0101-40	Maintained right and left
	HW1M-LF0202-40	Spring return right and left



All Assembled units with Finger-Safe spring-up (HW-U...) contacts

Circuit Diagrams

2 Position Left/Right

Circuit Number	Contact Mounting		Position		
	No.		Left	Center	Right
20	1	HW-U10-F	X	0	0
	2	HW-U10-F	0	0	X
40	1	HW-U10-F	X	0	0
	2	HW-U10-F	0	0	X
	3	HW-U10-F	X	0	0
	4	HW-U10-F	0	0	X

2 Position Up/Down

Circuit Number	Contact Mounting		Position		
	No.		Down	Center	Up
20	1	HW-U10-F	X	0	0
	2	HW-U10-F	0	0	X
40	1	HW-U10-F	X	0	0
	2	HW-U10-F	0	0	X
	3	HW-U10-F	X	0	0
	4	HW-U10-F	0	0	X

Part Number Structure

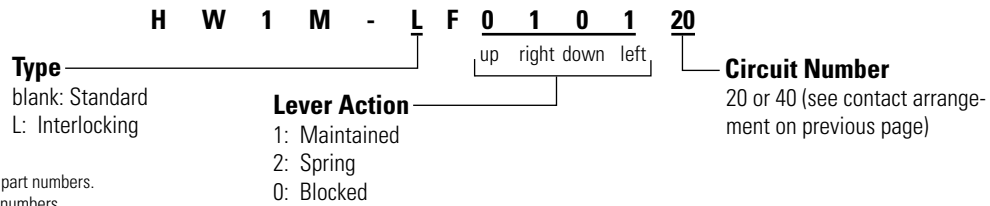

Note: Use only for interpreting part numbers. Do not use for developing part numbers.

Mono Lever Switches 2-Position (Sub-assembled) Part Numbers

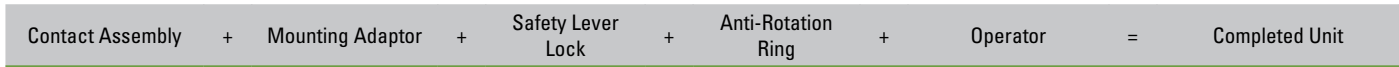

Contact Blocks

Style	Contacts	1NO	1NC
	Finger-Safe Spring-Up Terminal	HW-U10-F	HW-U01-F
		HW-U10R-F (early make)	HW-U01R-F (late break)
	Dummy Block	HW-DB	

Anti-Rotation Ring

Style	Part Number
	HW9Z-RL

Use with notched panel cutout to prevent unit rotation.

Operators

Style	Description	Part Number
	Standard	Maintained Up/Down
	Spring return Up/Down	HW1M-2020
	Maintained Left/Right	HW1M-0101
	Spring return Left/Right	HW1M-0202
	Interlocking	Maintained Up/Down
	Spring return Up/Down	HW1M-L2020
	Maintained Left/Right	HW1M-L0101
	Spring return Left/Right	HW1M-L0202

Contact Block Mounting Adaptor

Style	Part Number
	HW-CB2C

- 1. Used to mount contact blocks to operator (first pair only).
- 2. IDEC strongly recommends using the safety lever lock (included) to prevent heavy vibration or maintenance personnel from inadvertently unlocking contacts.

Safety Lever Lock

Style	Part Number
	HW9Z-LS

Replacement Parts

Item	Part Number
Black Cap	 HW9Z-CPM
Boot	
	HW9Z-BLM (fits standard operator only)

Mono Lever Switches 3- & 4-Position (Assembled)



3-Position

Style	Part Number	Description
HW1M Standard Lever	HW1M-F0121-12N3	Maintained right and left, spring return down
	HW1M-F0222-12N3	Spring return right, down, left
HW1M-L Interlocking Lever	HW1M-LF0121-12N3	Maintained right and left, spring return down
	HW1M-LF0222-12N3	Spring return right, down, left

Circuit Diagram

Circuit Number	Contact Mounting		Position				
	No.		Down	Left	Center	Up	Right
12N3	1	HW-U01-F	0	0	0	0	X
	2	HW-U01-F	X	0	0	0	0
	3	HW-U10-F	0	X	0	0	0

4-Position

Style	Part Number	Description
HW1M Standard Lever	HW1M-F1111-22N9	Maintained all positions
	HW1M-F1212-22N9	Maintained up and down, spring left and right
	HW1M-2121-22N9	Spring up and down, maintained left and right
	HW1M-2222-22N9	Spring return all positions
HW1M-L Interlocking Lever	HW1M-LF1111-22N9	Maintained all positions
	HW1M-LF1212-22N9	Maintained up and down, spring left and right
	HW1M-LF2121-22N9	Spring up and down, maintained left and right
	HW1M-LF2222-22N9	Spring return all positions

Circuit Diagram

Circuit Number	Contact Mounting		Position				
	No.		Down	Left	Center	Up	Right
22N9	1	HW-U01-F	0	0	0	0	X
	2	HW-U01-F	X	0	0	0	0
	3	HW-U10-F	0	X	0	0	0
	4	HW-U10-F	0	0	0	X	0



All assembled part numbers in catalog include Finger-Safe spring-up (HW-U...) contacts.

Part Number Structure

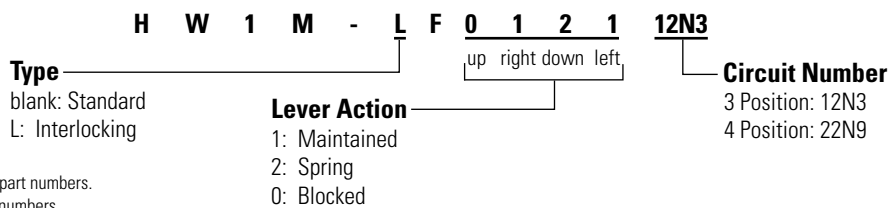

Note: Use only for interpreting part numbers. Do not use for developing part numbers.

Mono Lever Switches 3 & 4-Position (Sub-assembled) Part Numbers

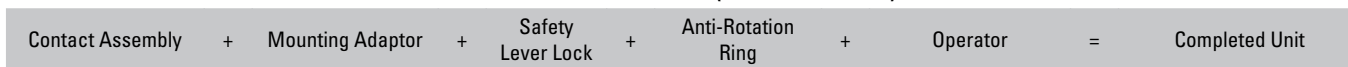

Contact Blocks

Style	Contacts	1NO	1NC
	Finger-Safe Spring-Up Terminal	HW-U10-F	HW-U01-F
		HW-U10R-F (early make)	HW-U01R-F (late break)
	Dummy Block	HW-DB	

Contact Block Mounting Adaptor

Style	Part Number
	HW-CB2C

1. Used to mount contact blocks to operator (first pair only).
 2. IDEC strongly recommends using the safety lever lock (included) to prevent heavy vibration or maintenance personnel from inadvertently unlocking contacts.

Safety Lever Lock

Style	Part Number
	HW9Z-LS

Anti-Rotation Ring

Style	Part Number
	HW9Z-RL

Use with notched panel cutout to prevent unit rotation.

Operators

Style	Description	Part Number
	Combination, 3 position	HW1M-0121
	Spring return, 3 position	HW1M-0222
	Maintained, 4 position	HW1M-1111
	Combination, 4 position	HW1M-1212
	Combination, 4 position	HW1M-2121
	Spring return, 4 position	HW1M-2222
	Combination, 3 position	HW1M-L0121
	Spring return, 3 position	HW1M-L0222
	Maintained, 4 position	HW1M-L1111
	Combination, 4 position	HW1M-L1212
	Combination, 4 position	HW1M-L2121
	Spring return, 4 position	HW1M-L2222

Replacement Parts

Item	Part Number
Black Cap 	HW9Z-CPM
Boot 	HW9Z-BLM (fits standard operator only)

Pushbutton Selectors (Assembled)



2-Position Pushbutton Selectors

Cam	Contacts	Mounting	Operator Position				Part Number	
			Left		Right			
			Normal	Push	Normal	Push		
A	<i>Operator Only</i>						HW1R-2A-①	
	1NO-1NC	1	HW-U10-F	0	X	0	X	HW1R-2AF11-①
		2	HW-U01-F	X	0	0	0	
	2NO	1	HW-U10-F	0	X	0	X	HW1R-2AF20-①
2		HW-U10-F	0	X	X	X		
2NO-2NC	1	HW-U10-F	0	X	0	X	HW1R-2AF22-①	
	2	HW-U01-F	X	0	0	0		
	3	HW-U10-F	0	X	0	X		
	4	HW-U01-F	X	0	0	0		
D	<i>Operator Only</i>						HW1R-2D-①	
	2NO	1	HW-U10-F	0	X	0	0	HW1R-2DF20-①
		2	HW-U10-F	0	0	0	X	
	2NO-2NC	1	HW-U10-F	0	X	0	0	HW1R-2DF22N1-①
2		HW-U10-F	0	0	0	X		
3		HW-U01-F	X	0	X	X		
4		HW-U01-F	X	X	X	0		
E	<i>Operator Only</i>						HW1R-2E-①	
	2NO-2NC	1	HW-U10-F	0	X	0	0	HW1R-2EF22N1-①
		2	HW-U10-F	0	0	0	X	
		3	HW-U01-F	0	0	X	X	
4		HW-U01-F	X	X	0	0		
F	<i>Operator Only</i>						HW1R-2F-①	
	2NO-2NC	1	HW-U10-F	0	0	0	X	HW1R-2FF22N1-①
		2	HW-U10-F	0	X	0	0	
		3	HW-U01-F	0	0	X	0	
4		HW-U01-F	X	0	0	0		
N	<i>Operator Only</i>						HW1R-2N-①	
	2NO-2NC	1	HW-U01-F	0	0	X	0	HW1R-2NF22N2-①
		2	HW-U10-F	0	X	0	X	
		3	HW-U01-F	0	0	X	0	
4		HW-U10-F	0	X	0	X		
T	<i>Operator Only</i>						HW1R-2T-①	
	2NO-2NC	1	HW-U10-F	0	X	X		HW1R-2TF22N1-①
		2	HW-U10-F	0	X	X	Blocked	
		3	HW-U01-F	X	0	0		
4		HW-U01-F	X	0	0			

① Button Color Code

Color	Code	Color	Code
Black	B	White	W
Green	G	Yellow	Y
Red	R		
Blue	S		

1. All assembled part numbers in catalog include Finger-Safe spring-up (HW-U...) contacts.
2. Operator only models come with operator and button.

Part Number Structure

H W 1 R - 2 D F 22N1 - R

Operator

- A: Cam A
- D: Cam D
- E: Cam E
- F: Cam F
- N: Cam N
- T: Cam T

Contact Arrangement Code

- 11: 1NO-1NC
- 20: 2NO
- (For additional contact codes see previous page)

Button Colors

- B: Black
- G: Green
- R: Red
- S: Blue
- W: White
- Y: Yellow



Note: Use only for interpreting part numbers. Do not use for developing part numbers.

Pushbutton Selectors (Sub-assembled)

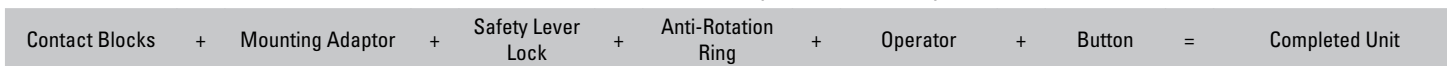

Contact Blocks

Style	Contacts	1NO	1NC
	Finger-Safe Spring-Up Terminal	HW-U10-F	HW-U01-F
		HW-U10R-F (early make)	HW-U01R-F (late break)
	Dummy Block	HW-DB	

Safety Lever Lock

Style	Part Number
	HW9Z-LS

Buttons

Style	Part Number
Round Flush	HW1A-B1-Ⓢ



In place of Ⓢ, specify the Button Color Code from table below.

Ⓢ Button Color Code

Color	Code	Color	Code
Black	B	White	W
Green	G	Yellow	Y
Red	R		
Blue	S		

Contact Block Mounting Adaptor

(safety lever lock included)

Style	Part Number
	HW-CB2C



- Used to mount contact blocks to operator (first pair only).
- IEDEC strongly recommends using the safety lever lock (included) to prevent heavy vibration or maintenance personnel from inadvertently unlocking contacts.

Anti-Rotation Ring

Style	Part Number
	HW9Z-RL



Use with notched panel cutout to prevent unit rotation.

Operators

Style	Description	Part Number
	Cam A	HW1R-2A
	Cam D	HW1R-2D
	Cam E	HW1R-2E
	Cam F	HW1R-2F
	Cam N	HW1R-2N
	Cam T	HW1R-2T

Dual Pushbutton Switches

Key features:

- Two pushbuttons and a pilot light are integrated into one space-saving ø22 mm control unit.
- Momentary and interlock types are available for pushbuttons. Interlock type prevents both buttons from being pressed at the same time.
- Pilot lights are available in full voltage and transformer with LED.
- IP40 protection, IP65 when using silicon boot.



Applications:

- Ideal for use as power switches and start/stop switches (available with I/ON and O/OFF markings on the buttons and a pilot light in the center).
- Interlock type prevents two pushbuttons from being pressed at the same time.



Dual Pushbutton Switches (Assembled) Part Numbers

Without Center Pilot Light

Operation Type	Button Style	Image	Contact Arrangement		Part Number	Ⓔ Button Color Code	Ⓕ Legend Code		
			Top Button	Bottom Button					
Momentary	Flush (top) Flush (bottom)		1NO	1NC	HW7D-B11F1001-ⒺⒻ	GR: Green (top) Red (bottom)	Blank: Without legend		
			1NO	1NO	HW7D-B11F1010-ⒺⒻ				
			1NO-1NC	1NO-1NC	HW7D-B11F1111-ⒺⒻ				
			2NO	2NC	HW7D-B11F2002-ⒺⒻ				
			2NO	2NO	HW7D-B11F2020-ⒺⒻ				
Momentary	Flush (top) Extended (bottom)		1NO	1NC	HW7D-B12F1001-ⒺⒻ			WB: White (top) Black (bottom)	1: I/ON (top) O/OFF (bottom)
			1NO	1NO	HW7D-B12F1010-ⒺⒻ				
			1NO-1NC	1NO-1NC	HW7D-B12F1111-ⒺⒻ				
			2NO	2NC	HW7D-B12F2002-ⒺⒻ				
			2NO	2NO	HW7D-B12F2020-ⒺⒻ				
Interlock*	Flush (top) Flush (bottom)		1NO	1NC	HW7D-B21F1001-ⒺⒻ	WB: White (top) Black (bottom)	1: I/ON (top) O/OFF (bottom)		
			1NO	1NO	HW7D-B21F1010-ⒺⒻ				
			1NO-1NC	1NO-1NC	HW7D-B21F1111-ⒺⒻ				
			2NO	2NC	HW7D-B21F2002-ⒺⒻ				
			2NO	2NO	HW7D-B21F2020-ⒺⒻ				
	Flush (top) Extended (bottom)		1NO	1NC	HW7D-B22F1001-ⒺⒻ			WB: White (top) Black (bottom)	1: I/ON (top) O/OFF (bottom)
			1NO	1NO	HW7D-B22F1010-ⒺⒻ				
			1NO-1NC	1NO-1NC	HW7D-B22F1111-ⒺⒻ				
			2NO	2NC	HW7D-B22F2002-ⒺⒻ				
			2NO	2NO	HW7D-B22F2020-ⒺⒻ				

1. *Interlock type prevents both top and bottom buttons from being pressed simultaneously.
 2. Clear silicon rubber cover part number HW9Z-D7D.
 3. Additional contact configurations available (up to 6 total contacts).

With Center Pilot Light

Operation Type	Button Style		Top Button	Bottom Button	Part Number
Momentary	Flush (Top) Flush (Bottom)	Flush (top) Flush (bottom)	1NO	1NC	HW7D-L11F1001②③-④⑤
			1NO	1NO	HW7D-L11F1010②③-④⑤
			1NO-1NC	1NO-1NC	HW7D-L11F1111②③-④⑤
			2NO	2NC	HW7D-L11F2002②③-④⑤
			2NO	2NO	HW7D-L11F2020②③-④⑤
	Flush (Top) Extended (Bottom)		1NO	1NC	HW7D-L12F1001②③-④⑤
			1NO	1NO	HW7D-L12F1010②③-④⑤
			1NO-1NC	1NO-1NC	HW7D-L12F1111②③-④⑤
			2NO	2NC	HW7D-L12F2002②③-④⑤
			2NO	2NO	HW7D-L12F2020②③-④⑤
Interlock*	Flush (Top) Flush (Bottom)	Flush (top) Extended (bottom)	1NO	1NC	HW7D-L21F1001②③-④⑤
			1NO	1NO	HW7D-L21F1010②③-④⑤
			1NO-1NC	1NO-1NC	HW7D-L21F1111②③-④⑤
			2NO	2NC	HW7D-L21F2002②③-④⑤
			2NO	2NO	HW7D-L21F2020②③-④⑤
	Flush (Top) Extended (Bottom)		1NO	1NC	HW7D-L22F1001②③-④⑤
			1NO	1NO	HW7D-L22F1010②③-④⑤
			1NO-1NC	1NO-1NC	HW7D-L22F1111②③-④⑤
			2NO	2NC	HW7D-L22F2002②③-④⑤
			2NO	2NO	HW7D-L22F2020②③-④⑤

- 1. *Interlock type prevents both top and bottom buttons from being pressed simultaneously.
- 2. Clear silicon rubber cover part number HW9Z-D7D.
- 3. All assembled part numbers in catalog include Finger-Safe spring-up (HW-U...) contacts.

② Pilot Light Illumination & Voltage Code

Full Voltage	
Voltage	Code
6V AC/DC, LED	Q2
12V AC/DC, LED	Q3
24V AC/DC, LED	Q4
120V AC, LED	Q8
Step-Down Transformer (6V Secondary LED Voltage)	
Voltage	Code
120V AC, LED	H22
240V AC, LED	M42
480V AC, LED	T82

③ Pilot Lamp Color Code

Color	Code
Amber	A
Green	G
Red	R
Blue	S
White	W

④ Pushbutton Color Code

Color		Code
Top	Green	GR
Bottom	Red	
Top	White	WB
Bottom	Black	

⑤ Engraving Codes

Engraving		Code
No Engraving	Blank	
I/ON	Top	1
O/OFF	Bottom	

Switches & Pilot Devices

Signaling Lights

Relays & Sockets

Timers

Contactors

Terminal Blocks

Circuit Breakers

Switches & Pilot Devices

Signalizing Lights

Relays & Sockets

Timers

Contactors

Terminal Blocks

Circuit Breakers

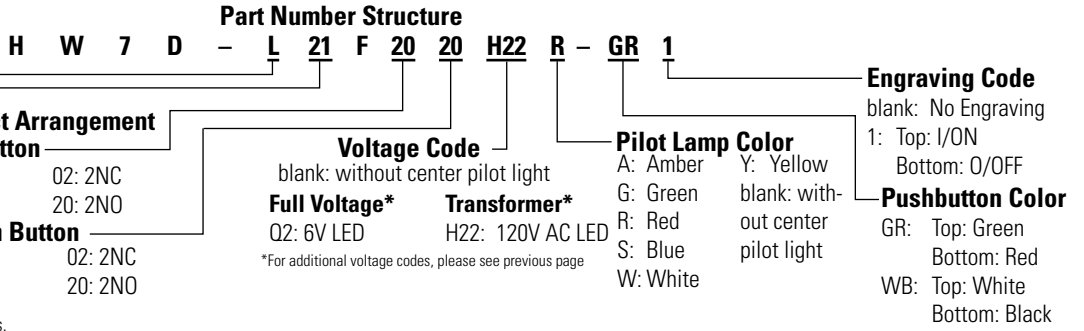

Dual Pushbutton Switches (Sub-assembled) Part Numbers



Lamp Circuit Components with Finger-Safe Terminals

Style	Description	Part Number
Lead Holder	For use with HW-CBL on all illuminated pushbutton units. One required for each deck (pair) of contacts.	HW-LH3
Dummy Block with Full Voltage Adaptor	For use with odd number of contacts.	HW-DA1FBN
Full Voltage Adaptor	For use with even number of contacts.	TW-DA1FB
Transformer Unit (6V secondary voltage)	120VAC 240VAC 480VAC	TW-F126B TW-F246B TW-F486B

Contact Blocks

Style	Contacts	1NO	1NC
Finger-Safe Spring-Up Terminal		HW-U10-F HW-U10R-F (early make)	HW-U01-F HW-U01R-F (late break)
Dummy Block		HW-DB	

Contact Block Mounting Adaptor

Style	Part Number
Non-illuminated	HW-CB2C
Illuminated (with Pilot Light)	HW-CBL

- Used to mount contact blocks to operator (first pair only).
- IEEC strongly recommends using the safety lever lock (included) to prevent heavy vibration or maintenance personnel from inadvertently unlocking contacts.

Safety Lever Lock

Style	Part Number
	HW9Z-LS

Anti-Rotation Ring

Appearance	Part Number
	HW9Z-RL

- Use with notched panel cutout to prevent unit rotation.

Engraving Codes

Engraving	Code
No Engraving	Blank
I/ON	Top
O/OFF	Bottom

Lamps/Lens

Style	Voltage	Part Number
LED	6V AC/DC	LSTD-6Ⓢ
	12V AC/DC	LSTD-1Ⓢ
	24V AC/DC	LSTD-2Ⓢ
	120V AC	LSTD-H2Ⓢ
Non-illuminated	240V AC	LSTD-M4Ⓢ
		HW9Z-B7B
Illuminated		HW9Z-L7W

- In place of Ⓢ, specify the LED Color Code.
- The LED contains a current-limiting resistor and reverse polarity protection diodes.

LED Color Code

Color	Code	Color	Code
Amber	A	Blue	S
Green	G	White	W
Red	R		

Operators

Style	Button	Part Number
Momentary	Flush (top)	HW7D-*11Ⓢ-Ⓢ
	Flush (bottom)	
	Flush (top)	HW7D-*12Ⓢ-Ⓢ
	Extended (bottom)	
Interlock	Flush (top)	HW7D-*21Ⓢ-Ⓢ
	Flush (bottom)	
	Flush (top)	HW7D-*22Ⓢ-Ⓢ
	Extended (bottom)	

- Instead of * insert:
B: Non-illuminated
L: Illuminated

Pushbutton Color Code

Color	Code	Color	Code
Top: Green	GR	Top: White	WB
Bottom: Red		Bottom: Black	

Contact Arrangement Chart

Contact Block Mounting Position Example

Contact Arrangement			Contact Block		Top Button		Bottom Button		
Top Button	Bottom Button	Contact Code	Mounting Position	Type	Normal	Push	Normal	Push	
1NO	1NO	1010	1	NO		X			
			2	NO				X	
1NO	1NC	1001	1	NO		X			
			2	NC			X		
1NC	1NO	0110	1	NC	X				
			2	NO				X	
1NC	1NC	0101	1	NC	X				
			2	NC			X		
1NO	2NO	1020	1	NO		X			
			2	NO				X	
			3	Dummy					
			4	NO					X
1NO	1NO-1NC	1011	1	NO		X			
			2	NO				X	
			3	Dummy					
			4	NC				X	
1NO	2NC	1002	1	NO		X			
			2	NC			X		
			3	Dummy					
			4	NC				X	
1NC	2NO	0120	1	NC	X				
			2	NO				X	
			3	Dummy					
			4	NO					X
1NC	1NO-1NC	0111	1	NC	X				
			2	NO				X	
			3	Dummy					
			4	NC				X	
1NC	2NC	0102	1	NC	X				
			2	NC			X		
			3	Dummy					
			4	NC				X	
2NO	1NO	2010	1	NO		X			
			2	NO				X	
			3	NO		X			
			4	Dummy					
2NO	1NC	2001	1	NO		X			
			2	NC			X		
			3	NO		X			
			4	Dummy					
1NO-1NC	1NO	1110	1	NO		X			
			2	NO				X	
			3	NC	X				
			4	Dummy					
1NO-1NC	1NC	1101	1	NO		X			
			2	NC			X		
			3	NC	X				
			4	Dummy					

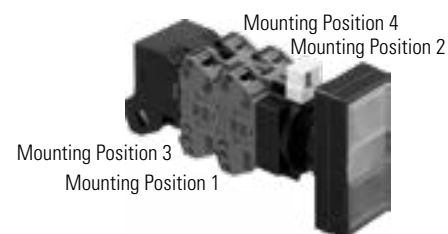

Switches & Pilot Devices

Signaling Lights

Relays & Sockets

Timers

Contactors

Terminal Blocks

Circuit Breakers

 1. Transformers can have two or four contact blocks only.
2. Contact blocks 1 and 3 are actuated by the top button. Contact blocks 2 and 4 are actuated by the bottom button.

Contact Arrangement Chart (con't)

Contact Arrangement			Contact Block		Top Button		Bottom Button	
Top Button	Bottom Button	Contact Code	Mounting Position	Type	Normal	Push	Normal	Push
2NC	1NO	0210	1	NC	X			
			2	NO			X	
			3	NC	X			
			4	Dummy				
2NC	1NC	0201	1	NC	X			
			2	NC			X	
			3	NC	X			
			4	Dummy				
2NO	2NO	2020	1	NO		X		
			2	NO			X	
			3	NO		X		
			4	NO			X	
2NO	1NO-1NC	2011	1	NO		X		
			2	NO			X	
			3	NO		X		
			4	NC			X	
2NO	2NC	2002	1	NO		X		
			2	NC			X	
			3	NO		X		
			4	NC			X	
1NO-1NC	2NO	1120	1	NO		X		
			2	NO			X	
			3	NC	X			
			4	NO			X	
1NO-1NC	1NO-1NC	1111	1	NO		X		
			2	NO			X	
			3	NC	X			
			4	NC			X	
1NO-1NC	2NC	1102	1	NO		X		
			2	NC			X	
			3	NC	X			
			4	NC			X	
2NC	2NO	0220	1	NC	X			
			2	NO			X	
			3	NC	X			
			4	NO			X	
2NC	1NO-1NC	0211	1	NC	X			
			2	NO			X	
			3	NC	X			
			4	NC			X	
2NC	2NC	0202	1	NC	X			
			2	NC			X	
			3	NC	X			
			4	NC			X	

Contact Block Mounting Position Example

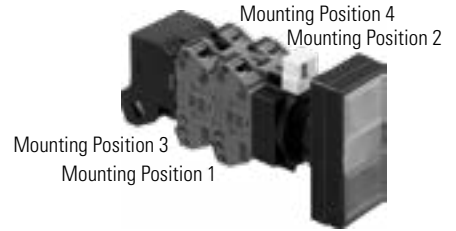

Contactor Reset Button



Reset Buttons (Assembled)

	Plastic Bezel	Metal Bezel
(Blank)	HW1B-M1RS-⊙T	HW4B-M1RS-⊙T
Engraved "R"	HW1B-M1RS-⊙T-ENG-R	HW4B-M1RS-⊙T-ENG-R

- 1. In place of ⊙ specify Button Color Code.
- 2. 130mm (5.1") overall length.
- 3. 16mm flat base for easy alignment

⊙ Button Color Code

Color	Code	Color	Code
Black	B	White	W
Green	G	Yellow	Y
Red	R		
Blue	S		

Contactor Reset Button (Sub-assembled)



Rod

Style	Part Number
	HW9Z-RS-TK2141

Button

Style	Part Number
	HW1A-B1-⊙

 In place of ⊙, specify the Button Color Code from table.

Operator

Style	Plastic	Metal
	HW1B-M0	HW4B-M0
		

⊙ Button Color Code

Color	Code	Color	Code
Black	B	White	W
Green	G	Yellow	Y
Red	R		
Blue	S		

Nameplates - HW Series

	HWAM-Black Plastic	HWAQ-Black Plastic	HWAS-Black Plastic	HWAV-Yellow Plastic
Nameplate (blank engraving plate included)	HWAM-OB	HWAQ-OB	HWAS-OB	HWAV-0 HWAV5-0†
Nameplate (engraved)	HWAM-⓪	HWAQ-⓪	HWAS-⓪	HWAV-27* HWAV5-27†
Additional Insert (blank)	HWNP-0	HWNP-0	HWNP Dimensions 	
Additional Insert (engraved)	HWNP-⓪	HWNP-⓪		

- 1. In place of ⓪, insert either the standard legend code from table below or custom engraving delimited by " ".
- 2. Standard engravings are available at no charge.
- 3. * HWAV-27 comes engraved "Emergency Stop" as shown in drawing.
- 4. † HWAV5-27 and HWAV5-0 for 60mm diameter E-Stops (80mm diameter nameplate).

Standard Legend Codes

Pushbuttons				Pushbuttons/Selector Switches				Selector Switches	
Legend	Code	Legend	Code	Legend	Code	Legend	Code	Legend	Code
AUTO	101	OPEN	116	AUTO-MAN	201	REV-FOR	216	AUTO-MAN-OFF	301
CLOSE	102	OUT	117	CLOSE-OPEN	202	RUN-JOG	217	AUTO-OFF-MAN	302
DOWN	103	RAISE	118	DOWN-UP	203	RUN-SAFE	218	CLOSE-OFF-OPEN	303
EMERG.STOP	104	RESET	119	FAST-SLOW	204	SAFE-RUN	219	DOWN-OFF-SLOW	304
FAST	105	REVERSE	120	FOR-REV	205	SLOW-FAST	220	FAST-OFF-SLOW	305
FORWARD	106	RUN	121	HAND-AUTO	206	START-STOP	221	FOR-OFF-REV	306
HAND	107	SLOW	122	HIGH-LOW	207	STOP-START	222	LEFT-OFF-RIGHT	307
HIGH	108	START	123	JOG-RUN	208	UP-DOWN	223	LOWER-OFF-RAISE	308
IN	109	STOP	125	LEFT-RIGHT	209	OI (Int'l OFF ON)	250	OFF-MAN-AUTO	309
INCH	110	TEST	126	LOWER-RAISE	210			OFF-SLOW-FAST	310
JOG	111	UP	127	MAN-AUTO	211			OFF-1-2	311
LOW	112	I (Int'l On)	150	OFF-ON	212			OPEN-OFF-CLOSE	312
LOWER	113	O (Int'l Off)	151	ON-OFF	213			SLOW-OFF-FAST	313
OFF	114	EMO	152	OPEN-CLOSE	214			SUMMER-OFF-WINTER	314
ON	115			RAISE-LOWER	215			UP-OFF-DOWN	315
								1-OFF-2	316
								HAND-OFF-AUTO	317

- 1. To order engraved nameplates, add legend code to nameplate part number.
- 2. Character height based on the number of characters and size of nameplate. Standard character size is 3/16".
- 3. Nameplates with standard legends are the same list price as blank nameplates.
- 4. Nameplates have built-in anti-rotation feature for use with notched panel cut-outs. Additional anti-rotation ring (HW9Z-RL) is not necessary.

Nameplates Order Form – HW Series

Copy this order form and use it to specify Letter Height, Custom Engravings, Location of Engraving on Nameplate, and Quantity Desired.

To ensure engraving accuracy, fax it to your IDEC representative or Distributor.

Your Company: _____
 Name: _____
 Telephone: _____
 Fax & Email: _____

IDEC Rep/Distributor Contact: _____
 PO number (if known): _____
 IDEC Rep/Distributor Phone: _____
 IDEC Rep/Distributor Fax & Email: _____

HWAM Nameplate

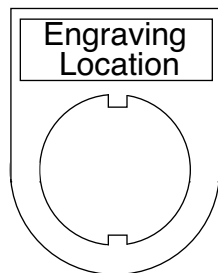

Step 1.
Choose Letter Size - 7/64" or 1/8".
 Check the box for the letter size you want. Then write your lettering in box below the check boxes. Note: 1/8" size letters cannot exceed 9 characters.

7/64" Letter Size 11 characters maximum (for 7/64" size letters)
 1/8" Letter Size 9 characters maximum (for 7/8" size letters)

Step 2.
Specify Quantity.
 Enter the number of nameplates desired in the box on the right.

Qty

1 2 3 4 5 6 7 8 9 10 11

Sample Letter Sizes
 7/64" Letters: A B C D
 1/8" Letters: A B C D

HWAQ Nameplate

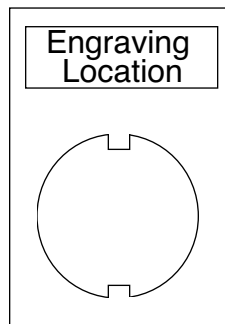

Step 1.
Choose Letter Size - 7/64" or 1/8".
 Check the box for the letter size you want. Then write your lettering in box below the check boxes. Note: 1/8" size letters cannot exceed 9 characters.

7/64" Letter Size 11 characters maximum (for 7/64" size letters)
 1/8" Letter Size 9 characters maximum (for 1/8" size letters)

Step 2.
Specify Quantity.
 Enter the number of nameplates desired in the box on the right.

Qty

1 2 3 4 5 6 7 8 9 10 11

Sample Letter Sizes
 7/64" Letters: A B C D
 1/8" Letters: A B C D

HWAS Nameplate

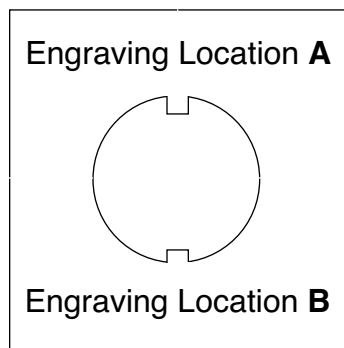

Step 1.
Choose Letter Size - 3/32" or 1/8".
 Check the box for the letter size you want. Then write your lettering in box below the check boxes. Note: 1/8" size letters cannot exceed 14 characters.

3/32" Letter Size 20 characters maximum (for 3/32" size letters)
 1/8" Letter Size 14 characters maximum (for 1/8" size letters)

Step 2.
Specify Quantity.
 Enter the number of nameplates desired in the box on the right.

Qty

A 1 2 3 4 5 6 7 8 9 10 11 12 13 14 15 16 17 18 19 20

Step 3.
Specify Location.
 Enter the location of engraving (A or B or Both), in box on the right.

Location

B 1 2 3 4 5 6 7 8 9 10 11 12 13 14 15 16 17 18 19 20

Sample Letter Sizes
 3/32" Letters: A B C D
 1/8" Letters: A B C D

Switch Engraving Order Form – HW Series

Copy this order form and use it to specify Letter Height, Maximum Number of Lines and Text to be engraved.

To ensure engraving accuracy, fax it to your IDEC representative or Distributor.

Your Company: _____
 Name: _____
 Address: _____
 PO: _____

Telephone: _____
 Fax: _____
 Email: _____
 Part Number to be Engraved: _____

Please check one of the boxes below to indicate your choice of engraving options:

ø29mm, ø40mm Mushroom Head

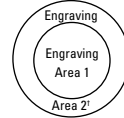

	# of Lines	Letter Height	Max. Characters Per Line
<input type="checkbox"/>	1	5/32	5
<input type="checkbox"/>		1/8	6
<input type="checkbox"/>	2	5/32	5
<input type="checkbox"/>		1/8	6
<input type="checkbox"/>	3	1/8	6
<input type="checkbox"/>	4	3/32	5

	# of Lines	Letter Height	Max. Characters Per Line
<input type="checkbox"/>	1	5/32	5
<input type="checkbox"/>		1/8	5
<input type="checkbox"/>	2	5/32	5
<input type="checkbox"/>		1/8	6
<input type="checkbox"/>	3	1/8	5
<input type="checkbox"/>	4	3/32	5

		# of Lines	Letter Height	Max. Characters Per Line
<input type="checkbox"/>	Engraving Area 1	1	5/32	5
<input type="checkbox"/>			1/8	5
<input type="checkbox"/>	Engraving Area 2	1	5/32	7
<input type="checkbox"/>			1/8	7



- Above mentioned specifications hold true for standard size pushbuttons (round and square).
- *Engraving Area 2 can be engraved for 40mm mushroom Head non-Illuminated push button only.
- Engraving is done on the button itself for non-Illuminated push buttons and on marking plate for illuminated push buttons and pilot lights.
- Please enter text exactly how you want it engraved, take care to emphasize capital or small letters.

Enter text to be engraved:

Sample Letter Sizes

1/8 Letters: **OPEN**

5/32 Letters: **OPEN**

Line 1: _____
 Line 2: _____
 Line 3: _____
 Line 4: _____

For IDEC Internal Use Only:
 Work Order #: _____

Accessories

Item	Appearance	Description/Usage	Part Number	
Locking Ring Wrench		Metallic tool used to tighten the plastic locking ring when installing the HW series in a panel	MW9Z-T1	
Lamp/LED Removal Tool		Rubber tool makes lamp/LED removal easier.	OR-55	
Anti-Rotation Ring		Prevents rotation of switches in panel. (included with all assembled switches except pilot lights)	for notched panel cutout (standard)	HW9Z-RL
			for round panel cutout	LW9Z-L
Rubber Mounting Hole Plug		Black rubber plug fills unused 7/8" mounting holes in panel.	OB-31	
Metallic Mounting Hole Plug		For plugging unused 7/8" mounting holes in the panel. Tighten the attached locking ring to a torque of 12 kfg-cm maximum Degree of protection: IP66	LW9Z-BM	
Pushbutton Clear Boot		Used to cover and protect pushbuttons Operating temperature: -50 to +60°C	Flush Pushbuttons	OC-31
			Extended Pushbuttons	OC-32
Padlock Cover		Plastic hinged padlockable cover to protect pushbuttons or selector switches. (Not intended for E-Stops) Degree of protection: IP65	HW9Z-KL1	
Tab Terminal Adapter		Tab #250 (6.35 x 0.8mm): Single tab	TW-FA4	
Mounting Adaptor		Used to mount round HW series (except Jumbo Mushroom, unibody, and square units) into a larger panel cut-out. (includes both pieces)	22 to 30mm	HW9Z-A30
			22 to 25mm	HW9Z-A25
Replacement Safety Lever Lock		Used to prevent contact mounting lever from moving due to heavy vibration or panel maintenance.	HW9Z-LS	
Reset Rod for Contactors Overload		5" rod used with HW1B-M0.	HW9Z-RS-TK2141	
Replacement Operator Washer		Provided with operator. Insert between bezel and locking ring.	HWM-WASHER	
Replacement Locking Ring		Plastic locking nut comes with all HW operators & assemblies.	Standard (plastic)	HW9Z-LN
			Optional (metal)	HW9Z-LNM
Switch Cover (Square)		Used only with round or square flush pushbuttons.	HW9Z-K1 (spring return) HW9Z-K11 (maintained cover)	
Replacement Keys		Pair of Keys (#231)	HW9Z-SKP	
Replacement Lens		HW Illuminated Unibody Replacement Lens	HWLV-LENSR	

Switches & Pilot Devices

Signaling Lights

Relays & Sockets

Timers

Contactors

Terminal Blocks







Circuit Breakers

Switches & Pilot Devices



Signaling Lights

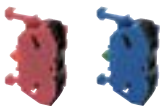
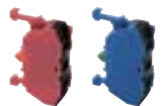

Relays & Sockets

Timers

Item	Appearance	Description/Usage	Part Number	
Replacement Jumbo Dome Lens		Polycarbonate Replacement Lens (If using yellow lens, use white LED.)	HW1A-P5Ⓞ Ⓞ = (A, G, R, S, W, Y)	
Replacement Jumbo LED Diffusing Lens			HW9Z-PP5C	
Replacement LED Lamps for HW Jumbo Dome		Replacement LED Lamp - applicable for jumbo pilot lights only	LSTD8-2Ⓞ Ⓞ = (A, G, R, S, W)	
Rubber Cover for Dual Pushbuttons		Clear Silicon rubber cover	HW9Z-D7D	
Barrier for Dual Pushbuttons		Plastic barrier. Used when mounting the HW7 units on 30mm horizontal centers, to prevent possible interconnections between adjoining terminals.	HW-VU1	
EMO Sticker		Emergency stop nameplate sticker	HW9Z-EMO-NP-TK2120	
Contact Blocks (with side entry)		These contacts are applicable for wires terminated by ring, fork, terminals, not recommended for bare wire connections.	1NC	1NO
			HW-U01 HW-U01-MAU HW-U01R HW-U01R-MAU (with side entry)	HW-U10 HW-U10-MAU HW-U10R HW-U10R-MAU (with side entry)
Contact Blocks (without side entry)		These contacts are applicable for wires terminated by ring, fork, or ferule terminals, and also bare wire connections.	HW-U01-F HW-U01-MAU-F HW-U01R-F HW-U01R-MAU-F (no side entry)	HW-U10-F HW-U10-MAU-F HW-U10R-F HW-U10R-MAU-F (no side entry)

E-Stop Shrouds

Style	Part Numbers	E-Stop Types	Applicable Standards
	HW9Z-KG1	40mm Mushroom Head	SEMI S2-0703, 12.5.1 Compliant
	HW9Z-KG2	40mm Mushroom Head	SEMI S2-0703, 12.5.1 & SEMATECH Compliant

Style	Part Numbers	E-Stop Types	Applicable Standards
	HW9Z-KG3	40mm Mushroom Head	SEMI S2 Compliant (Approved by TUV) ISO 13850
	HW9Z-KG4	40mm Mushroom Head	SEMI S2 Compliant (Approved by TUV) & SEMATECH ISO 13850

Contactors

Terminal Blocks

Circuit Breakers

Contact Assemblies

Standard Contact Assemblies

For use with Non-Illuminated Pushbuttons & E-Stops

Style	Contacts	Part Number
	1NO	HW-CBF10
	1NC	HW-CBF01
	1NO/1NC	HW-CBF11
	2NO	HW-CBF20
	2NC	HW-CBF02
	2NO/2NC	HW-CBF22



Gold contact option is available. Add suffix "MAU" to end of part number. For example, HW-CBF20 becomes HW-CBF20-MAU.

Full Voltage Contact Assemblies

For use with Illuminated Pushbuttons.

Style	Contacts	Part Number
	1NO	HW-FL10Q0
	2NO	HW-FL20Q0
	1NO/1NC	HW-FL11Q0
	1NC	HW-FL01Q0
	2NC	HW-FL02Q0



Order LED separately.

Transformer Contact Assemblies

For use with Illuminated Pushbuttons.

Style	Contacts	Part Number
	120V AC with LED	1NO HW-FL10H2-Ⓞ 2NO HW-FL20H2-Ⓞ 1NC HW-FL01H2-Ⓞ 1NO/1NC HW-FL11H2-Ⓞ
	240V AC with LED	1NO HW-FL10M4-Ⓞ 2NO HW-FL20M4-Ⓞ 1NC HW-FL01M4-Ⓞ 1NO/1NC HW-FL11M4-Ⓞ
	480V AC with LED	1NO HW-FL10T8-Ⓞ 2NO HW-FL20T8-Ⓞ 1NC HW-FL01T8-Ⓞ 1NO/1NC HW-FL11T8-Ⓞ



- In place of Ⓞ, specify the LED Color Code.
Ⓞ = A, G, R, S, or W
- 6V LED included.

Dimensions (mm)

Non-Illuminated Pushbuttons

Flush (HW1B-M1, -A1)

Extended (HW1B-M2, -A2)

ø29mm Mushroom (HW1B-M3 -A3)

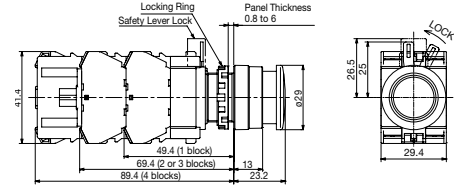
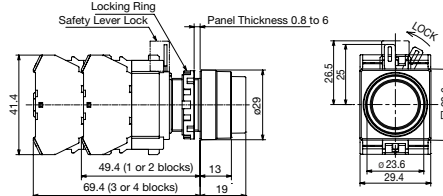
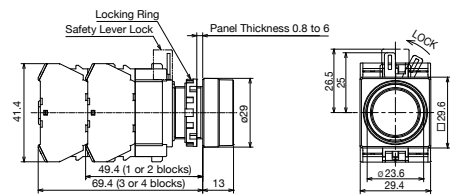

ø40mm Mushroom (HW1B-M4, -A4)

ø60mm Mushroom (HW1B-M5)

Square Flush (HW2B-M1, -A1)

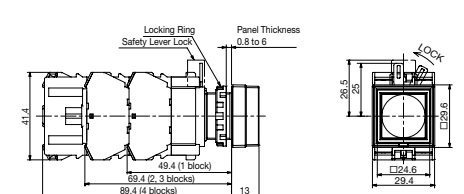
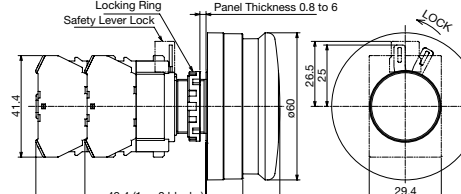
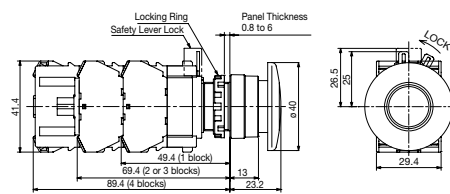

Square Extended (HW2B-M2, -A2)

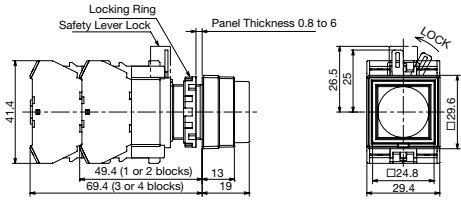

Contact Block (Bottom View)

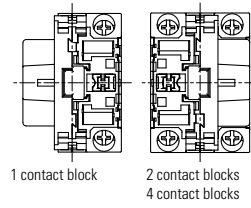

Terminal Wiring

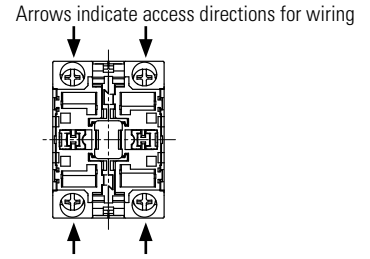

Operators

Flush (Round & Square)

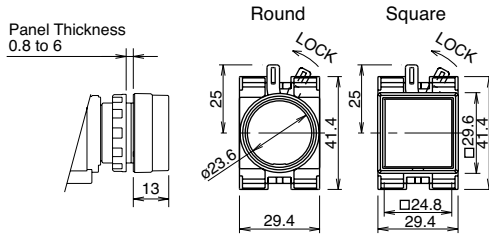

Extended

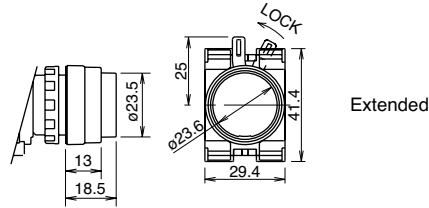

Extended with Full Shroud

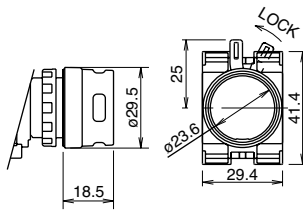

ø40mm Mushroom

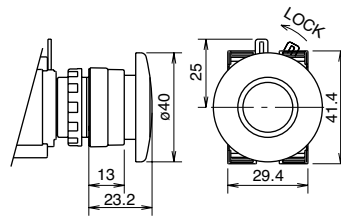

Dimensions (mm)

Emergency Stop Pushbuttons

ø29mm Head Pushlock Turn Reset (HW1B-V3)

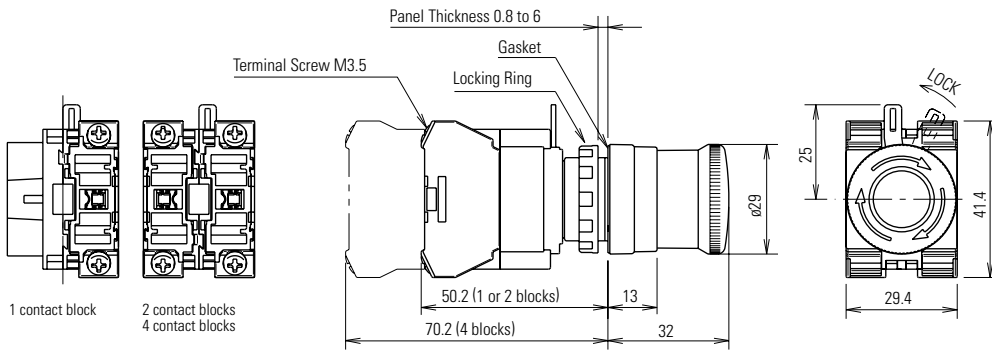

Dimensions (mm)

ø40mm Head Pushlock Turn Reset (HW1B-V4)

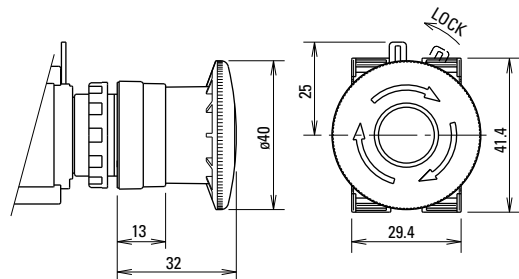

ø40mm Head EMO Pushlock Turn Reset (HW1B-V4)

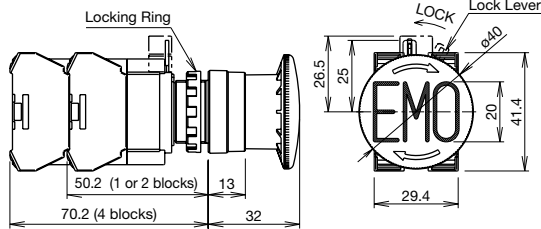

ø40mm Head Pushlock Key Reset (HW1B-X4)

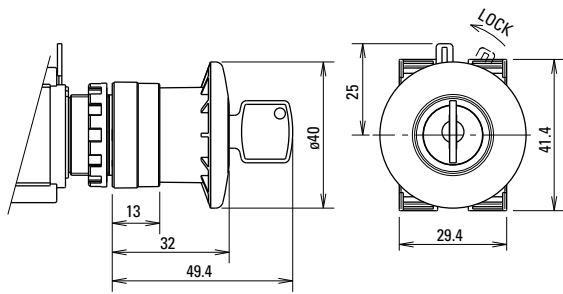

ø60mm Head Pushlock Turn Reset (HW1B-V5)

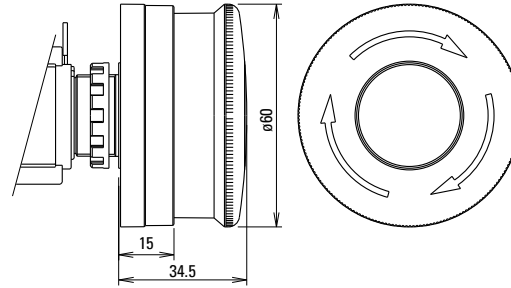

ø40mm Head Push-Pull (HW1B-Y2)

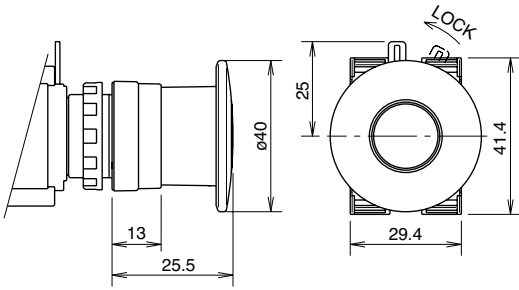

ø40mm Head Unibody Pushlock Turn Reset (HW1B-BV4)

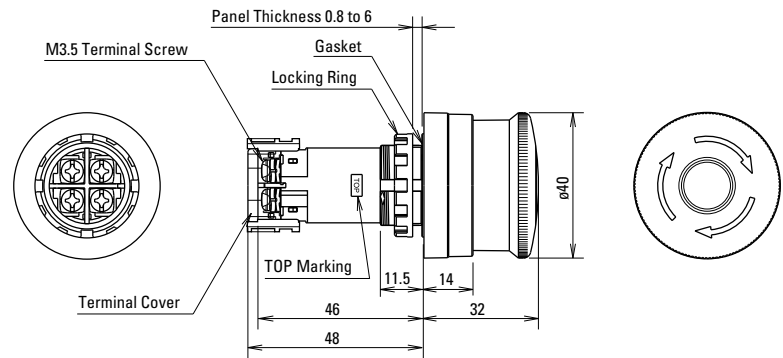

Illuminated E-Stop Pushbuttons (HW1E-LV4)

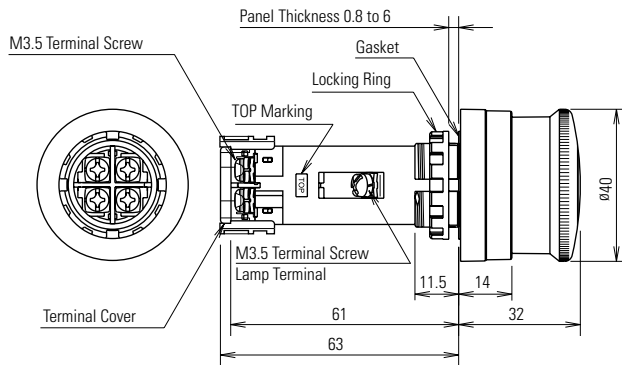

Mounting Hole

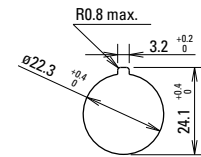

The minimum mounting centers shown below are applicable to E-Stop switches with one layer of contact blocks (two contact blocks). When two layers of contact blocks are mounted, determine the minimum mounting centers for ease of wiring.

Unit	Vertical Spacing	Horizontal Spacing
HW1B-V3	50 mm	50 mm
HW1B-V4		
HW1B-X4		
HW1B-Y2		
HW1B-V5	60 mm	60 mm

Terminal Arrangement (Bottom View)

HW1E-BV4

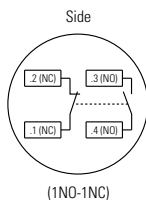

HW1E-LV4

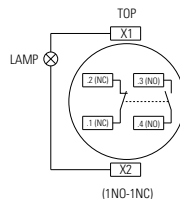

Emergency Stop Stations

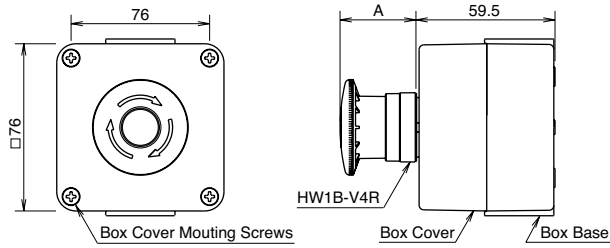

Operator	Dimension A (mm)
Pushlock Turn Reset	32
Pushlock Key Reset	32 (Key inserted: 49.4)
Push Pull	25.5

Mounting Hole Layout

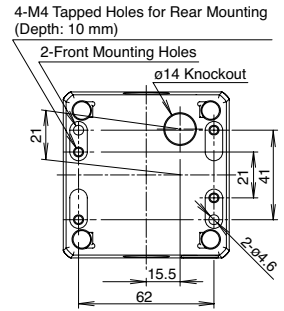

Dimensions (mm)

Pilot Lights

Round Flush Terminal screws: M3.5, integrated terminal cover

6, 12, 24V AC/DC, Without LED lamp

100/110V AC, 200/220V AC (240V AC maximum)

110V DC, 380V AC minimum

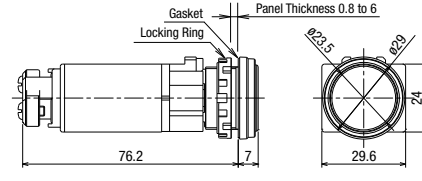
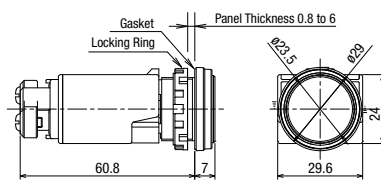
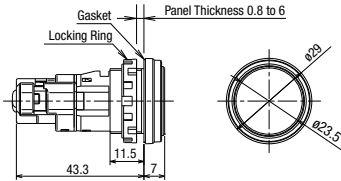

Dimensions (mm)

Extended Terminal screws: M3.5, integrated terminal cover

6, 12, 24V AC/DC, Without LED lamp

100/110V AC, 200/220V AC (240V AC maximum)

110V DC, 380V AC minimum

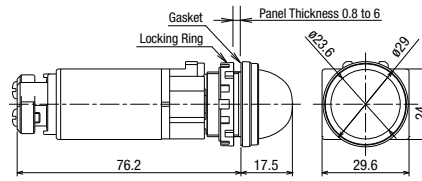
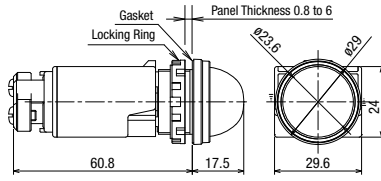
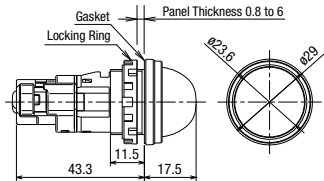

Square Flush Terminal screws: M3.5, integrated terminal cover

6, 12, 24V AC/DC, Without LED lamp

100/110V AC, 200/220V AC (240V AC maximum)

110V DC, 380V AC minimum

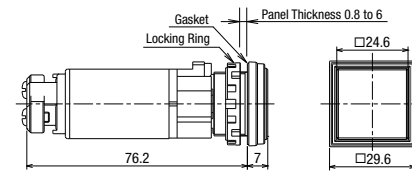
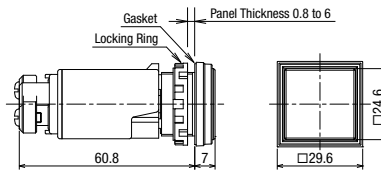
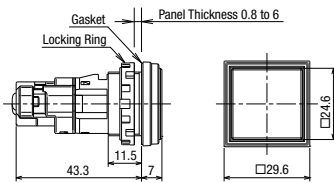

Jumbo Dome Pilot Light Terminal screws: M3.5, integrated terminal cover

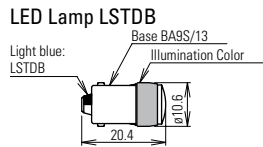
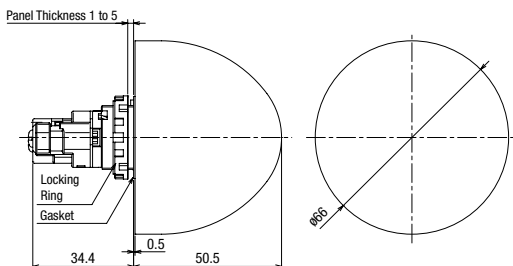

Mounting Hole Layout

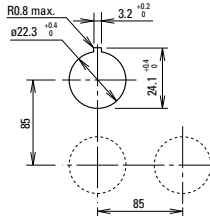

Mounting Hole Layout

Close mounting on 30mm centers
Degree of protection: IP65

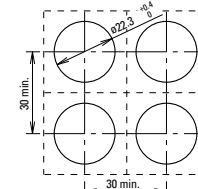

When mounting transformer or DC-DC converter type units on 30mm centers vertically and horizontally, keep the ambient temperature below 40°C.

Illuminated Pushbuttons

Full Voltage Models

1 Contact Block

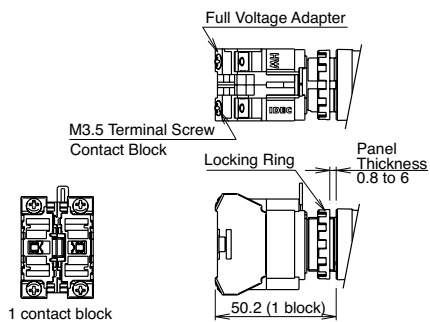

2 Contact Blocks

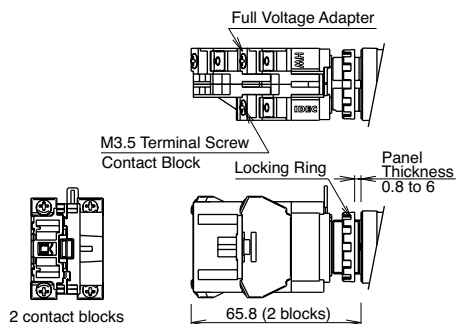

3 Contact Blocks

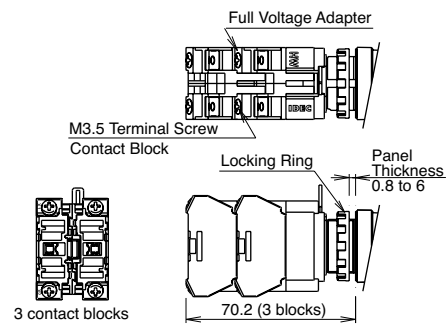

Illuminated Pushbuttons con't

4 Contact Blocks

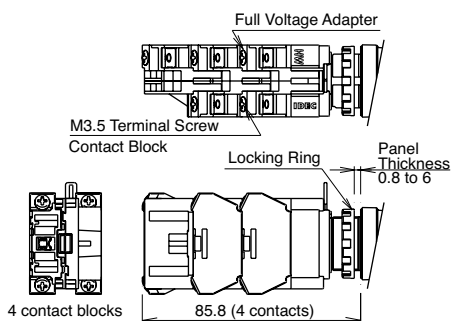

Terminal Wiring

Arrows indicate access directions for wiring.

Contact Block

Full Voltage Adaptor

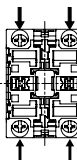

Transformer

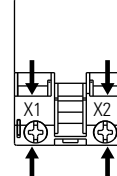

Dimensions (mm)

Transformer Models

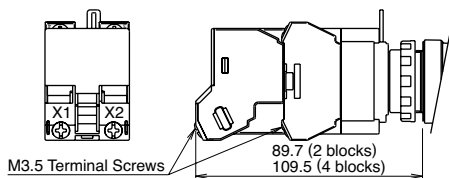

DC-DC Converter Models

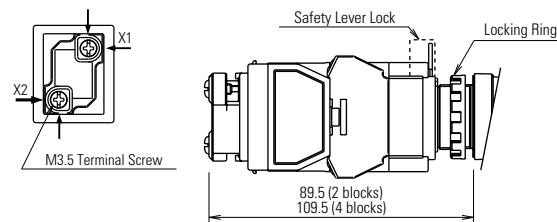

Non-Illuminated Selector & Key Switches

Knob Operator

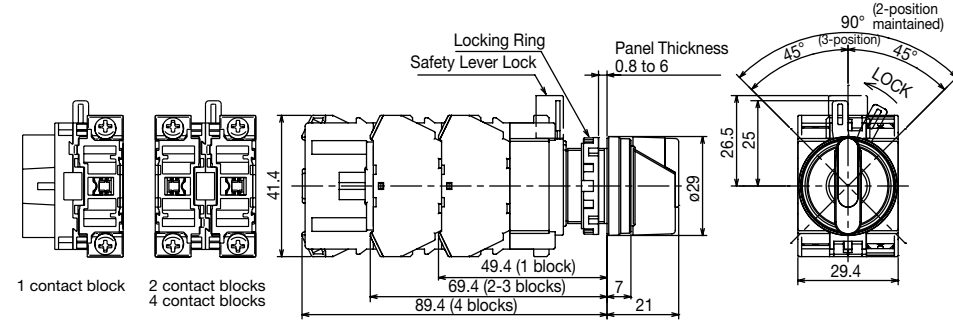

Dimensions (mm)

Terminal Wiring

Arrows indicate access directions for wiring.

Contact Block Full Voltage Adaptor

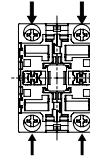

Key Operator

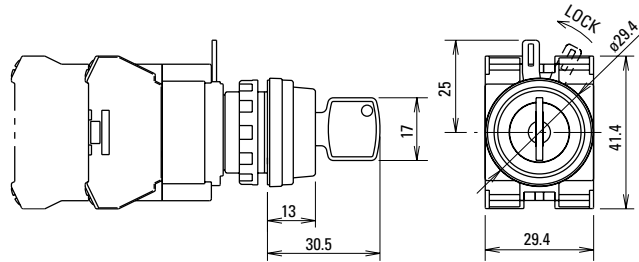

Transformer

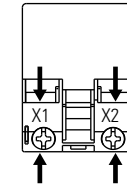

Illuminated Selector Switches

Full Voltage Model

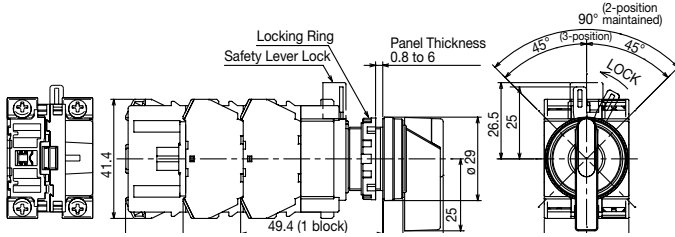

Transformer Model

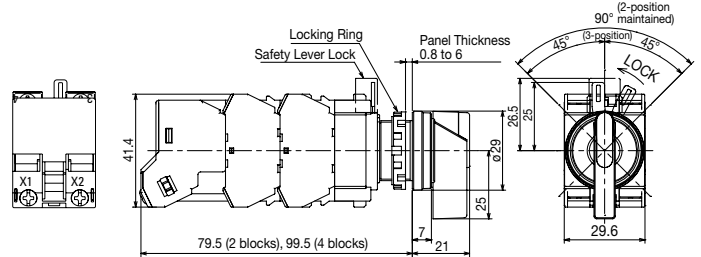

Dimensions (mm)

Dual Pushbutton

Without Pilot Light

Mounting Hole Layout

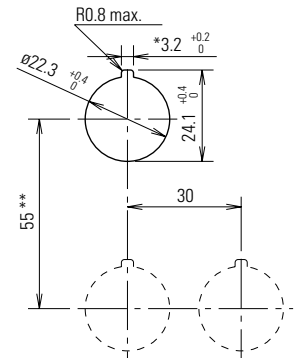

-The 3.2 mm recess is for preventing rotation and is not necessary when a nameplate or anti-rotation ring is not used.
 -When using the safety lever lock, determine the vertical spacing in consideration of convenience for installing and removing the safety lever lock.
 -Recommended vertical spacing: 100 mm
 -The minimum mounting centers are applicable to switches with one layer of contact blocks (two contact blocks). When two layers of contact blocks are mounted, determine the minimum mounting centers for ease of wiring.

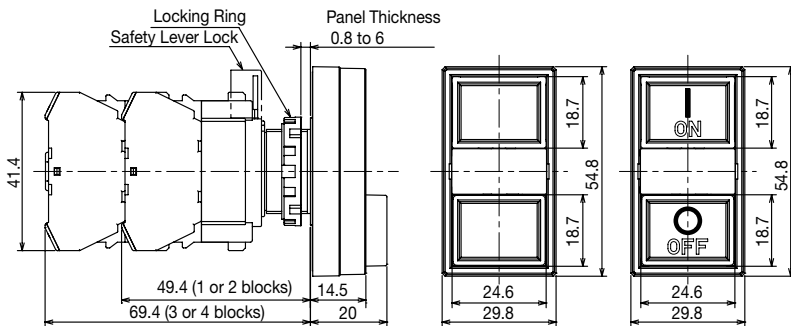
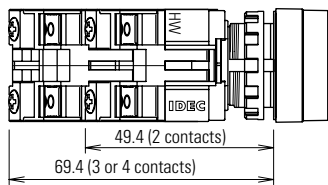

With Pilot Light

Full Voltage

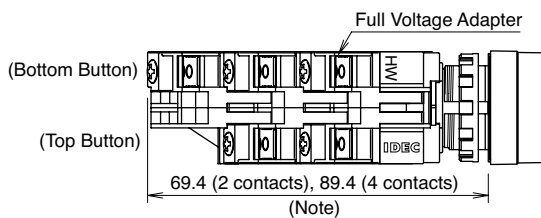

The depth of a 3-contact model depends on the combination of contact blocks at top and bottom pushbuttons.

Top Button	1 contact block	2 contact blocks
Bottom Button	2 contact blocks	1 contact block
Depth	89.4 mm	69.4 mm

Transformer (240V minimum)

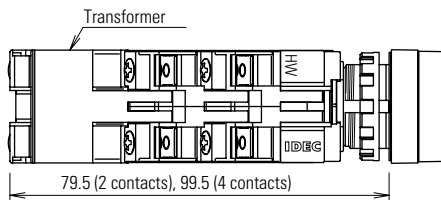

Transformer (480V)

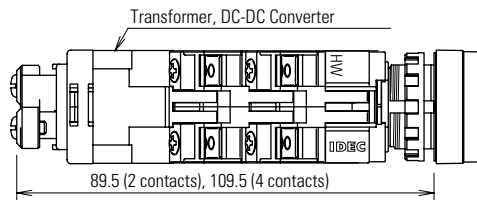

Monolever

Dimensions

Standard Lever

Interlocking Lever

All dimensions in mm.

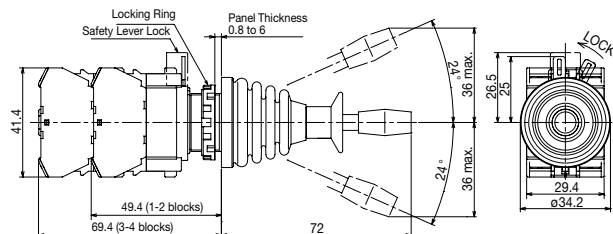
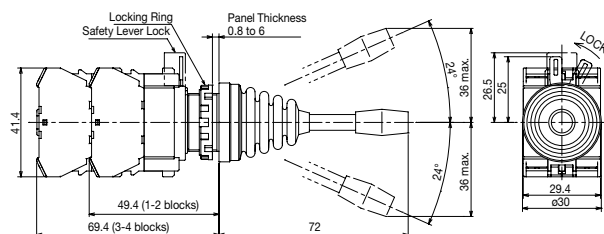

Terminal Screws M3.5 Integrated Terminal Cover

Accessory Dimensions

LW9Z-BM
Metallic Mounting Hole Plug

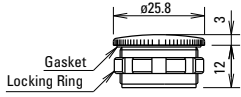

OB-31
Rubber Mounting Hole Plug

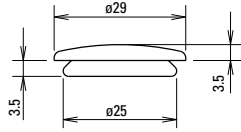

HW9Z-RL
Anti-Rotation Ring

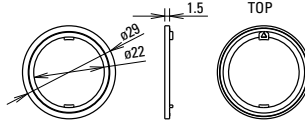

OR-55
Lamp/LED Removal Tool

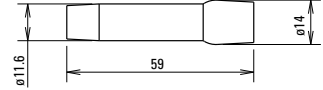

HW9Z-D7D
Dual Pushbutton Rubber Cover

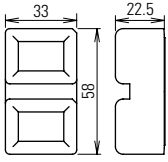

HW-VU1
Dual Pushbutton Barrier

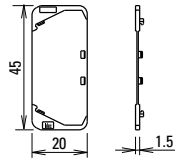

MW9Z-T1
Locking Ring Wrench

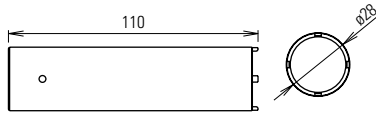

HW-VL1
Barrier

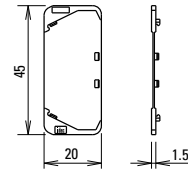

HW9Z-KL1
Padlock Cover

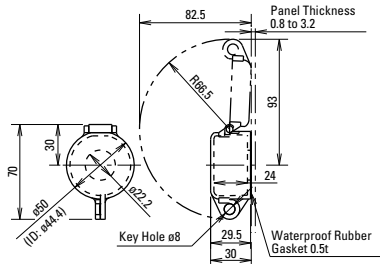

HWLS-TK1971
Safety Lever Lock

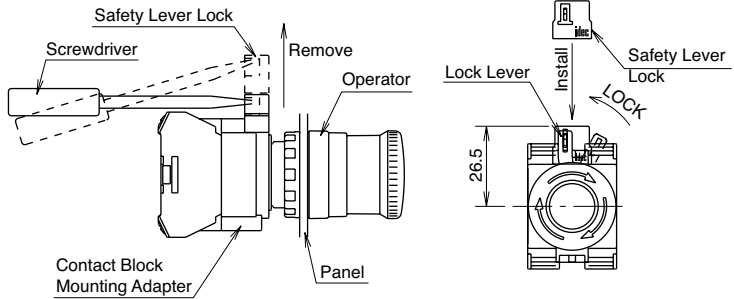

HW9Z-KG1

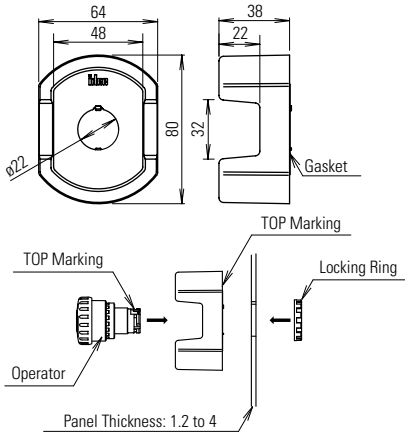

HW9Z-KG2

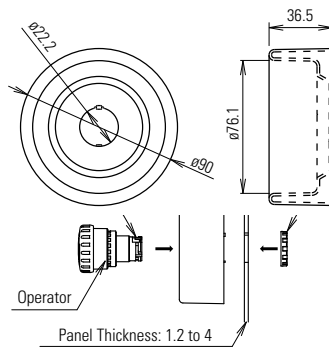

HW9Z-KG3

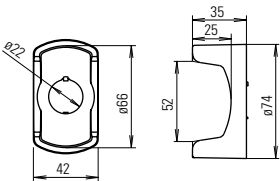

HW9Z-KG4

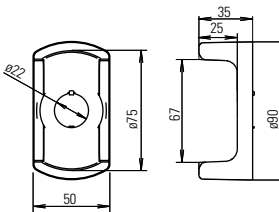

LSTD

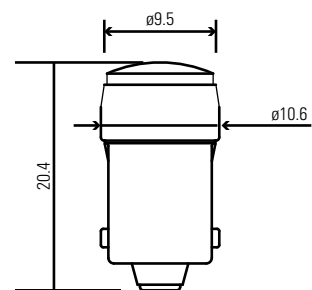

Specification Charts

INDUCTIVE

DC Voltages

Voltage V	24	48	110
Current A	4	2	1.1

AC Voltages

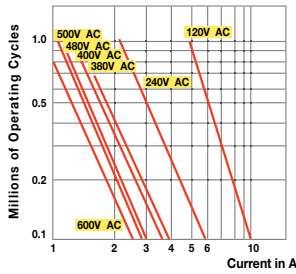

RESISTIVE

DC Voltages

Voltage V	24	48	110
Current A	8	4	2.2

AC Voltages

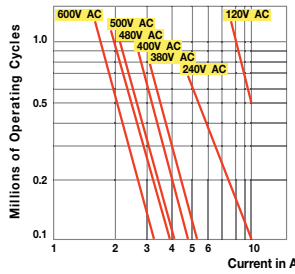

Conforming to IEC 947-5-1 Appendix C.
Utilization categories AC-15 and DC-13.
Operation rate: 1,800 op. hour
Load factor:
Inductive 0.4 ± 0.05
Resistive 0.9 ± 0.05

2 Position Selector Switches

	Contact	Mounting Position	Operator Position	
			Left	Right
HW1S-2T HW1K-2* HW1F-2	HW-U10-F (NO)	L	0	X
		R	0	X
	HW-U01-F (NC)	L	X	0
		R	X	0
	HW-U10R-F (NO-EM)	L	0	X
		R	0	X
	HW-U01R-F (NC-LB)	L	X	0
		R	X	0

Operator Truth Tables

3 Position Selector Switches con't

	Contact	Mounting Position	Operator Position		
			Left	Center	Right
HW1S-3JT HW1K-3J*	HW-U10-F (NO)	L	X	0	0
		R	0	0	X
	HW-U01-F (NC)	L	0	X	0
		R	0	X	0
	HW-U10R-F (NO-EM)	L	X	0	X
		R	X	0	X
	HW-U01R-F (NC-LB)	L	0	X	X
		R	X	X	0

3 Position Selector Switches

	Contact	Mounting Position	Operator Position		
			Left	Center	Right
HW1S-3T HW1K-3* HW1F-3	HW-U10-F (NO)	L	X	0	0
		R	0	0	X
	HW-U01-F (NC)	L	0	X	X
		R	X	X	0
	HW-U10R-F (NO-EM)	L	X	0	0
		R	0	0	X
	HW-U01R-F (NC-LB)	L	0	X	X
		R	X	X	0

4 Position Selector Switches

	Contact	Mounting Position	Operator Position			
			1	2	3	4
HW1S-4T	HW-U10-F (NO)	L	X	0	0	0
		R	0	0	0	X
	HW-U01-F (NC)	L	0	0	X	0
		R	0	X	0	0
	HW-U10R-F (NO-EM)	L	X	X	0	X
		R	X	0	X	X
	HW-U01R-F (NC-LB)	L	0	X	X	X
		R	X	X	X	0

5 Position Selector Switches

	Contact	Mounting Position	Operator Position				
			1	2	3	4	5
HW1S-5T	HW-U10-F (NO)	L	X	0	0	0	0
		R	0	0	0	0	X
	HW-U01-F (NC)	L	0	0	0	X	0
		R	0	X	0	0	0
	HW-U10R-F (NO-EM)	L	X	X	X	0	X
		R	X	0	X	X	X
	HW-U01R-F (NC-LB)	L	0	X	X	X	X
		R	X	X	X	X	0

1. Mounting position indicates which side of operator each contact should be mounted (as viewed from the front of the panel).
2. *For key removable code see page 661.

3. HW1S-3T is identified by white plungers on the operator.
4. HW1S-3ST is identified by red plungers on the operator.
5. HW1S-3JT is identified by black plungers on the operator.

HW Safety Precautions

Turn off power to HW series control units before starting installation, removal, wiring, maintenance, and inspection of the products. Failure to turn power off may cause electrical shocks or fire hazard.

To avoid the possibility of burning yourself, use the lamp holder tool when replacing lamps.

For wiring, use wires of a proper size to meet voltage and current requirements.

HW General Instructions

Panel Mounting

Remove the contact block assembly from the operator (for transformer type pilot lights, remove the transformer from the illumination unit). Remove the locking ring from the operator. Insert the operator into the panel cut-out from the front, tighten the locking ring from the back, then install the contact block assembly to the operator.

Removing and Installing the Contact Block Assembly

1. To remove the operator from the contact block, turn the locking lever in the direction of the arrow shown below. The operator can now be removed.
2. To reinstall, place the TOP markings on the operator and the contact block mounting adapter in the same direction, and insert the operator into the contact block mounting adapter. Then turn the locking lever in the opposite direction.

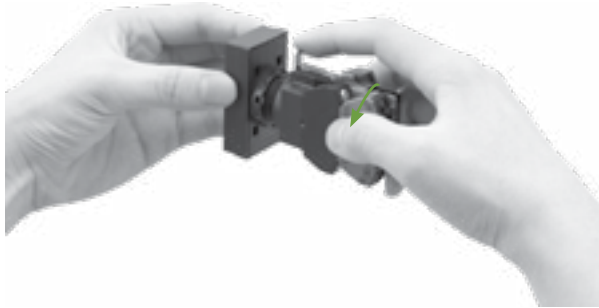

Safety Lever Lock

IDEC strongly recommends using the safety lever lock (HW9Z-LS, yellow) to prevent heavy vibration or maintenance personnel from unlocking the contact assembly.

1. HW series can be mounted vertically with a minimum spacing of 55 mm but spacing should be determined to ensure easy operation (recommended minimum spacing: 100 mm).
2. Mount the control unit onto the panel, lock the lever, and push in the safety lever lock to install.
3. When the spacing is narrower than the recommended value, with the lever unlocked, mount the safety lever lock and insert the contact unit to the operator. Then, lock the lever and strongly push in the safety lever lock to install.
4. To remove the safety lever lock, insert a flat screwdriver into the safety lever and push upwards.

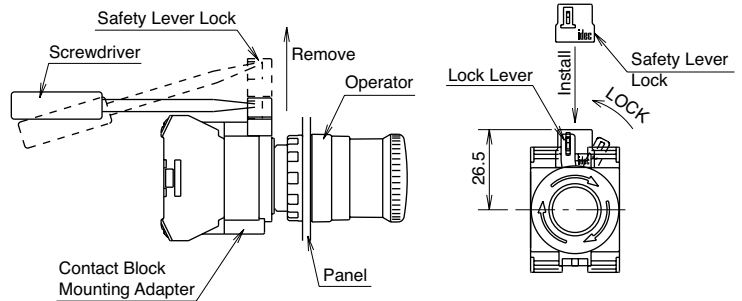

Notes for Panel Mounting

1. When mounting the operator onto a panel, use the optional locking ring wrench (MW9Z-T1) to tighten the locking ring. Tightening torque must not exceed 2.0 N·m. Do not use pliers. Excessive tightening will damage the locking ring.
2. For the contact blocks and transformers housing LED lamps, make sure not to press the lamps too hard, otherwise the lamp socket may be damaged.

Dual Pushbutton Instructions

Replacement of Lens

Removing

Remove the lens by inserting a screwdriver into the recess of the lens through the bezel.

Installing

Install the lens in the recess between the buttons by pressing against the bezel.

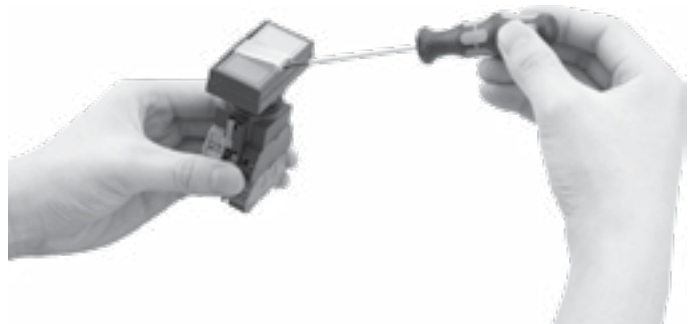

Dual Pushbuttons Instructions continued

Replacement of Lamps

LED lamps can be replaced by using the lamp holder tool (OR-55) from the front of the panel, or by removing the contact block assembly from the operator unit.

Removing the Lamps from the Front of the Panel

Removal

1. To remove, slip the lamp holder tool onto the lamp head lightly. Then push slightly, and turn the lamp holder tool counterclockwise.

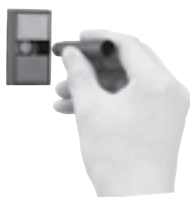

Installation

1. To install, insert the lamp head into the lamp holder tool, and hold the lamp as shown in the figure below.
2. Place the pins on the lamp base to the grooves in the lamp socket. Insert the lamp and turn it clockwise.

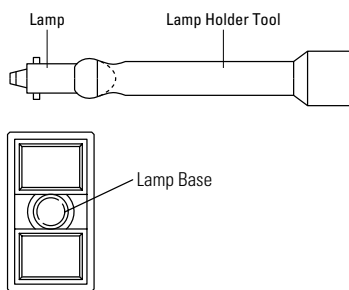

About Dual Pushbutton Switches

The dual pushbuttons cannot be removed or replaced!

Do not attempt to remove using a flat screwdriver or pincers, otherwise the dual pushbuttons may be damaged.

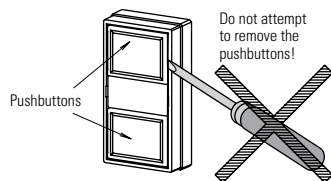

Narrow Mounting

When mounting the units closely in a horizontal row on 30mm centers, use optional barriers to prevent interconnection between adjoining terminals. The barriers can be attached simply by pressing them onto the sides of contact blocks.

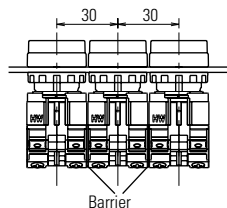
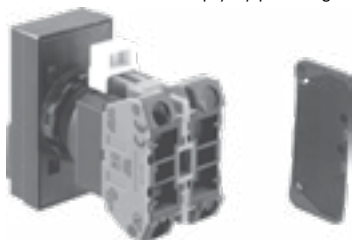

When mounting transformer type illuminated units closely in a horizontal row on 30mm centers, insert solid wires or stranded wires into inside of the terminal screw on the transformer (see figure on the right) to prevent short circuit between adjoining terminals.

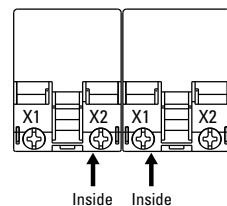

Installation of LED Illuminated Units

When using full voltage type LED illuminated units, provide protection against electrical noise, if necessary.

Applicable Wiring

The applicable wire size is 2 mm² maximum. (solid wire ø1.6mm² maximum) One or two wires can be connected.

Applicable Crimping Terminal

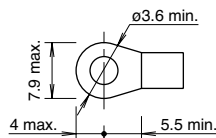

Be sure to use an insulation tube or cover on the crimping part of the crimping terminal to prevent electrical shocks.

Solid Wire



Note: When connecting wires to contact blocks or transformers in the direction shown below, keep the insulation stripping length 6.6 mm at the maximum.

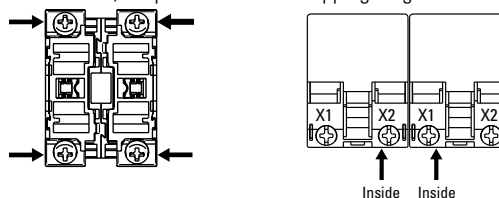

Installing the Rubber Boot

When using the HW7D pushbuttons in places where the pushbuttons are subjected to water splash or an excessive amount of dust, make sure to use the HW9Z-D7D rubber boot (IP65) which is ordered separately.

Notes for Installing the Rubber Boot

Remove the gasket from the operator, and install the rubber boot on the operator. Pull out the seals of the rubber boot and place them around the operator sleeve as shown. Make sure that the seals are not twisted or tucked inside and that the gasket does not remain, otherwise the normal waterproof and dustproof characteristics are not ensured.

1. Remove the gasket.
2. Install the rubber boot on the pushbuttons.
3. Rubber boot is installed.

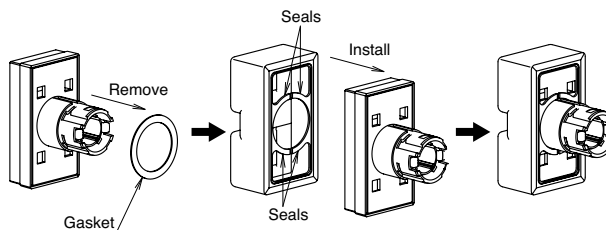

TW Series – 22mm NEMA Style Pushbuttons



Key features:

- TW NEMA Style Switches with snap-on contacts
- Corrosion resistant octagonal chrome plated locking bezel
- Snap-on 10A contact blocks
- LED illumination
- Slow make, double break, contacts
- Modular construction for maximum flexibility
- Type 4X and IP65 watertight/oiltight panel
- Available assembled or as sub-components
- Finger-Safe - Spring-Up
- Large M3.5 screw terminals with captive sems plate

IDEC has your 22mm switching needs covered.

Button styles include flush, extended, mushroom, or square and all bodies are crafted from fracture-resistant nylon.

All illuminated units feature two lens styles, one that maximizes light dispersion, the other accommodates direct lens engraving.

Contact mechanism allow for a wide current rating, 5mA to 10A, which reduces the need for various contact materials.

When looking for a 22mm switch that is durable, easy to use, and versatile, then IDEC's TW series is your solution.



UL Listed
File No. E68961



TUV Rheinland



CSA Approved
File No. LR21451



File No. DK95-01696



Certificate No.
2030010305027380



Switches & Pilot Devices

Signaling Lights





Relays & Sockets

Timers

Contactors

Terminal Blocks

Circuit Breakers

Conforming to Standards		EN60947-1, EN60947-5-1, VDE0660-200, UL508, CSA C22-2 No.14					
Approvals		 File No. E68961  File No. LR21451  Certificate No. 2030010305027380   Registration No: J9551802 (E-Stops) Registration No: J9551803 (All other switches) Registration No: J9551804 (Pilot Lights)					
Operating Temperature		Operation: -25 to +50°C (without freezing), Storage: -40 to +80°C (without freezing)					
Vibration Resistance		5 to 55Hz, 100m/sec ² (10g) conforming to IEC6068-2-6					
Shock Resistance		1000m/sec ² (100g) conforming to IEC6068-2-7					
Electric Shock Protection		Class 2 conforming to IEC60664-7					
Degree of Protection (conforming to IEC60529) (conforming to NEMA ICS6-110)		IP65 from front of the panel; (IP54 for key switches) IP20 (Type HW-U contact block) Type 1, 2, 3, 3R, 3S, 4, 4X, 5, 12, 13 (Type 1, 2, 3R, 5, 12, 13 for key switches)					
Mechanical Life		Momentary pushbuttons: 5,000,000 (1800 operations per hour) All other switches: 500,000					
Pollution Degree (conforming to IEC60947-1)		3					
Rated Operational Characteristics		AC-15: A600 or Ue = 250V, Ie = 3A (NO, NC, NO-EM, NC-LB) DC-13: P600 or Ue = 125V, Ie = 1.1A (NO, NC) DC-13: Q600 or Ue = 125V, Ie = 0.9A (NO-EM, NC-LB)					
Rated Insulation Voltage		600V					
Rated Switching Over-Voltage		Less than 4kV, conforming to IEC60947-1					
Rated Impulse Withstanding Voltage		4kV for contact circuit, 2.5kV for lamp circuit					
Rated Thermal Current		10 Amp					
Minimum Switching Capacity		5 mA at 3V AC/DC					
Contact Operation		Slow break NC or slow make NO, self-cleaning					
Recommended Terminal Torque		Unit		Wire	Number of Wires	Recommended Tightening Torque (Nm)	Terminal Screw
		HW-U Contact Block	Solid Wire	Crimping Terminal	2	1.0 to 1.3	M3.5
ø0.5 to 1.6 mm (AWG14 to 22)	2			1.0 to 1.3			
Stranded Wire	ø1.7 to 2.0 mm (AWG12)		1	1.2 to 1.3			
	0.3 to 2.0 mm ² (AWG14 to 22)		2	1.0 to 1.3			
Illuminated Unit (*1)	Solid Wire	Crimping Terminal	2	1.0 to 1.3	M3.5		
		ø0.5 to 1.6 mm (AWG14 to 22)	2	1.0 to 1.3			
Applicable Wire Size	Pilot Light	Solid Wire	ø0.5 to 1.6 mm (AWG14 to 22)	2	0.6 to 1.0 (M3.0)		
			Stranded Wire	ø0.3 to 2.0 mm (AWG14 to 22)	1.0 to 1.3 (M3.5)		
		 1. * refers to the lamp terminals of the illuminated push buttons and selector switches.					
External Short-Circuit Protection		10A 250V fuse conforming to IEC60269-1					
Applicable Wire Size		Minimum 1 x 22 AWG, max. 2 x 14 AWG or 1 x 12 AWG					
Contact Resistance		Initial contact resistance of 50mΩ or less					
Contact Gap		4mm (NO and NC), 2mm (NO-EM and NC-LB)					
Electrical Reliability		MTBF < 1 fault for 10 million operation cycles (3V DC, 5mA)					
Lamp Ratings		LEDs: 6V: 17mA max, 12/24V: 11mA max, 120/240V: 10mA max					
Horsepower Rating		1/4 HP @ 120V (single-phase, non-reversing motor); 1 HP @ 240V (3 phase, non-reversing motor)					
Contact Material		Silver					

Contact Ratings	Pushbuttons	Contact Block	Type HW-U
	Illuminated Pushbuttons	Rated Insulation Voltage	600V
	Selector Switches	Rated Continuous Current	10A
	Illuminated Selector Switches Pushbutton Selectors	Contact Ratings by Utilization Category IEC 60947-5-1	AC-15 (A600) DC-13 (P600)

		Contact Ratings by Utilization Category						
Operational Voltage			24V	48V	50V	110V	220V	440V
Operational Current	AC50/60Hz	AC-12 Control of resistive loads and solid state loads	10A	—	10A	10A	6A	2A
		AC-15 Control of electromagnetic loads (> 72VA)	10A	—	7A	5A	3A	1A
	DC	DC-12 Control of resistive loads and solid state loads	10A	5A	—	2.2A	1.1A	—
		DC-13 Control of electromagnets	5A	2A	—	1.1A	0.6A	—

Non-Illuminated Pushbuttons (Assembled)

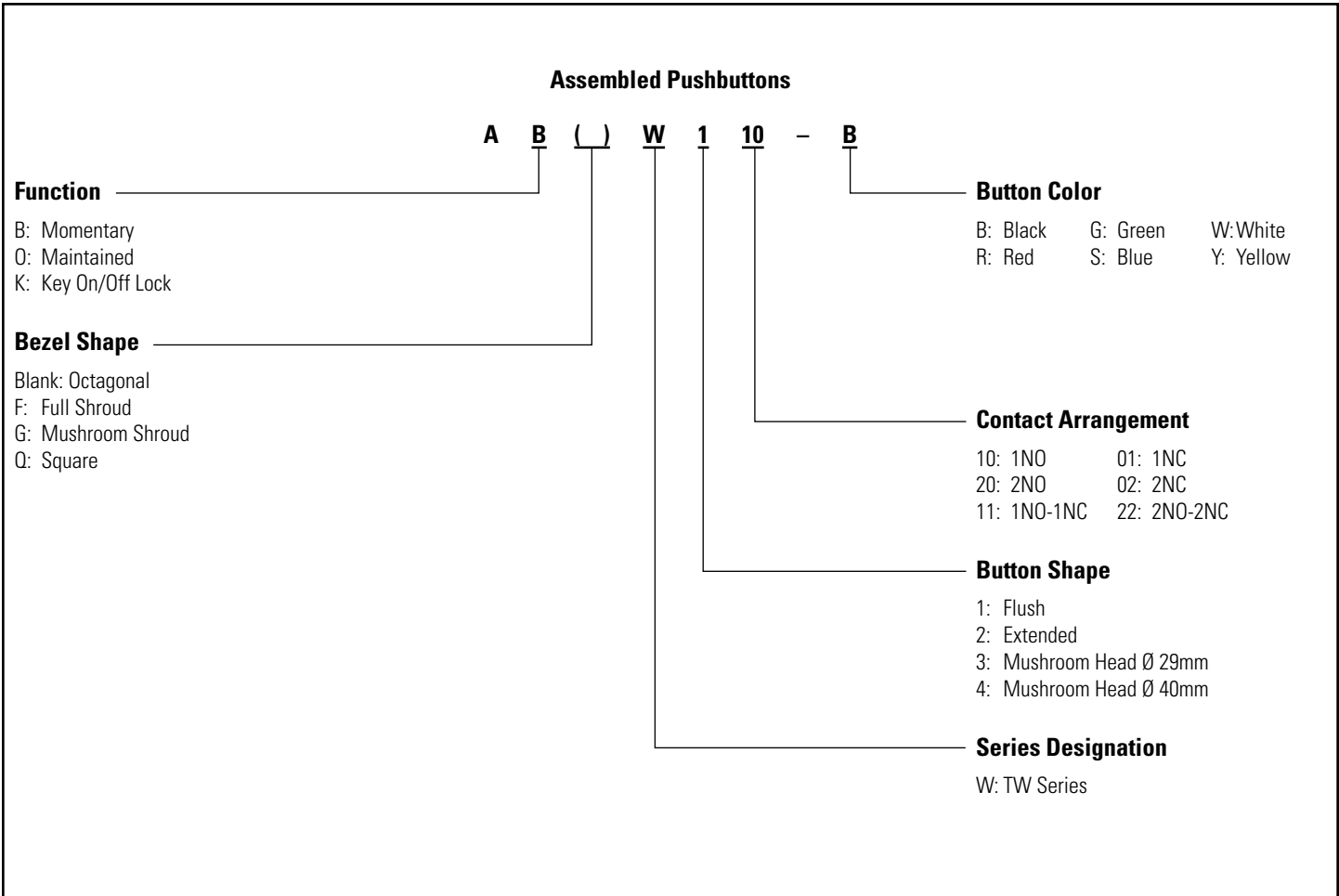
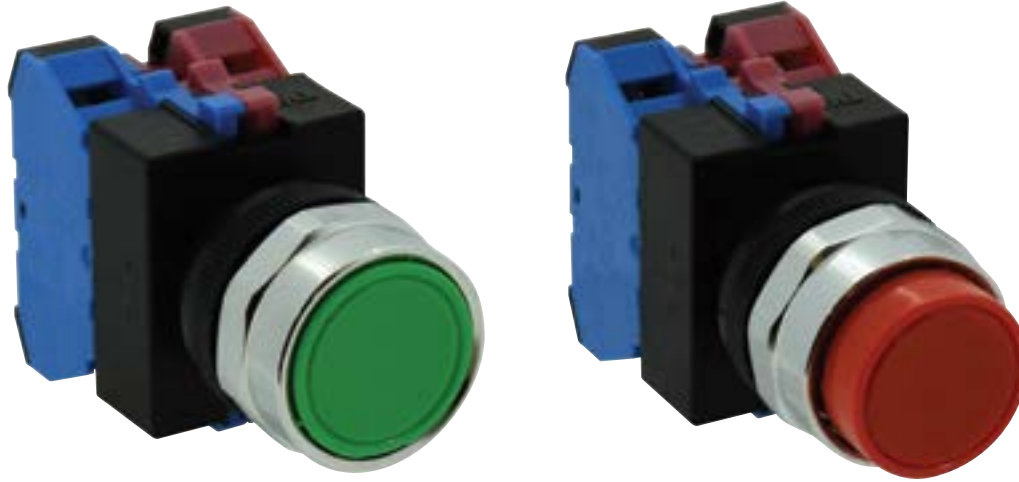

To be used for interpreting part numbers only, not for part number development.

Non-Illuminated Pushbuttons (Assembled) continued

Non-Illuminated Pushbuttons

Style	Contacts	Momentary Action	Maintained Action
Flush	1NO	ABW110-①	AOW110-①
	1NC	ABW101-①	AOW101-①
	1NO-1NC	ABW111-①	AOW111-①
	2NO	ABW120-①	AOW120-①
	2NC	ABW102-①	AOW102-①
Extended	1NO	ABW210-①	AOW210-①
	1NC	ABW201-①	AOW201-①
	1NO-1NC	ABW211-①	AOW211-①
	2NO	ABW220-①	AOW220-①
	2NC	ABW202-①	AOW202-①
Recessed	1NO	ABFW110-①	AOFW110-①
	1NC	ABFW101-①	AOFW101-①
	1NO-1NC	ABFW111-①	AOFW111-①
	2NO	ABFW120-①	AOFW120-①
	2NC	ABFW102-①	AOFW102-①
Extended with Full Shroud	1NO	ABFW210-①	AOFW210-①
	1NC	ABFW201-①	AOFW201-①
	1NO-1NC	ABFW211-①	AOFW211-①
	2NO	ABFW220-①	AOFW220-①
	2NC	ABFW202-①	AOFW202-①
Ø 29mm Mushroom Head	1NO	ABW310-①	AOW310-①
	1NC	ABW301-①	AOW301-①
	1NO-1NC	ABW311-①	AOW311-①
	2NO	ABW320-①	AOW320-①
	2NC	ABW302-①	AOW302-①
Ø 40mm Mushroom Head	1NO	ABW410-①	AOW410-①
	1NC	ABW401-①	AOW401-①
	1NO-1NC	ABW411-①	AOW411-①
	2NO	ABW420-①	AOW420-①
	2NC	ABW402-①	AOW402-①
Ø 40mm Mushroom Head with Full Shroud	1NO	ABGW410-①	AOGW410-①
	1NC	ABGW401-①	AOGW401-①
	1NO-1NC	ABGW411-①	AOGW411-①
	2NO	ABGW420-①	AOGW420-①
	2NC	ABGW402-①	AOGW402-①
Square Flush	1NO	ABQW110-①	AQW110-①
	1NC	ABQW101-①	AQW101-①
	1NO-1NC	ABQW111-①	AQW111-①
	2NO	ABQW120-①	AQW120-①
	2NC	ABQW102-①	AQW102-①
Square Extended	1NO	ABQW210-①	AQW210-①
	1NC	ABQW201-①	AQW201-①
	1NO-1NC	ABQW211-①	AQW211-①
	2NO	ABQW220-①	AQW220-①
	2NC	ABQW202-①	AQW202-①
Keylock Push On/Off	1NO	AKW210	—
	1NC	AKW201	
	1NO-1NC	AKW211	
	2NO	AKW220	
	2NC	AKW202	

① Button Color Codes

Color	Code
Black	B
Green	G
Red	R
Blue	S
Yellow	Y
White	W

- 1. In place of ①, specify the Button Color Code from table.
- 2. For sub-assembled part numbers, see next page.
- 3. For accessories, see page 726.
- 4. For dimensions, see page 728.
- 5. Keyed switches are supplied with two keys. All units are keyed alike.

Switches & Pilot Devices

Signaling Lights

Relays & Sockets

Timers

Contactors

Terminal Blocks

Circuit Breakers

Non-Illuminated Pushbuttons (Sub-Assembled)

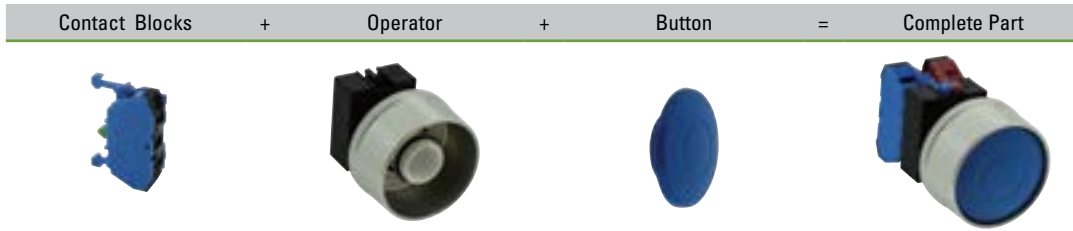

Operators

Style	Part Number	
	Momentary	Maintained
Round Flush/Extended 	ABW-100	AOW-100
Round with Full Shroud/Recessed 	ABFW-200	AOFW-200
Ø 40mm, Ø 29mm Mushroom Head 	ABW-300	AOW-300
Ø 40mm Mushroom Head with Full Shroud 	ABGW-400	AOGW-400
Square Flush/Extended 	ABQW-100	AQQW-100
Keylock Push On/Off 	—	AKW-200



Buttons

Style	Part Number
Round Flush 	ABW1B-①
Round Extended 	ABW2B-①
Ø 29mm Mushroom 	ABW3B-①
Ø 40mm Mushroom 	ABW4B-①
Square Flush 	ABQW1B-①
Square Extended 	ABQW2B-①

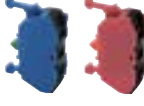

In place of ① specify the button color code from table

Contact Blocks

Style	Contacts	1NO	1NC
	Finger-Safe Spring-Up Terminal	HW-U10-F HW-U10R-F (early make)	HW-U01-F HW-U01R-F (late break)
	Dummy Block	HW-DB	



- Dummy blocks (no contacts) are used with an odd number of contact blocks.
- Use of early and late break contacts creates a make before break function

① Button Color Codes

Color	Code
Black	B
Green	G
Red	R
Blue	S
Yellow	Y
White	W

Stop Switches (Assembled)



 To be used for interpreting part numbers only, not for part number development.

Assembled Stop Switches

A V (L) W 4 (B) (99) 11 (D) - R - (24V)

<p>Function</p> <p>V: Pushlock Turn Reset Y: Push-Pull X: Pushlock Key Reset</p> <p>Illumination</p> <p>Blank: None L: Illuminated</p> <p>Series Designation</p> <p>W: TW Series</p> <p>Button/Lens Size</p> <p>3: 29mm Mushroom 4: 40mm Mushroom</p> <p>Lens Type (illuminated units only)</p> <p>Blank: Standard (ribbed) B: Engravable (smooth with insert)</p> <p>Illuminated Circuit (illuminated unit only)</p> <p>99: Full Voltage (LED determines voltage) 126: 120V AC Step Down Transformer 246: 240V AC Step Down Transformer 486: 480V AC Step Down Transformer</p>	<p>Lamp Voltage (full voltage illuminated units only)</p> <p>6V: 6V AC/DC 12V: 12V AC/DC 24V: 24V AC/DC 120V: 120V AC 240V: 240V AC</p> <p>Button/Lens Color</p> <p>A: Amber R: Red W: White G: Green S: Blue Y: Yellow B: Black</p> <p>Lamp Type (illuminated units only)</p> <p>D: LED</p> <p>Contact Arrangement</p> <p>10:1NO 01:1NC 20:2NO 02:2NC 11:1NO/1NC 22:2NO/2NC</p>
---	--

Stop Switches (Assembled), continued

Non-Illuminated Stop Switches

Style	Contacts	Part Number
 Ø 40mm Pushlock Turn Reset*	1NO	AVW410-R*
	1NC	AVW401-R*
	1NO-1NC	AVW411-R*
	2NO	AVW420-R*
	2NC	AVW402-R*
 Ø 29mm Pushlock Turn Reset*	1NO	AVW310-R*
	1NC	AVW301-R*
	1NO-1NC	AVW311-R*
	2NO	AVW320-R*
	2NC	AVW302-R*
 Ø 40mm Push-Pull	1NO	AYW410-①
	1NC	AYW401-①
	1NO-1NC	AYW411-①
	2NO	AYW420-①
	2NC	AYW402-①
 Ø 40mm Pushlock Key Reset*	1NO	AXW410- R*
	1NC	AXW401- R*
	1NO-1NC	AXW411- R*
	2NO	AXW420- R*
	2NC	AXW402- R*

① Button Color Codes

Color	Code
Black	B
Green	G
Red	R
Blue	S
White	W
Yellow	Y

② LED/Lens Color Codes

Color	Code
Amber	A
Green	G
Red	R
Blue	S
White	W

③ Full Voltage Codes

Voltage	Code
6V AC/DC	6V
12V AC/DC	12V
24V AC/DC	24V
120V AC	120V
240V AC	240V



④ Transformer Voltage Codes

Voltage	Code
120VAC	126
240VAC	246
480VAC	486

 Transformers step down to 6V.

- *Available in Red only.
- In place of ①, specify the Button Color Code from table.
- For sub-assembled part numbers, see next page.
- For accessories, see page 726.
- For dimensions, see page 728.

Illuminated Stop Switches

Style	Type	Contacts	Part Number
 Ø 40mm Pushlock Turn Reset Type	Transformer	1NO-1NC	AVLW4 ④ 11D-R*
		2NO	AVLW4 ④ 20D-R*
		2NC	AVLW4 ④ 02D-R*
	Full Voltage	1NO-1NC	AVLW49911D-R*-③
 Ø 29mm Pushlock Turn Reset	Transformer	1NO-1NC	AVLW3④11D-R*
		2NO	AVLW3④20D-R*
		2NC	AVLW3④02D-R*
	Full Voltage	1NO-1NC	AVLW39911D-R*-③
		2NO	AVLW39920D-R*-③
		2NC	AVLW39902D-R*-③
 Ø 40mm Push-Pull	Transformer	1NO-1NC	AYLW4 ④ 11D-②
		2NO	AYLW4 ④ 20D-②
		2NC	AYLW4 ④ 02D-②
	Full Voltage	1NO-1NC	AYLW49911D-②-③
		2NO	AYLW49920D-②-③
		2NC	AYLW49902D-②-③

- *Available in red only.
- In place of ②, specify the Lens Color Code (see table above).
- In place of ③, specify the Full Voltage Code (lamp voltage) (see table above).
- In place of ④, specify the Transformer Voltage Code (see table above).
- For sub-assembly part numbers, see next page.
- For accessories, see page 726.
- For dimensions, see page 728.

Stop Switches (Sub-Assembled)

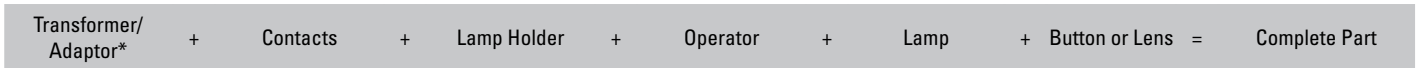



*Not applicable for full voltage units

Operators

Style	Part Number	
	Non-Illuminated	Illuminated
Ø 29/Ø 40mm Pushlock Turn Reset 	AVW-300	AVLW3-0600
Ø 40mm Push-Pull 	AYW-400	AYLW4-0600
Ø 40mm Pushlock Key Reset 	AXW-300	—

Buttons

Style	Part Number
Ø 40mm Pushlock Turn Reset 	AVW4B-R*
Ø 29mm Pushlock Turn Reset 	AVW3B-R*
Ø 40mm Push-Pull 	AYW4B-⊙
Ø 40mm Pushlock Key Reset 	AXW4B-R*

- 1. *Available in Red only
- 2. In place of ⊙, specify the button color code from table.

Lamps

Style	Voltage	Part Number
LED 	6V AC/DC	LSTD-6⊙
	12V AC/DC	LSTD-1⊙
	24V AC/DC	LSTD-2⊙
	120V AC	LSTD-H2⊙
	240V AC	LSTD-M4⊙

- 1. In place of ⊙, specify the LED color code.
- 2. The LED contains a current-limiting resistor and a protection diode.

① Button Color Codes

Color	Code
Black	B
Green	G
Red	R
Blue	S
White	W
Yellow	Y

② LED/Lens Color Codes

Color	Code
Amber	A
Green	G
Red	R
Blue	S
White	W

Illuminated Stop Switches (Sub-Assembled) continued

Lenses

Style	Part Number	
	Standard	Engravable
Ø 29mm Head Pushlock Turn Reset 	AVLW3LU-R*	AVLW3BLU-R*
Ø 40mm Head Pushlock Turn Reset 	AVLW4LU-R*	AVLW4BLU-R*
Ø 40mm Head Push Pull 	AYLW4LU-Ⓢ	AYLW4BLU-Ⓢ

- 1. In place of Ⓢ, specify the lens color code from table on previous page.
- 2. *Available only in red
- 3. Standard lenses have ribbed pattern, Engravable lenses are smooth and include an engravable insert.

Lamp Circuit Components



Style	Application	Part Number
Long Lamp Holder 	Used with Full-size Transformer and two contact blocks	TW-LH2
Lead Holder 	Used with TW-LH2 holder when using four contact blocks and transformer	HW-LH3

Transformers/Full Voltage Modules

Style	Description	Part Number
Full Size Transformer 	120V AC	TW-F126B
	240V AC	TW-F246B
	480V AC	TW-F486B
Dummy Block with Full Voltage Adaptor 	For use with odd number of contacts. Finger-Safe	HW-DA1FBN
Full Voltage Adaptor 	For use with even number of contacts. Finger-Safe	TW-DA1FB

 All Transformers step down to 6V (use 6V LED).

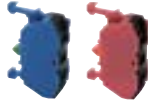
Contact Blocks

Style	Contacts	1NO	1NC
	Finger-Safe Spring-Up Terminal	HW-U10-F	HW-U01-F
		HW-U10R-F (early make)	HW-U01R-F (late break)
	Dummy Block	HW-DB	

- 1. Dummy blocks (no contacts) are used with an odd number of contact blocks.
- 2. Use of early and late break contacts creates a make before break function

Switches & Pilot Devices

Signaling Lights

Relays & Sockets

Timers

Contactors

Terminal Blocks

Circuit Breakers

Pilot Lights (Assembled)



Assembled Pilot Lights

A P (Q) W 1 (B) (99) (D) - R - (24V)

Function

P: Pilot Light

Bezel Shape

Blank: Octagonal (round lenses)
Q: Square

Series Designation

W: TW Series

Lens Shape

1: Flat
2: Dome

Lens Type

Blank: Standard (ribbed)
B: Engravable (smooth with insert included)

Illumination Circuit

- 99: Full Voltage (lamp determines voltage)
- 126: 120V AC Step Down Transformer
- 246: 240V AC Step Down Transformer
- 486: 480V AC Step Down Transformer

Lamp Voltage

(Full Voltage Units Only)

- 6V: 6V AC/DC
- 12V: 12V AC/DC
- 24V: 24V AC/DC
- 120V: 120V AC
- 240V: 240V AC

Lens Color Code

- A: Amber
- G: Green
- R: Red
- S: Blue
- W: White
- Y: Yellow

Lamp

D: LED



1. Use only when interpreting part numbers. Do not use for developing part numbers.
2. All transformers step down to 6V.

Pilot Lights (Assembled) continued

Assembled Pilot Lights

Style	Type	Voltage	Part Number
Round Flat	Transformer	120VAC 240VAC 480VAC	APW1126D-② APW1246D-② APW1486D-②
	Full Voltage	—	APW199D-②-③
Dome	Transformer	120VAC 240VAC 480VAC	APW2126D-② APW2246D-② APW2486D-②
	Full Voltage	—	APW299D-②-③
Square Flat	Transformer	120VAC 240VAC 480VAC	APQW1B126D-② APQW1B246D-② APQW1B486D-②
	Full Voltage	—	APQW1B99D-②-③

② Lens Color Codes

Color	Code
Amber	A
Green	G
Red	R
Blue	S
White	W
Yellow	Y

③ Full Voltage Codes

Voltage	Code
6V AC/DC	6V
12V AC/DC	12V
24V AC/DC	24V
120V AC	120V
240V AC	240V

- 1. In place of ②, specify the Lens Color Code from table below.
- 2. In place of ③, specify the Full Voltage Code from table below.
- 3. For accessories, see page 726.
- 4. For dimensions, see page 728.
- 5. For sub-assembly part numbers, see next page.
- 6. Yellow pilot light comes with white LED.

Pilot Lights (Sub-Assembled)



* Transformer not required for full voltage units.

Operators

Style	Part Number
Round Dome/Flat	APW-199
	
Square	UPQW-199
	



Same operator is used for full voltage as for transformer completed units.

Lamps

Style	Voltage	Part Number
LED	6V AC/DC	LSTD-6Ⓢ
	12V AC/DC	LSTD-1Ⓢ
	24V AC/DC	LSTD-2Ⓢ
	120V AC	LSTD-H2Ⓢ
	240V AC	LSTD-M4Ⓢ



- In place of Ⓢ, specify the LED color code.
- The LED contains a current-limiting resistor and a protection diode.
- Yellow LED not available. Use white LED.

Ⓢ LED/Lens Color Codes

Color	Code
Amber	A
Green	G
Red	R
Blue	S
White	W
Yellow	Y



If clear lens is desired, use white marking lens and remove engraving insert

Transformers

Style	Description	Part Number
	120V AC	TW-F126B
	Finger-Safe 240V AC	TW-F246B
	480V AC	TW-F486B



All Transformers step down to 6V (use 6V LED).

Lenses

Style	Part Number	
	Standard	Engravable
Dome	APW2LU-Ⓢ	—
Round Flat	APW1LU-Ⓢ	APW1BLU-Ⓢ
		
Square Flat	—	APQW1BLU-Ⓢ
		



- In place of Ⓢ, specify the Lens Color Code from table.
- Standard lenses have a ribbed lens to enhance light dispersion. Marking lenses are smooth and include an engraving insert.

Illuminated Pushbuttons (Assembled)



Assembled Illuminated Pushbuttons

A L (F) W 2 (B) 99 11 (D) - R - (24V)

Function

L: Momentary Action
OL: Maintained Action

Bezel Shape

Blank: Octagonal (round lenses)
F: Full Shroud (round lenses)
O: Square

Series Designation

W: TW series

Lens Shape/Size

2: Standard Extended (round or square)
3: 29mm Mushroom
4: 40mm Mushroom

Lens Type

Blank: Standard (ribbed)
B: Engravable (smooth with insert)

Illumination Circuit

99: Full Voltage (lamp determines voltage)
126: 120V AC Step Down Transformer
246: 240V AC Step Down Transformer
486: 480V AC Step Down Transformer

Lamp Voltage

(Full Voltage Units Only)

6V: 6V AC/DC
12V: 12V AC/DC
24V: 24V AC/DC
120V: 120V AC
240V: 240V AC

Lens Code

A: Amber
G: Green
R: Red
S: Blue
W: White
Y: Yellow

Lamp Type

D: LED Lamp

Contact Arrangement

10: 1NO	01: 1NC
20: 2NO	02: 2NC
11: 1NO-1NC	22: 2NO-2NC



1. Use only when interpreting part numbers. Do not use for developing part numbers.
2. Transformers step down to 6V.

Illuminated Pushbuttons (Assembled)

Illuminated Pushbuttons

Style	Contacts	Part Number		
		Momentary	Maintained	
Extended Lens 	Transformer	1NO-1NC 2NO 2NC	ALW2 ④ 11D-② ALW2 ④ 20D-② ALW2 ④ 02D-②	AOLW2 ④ 11D-② AOLW2 ④ 20D-② AOLW2 ④ 02D-②
	Full Voltage	1NO-1NC 2NO 2NC	ALW29911D-②-③ ALW29920D-②-③ ALW29902D-②-③	AOLW29911D-②-③ AOLW29920D-②-③ AOLW29902D-②-③
Extended Lens with Full Shroud 	Transformer	1NO-1NC 2NO 2NC	ALFW2 ④ 11D-② ALFW2 ④ 20D-② ALFW2 ④ 02D-②	AOLFW2 ④ 11D-② AOLFW2 ④ 20D-② AOLFW2 ④ 02D-②
	Full Voltage	1NO-1NC 2NO 2NC	ALFW29911D-②-③ ALFW29920D-②-③ ALFW29902D-②-③	AOLFW29911D-②-③ AOLFW29920D-②-③ AOLFW29902D-②-③
ø29mm Mushroom Button 	Transformer	1NO-1NC 2NO 2NC	ALW3 ④ 11D-② ALW3 ④ 20D-② ALW3 ④ 02D-②	AOLW3 ④ 11D-② AOLW3 ④ 20D-② AOLW3 ④ 02D-②
	Full Voltage	1NO-1NC 2NO 2NC	ALW39911D-②-③ ALW39920D-②-③ ALW39902D-②-③	AOLW39911D-②-③ AOLW39920D-②-③ AOLW39902D-②-③
ø40mm Mushroom Button 	Transformer	1NO-1NC 2NO 2NC	ALW4 ④ 11D-② ALW4 ④ 20D-② ALW4 ④ 02D-②	AOLW4 ④ 11D-② AOLW4 ④ 20D-② AOLW4 ④ 02D-②
	Full Voltage	1NO-1NC 2NO 2NC	ALW49911D-②-③ ALW49920D-②-③ ALW49902D-②-③	AOLW49911D-②-③ AOLW49920D-②-③ AOLW49902D-②-③
Square Extended 	Transformer	1NO-1NC 2NO 2NC	ALQW2B ④ 11D-② ALQW2B ④ 20D-② ALQW2B ④ 02D-②	AOLQW2B ④ 11D-② AOLQW2B ④ 20D-② AOLQW2B ④ 02D-②
	Full Voltage	1NO-1NC 2NO 2NC	ALQW2B9911D-②-③ ALQW2B9920D-②-③ ALQW2B9902D-②-③	AOLQW2B9911D-②-③ AOLQW2B9920D-②-③ AOLQW2B9902D-②-③

② LED/Lens Color Codes

Color	Code
Amber	A
Green	G
Red	R
Blue	S
White	W
Yellow	Y

- 1. Mushroom lenses not available in yellow.
- 2. Yellow pushbutton comes with white LED.

③ Full Voltage Codes

Voltage	Code
6V AC/DC	6V
12V AC/DC	12V
24V AC/DC	24V
120V AC	120V
240V AC	240V

④ Transformer Voltage Codes

Voltage	Code
120VAC	126
240VAC	246
480VAC	486

- Transformers step down to 6V (use 6V LED).

- 1. In place of ②, specify the Lens Color Code (see table). Mushroom lenses not available in yellow.
- 2. In place of ③, specify the Full Voltage Code (lamp voltage) (see table).
- 3. In place of ④, specify the Transformer Voltage Code (see table).
- 4. For sub-assembly part numbers, see next page.
- 5. For accessories, see page 726.
- 6. For dimensions, see page 728.
- 7. Light is independent of switch position.
- 8. Yellow pushbutton comes with white LED.

Illuminated Pushbuttons (Sub-Assembled)



*Not applicable for full voltage units

Operators

Style	Part Number	
	Momentary	Maintained
Extended	ALW-0600	AOLW-0600
Extended with Full Shroud	ALFW-0600	AOLFW-0600
ø29mm/ø40mm Mushroom	ALW3-0600	AOLW3-0600
Square/Extended	ALQW-2B0600	AOLQW-2B0600

Lamps

Style	Voltage	Part Number
LED	6V AC/DC	LSTD-6Ⓢ
	12V AC/DC	LSTD-1Ⓢ
	24V AC/DC	LSTD-2Ⓢ
	120V AC	LSTD-H2Ⓢ
	240V AC	LSTD-M4Ⓢ

- 1. In place of Ⓢ, specify the LED color code.
- 2. The LED contains a current-limiting resistor and a protection diode.

Lamp Circuit Components

Style	Application	Part Number
Long Lamp Holder	Used with Full-size Transformer and two contact blocks	TW-LH2
Lead Holder	Used with TW-LH2 holder when using four contact blocks and transformer	HW-LH3

Lenses

Style	Part Number	
	Standard	Engravable
Round Extended	ALW2LU-Ⓢ	ALW2BLU-Ⓢ
ø 29mm Mushroom Head*	ALW3LU-Ⓢ	ALW3BLU-Ⓢ
ø 40mm Mushroom Head*	ALW4LU-Ⓢ	ALW4BLU-Ⓢ
Square Extended	—	ALQW2BLU-Ⓢ

Ⓢ LED/Lens Color Codes



Color	Code	Color	Code
Amber	A	Blue	S
Green	G	White	PW
Red	R	Yellow	Y

Yellow LED not available. Use white LED.

- 1. In place of Ⓢ, specify the lens color code from table on the bottom right.
- 2. *Mushroom lens not available in yellow.
- 3. Standard lenses have ribbed pattern, Engravable lenses are smooth and include an engravable insert.

Illuminated Pushbuttons (Sub-Assembled) continued

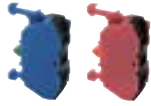
Contact Blocks

Style	Contacts	1NO	1NC
	Finger-Safe Spring-Up Terminal	HW-U10-F	HW-U01-F
		HW-U10R-F (early make)	HW-U01R-F (late break)
	Dummy Block	HW-DB	

- 1. Dummy blocks (no contacts) are used with an odd number of contact blocks.
- 2. Use of early and late break contacts creates a make before break function

Transformers/Full Voltage Modules

Style	Description	Part Number
	Full Size Transformer	
	Finger-Safe 120V AC	TW-F126B
	Finger-Safe 240V AC	TW-F246B
	Finger-Safe 480V AC	TW-F486B
Dummy Block with Full Voltage Adaptor	 For use with odd number of contacts.	Finger-Safe HW-DA1FBN
Full Voltage Adaptor	 For use with even number of contacts.	Finger-Safe TW-DA1FB

 All Transformers step down to 6V (use 6V LED).

Non-Illuminated Selector Switches (Assembled)



Assembled Selector Switches

A S W 3 (1) (L) 20 - 304

Function

S: Selector Switch

Series Designation

W: TW Series

Number of Positions

- 2: 2-Position
- 3: 3-Position
- 4: 4-Position
- 5: 5-Position

Spring Return Action

Blank: Maintained

- 1: Spring return from Right (2 or 3 position)
- 2: Spring return from Left (2 or 3 position)
- 3: 2-Way spring return from Left and Right (3 position only)

Circuit Number

(Standard circuits shown on following pages and 718.)

Contact Arrangement Code

- 10: 1NO 01: 1NC
- 20: 2NO 02: 2NC
- 40: 4NO 04: 4NC
- 11: 1NO-1NC 22: 2NO-2NC



Operator Style Code

- Blank: Knob Operator
- L: Lever Operator
- K: Key Operator

- 1. Use only when interpreting part numbers. Do not use for developing part numbers.
- 2. Custom contact configurations available.
- 3. Custom key removable codes available.
- 4. Portions of part number inside () are optional.

Non-Illuminated Selector Switches (Assembled) continued

2-Position Selector Switches

Contact	Style				Part Number		
	Mounting	Operator Position			Maintained	Spring Return from Right	Spring Return from Left
		L	R				
1NO	1 2	0 0	X 0	Knob Lever Key	ASW210 ASW2L10 ASW2K10	ASW2110 ASW21L10 ASW21K10	ASW2210 ASW22L10 ASW22K10
1NC	1 2	X 0	0 0	Knob Lever Key	ASW201-116 ASW2L01-116 ASW2K01-116	ASW2101-116 ASW21L01-116 ASW21K01-116	ASW2201-116 ASW22L01-116 ASW22K01-116
1NO 1NC	1 2	X 0	0 X	Knob Lever Key	ASW211 ASW2L11 ASW2K11	ASW2111 ASW21L11 ASW21K11	ASW2211 ASW22L11 ASW22K11
2NO	1 2	0 0	X X	Knob Lever Key	ASW220 ASW2L20 ASW2K20	ASW2120 ASW21L20 ASW21K20	ASW2220 ASW22L20 ASW22K20
2NC	1 2	X X	0 0	Knob Lever Key	ASW202-104 ASW2L02-104 ASW2K02-104	ASW2102-104 ASW21L02-104 ASW21K02-104	ASW2202-104 ASW22L02-104 ASW22K02-104
2NO 2NC	1 2 3 4	0 X 0 X	X 0 X 0	Knob Lever Key	ASW222 ASW2L22 ASW2K22	ASW2122 ASW21L22 ASW21K22	ASW2222 ASW22L22 ASW22K22
2NO 2NC	1 2 3 4	0 0 X X	X X 0 0	Knob Lever Key	ASW222-111 ASW2L22-111 ASW2K22-111	ASW2122-111 ASW21L22-111 ASW21K22-111	ASW2222-111 ASW22L22-111 ASW22K22-111



Switches & Pilot Devices

Signaling Lights

Relays & Sockets

Timers

Contactors

Terminal Blocks

Circuit Breakers

Non-Illuminated Selector Switches (Assembled) continued

3-Position Selector Switches

Contact	Mounting	Style				Part Number			
		Operator Position				Maintained	Spring Return from Right	Spring Return from Left	Spring Return Two-Way
		L	C	R					
2NO	1 2	X 0	0 0	0 X	Knob Lever Key	ASW320 ASW3L20 ASW3K20	ASW3120 ASW31L20 ASW31K20	ASW3220 ASW32L20 ASW32K20	ASW3320 ASW33L20 ASW33K20
2NC	1 2	0 X	X X	X 0	Knob Lever Key	ASW302 ASW3L02 ASW3K02	ASW3102 ASW31L02 ASW31K02	ASW3202 ASW32L02 ASW32K02	ASW3302 ASW33L02 ASW33K02
2NO 2NC	1 2 3 4	X 0 0 X	0 0 X X	0 X X 0	Knob Lever Key	ASW322 ASW3L22 ASW3K22	ASW3122 ASW31L22 ASW31K22	ASW3222 ASW32L22 ASW32K22	ASW3322 ASW33L22 ASW33K22
2NO 2NC	1 2 3 4	X X 0 0	0 X X 0	X 0 0 X	Knob Lever Key	ASW322-309 ASW3L22-309 ASW3K22-309	ASW3122-309 ASW31L22-309 ASW31K22-309	ASW3222-309 ASW32L22-309 ASW32K22-309	ASW3322-309 ASW33L22-309 ASW33K22-309
2NO 2NC	1 2 3 4	0 0 0 0	X 0 X 0	0 X 0 X	Knob Lever Key	ASW322-310 ASW3L22-310 ASW3K22-310	ASW3122-310 ASW31L22-310 ASW31K22-310	ASW3222-310 ASW32L22-310 ASW32K22-310	ASW3322-310 ASW33L22-310 ASW33K22-310
4NO	1 2 3 4	X 0 X 0	0 0 0 0	0 X 0 X	Knob Lever Key	ASW340 ASW3L40 ASW3K40	ASW3140 ASW31L40 ASW31K40	ASW3240 ASW32L40 ASW32K40	ASW3340 ASW33L40 ASW33K40
4NC	1 2 3 4	0 X 0 X	X X X X	X 0 X 0	Knob Lever Key	ASW304 ASW3L04 ASW3K04	ASW3104 ASW31L04 ASW31K04	ASW3204 ASW32L04 ASW32K04	ASW3304 ASW33L04 ASW33K04



- The truth table indicates the operating position of contact block when the operator is switched to that position.
X = On (closed contacts)
0 = Off (open contacts)
X—X = Overlapping Contacts: Remain on (closed contacts) when switch is moved between these two positions.
- All knob and lever selector switches come in black. Other colors are available by ordering the knob or lever separately.
- Every key selector switch uses an identical key. The key is removable in any maintained position.
- Custom contact configurations are available, see page 718.

4-Position Selector Switch

Contact	Mounting	Style					Maintained
		Operator Position					Part Number
		1	2	3	4		
2NO 2NC	1 2 3 4	X 0 0 0	0 X 0 0	0 0 X 0	0 0 0 X	Knob Lever	ASW422-411 ASW4L22-411

5-Position Selector Switch

Contact	Mounting	Style						Maintained
		Operator Position						Part Number
		1	2	3	4	5		
2NO 2NC	1 2 3 4	X 0 0 0	0 X 0 0	0 0 0 0	0 X 0 0	0 0 0 X	Knob Lever	ASW522-501 ASW5L22-501

Non-Illuminated Selector Switches (Sub-Assembled)

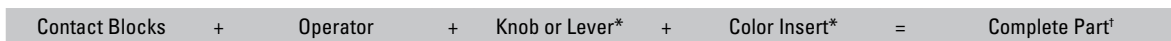

- 1. *Not needed with key type switches.
- 2. †Knob type shown.

Operators

Style	Positions	Description	Part Number	
Knob/Lever 	2	Maintained	ASW200	
		Spring return from right	ASW2100	
		Spring return from left	ASW2200	
	3	Maintained, Cam 1 Maintained, Cam 2 Maintained, Cam 3		ASW300-1 ASW300-2 ASW300-3
			Spring return from right, Cam 1 Spring return from right, Cam 2	ASW3100-1 ASW3100-2
			Spring return from left, Cam 1 Spring return from left, Cam 2	ASW3200-1 ASW3200-2
		Spring return from left/right, Cam 1 Spring return from left/right, Cam 2	ASW3300-1 ASW3300-2	
		4	Maintained, Standard Cam	ASW400
			Maintained, Cam 1	ASW400-1
5	Maintained, Standard cam	ASW500		
	Maintained, Cam 1	ASW500-1		
Key 	2	Maintained	ASW2K00	
		Spring return from right	ASW21K00	
		Spring return from left	ASW22K00	
	3	Maintained, Cam 1 Maintained, Cam 2 Maintained, Cam 3		ASW3K00-1 ASW3K00-2 ASW3K00-3
			Spring return from right, Cam 1 Spring return from right, Cam 2	ASW31K00-1 ASW31K00-2
			Spring return from left, Cam 1 Spring return from left, Cam 2	ASW32K00-1 ASW32K00-2
		Spring return from left/right, Cam 1 Spring return from left/right, Cam 2	ASW33K00-1 ASW33K00-2	

- 1. Two keys are supplied with every key switch, all are keyed alike, and removable from any maintained position.
- 2. Locking rings are included with all operators. Order knobs, levers, and color inserts separately.
- 3. Different cams produce different contact actions. For details, see page 718.
- 4. Key switch operator supplied with black sleeve.

① Handle/Insert Color Codes

Color	Code
Black*	B
Blue	S
Green	G
Red	R
Yellow	Y
White†	W

- *Color inserts not available in black.
- †Knob and lever not available in white.

Replacement Parts

Key Switch Black Sleeve	AKW2B-B
-------------------------	---------

Handles and Inserts

Style	Part Number
Knob 	ASWHHY-①
Lever 	ASWHHL-①
Color Insert 	TW-HC1-①

Contact Blocks

Style	Contacts	1NO	1NC
	Finger-Safe Spring-Up Terminal	HW-U10-F	HW-U01-F
		HW-U10R-F (early make)	HW-U01R-F (late break)
	Dummy Block	HW-DB	

- 1. Push rod color code:
Green = NO contact block
Red = NC contact block.
- 2. Dummy blocks (no contacts) are used with an odd number of contact blocks.

Illuminated Selector Switches (Assembled)



Assembled Illuminated Selector Switches

A SL W 2 (2) 99 11 (D) - (103) - R - (24V)

Function

SL: Illuminated Selector Switch

Series Designation

W: TW series

Number of Positions

2: 2-Position
3: 3-Position

Spring Return Action

Blank: Maintained
1: Spring return from Right
2: Spring return from Left
3: Two-Way spring return from Left and Right

Illumination Circuit

99: Full Voltage (lamp determines voltage)
126: 120V AC Step Down Transformer
246: 240V AC Step Down Transformer
486: 480V AC Step Down Transformer

Lamp Voltage

(Full Voltage Units Only)

6V: 6V AC/DC
12V: 12V AC/DC
24V: 24V AC/DC
120V: 120V AC
240V: 240V AC

Lens Color Code

A: Amber
G: Green
R: Red
S: Blue
W: White
Y: Yellow

Contact Circuit Number

Standard circuits are listed on the following pages and 718.

Lamp Type

D: LED Lamp

Contact Arrangement

10: 1NO	01: 1NC
20: 2NO	02: 2NC
40: 4NO	04: 4NC
11: 1NO-1NC	22: 2NO-2NC

1. Use only when interpreting part numbers. Do not use for developing part numbers.
2. All transformers step down to 6V (use 6V lamp).

Illuminated Selector Switches(Assembled) continued

Illuminated 2-Position Selector Switches

Style				Lamp Circuit Type	Part Number		
Contact	Mounting	Operator Position			Maintained	Spring Return from Right	Spring Return from Left
		L	R				
1NO 1NC	1 2	0 X	X 0	Transformer Full Voltage	ASLW2 ① 11D-② ASLW29911D-②-③	ASLW21 ① 11D-② ASLW219911D-②-③	ASLW22 ① 11D-② ASLW229911D-②-③
2NO	1 2	0 0	X X	Transformer Full Voltage	ASLW2 ① 20D-② ASLW29920D-②-③	ASLW21 ① 20D-② ASLW219920D-②-③	ASLW22 ① 20D-② ASLW229920D-②-③
2NC	1 2	X X	0 0	Transformer Full Voltage	ASLW2 ① 02D-104-② ASLW29902D-104-②-③	ASLW21 ① 02D-104-② ASLW219902D-104-②-③	ASLW22 ① 02D-104-② ASLW229902D-104-②-③
2NO 2NC	1 2 3 4	0 X 0 X	X 0 X 0	Transformer Full Voltage	ASLW2 ① 22D-② ASLW29922D-②-③	ASLW21 ① 22D-② ASLW219922D-②-③	ASLW22 ① 22D-② ASLW229922D-②-③

① Transformer Voltage Codes

Voltage	Code
120VAC	126
240VAC	246
480VAC	486

Transformers step down to 6V (use 6V LED).

② LED/Lens Color Codes

Color	Code
Amber	A
Green	G
Red	R
Blue	S
White	W
Yellow	Y

Illuminated 3-Position Selector Switches, Maintained and Spring Return from Right

Style					Lamp Circuit Type	Part Number			
Contact	Mounting	Operator Position				Maintained	Spring Return From Right	Spring Return from Left	Spring Return Two-Way
		L	C	R					
2NO	1 2	X 0	0 0	0 X	Transformer Full Voltage	ASLW3 ① 20D-② ASLW39920D-②-③	ASLW31 ① 20D-② ASLW319920D-②-③	ASLW32 ① 20D-② ASLW329920D-②-③	ASLW33 ① 20D-② ASLW339920D-②-③
2NC	1 2	0 X	X X	X 0	Transformer Full Voltage	ASLW3 ① 02D-② ASLW39902D-②-③	ASLW31 ① 02D-② ASLW319902D-②-③	ASLW32 ① 02D-② ASLW329902D-②-③	ASLW33 ① 02D-② ASLW339902D-②-③
2NO 2NC	1 2 3 4	X 0 0 X	0 0 X X	0 X X 0	Transformer Full Voltage	ASLW3 ① 22D-② ASLW39922D-②-③	ASLW31 ① 22D-② ASLW319922D-②-③	ASLW32 ① 22D-② ASLW329922D-②-③	ASLW33 ① 22D-② ASLW339922D-②-③
2NO 2NC	1 2 3 4	X X 0 0	0 X X 0	X 0 0 X	Transformer Full Voltage	ASLW3 ① 22D-309-② ASLW39922D-309-②-③	ASLW31 ① 22D-309-② ASLW319922D-309-②-③	ASLW32 ① 22D-309-② ASLW329922D-309-②-③	ASLW33 ① 22D-309-② ASLW339922D-309-②-③
2NO 2NC	1 2 3 4	0 0 0 0	X 0 X 0	0 X 0 X	Transformer Full Voltage	ASLW3 ① 22D-310-② ASLW39922D-310-②-③	ASLW31 ① 22D-310-② ASLW319922D-310-②-③	ASLW32 ① 22D-310-② ASLW329922D-310-②-③	ASLW33 ① 22D-310-② ASLW339922D-310-②-③
4NO	1 2 3 4	X 0 X 0	0 0 0 0	0 X 0 X	Transformer Full Voltage	ASLW3 ① 40D-② ASLW39940D-②-③	ASLW31 ① 40D-② ASLW319940D-②-③	ASLW32 ① 40D-② ASLW329940D-②-③	ASLW33 ① 40D-② ASLW339940D-②-③
4NC	1 2 3 4	0 X 0 X	X X X X	X 0 X 0	Transformer Full Voltage	ASLW3 ① 04D-② ASLW39904D-②-③	ASLW31 ① 04D-② ASLW319904D-②-③	ASLW32 ① 04D-② ASLW329904D-②-③	ASLW33 ① 04D-② ASLW339904D-②-③

- 1. In place of ①, specify the Transformer Voltage Code.
- 2. In place of ②, specify the Lens/LED Color Code.
- 3. In place of ③, specify the Full Voltage Code.
- 4. For custom contact configurations, see page 718.
- 5. Light is independent of switch position.
- 6. Yellow selector switch comes with white LED.

③ Full Voltage Codes

Voltage	Code
6V AC/DC	6V
12V AC/DC	12V
24V AC/DC	24V
120V AC	120V
240V AC	240V

Switches & Pilot Devices

Signaling Lights

Relays & Sockets

Timers

Contactors

Terminal Blocks

Circuit Breakers



Illuminated Selector Switches (Sub-Assembled)

Transformer* + Contact Block + Operator + Lamp/Lead Holder¹ + LED + Lens = Complete Part



 *Full voltage units use a full voltage adaptor TW-DA1FB (even number of blocks) OR HW-DA1FBN (odd number of blocks) instead of a transformer.
¹Lamp holder is not included with operators, order separately.

Operators

Style	Positions	Description	Part Number
	2	Maintained	ASLW200
		Spring return from right	ASLW2100
		Spring return from left	ASLW2200
	3	Maintained, cam 1	ASLW300-1
		Maintained, cam 2	ASLW300-2
		Maintained, cam 3	ASLW300-3
	Spring return from right, cam 1	ASLW3100-1	
	Spring return from right, cam 2	ASLW3100-2	
	Spring return from left, cam 1	ASLW3200-1	
	Spring return from left, cam 2	ASLW3200-2	
	Spring return from left/right, cam 1	ASLW3300-1	
Spring return from left/right, cam 2	ASLW3300-2		

 Different cams produce different contact action. For details, see Contact Arrangements on page 718.

Lenses (Knobs)

Style	Part Number
Knob  	ASLWLU-②

 In place of ②, specify the lens color code from table.

Lamps

Style	Voltage	Part Number
	6V AC/DC	LSTD-6②
	12V AC/DC	LSTD-1②
	24V AC/DC	LSTD-2②
	120V AC	LSTD-H2②
	240V AC	LSTD-M4②

 1. In place of ②, specify the LED color code.
 2. The LED contains a current-limiting resistor and a protection diode.



② LED/Lens Color Codes

Color	Code
Amber	A
Green	G
Red	R
Blue	S
White	W
Yellow	Y

 Yellow LED not available. Use white LED

Illuminated Selector Switches (Sub-Assembled) continued

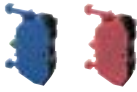
Contact Blocks

Style	Contacts	1NO	1NC
	Finger-Safe Spring-Up Terminal	HW-U10-F	HW-U01-F
		HW-U10R-F (early make)	HW-U01R-F (late break)
	Dummy Block	HW-DB	

-  1. Dummy blocks (no contacts) are used with an odd number of contact blocks.
- 2. Use of early and late break contacts creates a make before break function

Lamp Circuit Components

Style	Application	Part Number
Short Lamp Holder 	Used with full voltage adaptor and one contact block	TW-LH1
Long Lamp Holder 	Used with Full-size Transformer and two contact blocks	TW-LH2
Lead Holder 	Used with TW-LH2 holder when using four contact blocks and full size transformer	HW-LH3

Transformers/Full Voltage Modules

Style	Description	Part Number
Full Size Transformer 	120V AC	TW-F126B
	240V AC	TW-F246B
	480V AC	TW-F486B
Dummy Block with Full Voltage Adaptor	 For use with odd number of contacts. Finger-Safe	HW-DA1FBN
Full Voltage Adaptor	 For use with even number of contacts. Finger-Safe	TW-DA1FB

-  All Transformers step down to 6V (use 6V lamp).

Contact Arrangement Charts

How to Read Contact Arrangement Charts

To determine contact block mounting position, first make sure the selector switch is oriented as shown on the right

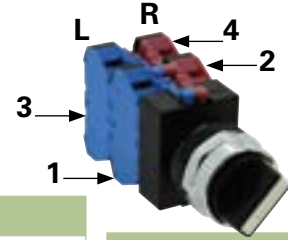

Contact Arrangement

Type and quantity of switch contacts

Circuit Number

* N/D = No designation required

Contact Block Mounting Position

Position or mounting contact blocks on operator.

Operator Position

Truth table indicates the operating position of contact block when operator is switched to that position (X - closed, O - open).

Contact Block Part Number

Part number to use when ordering sub-assembly contact blocks, as required for use with corresponding mounting position

Contact Arrangement Chart: 2-Position Selector Switches

Style		Mounting Position	Operator Position		Contact Block Part Number	Description	Operator Part Number		
Contact	Circuit Number		L	R			Maintained	Spring Ret. from Rt.	Spring Ret. from Lt.
1NO	N/D	1	0	X	HW-U10-F	Knob/Lever Key	ASW200 ASW2K00	ASW2100 ASW21K00	ASW2200 ASW22K00
		2	0	0	HW-DB	Illuminated Knob	ASLW200	ASLW2100	ASLW2200
1NC	116	1	X	0	HW-U01-F	Knob/Lever Key	ASW200 ASW2K00	ASW2100 ASW21K00	ASW2200 ASW22K00
		2	0	0	HW-DB	Illuminated Knob	ASLW200	ASLW2100	ASLW2200
1NO 1NC	N/D	1	0	X	HW-U10-F	Knob/Lever Key	ASW200 ASW2K00	ASW2100 ASW21K00	ASW2200 ASW22K00
		2	X	0	HW-U01-F	Illuminated Knob	ASLW200	ASLW2100	ASLW2200
1NO-EM 1NC-LB	600	1	0	X	HW-U10R-F	Knob/Lever Key	ASW200 ASW2K00	ASW2100 ASW21K00	ASW2200 ASW22K00
		2	X	0	HW-U01R-F	Illuminated Knob	ASLW200	ASLW2100	ASLW2200
1NO-EM 1NC-LB	601	1	X	0	HW-U01R-F	Knob/Lever Key	ASW200 ASW2K00	ASW2100 ASW21K00	ASW2200 ASW22K00
		2	0	X	HW-U10R-F	Illuminated Knob	ASLW200	ASLW2100	ASLW2200
2NO	N/D	1	0	X	HW-U10-F	Knob/Lever Key	ASW200 ASW2K00	ASW2100 ASW21K00	ASW2200 ASW22K00
		2	0	X	HW-U10-F	Illuminated Knob	ASLW200	ASLW2100	ASLW2200
2NC	104	1	X	0	HW-U01-F	Knob/Lever Key	ASW200 ASW2K00	ASW2100 ASW21K00	ASW2200 ASW22K00
		2	X	0	HW-U01-F	Illuminated Knob	ASLW200	ASLW2100	ASLW2200
2NO 2NC	N/D	1	0	X	HW-U10-F	Knob/Lever Key Illuminated Knob	ASW200 ASW2K00 ASLW200	ASW2100 ASW21K00 ASLW2100	ASW2200 ASW22K00 ASLW2200
		2	X	0	HW-U01-F				
		3	0	X	HW-U10-F				
		4	X	0	HW-U01-F				
2NO 2NC	111	1	0	X	HW-U10-F	Knob/Lever Key Illuminated Knob	ASW200 ASW2K00 ASLW200	ASW2100 ASW21K00 ASLW2100	ASW2200 ASW22K00 ASLW2200
		2	0	X	HW-U10-F				
		3	X	0	HW-U01-F				
		4	X	0	HW-U01-F				

- 1. NO-EM, NC-LB = Early Make, Late Break.
N/D = No circuit number designation required in assembled selector switch part number.
- 2. X = On (closed contacts) O = Off (Open contacts)

Contact Arrangement Chart: 3-Position Selector Switches

Style		Mounting Position	Operator Position			Contact Block Part Number	Description	Operator Part Number			
Contact	Circuit Number		L	C	R			Maintained	Spring Return from Right	Spring Return from Left	Two-Way
1NO 1NC	202	1	X	0	0	HW-U10-F	Knob/Lever Key	ASW300-1 ASW3K00-1 ASLW300-1	ASW3100-1 ASW31K00-1 ASLW3100-1	ASW3200-1 ASW32K00-1 ASLW3200-1	ASW3300-1 ASW33K00-1 ASLW3300-1
		2	X	X	0	HW-U01-F	Illuminated Knob				
	203	1	0	X	X	HW-U01-F	Knob/Lever Key	ASW300-1 ASW3K00-1 ASLW300-1	ASW3100-1 ASW31K00-1 ASLW3100-1	ASW3200-1 ASW32K00-1 ASLW3200-1	ASW3300-1 ASW33K00-1 ASLW3300-1
		2	0	0	X	HW-U10-F	Illuminated Knob				
	302	1	X	0	X	HW-U10-F	Knob/Lever Key	ASW300-2 ASW3K00-2 ASLW300-2	ASW3100-2 ASW31K00-2 ASLW3100-2	ASW3200-2 ASW32K00-2 ASLW3200-2	ASW3300-2 ASW33K00-2 ASLW3300-2
		2	X	X	0	HW-U01-F	Illuminated Knob				
303	1	0	X	0	HW-U01-F	Knob/Lever Key	ASW300-2 ASW3K00-2 ASLW300-2	ASW3100-2 ASW31K00-2 ASLW3100-2	ASW3200-2 ASW32K00-2 ASLW3200-2	ASW3300-2 ASW33K00-2 ASLW3300-2	
	2	0	0	X	HW-U10-F	Illuminated Knob					
2NO	N/D	1	X	0	0	HW-U10-F	Knob/Lever Key	ASW300-1 ASW3K00-1 ASLW300-1	ASW3100-1 ASW31K00-1 ASLW3100-1	ASW3200-1 ASW32K00-1 ASLW3200-1	ASW3300-1 ASW33K00-1 ASLW3300-1
		2	0	0	X	HW-U10-F	Illuminated Knob				
	301	1	X	0	X	HW-U10-F	Knob/Lever Key	ASW300-2 ASW3K00-2 ASLW300-2	ASW3100-2 ASW31K00-2 ASLW3100-2	ASW3200-2 ASW32K00-2 ASLW3200-2	ASW3300-2 ASW33K00-2 ASLW3300-2
		2	0	0	X	HW-U10-F	Illuminated Knob				
2NC	304	1	0	X	0	HW-U01-F	Knob/Lever Key	ASW300-2 ASW3K00-2 ASLW300-2	ASW3100-2 ASW31K00-2 ASLW3100-2	ASW3200-2 ASW32K00-2 ASLW3200-2	ASW3300-2 ASW33K00-2 ASLW3300-2
		2	X	X	0	HW-U01-F	Illuminated Knob				
	N/D	1	0	X	X	HW-U01-F	Knob/Lever Key	ASW300-1 ASW3K00-1 ASLW300-1	ASW3100-1 ASW31K00-1 ASLW3100-1	ASW3200-1 ASW32K00-1 ASLW3200-1	ASW3300-1 ASW33K00-1 ASLW3300-1
		2	X	X	0	HW-U01-F	Illuminated Knob				
2NO 2NC	N/D	1	X	0	0	HW-U10-F	Knob/Lever Key Illuminated Knob	ASW300-1 ASW3K00-1 ASLW300-1	ASW3100-1 ASW31K00-1 ASLW3100-1	ASW3200-1 ASW32K00-1 ASLW3200-1	ASW3300-1 ASW33K00-1 ASLW3300-1
		2	0	0	X	HW-U10-F					
		3	0	X	X	HW-U01-F					
		4	X	X	0	HW-U01-F					
	210	1	0	X	X	HW-U01-F	Knob/Lever Key Illuminated Knob	ASW300-1 ASW3K00-1 ASLW300-1	ASW3100-1 ASW31K00-1 ASLW3100-1	ASW3200-1 ASW32K00-1 ASLW3200-1	ASW3300-1 ASW33K00-1 ASLW3300-1
		2	0	0	X	HW-U10-F					
		3	0	X	X	HW-U01-F					
		4	0	0	X	HW-U10-F					
	308	1	X	0	X	HW-U10-F	Knob/Lever Key Illuminated Knob	ASW300-2 ASW3K00-2 ASLW300-2	ASW3100-2 ASW31K00-2 ASLW3100-2	ASW3200-2 ASW32K00-2 ASLW3200-2	ASW3300-2 ASW33K00-2 ASLW3300-2
		2	X	X	0	HW-U01-F					
		3	X	0	X	HW-U10-F					
		4	X	X	0	HW-U01-F					
309	1	X	0	X	HW-U10-F	Knob/Lever Key Illuminated Knob	ASW300-2 ASW3K00-2 ASLW300-2	ASW3100-2 ASW31K00-2 ASLW3100-2	ASW3200-2 ASW32K00-2 ASLW3200-2	ASW3300-2 ASW33K00-2 ASLW3300-2	
	2	X	X	0	HW-U01-F						
	3	0	X	0	HW-U01-F						
	4	0	0	X	HW-U10-F						
310	1	0	X	0	HW-U01-F	Knob/Lever Key Illuminated Knob	ASW300-2 ASW3K00-2 ASLW300-2	ASW3100-2 ASW31K00-2 ASLW3100-2	ASW3200-2 ASW32K00-2 ASLW3200-2	ASW3300-2 ASW33K00-2 ASLW3300-2	
	2	0	0	X	HW-U10-F						
	3	0	X	0	HW-U01-F						
	4	0	0	X	HW-U10-F						

1. Each operator sub-assembly is available as a "-1" and a "-2" for 3-position selector switches. The internal cam of a "-1" is different from that of a "-2". This results in designated combinations of open and closed contacts in the various operator positions.
2. N/D = No circuit number designation required in assembled part number.
3. X = On (closed contacts) 0 = Off (open contacts). X-X Overlapping contacts remain on (closed) when switch is moved between these two positions.

Switches & Pilot Devices
Signaling Lights
Relays & Sockets
Timers
Contactors
Terminal Blocks
Circuit Breakers

Contact Arrangement Chart: 3-Position Selector Switches

Style		Mounting Position	Operator Position			Contact Block Part Number	Description	Operator Part Number			
Contact	Circuit Number		L	C	R			Maintained	Spring Return from Right	Spring Return from Left	Two-Way
4NO	N/D	1	X	0	0	HW-U10-F	Knob/Lever Key Illuminated Knob	ASW300-1 ASW3K00-1 ASLW300-1	ASW3100-1 ASW31K00-1 ASLW3100-1	ASW3200-1 ASW32K00-1 ASLW3200-1	ASW3300-1 ASW33K00-1 ASLW3300-1
		2	0	0	X	HW-U10-F					
		3	X	0	0	HW-U10-F					
		4	0	0	X	HW-U10-F					
	305	1	X	0	X	HW-U10-F	Knob/Lever Key Illuminated Knob	ASW300-2 ASW3K00-2 ASLW300-2	ASW3100-2 ASW31K00-2 ASLW3100-2	ASW3200-2 ASW32K00-2 ASLW3200-2	ASW3300-2 ASW33K00-2 ASLW3300-2
		2	0	0	X	HW-U10-F					
		3	X	0	X	HW-U10-F					
		4	0	0	X	HW-U10-F					
4NC	N/D	1	0	X	X	HW-U01-F	Knob/Lever Key Illuminated Knob	ASW300-1 ASW3K00-1 ASLW300-1	ASW3100-1 ASW31K00-1 ASLW3100-1	ASW3200-1 ASW32K00-1 ASLW3200-1	ASW3300-1 ASW33K00-1 ASLW3300-1
		2	X	X	0	HW-U01-F					
		3	0	X	X	HW-U01-F					
		4	X	X	0	HW-U01-F					
	314	1	0	X	0	HW-U01-F	Knob/Lever Key Illuminated Knob	ASW300-2 ASW3K00-2 ASLW300-2	ASW3100-2 ASW31K00-2 ASLW3100-2	ASW3200-2 ASW32K00-2 ASLW3200-2	ASW3300-2 ASW33K00-2 ASLW3300-2
		2	X	X	0	HW-U01-F					
		3	0	X	0	HW-U01-F					
		4	X	X	0	HW-U01-F					

- 1. Each operator sub-assembly is available as a "-1" and a "-2" for 3-position selector switches. The internal cam of a "-1" is different from that of a "-2". This results in designated combinations of open and closed contacts in the various operator positions.
- 2. N/D = No circuit number designation required in assembled part number.
- 3. X = On (closed contacts) 0 = Off (open contacts). X-X Overlapping contacts remain on (closed) when switch is moved between these two positions.

Custom Selector Switch Building Guide

To build a custom selector switch, follow these steps.

Step 1

How many positions of the switch are needed?

of positions
(2, 3, 4, 5)

Step 2

How many contacts should there be?

of isolated contacts
(maximum 6)

Mounting Positions

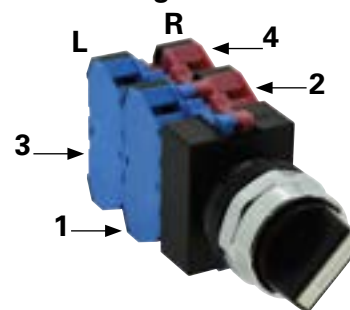

Step 3

Fill in the Truth Table

(X = closed, 0 = open)

		Knob Position				
		1	2	3	4	5
Contacts	1					
	2					
	3					
	4					
	5					
	6					

Step 4

If building a 2 position selector, skip this step. (2 position selectors have only one cam)

If building a 3, 4, or 5 position selector, determine appropriate cam as follows:

- Look at Row 1 from above table and locate an identical row in the operator truth tables (See next page).
- Repeat for all rows. The user must find one operator that contains all rows from above table.
- Record the operator cam version.

Step 5

Build by placing appropriate contact in appropriate mounting position for each desired row on operator cam truth table. "L" and "R" refer to mounting on left or right side of operator as viewed from the front of the panel.

Step 6

Develop an assembly part number (if necessary) as follows: follow standard numbering nomenclature for selector switches (see pages 710 or 714. In place of the "Circuit Number" indicate the cam number and contact arrangement as such ASW322-3-OELCXX, where "3" is the cam number, and contact arrangement "OELCXX" calls out individual contact mounting locations in order (see diagram above). O=NO, C=NC, E=NO-EM, L=NC-LB, X= no contact. Part number must designate all 6 possible mounting locations.



Caution: Before putting any custom selector switch into use, the user should use an ohmmeter to test for desired performance.

1. For Operator Truth Tables, see next page.

Operator Truth Tables

Use the following tables to build custom selector switches.

2 Position Selector Switches

	Contact	Mounting Position	Operator Position	
			Left	Right
ASW200 ASLW200 ASW2K00	HW-U10-F (NO)	L	0	X
		R	0	X
	HW-U01-F (NC)	L	X	0
		R	X	0
	HW-U10R-F (NO-EM)	L	0	X
		R	0	X
	HW-U01R-F (NC-LB)	L	X	0
		R	X	0

3 Position Selector Switches

	Contact	Mounting Position	Operator Position		
			Left	Center	Right
ASW300-1 ASW3K00-1 ASLW300-1	HW-U10-F (NO)	L	X	0	0
		R	0	0	X
	HW-U01-F (NC)	L	0	X	X
		R	X	X	0
	HW-U10R-F (NO-EM)	L	X	0	0
		R	0	0	X
	HW-U01R-F (NC-LB)	L	0	X	X
		R	X	X	0

	Contact	Mounting Position	Operator Position		
			Left	Center	Right
ASW300-2 ASW3K00-2 ASLW300-2	HW-U10-F (NO)	L	X	0	X
		R	0	0	X
	HW-U01-F (NC)	L	0	X	0
		R	X	X	0
	HW-U10R-F (NO-EM)	L	X	0	X
		R	0	0	X
	HW-U01R-F (NC-LB)	L	0	X	0
		R	X	X	0

	Contact	Mounting Position	Operator Position		
			Left	Center	Right
ASW300-3 ASW3K00-3 ASLW300-3	HW-U10-F (NO)	L	X	0	0
		R	0	0	X
	HW-U01-F (NC)	L	0	X	0
		R	0	X	0
	HW-U10R-F (NO-EM)	L	X	0	X
		R	X	0	X
	HW-U01R-F (NC-LB)	L	0	X	X
		R	X	X	0

4 Position Selector Switches

	Contact	Mounting Position	Operator Position			
			1	2	3	4
ASW400	HW-U10-F (NO)	L	X	0	0	0
		R	0	X	0	0
	HW-U01-F (NC)	L	0	X	X	X
		R	X	0	X	X
	HW-U10R-F (NO-EM)	L	X	0	0	0
		R	0	X	0	0
	HW-U01R-F (NC-LB)	L	0	X	X	X
		R	X	0	X	X

	Contact	Mounting Position	Operator Position			
			1	2	3	4
ASW400-1	HW-U10-F (NO)	L	X	0	0	0
		R	0	0	0	X
	HW-U01-F (NC)	L	0	0	X	0
		R	0	X	0	0
	HW-U10R-F (NO-EM)	L	X	X	0	X
		R	X	0	X	X
	HW-U01R-F (NC-LB)	L	0	X	X	X
		R	X	X	X	0

5 Position Selector Switches

	Contact	Mounting Position	Operator Position				
			1	2	3	4	5
ASW500	HW-U10-F (NO)	L	X	0	0	0	0
		R	0	X	0	0	0
	HW-U01-F (NC)	L	0	0	X	X	X
		R	0	0	0	X	X
	HW-U10R-F (NO-EM)	L	X	0	0	0	0
		R	0	X	0	0	0
	HW-U01R-F (NC-LB)	L	0	X	X	X	X
		R	X	0	X	X	X

	Contact	Mounting Position	Operator Position				
			1	2	3	4	5
ASW500-1	HW-U10-F (NO)	L	X	0	0	0	0
		R	0	0	0	0	X
	HW-U01-F (NC)	L	0	0	0	X	0
		R	0	X	0	0	0
	HW-U10R-F (NO-EM)	L	X	X	X	0	X
		R	X	0	X	X	X
	HW-U01R-F (NC-LB)	L	0	X	X	X	X
		R	X	X	X	X	0

Nameplates – TW Series

Faceplates

	NWAL	NWAQL	NWAS	EMERGENCY STOP
	Part Number			
Nameplate (blank)	NWAL-OB (black) NWAL-OR (red)	NWAQL-OB (black) NWAQL-OR (red)	NWAS-OB	NWAR-0
Nameplate (engraved)	NWAL-⓪	NWAQL-⓪	NWAS-⓪	NWAR-27†

- 1. In place of ⓪, insert either the Standard Legend Code from table below or custom engraving delimited by " ".
- 2. Standard engravings are available at no charge.
- 3. NWAR-27 comes marked "Emergency Stop" as shown in drawing.

Standard Legend Codes

Pushbuttons				Pushbuttons/Selector Switches				Selector Switches	
Legend	Code	Legend	Code	Legend	Code	Legend	Code	Legend	Code
AUTO	101	OPEN	116	AUTO-MAN	201			AUTO-MAN-OFF	301
CLOSE	102	OUT	117	CLOSE-OPEN	202			AUTO-OFF-MAN	302
DOWN	103	RAISE	118	DOWN-UP	203			CLOSE-OFF-OPEN	303
EMERG.STOP	104	RESET	119	FAST-SLOW	204			DOWN-OFF-SLOW	304
FAST	105	REVERSE	120	FOR-REV	205	REV-FOR	216	FAST-OFF-SLOW	305
FORWARD	106	RUN	121	HAND-AUTO	206	RUN-JOG	217	FOR-OFF-REV	306
HAND	107	SLOW	122	HIGH-LOW	207	RUN-SAFE	218	LEFT-OFF-RIGHT	307
HIGH	108	START	123	JOG-RUN	208	SAFE-RUN	219	LOWER-OFF-RAISE	308
IN	109	STOP	124	LEFT-RIGHT	209	SLOW-FAST	220	OFF-MAN-AUTO	309
INCH	110	STOP	125	LOWER-RAISE	210	START-STOP	221	OFF-SLOW-FAST	310
JOG	111	TEST	126	MAN-AUTO	211	STOP-START	222	OFF-1-2	311
LOW	112	UP	127	OFF-ON	212	UP-DOWN	223	OPEN-OFF-CLOSE	312
LOWER	113	I (Int'l On)	150	ON-OFF	213			SLOW-OFF-FAST	313
OFF	114	O (Int'l Off)	151	OPEN-CLOSE	214			SUMMER-OFF-WINTER	314
ON	115	EMO	152	RAISE-LOWER	215			UP-OFF-DOWN	315
								1-OFF-2	316
								HAND-OFF-AUTO	317

- 1. To order engraved nameplates, add legend code to nameplate part number. Character height based on the number of characters and size of nameplate. Standard character size is 3/16".
- 2. Nameplates with standard legends are the same list price as blank nameplates.

Nameplate Order Form on next page.

Switches & Pilot Devices

Signaling Lights

Relays & Sockets

Timers

Contactors

Terminal Blocks

Circuit Breakers

Custom Engraved Nameplates Order Form – TW Series

Copy this order form and use it to specify Letter Height, Custom Engravings, Location of Engraving on Nameplate, and Quantity Desired. To ensure engraving accuracy, fax it to your IDEC representative. or Distributor.

Your Company Name: _____ IDEC Rep/Distributor Contact: _____
 Your Name: _____ PO number (if known): _____
 Telephone: _____ IDEC Rep/Distributor Phone: _____
 Fax & Email: _____ IDEC Rep/Distributor Fax & Email: _____

NWAL

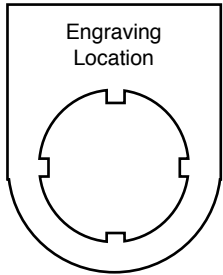

Step 1.

Choose Letter Size - 7/64" or 1/8".

Check the box for the letter size you want. Then write your lettering in box below checkboxes. Note: 1/8" size letters cannot exceed 9 characters.

7/64" Letter Size

11 characters max (for 7/64" size letters)

1/8" Letter Size

9 characters max (for 1/8" size letters)

Step 2.

Specify Quantity.

Enter the number of nameplates desired in the box on the right.

Qty

1 2 3 4 5 6 7 8 9 10 11

Sample Letter Sizes

7/64" Letters: A B C D

1/8" Letters: A B C D

NWAQL

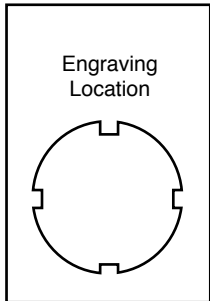

Step 1.

Choose Letter Size - 7/64" or 1/8".

Check the box for the letter size you want. Then write your lettering in box below checkboxes. Note: 1/8" size letters cannot exceed 9 characters.

7/64" Letter Size

11 characters max (for 7/64" size letters)

1/8" Letter Size

9 characters max (for 1/8" size letters)

Step 2.

Specify Quantity.

Enter the number of nameplates desired in the box on the right.

Qty

1 2 3 4 5 6 7 8 9 10 11

Sample Letter Sizes

7/64" Letters: A B C D

1/8" Letters: A B C D

NWAS

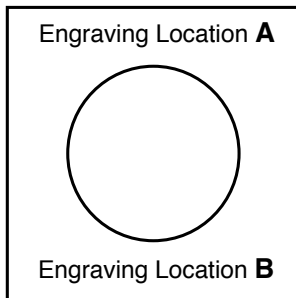

Step 1.

Choose Letter Size - 1/8" or 3/32".

Check the box for the letter size you want. Then write your lettering in box below checkboxes. Note: 1/8" size letters cannot exceed 14 characters.

3/32" Letter Size

20 characters max (for 3/32" size letters)

1/8" Letter Size

14 characters max (for 1/8" size letters)

Step 2.

Specify Quantity.

Enter the number of nameplates desired in the box on the right.

Qty

Step 3.

Specify Location.

Enter the location of engraving (A or B), in the box on the right.

Location

Sample Letter Sizes

3/32" Letters: A B C D

1/8" Letters: A B C D

1 2 3 4 5 6 7 8 9 10 11 12 13 14 15 16 17 18 19 20

Switches & Pilot Devices

Signalizing Lights

Relays & Sockets

Timers

Contactors

Terminal Blocks

Circuit Breakers

Switch Engraving Order Form – TW Series

Copy this order form and use it to specify Letter Height, Maximum Number of Lines and Text to be engraved.

To ensure engraving accuracy, fax it to your IDEC representative or Distributor.

Your Company: _____
 Name: _____
 Address: _____
 PO: _____

Telephone: _____
 Fax: _____
 Email: _____
 Part Number to be Engraved: _____

Please check one of the boxes below to indicate your choice of engraving options:



ø29mm, ø40mm Mushroom Head

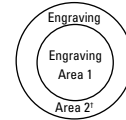

	# of Lines	Letter Height	Max. Characters Per Line
<input type="checkbox"/>	1	5/32	6
<input type="checkbox"/>		1/8	6
<input type="checkbox"/>	2	5/32	6
<input type="checkbox"/>		1/8	5
<input type="checkbox"/>	3	1/8	6
<input type="checkbox"/>	4	3/32	5

	# of Lines	Letter Height	Max. Characters Per Line
<input type="checkbox"/>	1	5/32	5
<input type="checkbox"/>		1/8	6
<input type="checkbox"/>	2	5/32	5
<input type="checkbox"/>		1/8	6
<input type="checkbox"/>	3	1/8	5
<input type="checkbox"/>	4	3/32	5

		# of Lines	Letter Height	Max. Characters Per Line
<input type="checkbox"/>	Engraving Area 1	1	5/32	5
<input type="checkbox"/>			1/8	5
<input type="checkbox"/>	Engraving Area 2	1	5/32	7
<input type="checkbox"/>			1/8	7



- Above mentioned specifications hold true for standard size pushbuttons (round and square).
- *Engraving Area 2 can be engraved for 40mm mushroom Head non-Illuminated push button only.
- Engraving is done on the button itself for non-Illuminated push buttons and on marking plate for illuminated push buttons and pilot lights.
- Please enter text exactly how you want it engraved, take care to emphasize capital or small letters.

Enter text to be engraved:

Line 1: _____
 Line 2: _____
 Line 3: _____
 Line 4: _____

Sample Letter Sizes

1/8 Letters: OPEN

5/32 Letters: OPEN

For IDEC Internal Use Only:

Work Order #: _____

Switches & Pilot Devices

Signaling Lights

Relays & Sockets

Timers

Contactors

Terminal Blocks

Circuit Breakers

Accessories

TW Series Accessories

Item	Appearance	Description/Usage		Part Number
Lamp Removal Tool		Rubber tool used to install or remove LED's		OR-55
Contact Block Remover		Used to remove contact blocks, transformers, lenses, and adaptors. Can also be used to determine panel thickness adjustment.		TW-KC1
Nut Locking Wrench		Used in OR-14 locking wrench to tighten locking nuts inside square bezel		TW-KQ2
Metal Bezel		Chrome plated bezels tighten onto operator (replacement for damaged bezels)	Standard octagonal units (chrome-pl.)	AW-R8
			Full shroud octagonal units (chrome-pl.)	AW-RF8
			Full shroud mushroom head units Ø 40mm	AW-G4
Plastic Bezel		Black plastic bezels for square buttons (replacement for damaged bezels)	Round flush units (black plastic)	AW-RP1B
			Round extended units (black plastic)	AW-FP1B
			Square units (black plastic)	AW-Q1B
			Square units with full shroud (black plastic)	AW-QF1B
Boot/Cover		Used to cover and protect pushbuttons	Waterproof lens cover for square pilot lights	APW00LN
			Waterproof lens cover for square illuminated buttons	APW00L
			Clear boot for round flush units	OC-31
			Clear boot for round extended units	OC-32
			In place of asterisk, specify Rubber Boot color: B (black), G (green), R (red), Y (yellow) - (nitril rubber)	OCW-11
Anti-Rotation Ring		Ring to prevent operator base from rotating in the mounting hole. Used when nameplate is not used		OGL-31
Mounting Hole Plug		Black rubber plug fills unused mounting holes in panel.		OB-31
Metallic Mounting Hole Plug		For plugging unused mounting holes in the panel. Tighten the attached locking ring to a torque of 12 kfg-cm maximum Degree of protection: IP66		LW9Z-BM
Replacement Keys		Replacement keys (#0)		TW-SK
Replacement Black Sleeve for Keyswitch				AKW2B-B

Item	Appearance	Description/Usage		Part Number																			
Metal Button Guard		Used on flush buttons to prevent inadvertent actuation		OLW-C																			
Terminal Tab Adaptor		Quick- connect terminals	#250 (17/64" x 3/64") single tab	TW-FA4																			
Lock-out Adaptor		Used to provide lock-out protection for pushbuttons and knob selector switches: • Up to Ø 40mm mushroom head size (Padlock not included.) Not applicable for e-stops.		HW9Z-KL1																			
22mm to 30mm Adaptor		Used to mount TW series control unit (except square units) Ø 7/8" (22mm) into a Ø 1-13/64" (30mm) panel cut-out.		TWN-A1R8																			
Contact Blocks (with side entry)		These contacts are applicable for wires terminated by ring, fork, not recommended for bare wire connections.	<table border="1"> <thead> <tr> <th></th> <th>1NC</th> <th>1NO</th> </tr> </thead> <tbody> <tr> <td>HW-U01</td> <td>HW-U01</td> <td>HW-U10</td> </tr> <tr> <td>HW-U01-MAU</td> <td>HW-U01-MAU</td> <td>HW-U10-MAU</td> </tr> <tr> <td>HW-U01R</td> <td>HW-U01R</td> <td>HW-U10R</td> </tr> <tr> <td>HW-U01R-MAU</td> <td>HW-U01R-MAU</td> <td>HW-U10R-MAU</td> </tr> <tr> <td>(with side entry)</td> <td>(with side entry)</td> <td>(with side entry)</td> </tr> </tbody> </table>				1NC	1NO	HW-U01	HW-U01	HW-U10	HW-U01-MAU	HW-U01-MAU	HW-U10-MAU	HW-U01R	HW-U01R	HW-U10R	HW-U01R-MAU	HW-U01R-MAU	HW-U10R-MAU	(with side entry)	(with side entry)	(with side entry)
				1NC	1NO																		
HW-U01	HW-U01	HW-U10																					
HW-U01-MAU	HW-U01-MAU	HW-U10-MAU																					
HW-U01R	HW-U01R	HW-U10R																					
HW-U01R-MAU	HW-U01R-MAU	HW-U10R-MAU																					
(with side entry)	(with side entry)	(with side entry)																					
Contact Blocks (without side entry)		These contacts are applicable for wires terminated by ring, fork, or ferule terminals, and also bare wire connections.	<table border="1"> <tbody> <tr> <td>HW-U01-F</td> <td>HW-U10-F</td> </tr> <tr> <td>HW-U01-MAU-F</td> <td>HW-U10-MAU-F</td> </tr> <tr> <td>HW-U01R-F</td> <td>HW-U10R-F</td> </tr> <tr> <td>HW-U01R-MAU-F</td> <td>HW-U10R-MAU-F</td> </tr> <tr> <td>(no side entry)</td> <td>(no side entry)</td> </tr> </tbody> </table>			HW-U01-F	HW-U10-F	HW-U01-MAU-F	HW-U10-MAU-F	HW-U01R-F	HW-U10R-F	HW-U01R-MAU-F	HW-U10R-MAU-F	(no side entry)	(no side entry)								
HW-U01-F	HW-U10-F																						
HW-U01-MAU-F	HW-U10-MAU-F																						
HW-U01R-F	HW-U10R-F																						
HW-U01R-MAU-F	HW-U10R-MAU-F																						
(no side entry)	(no side entry)																						

Switches & Pilot Devices

Signaling Lights

Relays & Sockets

Timers

Contactors

Terminal Blocks

Circuit Breakers

Dimensions

Pushbuttons

Flush

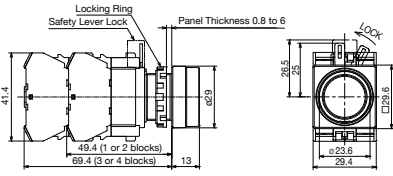

Extended

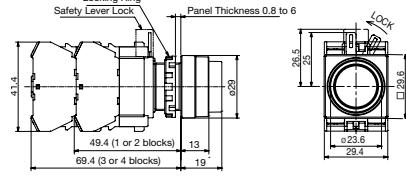

Extended with Full Shroud

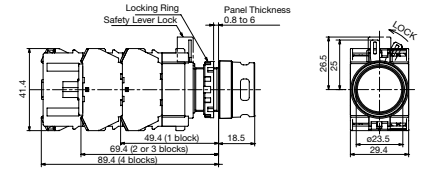

29mm Mushroom

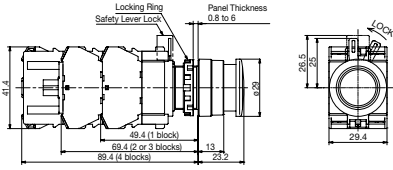

40mm Mushroom

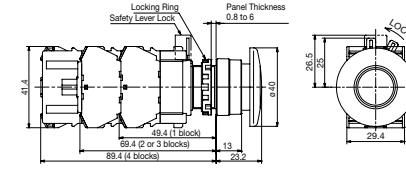

Mushroom with Full Shroud

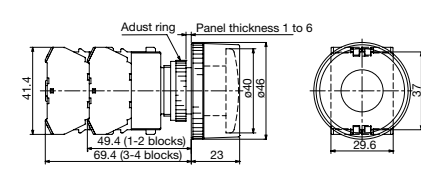

29mm Push-Lock-Turn-Reset

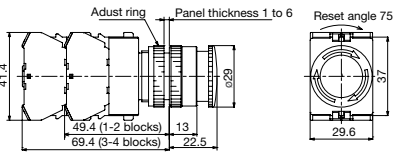

40mm Push-Lock-Turn-Reset

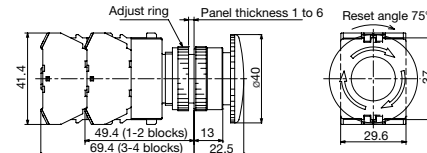

Keylock Push On/Off

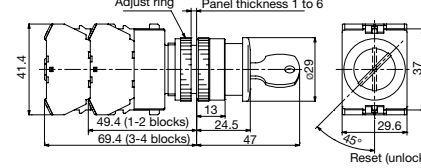

40mm Pushlock Key reset

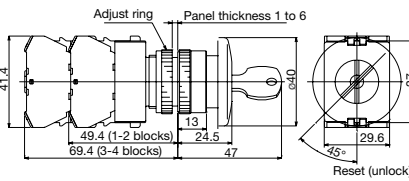

40mm Push-Pull

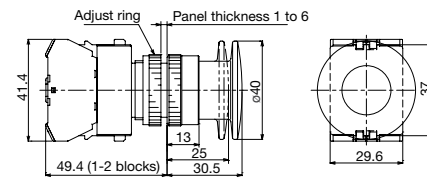

Square Flush

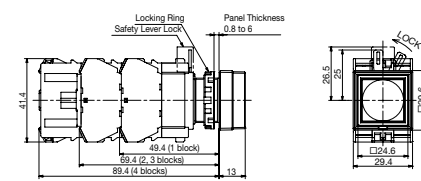

Square Extended

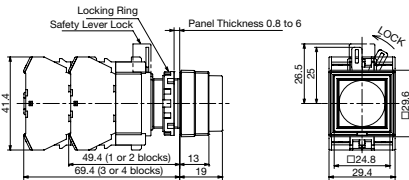

Selector Switches

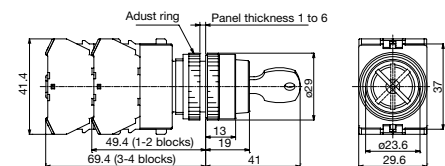
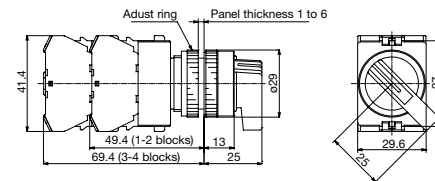
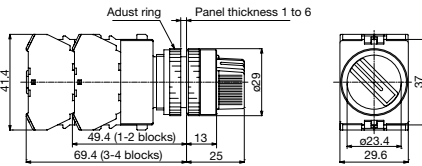

Dimensions continued

Illuminated Pushbuttons

Extended

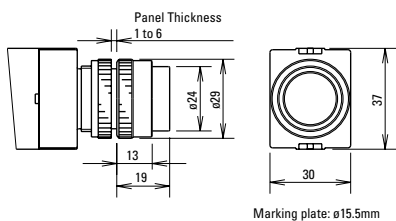

Extended with Full Shroud

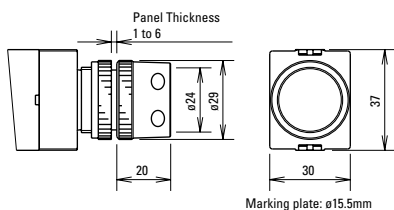

Square Extended

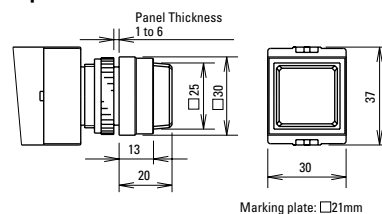

29mm Push-Turn-Reset

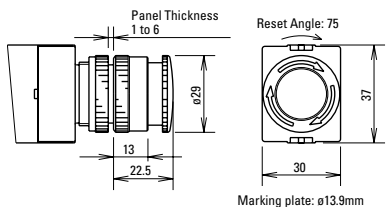

40mm Push-Turn-Reset

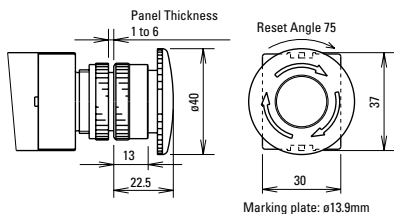

Mushroom

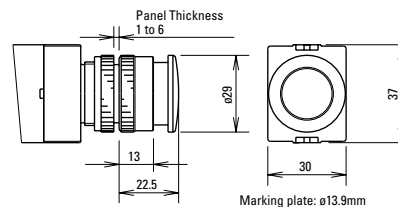

Push-Pull

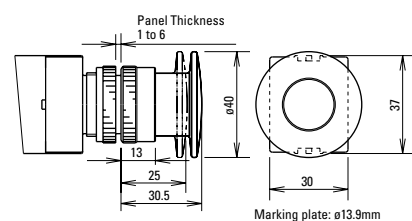

Illuminated Selector Switches

1 Contact Block with Full Voltage Adaptor

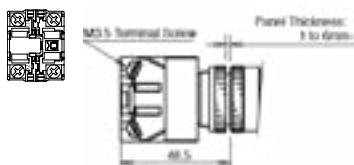

Transformer (2 blocks)

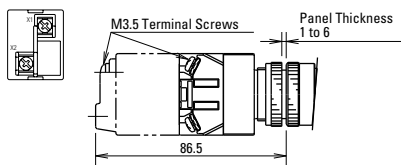

2 Contact Blocks with Full Voltage Adaptor

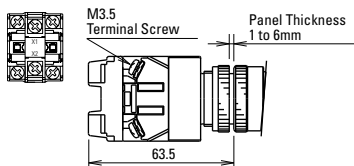

Transformer (4 blocks)

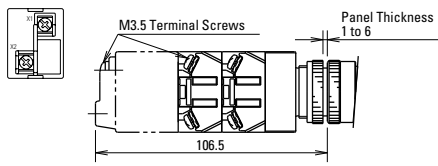

3 Contact Blocks with Full Voltage Adaptor

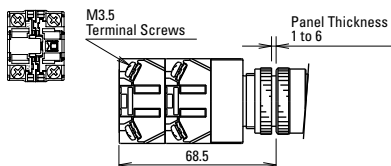

4 Contact Blocks with Full Voltage Adaptor

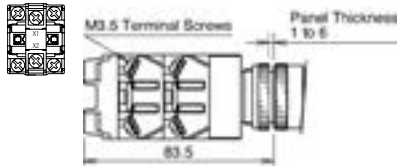

Dimensions continued

Pilot Lights

Round Flush APW1 Full Voltage

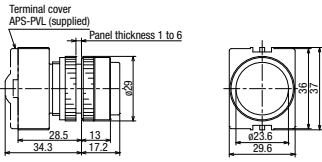

Round Flush APW1 Transformer

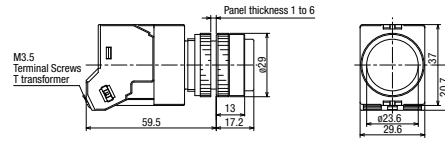

Round Flush Marking Type APW1B Full Voltage

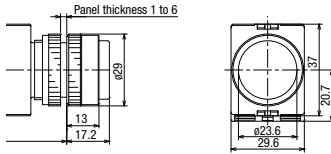

Round Flush Marking Type APW1B Transformer

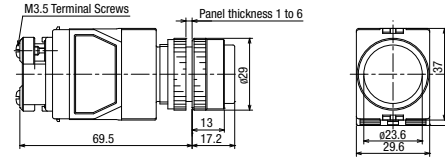

Dome APW2 Full Voltage

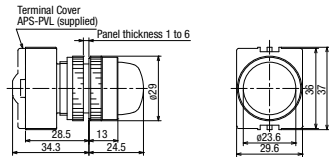

Dome APW2 Transformer

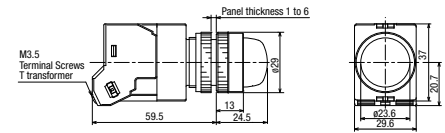

Square Flush Marking Type APQW1B Full Voltage

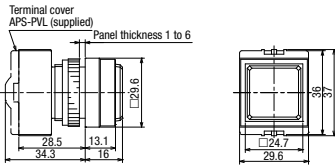

Square Flush Marking Type APQW1B Transformer

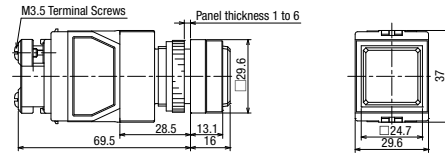

Illuminated Selector Switches

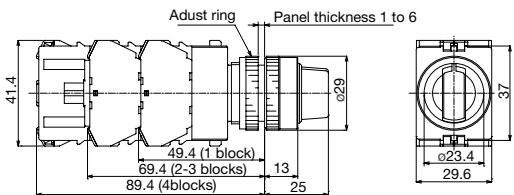

Dimensions continued

Panel Cut-Out

Diagram	Part	Dimension
	Pushbuttons	<ul style="list-style-type: none"> The minimum mounting centers are applicable to switches with one layer of contact blocks (one to two contact blocks). When two layers of contact blocks are mounted, determine the minimum mounting centers in consideration of convenience for wiring. <ul style="list-style-type: none"> 1*) ø40 mm mushroom button type: 40 mm minimum 1*) 2-position, 3-position lever selector switch: 39 mm minimum 1*) 4-position, 5-position lever selector switch: 50 mm minimum When high temperature is expected, take necessary measures such as securing sufficient mounting centers or using a cooling fan. The ☆3.2 $\frac{+0.2}{0}$ mm recess is for preventing rotation and is not necessary when the nameplate or anti-rotation ring is not used. <p>All dimensions in mm.</p>
	Pilot Light	
	Illuminated Pushbuttons	
	Selector Switches	
	Illuminated Selector Switches	

- The $\varnothing 0.137"$ ($\varnothing 3.5$ mm) recess is necessary when either the nameplate or anti-rotation ring is used.
- *1) $>1.404"$ (36mm) for 2- or 3-position.
 $>1.95"$ (50mm) for 4- or 5-position.

Accessory Dimensions

OGL-31
Anti-Rotation Ring

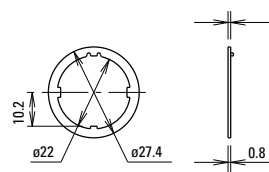

OLW-C
Metal Button Guard

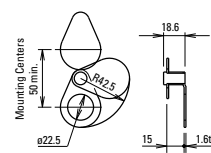

OCW-11
Pushbutton Rubber Boot

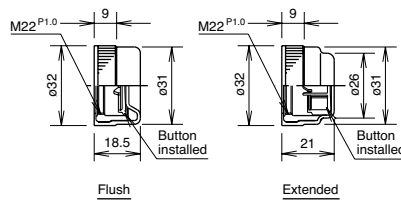

OB-31
Mounting Hole Rubber Plug

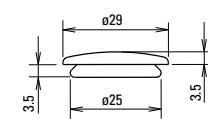

HW9Z-KL1
Lock-out Adaptor

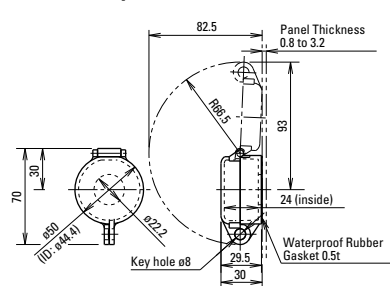

AW-RP1B
Round Plastic Bezel



AW-FP1B
Round Plastic w/Full Shroud



AW-QF1B
Square Full Shroud

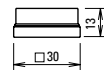

Finger-Safe Cover Dimensions

APS-PVL

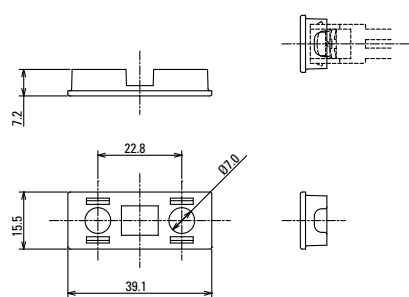

Switches & Pilot Devices

Signaling Lights

Relays & Sockets

Timers

Contactors

Terminal Blocks

Circuit Breakers

Component Construction and General Instructions – TW Series

Switches & Pilot Devices

Signaling Lights

Relays & Sockets

Timers

Contactors

Terminal Blocks

Circuit Breakers

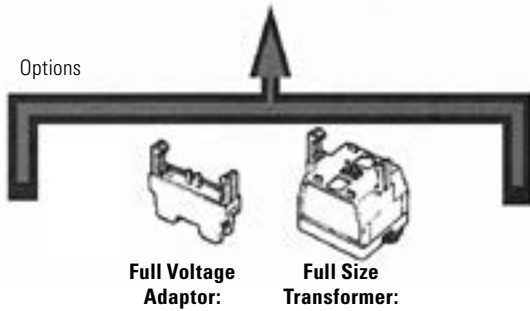
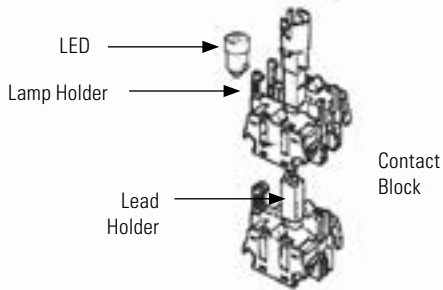
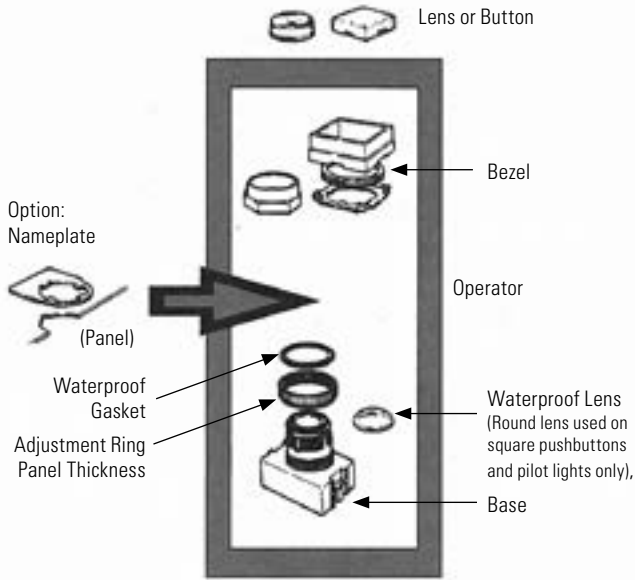

Instructions for Switches and Pilot Devices

TW Series: Adjustment for Panel Thickness

The panel thickness ring provides adjustment from 0.04" to 0.24" (1 to 6mm) in 0.004" (0.1mm) increments. Rotate the ring until the markings around the periphery are aligned for the desired thickness, as shown below.

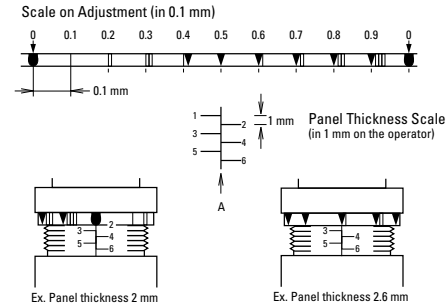

Note: When a nameplate or an anti-rotation ring is used, add 0.03" (0.8mm) to the panel thickness dimension.

An adjustment for panel thicknesses shown below can be made quickly by using the contact block remover.

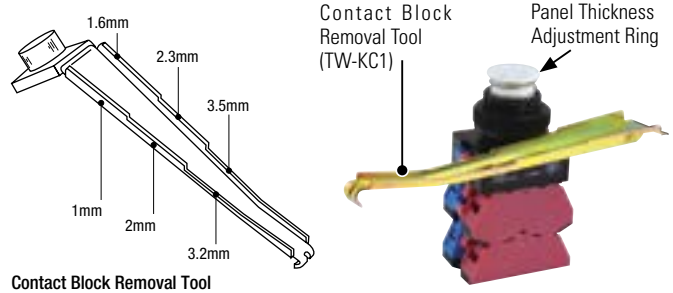

Instructions continued

Pilot Lights and Pushbuttons

IMPORTANT: Install the body of the TW control unit with the panel thickness scale facing up.

Octagonal and Round Bezels

Octagonal and round bezels screw into the operator. Use a locking ring wrench (optional) for secure tightening and easy removal. Round flush and extended buttons snap onto the operator base. Mushroom buttons screw onto the operator base.

Every round lens can be used with or without legend markings. Engraving can be done on a white translucent plate which is placed in the lens, or clear mylar can be printed and placed in the lens.

Round Marking Unit

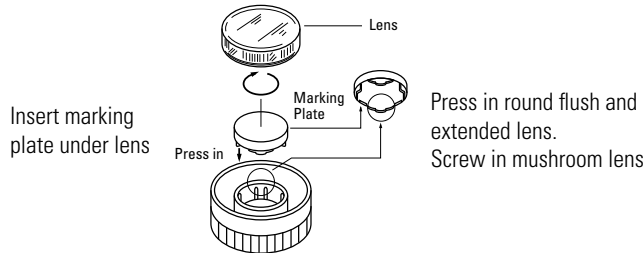

Square Bezels

Square bezels are installed in a 3-step procedure. First install the base plate from the front. Then install the lock nut using the nut locking wrench (optional). Finally, install the square bezel, which snap-fits onto the base plate. Square buttons also snap onto the operator base.

Every square lens can be used with or without legend markings. Engraving can be done on a white translucent plate which is placed in the lens, or clear mylar can be printed and placed in the lens. Square units include a round waterproof lens which screws into the operator. The square outer lens snaps on.

Square Marking Units

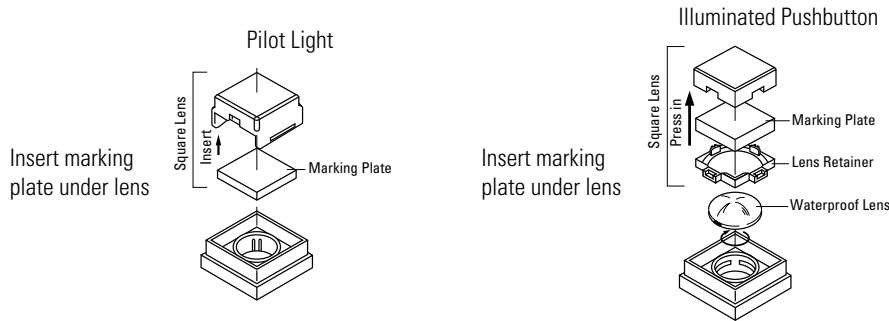

To remove square lens from operator, place a screwdriver under the indentation on the side of the lens. To remove the marking plate, place a screwdriver under the indentation and lift out the plate. The lens retainer can be removed by pressing a 3/16" screwdriver into one of the recesses.



Marking Plate Engraving Area

Shape	Engraving Area	Used With	Part Number
Round	Ø 0.55" (14mm)	Illuminated pushbuttons	ALW2B
	Ø 0.55" (14mm)	Pilot lights	APW2B
Mushroom	Ø 0.55" (14mm)	Illuminated mushroom	ALW3B
Square	□ 0.83" (21mm)	Square pilot lights	APQW1B
Square	□ 0.83" (21mm)	Square illuminated pushbuttons	ALQW2B

Instructions, continued

Selector Switches

The operator shaft of each unit has a recess to identify in which direction to install the handle. Align the handle with the recess. Press color insert (TW-HC1) into the handle and then press handle into the operator, as shown below.

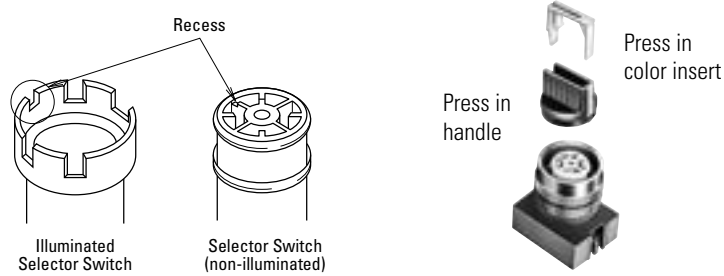

 Remove color insert before pulling out the handle.

Standard Operating Positions

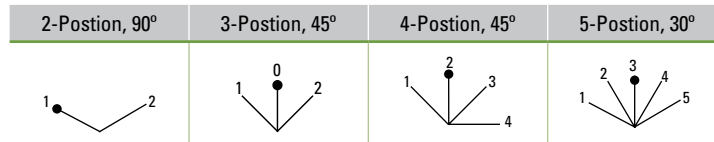

Positions: Non-Illuminated 3-Position Operators

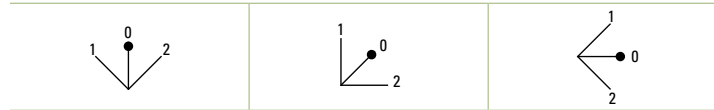

Installation of LED Illuminated Units

Transformers are recommended for use in areas subjected to inductive noise. When using full voltage types, install a protection diode as shown below. (Diode with DC power supply to protect against surges and noise.)

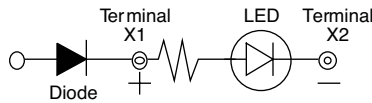

Enclosures for XW, HW & TW 22mm Switches and Pilot Devices

Key features:

- Three compact sizes (mm): 76 x 76, 140 x 76 and 200 x 76
- Available in 1, 2, 3, 4 or 5 mounting hole configurations
- Easy installation: panel, wall or frame mountable
- Polycarbonate enclosure cover and base, stainless steel screws
- UL Listed, RoHS Compliant
- IP65 and Type 4X rated (when installed with IP65 or Type 4X unit)
- Class II electric shock protection (when installed with applicable unit)
- Ideal for high temperatures (-25 to +60°C) and corrosive environments



Specifications

Operating Conditions	Ambient temperature	-25 to +60°C (no freezing)
	Relative humidity	45 to 85%RH (no condensation)
	Storage temperature	-40 to +80°C (no freezing)
	Degree of pollution	3
Degree of Protection	IP65 (when IP65 switches and pilot devices are installed) Type 4X (when Type 4X switches and pilot devices are installed)	
Electric Shock Protection	Class II (when class II switches and pilot devices are installed)	
Material	Cover and base	Polycarbonate
	Cover mounting screws	Stainless steel
Applicable Switches and Pilot Devices	HW, TW and XW series switches, pilot devices and accessories (see note below)	
Weight (approx.)	76mm type: 125g (FB1W-111Z) 140mm type: 184g (FB2W-211Z) 200mm type: 243g (FB3W-311Z)	



Choose switches, pilot devices and accessories that match the mounting hole centers, effective depth behind the cover, and the thickness of the cover where switches and pilot devices are installed (3 mm). Enclosures with 30 or 36mm mounting hole centers may limit the knob orientation of selector switches because the contact blocks can be mounted in one direction only on these mounting centers.

Enclosure Part Numbers

Size (mm)	Description	Part Number	Distance Between Hole Centers (mm)
76 x 76 x 59.5	Enclosure 1 hole, Yellow	FB1W-111Y	-
	Enclosure 1 hole, Beige	FB1W-111Z	-
140 x 76 x 59.5	Enclosure 2 hole, Beige	FB2W-211Z	50
	Enclosure 3 hole, Beige	FB2W-312Z	30
200 x 76 x 59.5	Enclosure 3 hole, Beige	FB3W-311Z	50
	Enclosure 4 hole, Beige	FB3W-413Z	36
	Enclosure 5 hole, Beige	FB3W-512Z	30

Accessories

Description	Part Number
Plug Adaptor 13.5mm	HW9Z-PG135
Mounting Bracket	FB9Z-PK1



Connectors and nuts are not supplied with accessories.

Switch and Pilot Device Accessories

Series	Description	Part Number
HW Series	Nameplate	HWAM, HWAQ, HWAS, HWAV
	Marking plate for nameplate	HWNP
	Anti-rotation ring	HW9Z-RL
	EMO switch guard	HW9Z-KG1, HW9Z-KG2, HW9Z-KG3, HW9Z-KG4
	Switch cover	HW9Z-K1, HW9Z-K11
	Pushbutton clear boot	OC-31, OC-32
	Padlock cover	HW9Z-KL1
XW Series E-Stops	Nameplate	HWAV
	EMO switch guard	HW9Z-KG1, HW9Z-KG2, HW9Z-KG3, HW9Z-KG4
	Anti-rotation ring	HW9Z-RL
	Nameplate	NWA, NWAQ, NWAAL-0, NWAAL-Q, NWAQAL-0, NWAQAL-Q
TW Series	Anti-rotation ring	OGL-31
	Metal button guard	OLW-C
	Pushbutton clear boot	OC-31, OC-32
	Button cover	OCW-11
	Padlock cover	HW9Z-KL1

Switches & Pilot Devices

Signaling Lights

Relays & Sockets

Timers

Contactors

Terminal Blocks

Circuit Breakers

External Dimensions (mm)

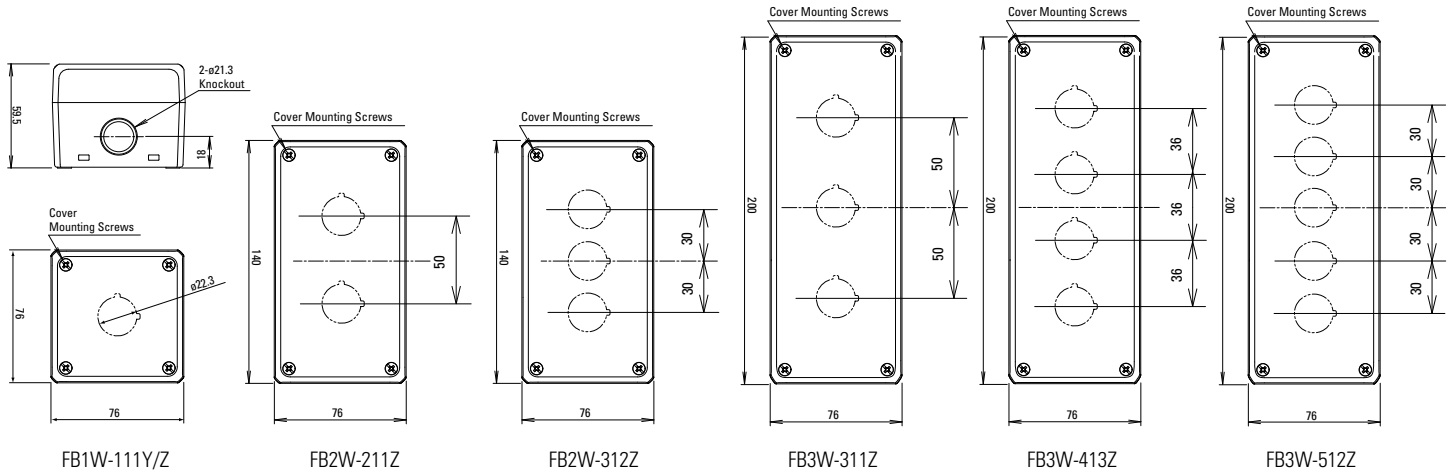

Internal Dimensions (mm)

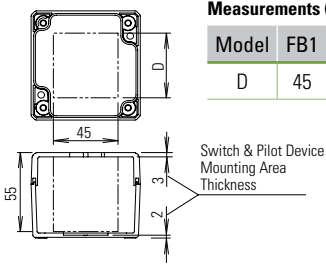

Measurements (mm)				
Model	FB1	FB2	FB3	
D	45	92	150	

External Back Dimensions (mm)

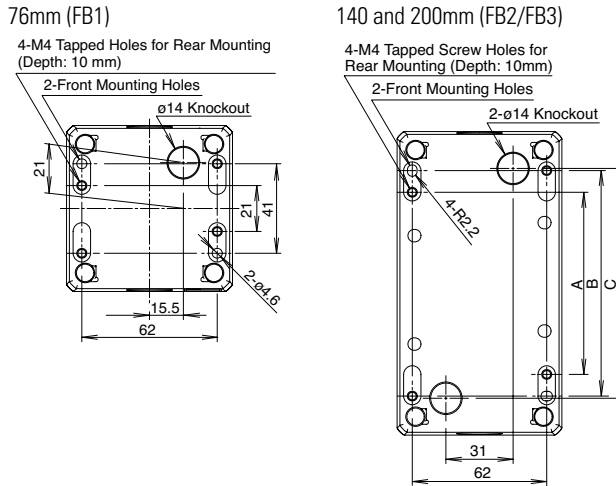

Measurements (mm)			
Model	FB2	FB3	
A	84	144	
B	104	164	
C	106	166	

Mounting

FB9Z-PK1 Frame Mounting Adapter

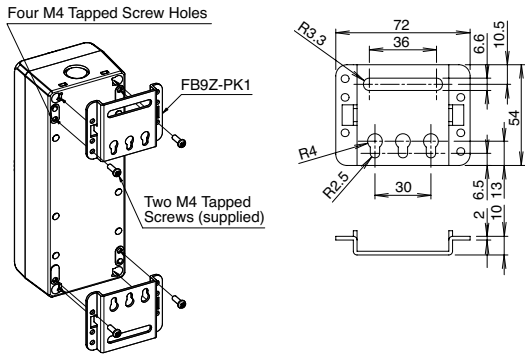

Mounting Hole Dimensions

Model	FB1	FB2	FB3	FB2/FB3
		50mm Mounting Centers	36/50mm Mounting Centers	30mm Mounting Centers
Shape				

30mm XN E-Stops

Key features:

- Plastic bezel, metallic padlock and flush bezel available
- Install up to 20 padlocks (XN4E)
- ø40, ø44 or ø60mm Mushroom heads available
- IDEC's original "safe break action" ensures that the contacts stay open when the contact block is detached from the operator.
- Safety-lock mechanism (IEC60947-5-5, 6.2)
- 2-in-1: Push-to-lock, Pull/Turn-to-Reset
- Push-ON LED model allows E-Stops to be illuminated only when latched
- Direct Opening Action mechanism (IEC60947-5-5, 5.2, IEC60947-5-1, Annex K)
- Very short panel depth
- Degree of protection IP65 (IEC60529)
- RoHS compliant (EU directive 2002/95/EC).
- XN4E series complies with OSHA and ISO 12100-2:2003 standards
- UL, c-UL listed, EN compliant
- UL NISD category emergency type device (File# E305148)



File No. E68961





Specifications



Applicable Standards	IEC60947-5-1, EN60947-5-1, IEC60947-5-5, EN60947-5-5, UL508, UL991, CSA C22.2 No. 14	
Operating Temperature	Non-illuminated: -25 to +60°C (no freezing), Illuminated: -25 to +55°C (no freezing)	
Operating Humidity	45 to 85% RH (no condensation)	
Storage Temperature	-45 to +80°C no freezing	
Operating Force	XN1E, XN5E Push-to-lock: 32N Pull-to-reset: 21N Turn-to-reset: 0.27 N·m	XN4E Push-to-lock: 32N Pull-to-reset: N/A Turn-to-reset: 0.4 N·m
Minimum Force Required for Direct Opening Action	80N	
Min Operator Stroke Required for Direct Opening Action	4mm	
Maximum Operator Stroke	4,5mm	
Contact Resistance	50mΩ maximum (initial value)	
Contact Material	Gold plated silver	
Insulation Resistance	100MΩ minimum (500V DC megger)	
Impulse Withstand Voltage	2.5kV	
Pollution Degree	3	
Operation Frequency	900 operations/hour	
Shock Resistance	Operating extremes: 150m/s ² (15G), Damage limits: 1000m/s ² (100G)	
Vibration Resistance	Operating extremes: 10 to 500Hz, amplitude 0.35mm acceleration 50m/s ² Damage limits: 10 to 500Hz, amplitude 0.35mm acceleration 50m/s ²	
Mechanical Life	250,000 operations minimum	
Electrical Life	100,000 operations minimum, (250,000 operations minimum @ 24V AC/DC, 100mA)	
Degree of Protection	Operator: IP65 (IEC60529) Terminal: IP20 (when XW9Z-VL2MF is installed)	
Terminal Style	M3.0 screw terminal	
Recommended Tightening Torque for Locking Ring	2.5N·m	
Wire Size	16 AWG max	
Weight	XN1E: Plastic bezel: 83g (ø40 mm), 93g (ø60 mm) 0.75 to 1.25 mm ² XN5E: Flush bezel: 89g XN4E: Padlock type: 120g	

Part Numbers



XN1E Plastic Bezel Type E-Stops (push-pull/twist reset)

Style	Operator Type	Main Contact	Monitor Contact	Part Number
Non-Illuminated 	40mm Mushroom	1NC	1NO	XN1E-BV411MR
		2NC	-	XN1E-BV402MR
		2NC	2NO	XN1E-BV422MR
		3NC	1NO	XN1E-BV413MR
	60mm Mushroom	4NC	-	XN1E-BV404MR
		1NC	1NO	XN1E-BV511MR
		2NC	-	XN1E-BV502MR
		2NC	2NO	XN1E-BV522MR
Illuminated 	40mm Mushroom LED (24V AC/DC)	3NC	1NO	XN1E-BV513MR
		4NC	-	XN1E-BV504MR
		1NC	1NO	XN1E-LV411Q4MR
		2NC	-	XN1E-LV402Q4MR
	40mm Mushroom Push-ON LED (24V AC/DC)	2NC	2NO	XN1E-LV422Q4MR
		3NC	1NO	XN1E-LV413Q4MR
		4NC	-	XN1E-LV404Q4MR
		2NC	1NO	XN1E-TV412Q4MR

XN4E Padlock Type E-Stops (push twist reset only)

Style	Operator Type	Main Contact	Monitor Contact	Part Number
Non-Illuminated 	44mm Mushroom	1NC	1NO	XN4E-BL411MR
		2NC	-	XN4E-BL402MR
		2NC	2NO	XN4E-BL422MR
		3NC	1NO	XN4E-BL413MR
		4NC	-	XN4E-BL404MR
Illuminated 	44mm Mushroom LED (24V AC/DC)	1NC	1NO	XN4E-LL411Q4MR
		2NC	-	XN4E-LL402Q4MR
		2NC	2NO	XN4E-LL422Q4MR
		3NC	1NO	XN4E-LL413Q4MR
	44mm Mushroom Push-ON LED (24V AC/DC)	4NC	-	XN4E-LL404Q4MR
		2NC	1NO	XN4E-TL412Q4MR

XN5E Flush Bezel Type E-Stops (push-pull/twist reset)

Style	Operator Type	Main Contact	Monitor Contact	Part Number
Non-Illuminated 	40mm Mushroom	1NC	1NO	XN5E-BV411MR
		2NC	-	XN5E-BV402MR
		2NC	2NO	XN5E-BV422MR
		3NC	1NO	XN5E-BV413MR
		4NC	-	XN5E-BV404MR
Illuminated 	40mm Mushroom LED (24V AC/DC)	1NC	1NO	XN5E-LV411Q4MR
		2NC	-	XN5E-LV402Q4MR
		2NC	2NO	XN5E-LV422Q4MR
		3NC	1NO	XN5E-LV413Q4MR
	40mm Mushroom Push-ON LED (24V AC/DC)	4NC	-	XN5E-LV404Q4MR
		2NC	1NO	XN5E-TV412Q4MR

Contact Ratings

Rated Insulation Voltage (Ui)		250V				
Rated Current (Ith)		5A				
Rated Operating Voltage (Ue)		30V	125V	250V		
Rated Operating Current	Main Contacts (NC)	AC 50/60Hz	Resistive Load (AC-12)	—	5A	3A
			Inductive Load (AC-15)	—	3A	1.5A
	DC	Resistive Load (DC-12)	2A	0.4A	0.2A	
		Inductive Load (DC-13)	1A	0.22A	0.1A	
Monitor Contacts (NO)	AC 50/60Hz	Resistive Load (AC-12)	—	1.2A	0.6A	
		Inductive Load (AC-14)	—	0.6A	0.3A	
	DC	Resistive Load (DC-12)	2A	0.4A	0.2A	
		Inductive Load (DC-13)	1A	0.22A	0.1A	

1. Minimum applicable load: 5V AC/DC, 1mA (reference value).
2. The rated operating currents are measured at resistive/inductive load types specified in IEC 60947-5-1.

Illuminated Unit LED Ratings

Model	Operating Voltage	Current
XN	24V AC/DC ±10%	15mA

Depth Behind the Panel

Model	Depth (mm)	Description
XN1E	47.7	1 - 4 contacts, plastic bezel
XN5E	60.4	1 - 4 contacts, flush bezel
XN4E	61.4	1 - 4 contacts, padlock

Mounting Hole Layout

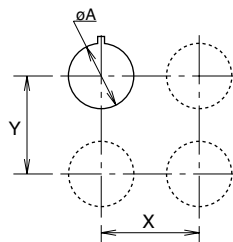

Measurements

Size	øA	X & Y
XN1E, XN5E	30.5 ^{+0.5}	70mm min
XN4E	30.5 ^{+0.5}	For XN4E, determine the values according to the size and number of padlocks and hasp.

Panel Cutout

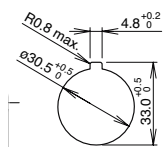

Part Numbers

XN1E - L V 4 02 Q4 MR

Bezel
 1: Plastic Bezel
 4: Padlock
 5: Flush Bezel

Illumination
 XN1E, XN5E
 BV: Non-Illuminated
 LV: Illuminated LED
 TV: Illuminated Push-ON LED
 XN4E
 BL: Non-Illuminated
 LL: Illuminated LED
 TL: Illuminated Push-ON LED

Mushroom Size
 4: ø40mm: XN1E, XN5E
 ø44mm: XN4E
 5: ø60mm
 (XN1E non-illuminated only)

Contact Configuration*
 11: 1NO - 1NC
 02: 2NC
 13: 1NO - 3NC
 22: 2NO - 2NC
 04: 4NC
 12: 1NO-2NC (Push-ON LED only)

Voltage Code
 Blank: Non-Illuminated
 Q4: 24V AC/DC (Illuminated & Push-ON LED type)

*Contact IDEC for additional configurations.

Terminal Arrangements (Bottom View)

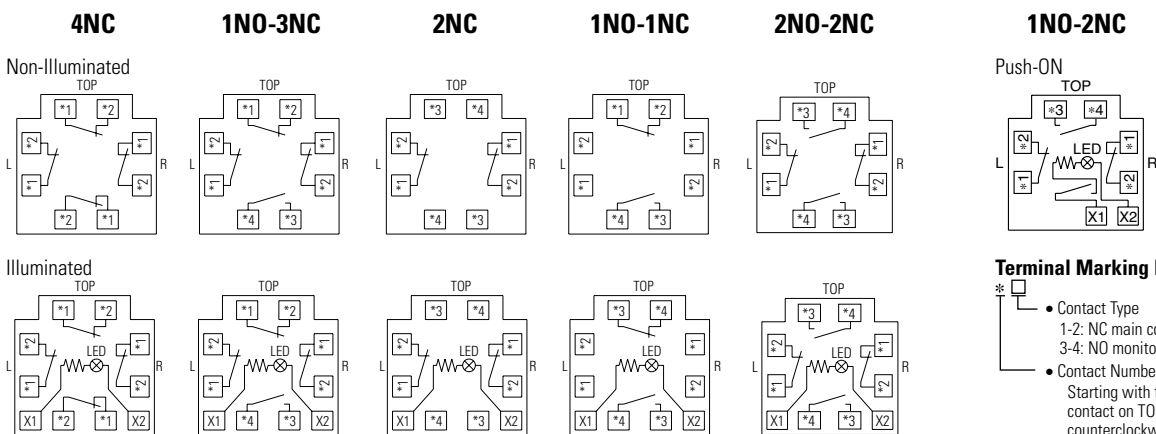

Terminal Marking Description

- Contact Type
 1-2: NC main contact
 3-4: NO monitor contact
- Contact Number (1-4)
 Starting with the contact on TOP in a counterclockwise direction.
 Note:
 1: contact on the TOP
 2: contact on the Left
 3: contact on the Bottom
 4: contact on the Right

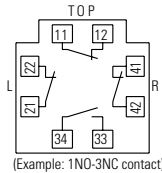

Switches & Pilot Devices

Signaling Lights

Relays & Sockets

Timers

Contactors

Terminal Blocks

Circuit Breakers

Dimensions (mm)

XN1E Non-Illuminated (with terminal cover)

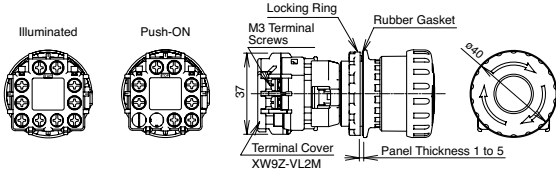
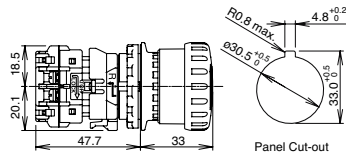

XN1E Illuminated/Push-ON (with terminal cover)

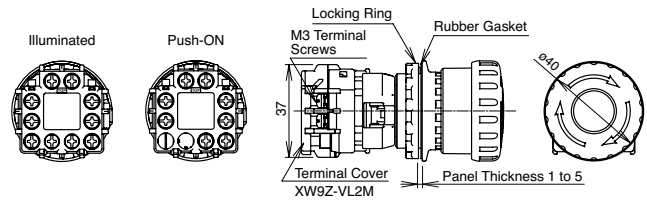
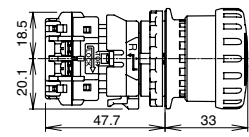

XN5E Illuminated (with terminal cover)

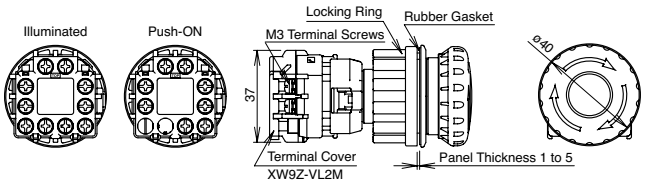
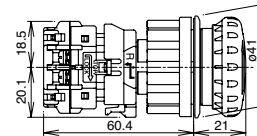

XN5E Non-Illuminated (with terminal cover)

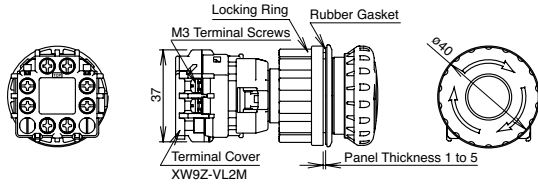
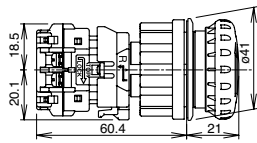

XN4E Illuminated (with terminal cover)

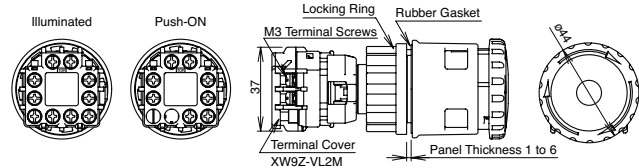
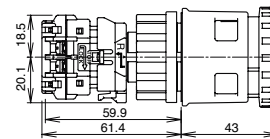

XN4E Non-Illuminated (with terminal cover)

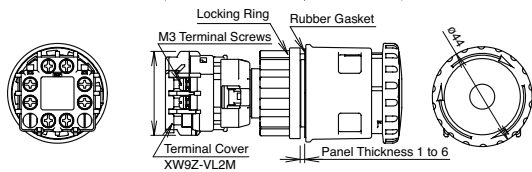
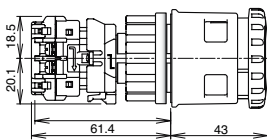

Nameplates

Item	Part No.	Legend	Mounting Panel Thickness
	HNAV-0	(blank)	XN4E: 1.0 to 4.5 mm
	HNAV-27	EMERGENCY STOP	XN1E, XN5E: 1.0 to 3.5 mm

Accessories

Item	Description	Part Number
	Locking Ring Wrench	XN9Z-T1
	Locking Ring Twist Wrench	TWST-T1
	Lockout Hasp	XN9Z-HASP421

Item	Description	Part Number
	Terminal Cover for Contact Block	XW9Z-VL2M
	IP20 Fingersafe Cover	XW9Z-VL2MF

Operating Instructions

Removing the Contact Block

First unlock the operator button. Grab the yellow bayonet ring ① and pull back the bayonet ring ② Turn counterclockwise until the latch pin clicks ③, then turn the contact block counterclockwise and pull out ③.

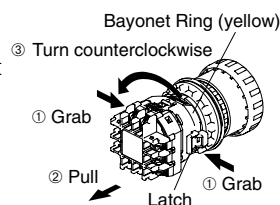

Notes for removing the contact block

1. Do not attempt to remove the contact block while the operator is latched, otherwise the switch may be damaged.
2. When the contact block is removed, the monitor contact (NO contact) is closed.
3. While removing the contact block, do not use excessive force, otherwise the switch may be damaged.
4. An LED lamp is built into the contact block for illuminated pushbuttons. When removing the contact block, pull the contact block straight to prevent damage to the LED lamp. If excessive force is used, the LED lamp may be damaged and fail to light.

Panel Mounting

Remove the locking ring from the operator and check that the rubber gasket is in place. Insert the operator from panel front into the panel hole. Face the side without thread on the operator with TOP marking upward, and tighten the locking ring using ring wrench XN9Z-T1 or TWST-T1 to a torque of 2.5 N·m maximum.

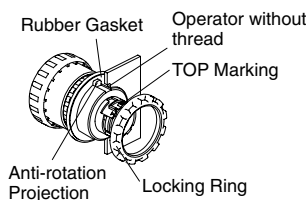

When using a nameplate

When using a nameplate HNAV-□, break the projection from the nameplate using pliers.



Installing the Contact Block

First unlock the operator button. Align the small ▼ marking on the edge of the operator with the small ▲ marking on the yellow bayonet ring. Hold the contact block, not the bayonet ring. Press the contact block onto the operator and turn the contact block clockwise until the bayonet ring clicks.

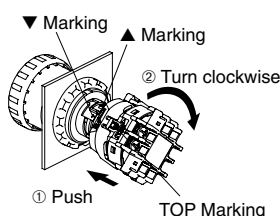

Notes for installing the contact block

1. Do not attempt to install the contact block when the operator is latched, otherwise the switch may be damaged.
2. Make sure that the bayonet ring is in the locked position.

Installing & Removing Terminal Covers

XW9Z-VL2M

To install the terminal cover, align the TOP marking on the terminal cover with the TOP marking on the contact block. Place the two projections on the bottom side of the contact block into the slots in the terminal cover. Press the terminal cover toward the contact block.

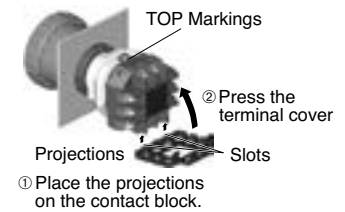

To remove the terminal cover, pull out the two latches on the top side of the terminal cover. Do not exert excessive force to the latches, otherwise the latches may break.

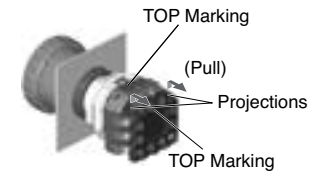

IP20 Fingersafe Terminal Cover XW9Z-VL2MF

To install the IP20 fingersafe terminal cover, align the TOP marking on the cover with the TOP marking on the contact block, and press the cover toward the contact block.

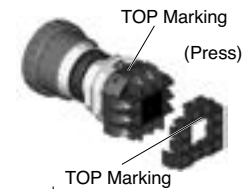

1. Once installed, the XW9Z-VL2MF cannot be removed.
2. With the XW9Z-VL2MF installed, crimping terminals cannot be used.
3. The XW9Z-VL2MF cannot be installed after wiring.
4. Make sure that the XW9Z-VL2MF is securely installed. IP20 cannot be achieved when installed loosely, and electric shock may occur.

Notes for Operation

When using the XN emergency stop switches in safety-related part of a control system, observe safety standards and regulations of the relevant country or region. Also be sure to perform a risk assessment before operation.

Wiring

Tighten the M3 terminal screws to a torque of 0.6 to 1.0 N·m.

Contact Bounce

When the button is reset by pulling or turning, the NC main contacts will bounce. When pressing the button, the NO monitor contacts will bounce.

When designing a control circuit, take the contact bounce time into consideration (reference value: 20 ms).

LED Illuminated Switches

LED lamp is built into the contact block and cannot be replaced.

Handling

Do not expose the switch to excessive shocks and vibrations, for example by operating the switch with tools. Otherwise the switch may be deformed or damaged, causing malfunction or operation failure.

Screw Terminal Type

1. AWG18 to 16
2. Tighten the M3 terminal screw to a tightening torque of 0.6 to 1.0 N·m.

Operating Instructions, continued

Screw Terminal Type

1. Wire thickness: 0.75 to 1.25 mm² (AWG18 to 16)

Applicable Crimping Terminals

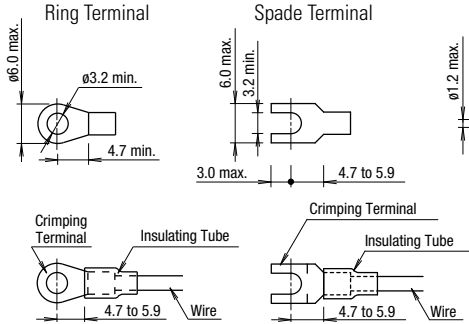

Solid Wire

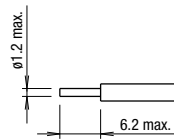

Be sure to install an insulating tube on the crimping terminal.

2. Tighten the M3 terminal screw to a tightening torque of 0.6 to 1.0 N·m.

To remove the terminal cover, pull out the two latches on the top side of the terminal cover. Do not exert excessive force to the latches, otherwise the latches may break.

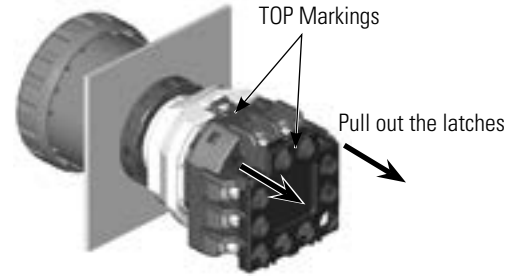

IP20 Protection Terminal Cover XW9Z-VL2MF

To install the IP20 protection cover, align the TOP marking on the cover with the TOP marking on the contact block, and press the cover toward the contact block.

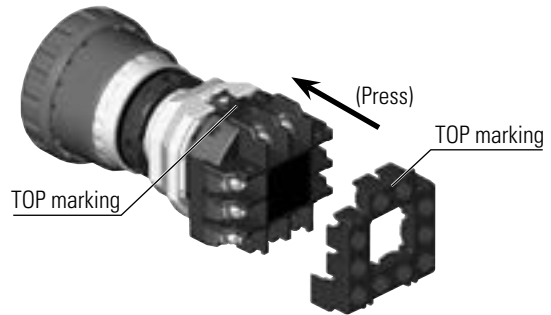

- 1. Once installed, the XW9Z-VL2MF cannot be removed.
- 2. The XW9Z-VL2MF cannot be installed after wiring. Use solid wires.
- 3. With the XW9Z-VL2MF installed, crimping terminals cannot be used. Use solid wires.
- 4. Make sure that the XW9Z-VL2MF is securely installed. IP20 cannot be achieved when installed loosely, and electric shocks may occur.

LED Illuminated Switches

An LED lamp is built into the contact block and cannot be replaced.

Installing the Anti-rotation Ring HW9Z-RL

Align the side without thread on the operator with TOP marking, the small s mark marking on the anti-rotation ring, and the recess on the mounting panel.

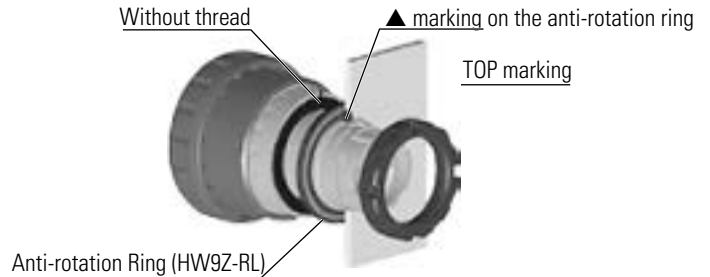

New TWND Series – Full Size NEMA Pushbuttons

**New! TWND Series: Heavy duty switches built to last****Key features:**

- Variety of button sizes up to 2 9/16" (65mm)
- Rugged construction includes chrome plated zinc locking ring die cast zinc mounting thread
- LED illumination
- Transformer or full voltage
- Slow make, double break wiping contacts
- Modular construction for maximum flexibility
- Available assembled or as sub-components
- UL Type 4X, 13 and IP65 watertight/oiltight panel

The rugged series of TWND switches offers both variety and durability in an attractive design.

With button sizes up to 2 9/16" (65mm), chrome plated zinc locking rings, die cast zinc mounting threads, steel anti-rotation rings, and self cleaning contacts, the TWNDs are here to stay.

The TWND series also offers LED illumination in full voltage and transformer models.

Regardless of your switching needs, the NEW TWND series provides the kind of long lasting, industrial strength quality you've come to expect from IDEC.



Switches & Pilot Devices

Signaling Lights

Relays & Sockets

Timers

Contactors

Terminal Blocks

Circuit Breakers

Specifications

Conforming to Standards	EN60947-5-1, UL508, CSA C22-2 No.14
Approvals	CSA: pushbuttons and selector switches: A600 pilot lights and illuminated pushbuttons, direct supply pilot lights and illuminated pushbuttons with integral transformer (100/110, 115, 120, 200/220, 230, 240, 380, 400/440, 480V) UL: pushbuttons and selector switches: A600 pilot lights and illuminated pushbuttons, direct supply pilot lights and illuminated pushbuttons with integral transformer (100/110, 115, 120, 200/220, 230, 240, 380, 400/440, 480V) TÜV: pushbuttons and selector switches: A600 pilot lights and illuminated pushbuttons, direct supply pilot lights and illuminated pushbuttons with integral transformer (100/110, 115, 120, 200/220, 230, 240, 380, 400/440, 480V)
Operating Temperature	Operation: -25 to +50°C (illuminated versions) -25 ~ +70C non-illuminated Storage: -40 to +80°C (without freezing) C-> °C
Vibration Resistance	5 to 55Hz, 98m/sec ² (10g) conforming to IEC60068-2-6
Shock Resistance	980m/sec ² (100g) conforming to IEC60068-2-27
Electric Shock Protection	Class 2 conforming to IEC60664-1
Degree of Protection	IP65 (from front of the panel) (conforming to IEC60529) UL Type 1, 2, 3, 3R, 3S, 4, 4X, 5, 12, 13 (conforming to NEMA ICS6-110)
Mechanical Life	Momentary pushbuttons: 5,000,000 (1800 operations per hour) All other switches: 500,000
Pollution Degree (conforming to IEC60947-1)	3

Mechanical-Electrical Specifications

Rated Operational Characteristics	AC-15: A600					
Rated Insulation Voltage	600V					
Rated Impulse Withstanding Voltage Dielectric Strength	Between live and dead metal parts 2.5kV AC, 1 minute					
Rated Thermal Current	10 Amp					
Minimum Switching Capacity	5 mA at 3V AC/DC (applicable range may vary with operating conditions and load types)					
Contact Operation	Slow break NC or NO					
Operating Force	Flush and extended pushbuttons—with 1NO or 1NC contact: 6.2±2N (momentary), 9.0±1.5N Additional contacts—1NO or 1NC: +3.0N					
Recommended Terminal Torque	Unit	Wire	Number of Wires	Recommended Tightening Torque (Nm)	Terminal Screw	
	HW-U Contact Block	Crimping Terminal		2	1.0 to 1.3	M3.5
		Solid Wire	ø0.5 to 1.6 mm (AWG14 to 22)	2	1.0 to 1.3	
			ø1.7 to 2.0 mm (AWG12)	1	1.2 to 1.3	
		Stranded Wire	0.3 to 2.0 mm ² (AWG14 to 22)	2	1.0 to 1.3	
	2.1 to 3.5 mm ² (AWG12)		1	1.2 to 1.3		
	Illuminated Unit (*1)	Crimping Terminal		2	1.0 to 1.3	M3.5
		Solid Wire	ø0.5 to 1.6 mm (AWG14 to 22)			
Applicable Wire Size	Pilot Light	Crimping Terminal			0.6 to 1.0 (M3.0)	
		Solid Wire	ø0.5 to 1.6 mm (AWG14 to 22)	2	1.0 to 1.3 (M3.5)	
		Stranded Wire	ø0.3 to 2.0 mm (AWG14 to 22)			
 1. * refers to the lamp terminals of the illuminated push buttons and selector switches.						
Contact Resistance	Initial contact resistance of 50mΩ or less					
Contact Gap	4mm (NO and NC) 2mm (NO-EM and NC-LB)					
LED Ratings	LEDs: 6V: 8mA, 12V: 11mA, 24V: 11mA, 120V: 8.8mA, 240V: 8.6mA					
Contact Material	Silver					

Contact Ratings

Contact Ratings by Utilization Category IEC 60947-5-1	AC-15 (A600)								
	DC-13 (P600)								
Contact Ratings by Utilization Category									
Operational Voltage			24V	48V	50V	110V	220V	440V	
Operation Current	AC 50/60 Hz	AC-12 Control of resistive loads & solid state loads	10A	—	10A	10A	6A	2A	
		AC-15 Control of electromagnetic loads (> 72VA)	10A	—	7A	5A	3A	1A	
	DC	DC-12 Control of resistive loads & solid state loads	10A	5A	—	2.2A	1.1A	—	
		DC-13 Control of electromagnets	5A	2A	—	1.1A	0.6A	—	

Non-Illuminated Pushbuttons (Assembled)

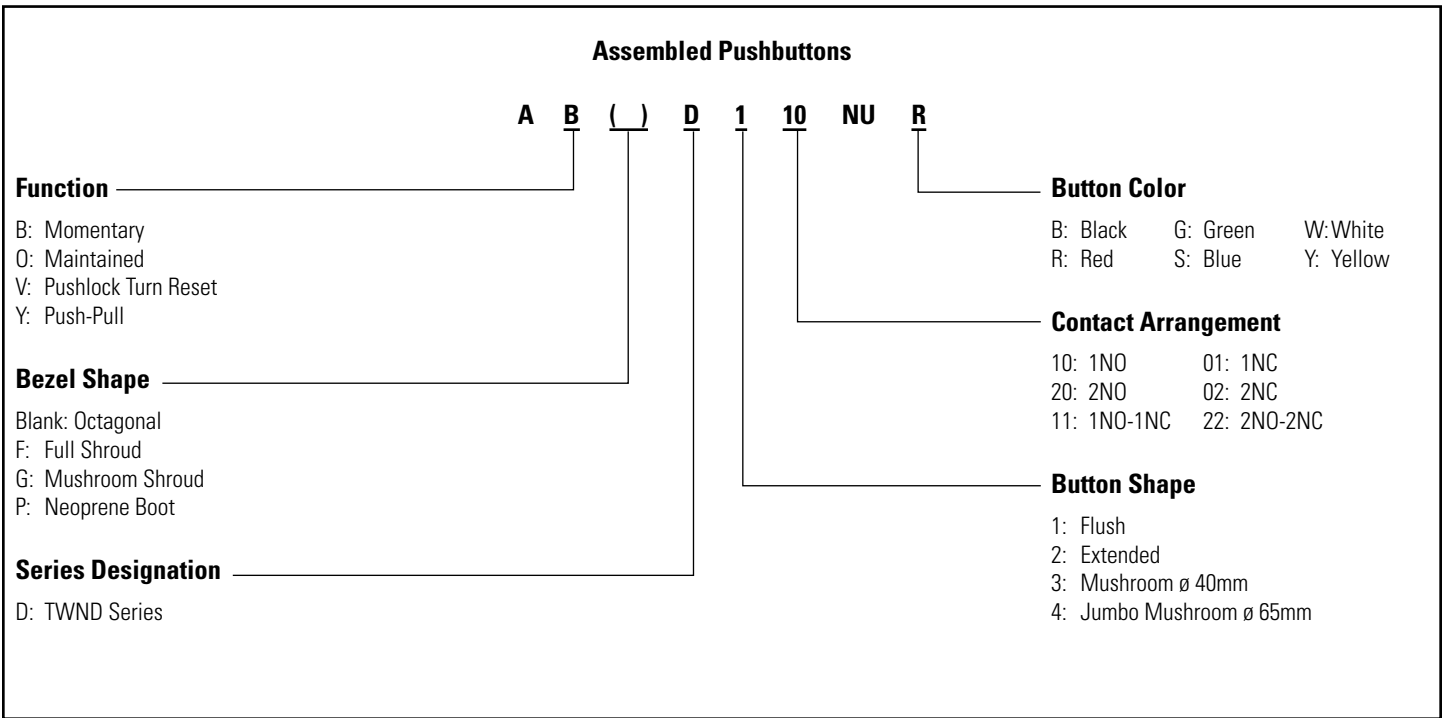

1. Use only when interpreting part numbers. Do not use for developing part numbers.
2. Custom contact configurations available, contact IDEC for details.

Non-Illuminated Pushbuttons (Assembled)

Non-Illuminated Pushbuttons

Style	Contacts	Momentary	Maintained
Flush	1NO	ABD110NUⓄ	AOD110NUⓄ
	1NC	ABD101NUⓄ	AOD101NUⓄ
	1NO-1NC	ABD111NUⓄ	AOD111NUⓄ
	2NO	ABD120NUⓄ	AOD120NUⓄ
	2NC	ABD102NUⓄ	AOD102NUⓄ
Extended	1NO	ABD210NUⓄ	AOD210NUⓄ
	1NC	ABD201NUⓄ	AOD201NUⓄ
	1NO-1NC	ABD211NUⓄ	AOD211NUⓄ
	2NO	ABD220NUⓄ	AOD220NUⓄ
	2NC	ABD202NUⓄ	AOD202NUⓄ
Extended with Neoprene Boot*	1NO	ABPD210NUⓄ	AOPD210NUⓄ
	1NC	ABPD201NUⓄ	AOPD201NUⓄ
	1NO-1NC	ABPD211NUⓄ	AOPD211NUⓄ
	2NO	ABPD220NUⓄ	AOPD220NUⓄ
	2NC	ABPD202NUⓄ	AOPD202NUⓄ
Recessed	1NO	ABFD110NUⓄ	AOFD110NUⓄ
	1NC	ABFD101NUⓄ	AOFD101NUⓄ
	1NO-1NC	ABFD111NUⓄ	AOFD111NUⓄ
	2NO	ABFD120NUⓄ	AOFD120NUⓄ
	2NC	ABFD102NUⓄ	AOFD102NUⓄ
Extended with Full Shroud	1NO	ABFD210NUⓄ	AOFD210NUⓄ
	1NC	ABFD201NUⓄ	AOFD201NUⓄ
	1NO-1NC	ABFD211NUⓄ	AOFD211NUⓄ
	2NO	ABFD220NUⓄ	AOFD220NUⓄ
	2NC	ABFD202NUⓄ	AOFD202NUⓄ
ø 40mm Mushroom Head	1NO	ABD310NUⓄ	AOD310NUⓄ
	1NC	ABD301NUⓄ	AOD301NUⓄ
	1NO-1NC	ABD311NUⓄ	AOD311NUⓄ
	2NO	ABD320NUⓄ	AOD320NUⓄ
	2NC	ABD302NUⓄ	AOD302NUⓄ
ø 40mm Mushroom Head with Full Shroud	1NO	ABGD310NUⓄ	AOGD310NUⓄ
	1NC	ABGD301NUⓄ	AOGD301NUⓄ
	1NO-1NC	ABGD311NUⓄ	AOGD311NUⓄ
	2NO	ABGD320NUⓄ	AOGD320NUⓄ
	2NC	ABGD302NUⓄ	AOGD302NUⓄ
ø 65mm Jumbo Mushroom Head	1NO	ABD410NUⓄ	AOD410NUⓄ
	1NC	ABD401NUⓄ	AOD401NUⓄ
	1NO-1NC	ABD411NUⓄ	AOD411NUⓄ
	2NO	ABD420NUⓄ	AOD420NUⓄ
	2NC	ABD402NUⓄ	AOD402NUⓄ
ø 65mm Jumbo Mushroom Head with Shallow Shroud	1NO	ABGD410NUⓄ	AOGD410NUⓄ
	1NC	ABGD401NUⓄ	AOGD401NUⓄ
	1NO-1NC	ABGD411NUⓄ	AOGD411NUⓄ
	2NO	ABGD420NUⓄ	AOGD420NUⓄ
	2NC	ABGD402NUⓄ	AOGD402NUⓄ
ø 65mm Jumbo Mushroom Head With Deep Shroud	1NO	ABFD410NUⓄ	AOFD410NUⓄ
	1NC	ABFD401NUⓄ	AOFD401NUⓄ
	1NO-1NC	ABFD411NUⓄ	AOFD411NUⓄ
	2NO	ABFD420NUⓄ	AOFD420NUⓄ
	2NC	ABFD402NUⓄ	AOFD402NUⓄ

① Button Color Codes

Color	Code
Black	B
Green	G
Red	R
Blue	S
Yellow	Y
White	W



1. 65mm Jumbo mushroom not available in white.
2. Neoprene boot is not available in blue or white.



1. In place of Ⓞ, specify the Button Color Code.
2. For sub-assembly part numbers, see next page.
3. *Neoprene boot available only in Black (B), Green (G), Red (R) and Yellow (Y).

Non-Illuminated Pushbuttons (Sub-Assembled)

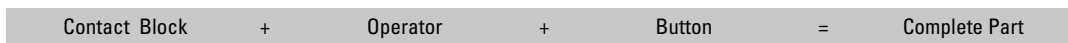

Operators

Style	Image	Part Number	
		Momentary	Maintained
Flush/Extended		ABD1200T8	AOD1200T8
Extended with Full Shroud		ALFD2300T8	AOLFD2300T8
ø 40mm Mushroom/ø 65mm Jumbo Mushroom		ABD3400T8	AOD3400T8
ø 40mm Mushroom with Full Shroud		ABGD-300T	AOGD-300T
ø 65mm Jumbo Mushroom with Shallow Shroud		ABGD-400T	AOGD-400T
ø 65mm Jumbo Mushroom with Deep Shroud		ABFD-400T	AOFD-400T

Buttons and Lenses

Style	Image	Part Number
Flush		ABD1BN-Ⓢ
Extended		ABD2BN-Ⓢ
ø 40mm Mushroom		ABD3BN-Ⓢ
ø 65mm Jumbo Mushroom		ABD4BN-Ⓢ



In place of Ⓢ, specify the Button Color Code. (See table previous page)

Contact Blocks

Style	Image	Part Number	
		1NO	1NC
All Control Units		HW-U10-F HW-U10R-F (early make)	HW-U01-F HW-U01R-F (late break)
Dummy Block		HW-DB	



- Dummy blocks (no contacts) are used with an odd number of contact blocks.
- Combining HW-U10R-F and HW-U01R-F result in overlapping contacts (remain on, or closed, when switch is moved between two positions).

Stop Switches (Assembled)



Assembled Stop Switches

A V (L) D 3 22 11 D NU R

Function

V: Pushlock Turn Reset
Y: Push-Pull

Illumination

Blank: None
L: Illuminated

Series Designation

D: TWND Series

Button/Lens Size

3: 40mm Mushroom

Illumination Circuit

Full Voltage:

66: 6VAC/DC

11: 12VAC/DC

22: 24AC/DC

QH2: 120VAC

QM4: 240VAC

Transformer:

126: 120VAC step down transformer

246: 240VAC step down transformer

486: 480VAC step down transformer

Button/Lens Color Code

A: Amber

G: Green

R: Red

S: Blue

W: White

Y: Yellow

(illuminated units only)

D: LED

Contact Arrangement

10: 1NO 01: 1NC

20: 2NO 02: 2NC

11: 1NO-1NC 22: 2NO-2NC



1. Use only when interpreting part numbers. Do not use for developing part numbers.
2. Custom contact configurations available, contact IDEC for details.

Stop Switches (Assembled)

Stop Switches

Style	Contacts	Part Number
ø 40mm Pushlock Turn Reset 	Non-Illuminated	1NO AVD310NUR* 1NC AVD301NUR* 1NO-1NC AVD311NUR* 2NO AVD320NUR* 2NC AVD302NUR*
	Full Voltage	1NO-1NC AVLD3③11DNUR* 2NO AVLD3③20DNUR* 2NC AVLD3③02DNUR*
ø 40mm Illuminated Pushlock Turn Reset 	Transformer	1NO-1NC AVLD3④11DNUR* 2NO AVLD3④20DNUR* 2NC AVLD3④02DNUR*
	Non-Illuminated	1NO AYD310NU⑤ 1NC AYD301NU⑤ 1NO-1NC AYD311NU⑤ 2NO AYD320NU⑤ 2NC AYD302NU⑤
ø 40mm Push-Pull 	Full Voltage	1NO-1NC AYLD3③11DNU② ** 2NO AYLD3③20DNU② ** 2NC AYLD3③02DNU② **
	Transformer	1NO-1NC AYLD3④11DNU② ** 2NO AYLD3④20DNU② ** 2NC AYLD3④02DNU② **

- 1. In place of ①, specify the button color code
- 2. In place of ②, specify the lens color code.
- 3. In place of ③, specify the Full Voltage (lamp voltage) Code.
- 4. * Only available in red.
- 5. In place of ④, specify the transformer voltage code.
- 6. **Not available in blue.
- 7. For sub-assembly part numbers, see next page.
- 8. For nameplates and accessories, see page 767 and page 765.
- 9. For dimensions, see page 770.

① Button Color Codes

Color	Code
Black	B
Green	G
Red	R
Blue	S
Yellow	Y

② Lens Color Codes

Color	Code
Amber	A
Green	G
Red	R
Blue	S
White	W
Yellow	Y

③ Full Voltage Codes

Voltage	Code
6V AC/DC	66
12V AC/DC	11
24V AC/DC	22
120V AC	QH2
240V AC	QM4

④ Transformer Voltage Codes

Voltage	Code
120VAC	126
240VAC	246
480VAC	486

 Transformers step down to 6V.

Stop Switches (Sub-Assembled)

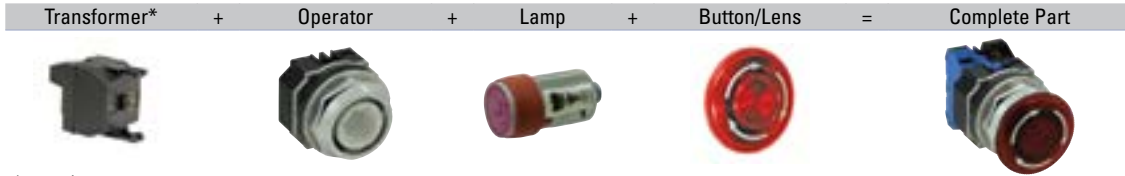



* Not required for full voltage units.

Operators



Style	Part Number
 ø40mm Illuminated and Non-illuminated Pushlock Turn Reset	AVD000T8
 ø 40mm Illuminated and Non-illuminated Push-Pull	AYD000T8

Buttons and Lenses

Style	Part Number
 Button for Pushlock Turn Reset Stop Switches (ø40mm, red only)	AVN3B-R
 Lens for Illuminated Pushlock Turn Reset Stop Switches (ø40mm, red only)	AVLN3LU-R
 Button for Push-Pull Stop Switches (ø40mm)	AYD3BN-①
 Lens for Illuminated Push-Pull Stop Switches (ø40mm)	AYLD3L-② 2 pos*

- ① In place of ①, specify the Button Color Code. (See table below)
- ② In place of ②, specify the LED Color Code.
- ③ *Not available in blue.

Lamp Circuit Components

Style	Application	Part Number
 Long Lamp Holder	Used with Full-size Transformer and two contact blocks Used with Full Voltage Adaptor and two contact blocks	TW-LH2
 Lead Holder	Used with TW-LH2 holder when using four contact blocks	HW-LH3

Lamps

Style	Voltage	Part Number
 LED	6V AC/DC	LSTD-6③
	12V AC/DC	LSTD-1③
	24V AC/DC	LSTD-2③
	120V AC	LSTD-H2③
	240V AC	LSTD-M4③

- ① In place of ②, specify the LED color code.
- ② The LED contains a current-limiting resistor and a protection diode.

① Button Color Codes

Color	Code
Black	B
Green	G
Red	R
Blue	S
Yellow	Y

② Lens Color Codes

Color	Code
Amber	A
Green	G
Red	R
Blue	S
White	W

③ LED Color Codes

Color	Code
Amber	A
Green	G
Red	R
Blue	S
White	W

Contact Blocks

Style	Part Number	
	1NO	1NC
 All Control Units	HW-U10-F	HW-U01-F
	HW-U10R-F (early make)	HW-U01R-F (late break)
 Dummy Block	HW-DB	



- ① Dummy blocks (no contacts) are used with an odd number of contact blocks.
- ② Combining HW-U10R-F and HW-U01R-F result in overlapping contacts.

Transformers

Style	Primary Voltage (50/60Hz)	Part Number
	120V AC	TW-F126B
	240V AC	TW-F246B
	480V AC	HW-L486

① 6V secondary voltage (uses 6V LED).

Full Voltage Modules

Style	Description	Part Number
 Dummy Block with Full Voltage Adaptor	For use with odd number of contacts. Finger-Safe	HW-DA1FBN
 Full Voltage Adaptor	For use with even number of contacts. Finger-Safe	TW-DA1FB

① All Transformers step down to 6V (use 6V lamp).

Pilot Lights (Assembled)



Assembled Pilot Lights

A P D 1 126 D NU R

Function _____
P: Pilot Light

Series Designation _____
D: TWND Series

Lens Shape _____
1: Dome

Rated Operational Voltage (Primary) _____

Transformer Type	Full Voltage Type
126: 120V AC	66: 6VAC/DC
246: 240V AC	11: 12VAC/DC
486: 480V AC	22: 24VAC/DC
	QH2: 120VAC
	QM4: 240VAC

Lens Color Code

A:	Amber
G:	Green
R:	Red
S:	Blue
W:	White
Y:	Yellow

D: LED

Use only when interpreting part numbers. Do not use for developing part numbers.

LED Pilot Lights

Style	Operating Voltage	Part Number
		LED
Transformer Dome 	120V AC	APD1126DNU ^②
	240V AC	APD1246DNU ^②
	480V AC	APD1486DNU ^②
	—	APD1 ^③ DNU ^②
Full Voltage Dome 	—	APD1 ^③ DNU ^②

- 1. In place of ^②, specify the Lens/LED Color Code.
- 2. In place of ^③, specify the Full Voltage Code (LED voltage).
- 3. Yellow pilot light comes with white LED.

② Lens Color Codes

Color	Code
Amber	A
Green	G
Red	R
Blue	S
White	W
Yellow	Y

③ Full Voltage Codes

Voltage	Code
6V AC/DC	66
12V AC/DC	11
24V AC/DC	22
120V AC	QH2
240V AC	QM4

Pilot Lights (Sub-Assembled)

Transformer* + Operator + Lamp + Lens = Complete Part



* Not required for full voltage units.

One Each from Left Column plus **One Selection from Right Column**

Operators

Style	Part Number
Transformer or FULL Voltage	APD09ST8

Full Voltage Clips

Primary Voltage (50/60Hz)	Part Number
	APD-F

Required for all full voltage models. Two pieces each. 2 clips required for full voltage pilot lights

Lenses

Style	Part Number
Dome Lens	APN106LN-②

1. In place of ②, specify the Lens Color Code.

Transformers (only for Pilot Lights)

Style	Primary Voltage (50/60Hz)	Part Number
LED	120V AC	TWD-0126
	240V AC	TWD-0246
	480V AC	TWD-0486

6V secondary voltage (use 6V lamp).

Lamps

Style	Voltage	Part Number
LED	6V AC/DC	LSTD-6③
	12V AC/DC	LSTD-1③
	24V AC/DC	LSTD-2③
	120V AC	LSTD-H2③
	240V AC	LSTD-M4③

1. In place of ②, specify the LED color code.
2. The LED contains a current-limiting resistor and a protection diode.

② Lens Color Codes

Color	Code
Amber	A
Green	G
Red	R
Blue	S
White	W
Yellow	Y

③ LED Color Codes

Color	Code
Amber	A
Green	G
Red	R
Blue	S
White	W

Yellow LED not available, use white LED with Yellow lens.

Illuminated Pushbuttons (Assembled)

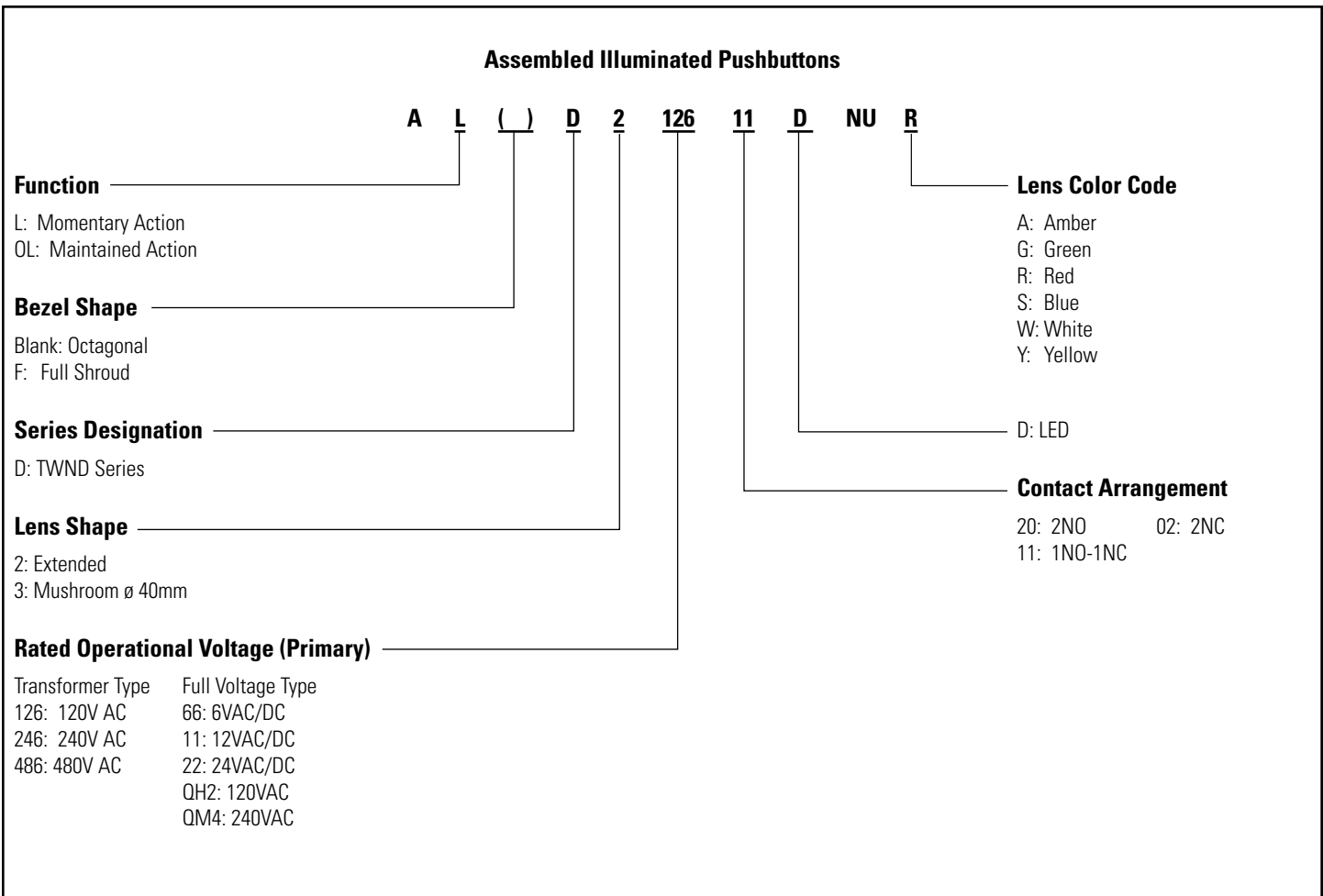

1. Use only when interpreting part numbers. Do not use for developing part numbers.
2. All transformers step down to 6V.

Illuminated Pushbuttons (Assembled)

Illuminated Pushbuttons

Style	Contacts	Part Number		
		Momentary	Maintained	
Extended Lens 	Full Voltage	1NO-1NC 2NO 2NC	ALD2Ⓞ11DNUⓄ ALD2Ⓞ20DNUⓄ ALD2Ⓞ02DNUⓄ	AOLD2Ⓞ11DNUⓄ AOLD2Ⓞ20DNUⓄ AOLD2Ⓞ02DNUⓄ
	Transformer	1NO-1NC 2NO 2NC	ALD2 ⊕ 11DNUⓄ ALD2 ⊕ 20DNUⓄ ALD2 ⊕ 02DNUⓄ	AOLD2 ⊕ 11DNUⓄ AOLD2 ⊕ 20DNUⓄ AOLD2 ⊕ 02DNUⓄ
Extended Lens with Full Shroud 	Full Voltage	1NO-1NC 2NO 2NC	ALFD2Ⓞ11DNUⓄ ALFD2Ⓞ20DNUⓄ ALFD2Ⓞ02DNUⓄ	AOLFD2Ⓞ11DNUⓄ AOLFD2Ⓞ20DNUⓄ AOLFD2Ⓞ02DNUⓄ
	Transformer	1NO-1NC 2NO 2NC	ALFD2 ⊕ 11DNUⓄ ALFD2 ⊕ 20DNUⓄ ALFD2 ⊕ 02DNUⓄ	AOLFD2 ⊕ 11DNUⓄ AOLFD2 ⊕ 20DNUⓄ AOLFD2 ⊕ 02DNUⓄ
ø 40mm Mushroom Lens 	Full Voltage	1NO-1NC 2NO 2NC	ALD3Ⓞ11DNUⓄ ALD3Ⓞ20DNUⓄ ALD3Ⓞ02DNUⓄ	AOLD3Ⓞ11DNUⓄ AOLD3Ⓞ20DNUⓄ AOLD3Ⓞ02DNUⓄ
	Transformer	1NO-1NC 2NO 2NC	ALD3 ⊕ 11DNUⓄ ALD3 ⊕ 20DNUⓄ ALD3 ⊕ 02DNUⓄ	AOLD3 ⊕ 11DNUⓄ AOLD3 ⊕ 20DNUⓄ AOLD3 ⊕ 02DNUⓄ

② Lens Color Codes

Color	Code
Amber	A
Green	G
Red	R
Blue	S
White	W
Yellow	Y

③ Full Voltage Codes

Voltage	Code
6V AC/DC	66
12V AC/DC	11
24V AC/DC	22
120V AC	QH2
240V AC	QM4

④ Transformer Voltage Codes

Voltage	Code
120VAC	126
240VAC	246
480VAC	486

 6V secondary voltage (uses 6V LED).

- 1. In place of Ⓞ, specify the Lens Color Code.
- 2. In place of Ⓞ, specify the Full Voltage Code (LED voltage).
- 3. In place of ⊕, specify the Transformer Voltage Code.
- 4. Light is independent of switch position.
- 5. Yellow pushbutton comes with white LED only.

Illuminated Pushbuttons (Sub-Assembled)

Transformer* + Contact Block + Operator + LED + Lens = Complete Part



*Not required for full voltage types.

Operators

Style	Image	Part Number	
		Momentary	Maintained
Extended		ALD2300T8	AOLD2300T8
Extended with Full Shroud		ALFD2300T8	AOLFD2300T8
40mm Mushroom		ALD2300T8	AOLD2300T8

Lenses

Style	Image	Part Number
Extended		ALN06LU-Ⓞ
ø 40mm Mushroom		ALN3LU-Ⓞ

In place of Ⓞ, specify the Lens Color Code.

Lamp Circuit Components

Style	Application	Part Number
Long Lamp Holder 	Used with Full-size Transformer and two contact blocks Used with Full Voltage Adaptor and two contact blocks	TW-LH2
Lead Holder 	Used with TW-LH2 holder when using four contact blocks	HW-LH3

Lamps

Style	Voltage	Part Number
	6V AC/DC	LSTD-6Ⓞ
	12V AC/DC	LSTD-1Ⓞ
	24V AC/DC	LSTD-2Ⓞ
	120V AC	LSTD-H2Ⓞ
	240V AC	LSTD-M4Ⓞ

1. In place of Ⓞ, specify the LED color code.
2. The LED contains a current-limiting resistor and a protection diode.

Ⓞ Lens Color Codes

Color	Code
Amber	A
Green	G
Red	R
Blue	S
White	W
Yellow	Y

Ⓞ LED Color Codes

Color	Code
Amber	A
Green	G
Red	R
Blue	S
White	W

Yellow lens only. Yellow LED not available, use white LED.

Contact Blocks

Style	Image	Part Number	
		1NO	1NC
All Control Units		HW-U10-F	HW-U01-F
		HW-U10R-F (early make)	HW-U01R-F (late break)
Dummy Block		HW-DB	

1. Dummy blocks (no contacts) are used with an odd number of contact blocks.
2. Combining HW-U10R-F and HW-U01R-F result in overlapping contacts (remain on, or closed, when switch is moved between two positions).

Transformers

Style	Primary Voltage (50/60Hz)	Part Number
	120V AC	TW-F126B
	240V AC	TW-F246B
	480V AC	HW-L486

6V secondary voltage (use 6V LED).

Full Voltage Modules

Style	Description	Part Number
Dummy Block with Full Voltage Adaptor 	For use with odd number of contacts. Finger-Safe	HW-DA1FBN
Full Voltage Adaptor 	For use with even number of contacts. Finger-Safe	TW-DA1FB

All Transformers step down to 6V (use 6V lamp).

Non-Illuminated Selector Switches (Assembled)



Assembled Selector Switches

A S D 2 () () 11 NU - ()

Function

S: Selector Switch

Series Designation

D: TWND Series

Number of Positions

2: 2-Position
3: 3-Position

Spring Return Action

Blank: Maintained
1: Spring return from Right
2: Spring return from Left
3: 2-Way spring return from Left and Right

Circuit Number

(See Circuit # column of Selector Switch Contact Arrangement Chart on beginning on page 762.)

Contact Arrangement Code

10: 1NO 01: 1NC
20: 2NO 02: 2NC
40: 4NO 04: 4NC
11: 1NO-1NC 22: 2NO-2NC



Operator Style Code

Blank: Knob Operator
L: Lever Operator
K: Key Operator

- 1. Use only when interpreting part numbers. Do not use for developing part numbers.
- 2. Custom key removal codes available. Please contact IDEC for details.

Non-Illuminated Selector Switches (Assembled)





Non-Illuminated 2-Position Selector Switches

Style					Part Number		
Contact	Mounting	Operator Position			Maintained	Spring Return from Right	Spring Return from Left
		L	R				
1NO	1	0	X	Knob Lever Key	ASD210NU	ASD2110NU	ASD2210NU
	2	0	0		ASD2L10NU	ASD21L10NU	ASD22L10NU
					ASD2K10NU	ASD21K10NU	ASD22K10NU
1NC	1	X	0	Knob Lever Key	ASD201NU	ASD2101NU	ASD2201NU
	2	0	0		ASD2L01NU	ASD21L01NU	ASD22L01NU
					ASD2K01NU	ASD21K01NU	ASD22K01NU
1NO 1NC	1	0	X	Knob Lever Key	ASD211NU	ASD2111NU	ASD2211NU
	2	X	0		ASD2L11NU	ASD21L11NU	ASD22L11NU
					ASD2K11NU	ASD21K11NU	ASD22K11NU
2NO	1	0	X	Knob Lever Key	ASD220NU	ASD2120NU	ASD2220NU
	2	0	X		ASD2L20NU	ASD21L20NU	ASD22L20NU
					ASD2K20NU	ASD21K20NU	ASD22K20NU
2NC	1	X	0	Knob Lever Key	ASD202NU	ASD2102NU	ASD2202NU
	2	X	0		ASD2L02NU	ASD21L02NU	ASD22L02NU
					ASD2K02NU	ASD21K02NU	ASD22K02NU
2NO 2NC	1	0	X	Knob Lever Key	ASD222NU	ASD2122NU	ASD2222NU
	2	X	0		ASD2L22NU	ASD21L22NU	ASD22L22NU
	3	0	X		ASD2K22NU	ASD21K22NU	ASD22K22NU
	4	X	0				
2NO 2NC	1	0	X	Knob Lever Key	ASD222NU-111	ASD2122NU-111	ASD2222NU-111
	2	0	X		ASD2L22NU-111	ASD21L22NU-111	ASD22L22NU-111
	3	X	0		ASD2K22NU-111	ASD21K22NU-111	ASD22K22NU-111
	4	X	0				



- The truth table indicates the operating position of contact block when the operator is switched to that position.
X = On (closed contacts) 0 = Off (open contacts)
X-X = Overlapping Contacts: Remain on (closed contacts) when switch is moved between these two positions.
- All knob and lever selector switches come in black. Other colors are available by ordering the knob or lever separately.
- Custom contact arrangements available, see page 762.

Non-Illuminated 3-Position Selector Switches

Style						Part Number			
Contact	Mounting	Operator Position				Maintained	Spring Return from Right	Spring Return from Left	Spring Return Two-Way
		L	C	R					
2NO	1	X	0	0	Knob Lever Key	ASD320NU	ASD3120NU	ASD3220NU	ASD3320NU
	2	0	0	X		ASD3L20NU	ASD31L20NU	ASD32L20NU	ASD33L20NU
						ASD3K20NU	ASD31K20NU	ASD32K20NU	ASD33K20NU
2NC	1	0	X	X	Knob Lever Key	ASD302NU	ASD3102NU	ASD3202NU	ASD3302NU
	2	X	X	0		ASD3L02NU	ASD31L02NU	ASD32L02NU	ASD33L02NU
						ASD3K02NU	ASD31K02NU	ASD32K02NU	ASD33K02NU
2NO 2NC	1	X	0	0	Knob Lever Key	ASD322NU	ASD3122NU	ASD3222NU	ASD3322NU
	2	0	0	X		ASD3L22NU	ASD31L22NU	ASD32L22NU	ASD33L22NU
	3	0	X	X		ASD3K22NU	ASD31K22NU	ASD32K22NU	ASD33K22NU
	4	X	X	0					
2NO 2NC	1	X	0	X	Knob Lever Key	ASD322NU-309	ASD3122NU-309	ASD3222NU-309	ASD3322NU-309
	2	X	X	0		ASD3L22NU-309	ASD31L22NU-309	ASD32L22NU-309	ASD33L22NU-309
	3	0	X	0		ASD3K22NU-309	ASD31K22NU-309	ASD32K22NU-309	ASD33K22NU-309
	4	0	0	X					
2NO 2NC	1	0	X	0	Knob Lever Key	ASD322NU-310	ASD3122NU-310	ASD3222NU-310	ASD3322NU-310
	2	0	0	X		ASD3L22NU-310	ASD31L22NU-310	ASD32L22NU-310	ASD33L22NU-310
	3	0	X	0		ASD3K22NU-310	ASD31K22NU-310	ASD32K22NU-310	ASD33K22NU-310
	4	0	0	X					
4NO	1	X	0	0	Knob Lever Key	ASD340NU	ASD3140NU	ASD3240NU	ASD3340NU
	2	0	0	X		ASD3L40NU	ASD31L40NU	ASD32L40NU	ASD33L40NU
	3	X	0	0		ASD3K40NU	ASD31K40NU	ASD32K40NU	ASD33K40NU
	4	0	0	X					
4NC	1	0	X	X	Knob Lever Key	ASD304NU	ASD3104NU	ASD3204NU	ASD3304NU
	2	X	X	0		ASD3L04NU	ASD31L04NU	ASD32L04NU	ASD33L04NU
	3	0	X	X		ASD3K04NU	ASD31K04NU	ASD32K04NU	ASD33K04NU
	4	X	X	0					

Non-Illuminated Selector Switches (Sub-Assembled)

Contact Blocks + Operator + Knob or Lever* + Color Insert* = Complete Part†



- 1. *Not needed with key type switches.
- 2. †Knob type shown.

Operators

Style	Position	Description	Part Number	
 Knob/Lever	2	Maintained	ASD0201T8	
		Spring return from right	ASD0213T8	
		Spring return from left	ASD0224T8	
	3	Maintained, Cam 1 Maintained, Cam 2		ASD0302T8 ASD0306T8
			Spring return from right, Cam 1 Spring return from right, Cam 2	ASD0314T8 ASD0310T8
		Spring return from left, Cam 1 Spring return from left, Cam 2		ASD0323T8 ASD0328T8
Spring return from left/right, Cam 1 Spring return from left/right, Cam 2			ASD0335T8 ASD0339T8	
 Key		2	Maintained	ASD0201KT8
			Spring return from right	ASD0213KT8
	Spring return from left		ASD0224KT8	
	3	Maintained, Cam 1 Maintained, Cam 2		ASD0302KT8 ASD0306KT8
			Spring return from right, Cam 1 Spring return from right, Cam 2	ASD0302KT8B ASD0310KT8B
		Spring return from left, Cam 1 Spring return from left, Cam 2		ASD0323KT8 ASD0310KT8B
Spring return from left/right, Cam 1 Spring return from left/right, Cam 2			ASD0335KT8 ASD3K339KT8	



- 1. Order knobs, levers, color inserts separately (see below).
- 2. For key switches, keys are removable in all maintained positions. Other options available, contact IDEC for details.
- 3. See page 764 "Operator Truth Tables" for details of difference between cams.

① Color Codes

Knob/Lever Color	Code
Black	B
Blue	S
Green	G
Red	R
Yellow	Y
White	W

- 1. Knob/Lever not available in white.
- 2. Color inserts not available in Black.
- 3. Lever not available in yellow.

Handles and Inserts

Style	Part Number
 Knob	ASDHHY-①
 Lever	ASDHHL-①*
 Color Insert	TW-HC1-①

- 1. In place of ①, specify the Color Code.
*Not available in yellow.

Contact Blocks

Style	Part Number	
	1NO	1NC
 All Control Units	HW-U10-F HW-U10R-F (early make)	HW-U01-F HW-U01R-F (late break)
 Dummy Block	HW-DB	

- 1. Dummy blocks (no contacts) are used with an odd number of contact blocks.
- 2. Combining HW-U10R-F and HW-U01R-F result in overlapping contacts (remain on, or closed, when switch is moved between two positions).

Illuminated Selector Switches (Assembled)



Assembled Illuminated Selector Switches

A SL D 2 (2) 22 11 DN U - 111 - R

Function

SL: Illuminated Selector Switch

Series Designation

D: TWND series

Number of Positions

2: 2-Position
3: 3-Position

Spring Return Action

Blank: Maintained
1: Spring return from Right
2: Spring return from Left
3: Two-Way spring return from Left and Right

Rated Operational Voltage (Primary)

Transformer Type	Full Voltage Type
136: 120V AC	66: 6VAC/DC
256: 240V AC	11: 12VAC/DC
486: 480V AC	22: 24VAC/DC
	QH2: 120VAC
	QM4: 240VAC

Contact Arrangement Code

20: 2NO 02: 2NC
40: 4NO 04: 4NC
11: 1NO-1NC 22: 2NO-2NC

Lens Color Code

A: Amber
G: Green
R: Red
S: Blue
W: White
Y: Yellow

Circuit Code Number

See Circuit # column of Selector Switch Contact Arrangement Charts on page 762.

D: LED Lamp



Use only when interpreting part numbers. Do not use for developing part numbers.

Illuminated Selector Switches (Assembled)

Illuminated 2-Position Selector Switches

Style					Part Number		
Contact	Mounting	Operator Position		Lamp Circuit Type	Maintained	Spring Return from Right	Spring Return from Left
		L	R				
1NO	1	0	X	Transformer Full Voltage	ASLD2 ④11DNU② ASLD2③11DNU②	ASLD21 ④11DNU② ASLD21③11DNU②	ASLD22 ④11DNU② ASLD22③11DNU②
1NC	2	X	0				
2NO	1	0	X	Transformer Full Voltage	ASLD2 ④20DNU② ASLD2③20DNU②	ASLD21 ④20DNU② ASLD21③20DNU②	ASLD22 ④20DNU② ASLD22③20DNU②
2NC	2	0	X				
2NO	1	X	0	Transformer Full Voltage	ASLD2 ④02DNU-② ASLD2③02DNU-104-②	ASLD21 ④02DNU-② ASLD21③02DNU-②	ASLD22 ④02DNU-② ASLD22③02DNU-②
2NC	2	X	0				
2NO	1	0	X	Transformer Full Voltage	ASLD2 ④22DNU② ASLD2③22DNU②	ASLD21 ④22DNU② ASLD21③22DNU②	ASLD22 ④22DNU② ASLD22③22DNU②
2NC	2	X	0				
2NC	3	0	X				
2NC	4	X	0				
2NO	1	0	X	Transformer Full Voltage	ASLD2 ④22DNU-111-② ASLD2③22DNU-111-②	ASLD21 ④22DNU-111-② ASLD21③22DNU-111-②	ASLD22 ④22DNU-111-② ASLD22③22DNU-111-②
2NC	2	0	X				
2NC	3	X	0				
2NC	4	X	0				

② Lens Color Codes

Color	Code
Amber	A
Green	G
Red	R
Blue	S
White	W
Yellow	Y

③ Full Voltage Codes

Voltage	Code
6V AC/DC	66
12V AC/DC	11
24V AC/DC	22
120V AC	QH2
240V AC	QM4

Illuminated 3-Position Selector Switches, Maintained and Spring Return

Style					Part Number				
Contact	Mounting	Operator Position			Lamp Circuit Type	Maintained	Spring Return From Right	Spring Return from Left	Spring Return Two-Way
		L	C	R					
2NO	1	X	0	0	Transformer Full Voltage	ASLD3 ④ 20DNU② ASLD3③20DNU②	ASLD31 ④ 20DNU② ASLD31③20DNU②	ASLD32 ④ 20DNU② ASLD32③20DNU②	ASLD33 ④ 20DNU② ASLD33③20DNU②
2NC	2	0	0	X					
2NC	1	0	X	X	Transformer Full Voltage	ASLD3 ④ 02DNU② ASLD3③02DNU②	ASLD31 ④ 02DNU② ASLD31③02DNU②	ASLD32 ④ 02DNU② ASLD32③02DNU②	ASLD33 ④ 02DNU② ASLD33③02DNU②
2NC	2	X	X	0					
2NO	1	X	0	0	Transformer Full Voltage	ASLD3 ④ 22DNU② ASLD3③22DNU②	ASLD31 ④ 22DNU② ASLD31③22DNU②	ASLD32 ④ 22DNU② ASLD32③22DNU②	ASLD33 ④ 22DNU② ASLD33③22DNU②
2NC	2	0	0	X					
2NC	3	0	X	X					
2NC	4	X	X	0					
2NO	1	X	0	X	Transformer Full Voltage	ASLD3 ④ 22DNU-309-② ASLD3③22DNU-309-②	ASLD31 ④ 22DNU-309-② ASLD31③22DNU-309-②	ASLD32 ④ 22DNU-309-② ASLD32③22DNU-309-②	ASLD33 ④ 22DNU-309-② ASLD33③22DNU-309-②
2NC	2	X	X	0					
2NC	3	0	X	0					
2NC	4	0	0	X					
2NO	1	0	X	0	Transformer Full Voltage	ASLD3 ④ 22DNU-310-② ASLD3③22DNU-310-②	ASLD31 ④ 22DNU-310-② ASLD31③22DNU-310-②	ASLD32 ④ 22DNU-310-② ASLD32③22DNU-310-②	ASLD33 ④ 22DNU-310-② ASLD33③22DNU-310-②
2NC	2	0	0	X					
2NC	3	0	X	0					
2NC	4	0	0	X					
4NO	1	X	0	0	Transformer Full Voltage	ASLD3 ④ 40DNU② ASLD3③40DNU②	ASLD31 ④ 40DNU② ASLD31③40DNU②	ASLD32 ④ 40DNU② ASLD32③40DNU②	ASLD33 ④ 40DNU② ASLD33③40DNU②
4NO	2	0	0	X					
4NO	3	X	0	0					
4NO	4	0	0	X					
4NC	1	0	X	X	Transformer Full Voltage	ASLD3 ④ 04DNU② ASLD3③04DNU②	ASLD31 ④ 04DNU② ASLD31③04DNU②	ASLD32 ④ 04DNU② ASLD32③04DNU②	ASLD33 ④ 04DNU② ASLD33③04DNU②
4NC	2	X	X	0					
4NC	3	0	X	X					
4NC	4	X	X	0					

- In place of ②, specify the Lens/LED Color Code, in place of ③, specify the Full Voltage (LED voltage) Code, in place of ④, specify the Transformer Voltage Code.
- The truth table indicates the operating position of contact block when the operator is switched to that position.
X = On (Closed Contacts) 0 = Off (Open Contacts)
X-X = Overlapping Contacts: Remain on (closed contacts) when switch is moved between these positions
- Yellow selector switch comes with white LED.

④ Transformer Voltage Codes

Voltage	Code
120VAC	136
240VAC	256
480VAC	486

Transformers step down to 6V (use 6V LED).

Illuminated Selector Switches (Sub-Assembled)



*Not required for full voltage units.

Operators

Style	Position	Description	Part Number
Operator 	2	Maintained	ASLD0201T8
	3	Maintained, Cam 1	ASLD0302T8
		Maintained, Cam 2	ASLD0306T8
	2	Spring return from right	ASLD0213T8
		Spring return from left	ASLD0224T8
	3	Spring return from right, Cam 1	ASLD0314T8
		Spring return from right, Cam 2	ASLD0310T8
		Spring return from left, Cam 1	ASLD0323T8
		Spring return from left, Cam 2	ASLD0328T8
		Spring return from left/right, Cam 1	ASLD0335T8
Spring return from left/right, Cam 2		ASLD0339T8	

Lamp Circuit Components

Style	Application	Part Number
Long Lamp Holder 	Used with Full-size Transformer and two contact blocks	TW-LH2
Lead Holder 	Used with Full Voltage Adaptor and two contact blocks	
	Used with TW-LH2 holder when using four contact blocks	HW-LH3

Full Voltage Modules

Style	Description	Part Number
Dummy Block with Full Voltage Adaptor 	For use with odd number of contacts. Finger-Safe	HW-DA1FBN
Full Voltage Adaptor 	For use with even number of contacts. Finger-Safe	TW-DA1FB



All Transformers step down to 6V (use 6V lamp).

Transformers

Style	Primary Voltage (50/60Hz)	Part Number
Transformers 	120V AC	TW-F126B
	240V AC	TW-F126B
	480V AC	HW-L486



6V secondary voltage.

Lenses

Style	Part Number
Knob 	ASLNHU-③ ②

Lamps

Style	Voltage	Part Number
LED 	6V AC/DC	LSTD-6③
	12V AC/DC	LSTD-1③
	24V AC/DC	LSTD-2③
	120V AC	LSTD-H2③
	240V AC	LSTD-M4③



- In place of ②, specify the LED color code.
- The LED contains a current-limiting resistor and a protection diode.

Contact Blocks

Style	Part Number	
	1NO	1NC
All Control Units 	HW-U10-F	HW-U10-F
	HW-U10R-F (early make)	HW-U10R-F (late break)
Dummy Block 	HW-DB	



- Dummy blocks (no contacts) are used with an odd number of contact blocks.
- Combining HW-U10R-F and HW-U01R-F result in overlapping contacts (remain on, or closed, when switch is moved between two positions).

② Lens Color Codes

Color	Code
Amber	A
Green	G
Red	R
Blue	S
White	W
Yellow	Y

③ LED Color Codes

Color	Code
Amber	A
Green	G
Red	R
Blue	S
White	W



Yellow lens only. Yellow LED not available, use white LED.

Contact Arrangement Charts

How to Read Contact Arrangement Charts

To determine contact block mounting position, first make sure the selector switch is oriented as shown on the right

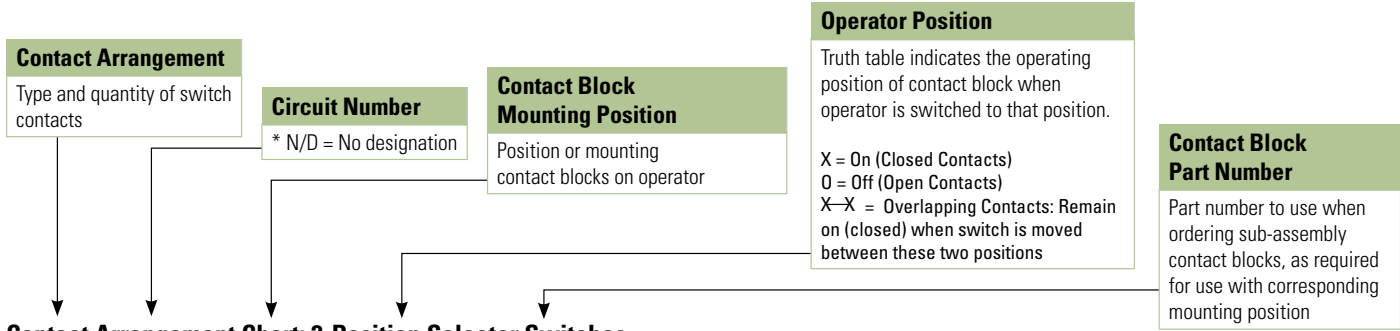

Contact Arrangement Chart: 2-Position Selector Switches

Style		Mounting Position	Operator Position		Contact Block Part Number	Description	Operator Part Number		
Contact	Circuit Number		L	R			Maintained	Spring Return from Right	Spring Return from Left
1NO	N/D	1	0	X	HW-U10-F	Knob/Lever Key	ASD0201T8 ASD0201KT8	ASD0213T8 ASD0213KT8	ASD0224T8 ASD0224KT8
		2	0	0	HW-DB	Illuminated Knob	ASLD0201T8	ASLD0213T8	ASLD0224T8
1NC	N/D	1	X	0	HW-U01-F	Knob/Lever Key	ASD0201T8 ASD0201KT8	ASD0213T8 ASD0213KT8	ASD0224T8 ASD0224KT8
		2	0	0	HW-DB	Illuminated Knob	ASLD0201T8	ASLD0213T8	ASLD0224T8
1NO 1NC	N/D	1	0	X	HW-U10-F	Knob/Lever Key	ASD0201T8 ASD0201KT8	ASD0213T8 ASD0213KT8	ASD0224T8 ASD0224KT8
		2	X	0	HW-U01-F	Illuminated Knob	ASLD0201T8	ASLD0213T8	ASLD0224T8
	103	1	X	0	HW-U01-F	Knob/Lever Key	ASD0201T8 ASD0201KT8	ASD0213T8 ASD0213KT8	ASD0224T8 ASD0224KT8
		2	0	X	HW-U10-F	Illuminated Knob	ASLD0201T8	ASLD0213T8	ASLD0224T8
1NO-EM 1NC-LB	600	1	0	X	HW-U10R-F	Knob/Lever Key	ASD0201T8 ASD0201KT8	ASD0213T8 ASD0213KT8	ASD0224T8 ASD0224KT8
		2	X	0	HW-U01R-F	Illuminated Knob	ASLD0201T8	ASLD0213T8	ASLD0224T8
	601	1	X	0	HW-U01R-F	Knob/Lever Key	ASD0201T8 ASD0201KT8	ASD0213T8 ASD0213KT8	ASD0224T8 ASD0224KT8
		2	0	X	HW-U10R-F	Illuminated Knob	ASLD0201T8	ASLD0213T8	ASLD0224T8
2NO	N/D	1	0	X	HW-U10-F	Knob/Lever Key	ASD0201T8 ASD0201KT8	ASD0213T8 ASD0213KT8	ASD0224T8 ASD0224KT8
		2	0	X	HW-U10-F	Illuminated Knob	ASLD0201T8	ASLD0213T8	ASLD0224T8
2NC	N/D	1	X	0	HW-U01-F	Knob/Lever Key	ASD0201T8 ASD0201KT8	ASD0213T8 ASD0213KT8	ASD0224T8 ASD0224KT8
		2	X	0	HW-U01-F	Illuminated Knob	ASLD0201T8	ASLD0213T8	ASLD0224T8
2NO 2NC	N/D	1	0	X	HW-U10-F	Knob/Lever Key	ASD0201T8	ASD0213T8	ASD0224T8
		2	X	0	HW-U01-F	Illuminated Knob	ASD0201KT8	ASD0213KT8	ASD0224KT8
		3	0	X	HW-U10-F	Illuminated Knob	ASLD0201T8	ASLD0213T8	ASLD0224T8
		4	X	0	HW-U01-F	Illuminated Knob	ASLD0201T8	ASLD0213T8	ASLD0224T8
	110	1	X	0	HW-U01-F	Knob/Lever Key	ASD0201T8	ASD0213T8	ASD0224T8
		2	0	X	HW-U10-F	Illuminated Knob	ASD0201KT8	ASD0213KT8	ASD0224KT8
		3	X	0	HW-U01-F	Illuminated Knob	ASLD0201T8	ASLD0213T8	ASLD0224T8
		4	0	X	HW-U10-F	Illuminated Knob	ASLD0201T8	ASLD0213T8	ASLD0224T8
111	1	0	X	HW-U10-F	Knob/Lever Key	ASD0201T8	ASD0213T8	ASD0224T8	
	2	0	X	HW-U10-F	Illuminated Knob	ASD0201KT8	ASD0213KT8	ASD0224KT8	
	3	X	0	HW-U01-F	Illuminated Knob	ASLD0201T8	ASLD0213T8	ASLD0224T8	
	4	X	0	HW-U01-F	Illuminated Knob	ASLD0201T8	ASLD0213T8	ASLD0224T8	
4NO	N/D	1	0	X	HW-U10-F	Knob/Lever Key	ASD0201T8	ASD0213T8	ASD0224T8
		2	0	X	HW-U10-F	Illuminated Knob	ASD0201KT8	ASD0213KT8	ASD0224KT8
		3	0	X	HW-U10-F	Illuminated Knob	ASLD0201T8	ASLD0213T8	ASLD0224T8
		4	0	X	HW-U10-F	Illuminated Knob	ASLD0201T8	ASLD0213T8	ASLD0224T8

Contact Arrangement Chart: 3-Position Selector Switches

Style		Mounting Position	Operator Position			Contact Block Part Number	Description	Operator Part Number			
Contact	Circuit Number		L	C	R			Maintained	Spring Return from Right	Spring Return from Left	Two-Way
1NO 1NC	202	1	X	0	0	HW-U10-F	Knob/Lever Key	ASD0302T8 ASD0302KT8	ASD0314T8 ASD0314KT8	ASD0323T8 ASD0323KT8	ASD0335T8 ASD0335KT8
		2	X—X	0	0	HW-U01-F	Illuminated Knob	ASLD0302T8	ASLD0314T8	ASLD0323T8	ASLD0335T8
	203	1	0	X—X	0	HW-U01-F	Knob/Lever Key	ASD0302T8 ASD0302KT8	ASD0314T8 ASD0314KT8	ASD0323T8 ASD0323KT8	ASD0335T8 ASD0335KT8
		2	0	0	X	HW-U10-F	Illuminated Knob	ASLD0302T8	ASLD0314T8	ASLD0323T8	ASLD0335T8
	302	1	X	0	X	HW-U10-F	Knob/Lever Key	ASD0306T8 ASD0306KT8	ASD0310T8 ASD0301KT8	ASD0328T8 ASD0328KT8	ASD0339T8 ASD0339KT8
		2	X—X	0	0	HW-U10-F	Illuminated Knob	ASLD0306T8	ASLD310T8	ASLD0328T8	ASLD0339T8
303	1	0	X	0	HW-U01-F	Knob/Lever Key	ASD0306T8 ASD0306KT8	ASD0310T8 ASD0301KT8	ASD0328T8 ASD0328KT8	ASD0339T8 ASD0339KT8	
	2	0	0	X	HW-U10-F	Illuminated Knob	ASLD0306T8	ASLD310T8	ASLD0323T8	ASLD0339T8	
2NO	N/D	1	X	0	0	HW-U10-F	Knob/Lever Key	ASD0302T8 ASD0302KT8	ASD0314T8 ASD0314KT8	ASD0323T8 ASD0323KT8	ASD0335T8 ASD0335KT8
		2	0	0	X	HW-U10-F	Illuminated Knob	ASLD0302T8	ASLD0314T8	ASLD0323T8	ASLD0335T8
	301	1	X	0	X	HW-U10-F	Knob/Lever Key	ASD0306T8 ASD0306KT8	ASD0310T8 ASD0301KT8	ASD0328T8 ASD0328KT8	ASD0339T8 ASD0339KT8
		2	0	0	X	HW-U10-F	Illuminated Knob	ASLD0306T8	ASLD310T8	ASLD0328T8	ASLD0339T8
2NC	304	1	0	X	0	HW-U01-F	Knob/Lever Key	ASD0306T8 ASD0306KT8	ASD0310T8 ASD0301KT8	ASD0328T8 ASD0328KT8	ASD0339T8 ASD0339KT8
		2	X—X	0	0	HW-U01-F	Illuminated Knob	ASLD0306T8	ASLD310T8	ASLD0328T8	ASLD0339T8
	N/D	1	0	X—X	0	HW-U01-F	Knob/Lever Key	ASD0302T8 ASD0302KT8	ASD0314T8 ASD0314KT8	ASD0323T8 ASD0323KT8	ASD0335T8 ASD0335KT8
		2	X—X	0	0	HW-U01-F	Illuminated Knob	ASLD0302T8	ASLD0314T8	ASLD0323T8	ASLD0335T8
2NO 2NC	N/D	1	X	0	0	HW-U10-F	Knob/Lever Key Illuminated Knob	ASD0302T8 ASD0302KT8 ASLD0302T8	ASD0314T8 ASD0314KT8 ASLD0314T8	ASD0323T8 ASD0323KT8 ASLD0323T8	ASD0335T8 ASD0335KT8 ASLD0335T8
		2	0	0	X	HW-U10-F					
		3	0	X—X	0	HW-U01-F					
		4	X—X	0	0	HW-U01-F					
	210	1	0	X—X	0	HW-U01-F	Knob/Lever Key Illuminated Knob	ASD0302T8 ASD0302KT8 ASLD0302T8	ASD0314T8 ASD0314KT8 ASLD0314T8	ASD0323T8 ASD0323KT8 ASLD0323T8	ASD0335T8 ASD0335KT8 ASLD0335T8
		2	0	0	X	HW-U10-F					
		3	0	X—X	0	HW-U01-F					
		4	0	0	X	HW-U10-F					
	308	1	X	0	X	HW-U10-F	Knob/Lever Key Illuminated Knob	ASD0306T8 ASD0306KT8 ASLD0306T8	ASD0310T8 ASD0301KT8 ASLD310T8	ASD0328T8 ASD0328KT8 ASLD0328T8	ASD0339T8 ASD0339KT8 ASLD0339T8
		2	X—X	0	0	HW-U01-F					
		3	X	0	X	HW-U10-F					
		4	X—X	0	0	HW-U01-F					
	309	1	X	0	X	HW-U10-F	Knob/Lever Key Illuminated Knob	ASD0306T8 ASD0306KT8 ASLD0306T8	ASD0310T8 ASD0301KT8 ASLD310T8	ASD0328T8 ASD0328KT8 ASLD0328T8	ASD0339T8 ASD0339KT8 ASLD0339T8
		2	X—X	0	0	HW-U01-F					
		3	0	X	0	HW-U01-F					
		4	0	0	X	HW-U10-F					
310	1	0	X	0	HW-U01-F	Knob/Lever Key Illuminated Knob	ASD0306T8 ASD0306KT8 ASLD0306T8	ASD0310T8 ASD0301KT8 ASLD310T8	ASD0328T8 ASD0328KT8 ASLD0328T8	ASD0339T8 ASD0339KT8 ASLD0339T8	
	2	0	0	X	HW-U10-F						
	3	0	X	0	HW-U01-F						
	4	0	0	X	HW-U10-F						

1. Each operator sub-assembly is available as an "02" and an "06" for 3-position selector switches. The internal cam of an "02" is different from that of an "06". This results in designated combinations of open and closed contacts in the various operator positions.
2. N/D = No circuit number designation required in assembled part number.
3. X = On (closed contacts) 0 = Off (open contacts). X—X Overlapping contacts remain on (closed) when switch is moved between these two positions.

Contact Arrangement Chart: 3-Position Selector Switches

Style		Mounting Position	Operator Position			Contact Block Part Number	Description	Operator Part Number			
Contact	Circuit Number		L	C	R			Maintained	Spring Return from Right	Spring Return from Left	Two-Way
4NO	N/D	1	X	0	0	HW-U10-F					
		2	0	0	X	HW-U10-F	Knob/Lever Key	ASD0302T8 ASD0302KT8 ASLD0302T8	ASD0314T8 ASD0314KT8 ASLD0314T8	ASD0323T8 ASD0323KT8 ASLD0323T8	ASD0335T8 ASD0335KT8 ASD0335T8
		3	X	0	0	HW-U10-F	Illuminated Knob				
		4	0	0	X	HW-U10-F					
	305	1	X	0	X	HW-U10-F					
		2	0	0	X	HW-U10-F	Knob/Lever Key	ASD0306T8 ASD0306KT8 ASLD0306T8	ASD0310T8 ASD0301KT8 ASLD0310T8	ASD0328T8 ASD0328KT8 ASLD0328T8	ASD0339T8 ASD0339KT8 ASLD0339T8
		3	X	0	X	HW-U10-F	Illuminated Knob				
		4	0	0	X	HW-U10-F					
4NC	N/D	1	0	X	X	HW-U01-F					
		2	X	X	0	HW-U01-F	Knob/Lever Key	ASD0302T8 ASD0302KT8 ASLD0302T8	ASD0314T8 ASD0314KT8 ASLD0314T8	ASD0323T8 ASD0323KT8 ASLD0323T8	ASD0335T8 ASD0335KT8 ASD0335T8
		3	0	X	X	HW-U01-F	Illuminated Knob				
		4	X	X	0	HW-U01-F					
	314	1	0	X	0	HW-U01-F					
		2	X	X	0	HW-U01-F	Knob/Lever Key	ASD0306T8 ASD0306KT8 ASLD0306T8	ASD0310T8 ASD0301KT8 ASLD0301T8	ASD0328T8 ASD0328KT8 ASLD0328T8	ASLD0339T8 ASD0339KT8 ASLD0339T8
		3	0	X	0	HW-U01-F	Illuminated Knob				
		4	X	X	0	HW-U01-F					

- Each operator sub-assembly is available as an "02" and an "06" for 3-position selector switches. The internal cam of an "02" is different from that of an "06". This results in designated combinations of open and closed contacts in the various operator positions.
- N/D = No circuit number designation required in assembled part number.
- X = On (closed contacts) 0 = Off (open contacts). X-X Overlapping contacts remain on (closed) when switch is moved between these two positions.

Operator Truth Tables

Use the following tables to build custom selector switches.

2 Position Selector Switches

	Contact	Mounting Position	Operator Position	
			Left	Right
ASLD0201T8	HW-U10-F (NO)	L	0	X
		R	0	X
	HW-U01-F (NC)	L	X	0
		R	X	0
	HW-U10R-F (NO-EM)	L	0	X-X
		R	0	X-X
	HW-U01R-F (NC-LB)	L	X-X	0
		R	X-X	0

3 Position Selector Switches

	Contact	Mounting Position	Operator Position		
			Left	Center	Right
ASD0302T8 ASLD0302T8 ASD0302KT8	HW-U10-F (NO)	L	X	0	0
		R	0	0	X
	HW-U01-F (NC)	L	0	X-X	0
		R	X-X	0	0
	HW-U10R-F (NO-EM)	L	X	0	0
		R	0	0	X
	HW-U10R-F (NC-LB)	L	0	X-X	0
		R	X-X	X	0

	Contact	Mounting Position	Operator Position		
			Left	Center	Right
ASD0306T8 ASLD0306T8 ASD0306KT8	HW-U10-F (NO)	L	X	0	X
		R	0	0	X
	HW-U01-F (NC)	L	0	X	0
		R	X-X	0	0
	HW-U10R-F (NO-EM)	L	X	0	X
		R	0	0	X
	HW-U01R-F (NC-LB)	L	0	X	0
		R	X-X	X	0



Accessories — TWND Series

Item	Appearance	Description/Usage	Part Number
Lamp Removal Tool		Rubber tool used to install or remove LED's	OR-55
Metal Bezel		Standard octagonal units (chrome-pl.).	OG-81
		Extended, non-illuminated (chrome-pl.).	OG-82
		Extended, illuminated (chrome-pl.).	OG-83L
		Jumbo Mushroom Shallow Shroud	ABN4G
		Jumbo Mushroom Deep Shroud	ABN4F
Plastic Bezel		Black plastic locking ring/bezel	OGP11B
Boot/Cover		In place of ⊕, specify Neoprene Rubber Boot color: B (black), G (green), R (red), Y (yellow)	OC-11 ⊕
		Flush units (clear plastic -40° to +60°C).	OC-121
		Extended units (clear plastic -40° to +60°C).	OC-122
Anti-Rotation Ring		Plastic washer For nameplates or panels that should not be scratched.	OGL-D1T
		Thrust washer/Anti-rotation ring for use with notched panel cutout.	OGL-D1S
Mounting Hole Plug		Plastic with locking nut attached.	OBP-11
		Metal with locking nut attached	OB-11
		Grey rubber (-5° to +60°C)	OB-13
Terminal Tab Adaptor		Tab #250 17/64" x 3/64" (6.35mm x 0.8mm); Single tab	TW-FA4
Long Lamp Holder		Used with Transformer and two contact blocks Used with Full Voltage Adaptor and two contact blocks	TW-LH2
Lead Holder		Used with TW-LH2 holder when using four contact blocks	HW-LH3
Lock Out Adaptor		Used to provide lockout protection for TWTD pushbuttons and knob selectors. ø 1-13/64" (30mm)	OL-KL1
Full Voltage Clips		Primary Voltage (50/60Hz) Required for all full voltage pilot lights. Two pieces each. 2 clips required for full voltage pilot lights.	APD-F
Replacement Keys		Pair of keys (#0)	TW-SK

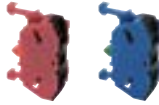
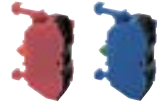
Accessories TWND Series continued

Item	Appearance	Description/Usage	Part Number	
			1NC	1NO
Contact Blocks (with side entry)		These contacts are applicable for wires terminated by ring, fork, terminals, not recommended for bare wire connections.	HW-U01 HW-U01-MAU HW-U01R HW-U01R-MAU (with side entry)	HW-U10 HW-U10-MAU HW-U10R HW-U10R-MAU (with side entry)
Contact Blocks (without side entry)		These contacts are applicable for wires terminated by ring, fork, or ferule terminals, and also bare wire connections.	HW-U01-F HW-U01-MAU-F HW-U01R-F HW-U01R-MAU-F (no side entry)	HW-U10-F HW-U10-MAU-F HW-U10R-F HW-U10R-MAU-F (no side entry)

Fingersafe Covers for TWND Series

Item	Description	Used with	Part Number
	Fingersafe terminal cover, for full voltage pilot lights, adds 3mm to overall depth	Full voltage pilot lights	APD-PVL
	Fingersafe terminal cover, adds 1.5mm to overall depth	Transformer pilot lights	N-VL3

Nameplates – TWND Series

Faceplates

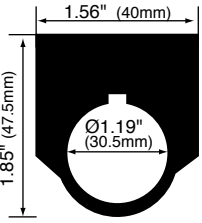
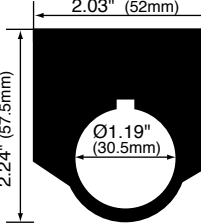
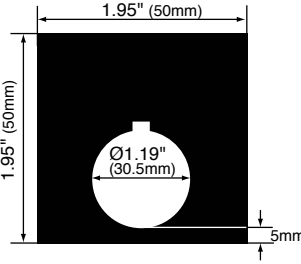
	NALD	NAKD	NAQD
Dimensions			
Description	Part Number		
Nameplate (blank)	NALD-B (black) NALD-R (red)	NAKD-B (black) NAKD-R (red)	NAQD-B (black) NAQD-R (red)
Nameplate (engraved)	NALD-⓪	NAKD-⓪	NAQD-⓪

1. Nameplates are made of 0.031" aluminum. Lettering is white letters engraved on black background.
2. In place of ⓪, insert either the standard legend code from table below or custom engraving delimited by " ".

Standard Legend Codes

Pushbuttons				Pushbuttons/Selector Switches				Selector Switches	
Legend	Code	Legend	Code	Legend	Code	Legend	Code	Legend	Code
AUTO	101	OPEN	116	AUTO-MAN	201			AUTO-MAN-OFF	301
CLOSE	102	OUT	117	CLOSE-OPEN	202			AUTO-OFF-MAN	302
DOWN	103	RAISE	118	DOWN-UP	203			CLOSE-OFF-OPEN	303
EMERG.STOP*	104	RESET	119	FAST-SLOW	204			DOWN-OFF-SLOW	304
FAST	105	REVERSE	120	FOR-REV	205	REV-FOR	216	FAST-OFF-SLOW	305
FORWARD	106	RUN	121	HAND-AUTO	206	RUN-JOG	217	FOR-OFF-REV	306
HAND	107	SLOW	122	HIGH-LOW	207	RUN-SAFE	218	LEFT-OFF-RIGHT	307
HIGH	108	START	123	JOG-RUN	208	SAFE-RUN	219	LOWER-OFF-RAISE	308
IN	109	STOP*	124	LEFT-RIGHT	209	SLOW-FAST	220	OFF-MAN-AUTO	309
INCH	110	STOP	125	LOWER-RAISE	210	START-STOP	221	OFF-SLOW-FAST	310
JOG	111	TEST	126	MAN-AUTO	211	STOP-START	222	OFF-1-2	311
LOW	112	UP	127	OFF-ON	212	UP-DOWN	223	OPEN-OFF-CLOSE	312
LOWER	113	I (Int'l On)	150	ON-OFF	213			SLOW-OFF-FAST	313
OFF	114	O (Int'l Off)	151	OPEN-CLOSE	214			SUMMER-OFF-WINTER	314
ON	115	EMO	152	RAISE-LOWER	215			UP-OFF-DOWN	315
								1-OFF-2	316
								HAND-OFF-AUTO	317

1. *Available in Red as standard legend code 104 and 124. To order engraved nameplate and codes, add legend code to nameplate part number. Character height based on the number of characters, space and size of nameplate. Standard character size is 3/16".
2. Nameplates with standard legends are the same list price as blank nameplates. Special engravings, additional cost.

To specify engraving instructions, use the Nameplate order form on next page.

Custom engraved Nameplates Order Form – TWND Series

Copy this order form and use it to specify Letter Height, Custom Engravings, Location of Engraving on Nameplate, and Quantity Desired.

To ensure engraving accuracy, fax it to your IDEC representative. or Distributor.

Your Company Name: _____

IDEC Rep/Distributor Contact: _____

Your Name: _____

PO number (if known): _____

Telephone: _____

IDEC Rep/Distributor Phone: _____

Fax & Email: _____

IDEC Rep/Distributor Fax & Email: _____

NALD Nameplate

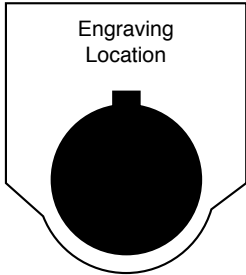

Step 1.

Choose Letter Size - 7/64" or 1/8".

Check the box for the letter size you want. Then write your lettering in box below checkboxes. Note: 1/8" size letters cannot exceed 13 characters.

Sample Letter Sizes

7/64"
Letter Size 16 characters max
(for 7/64" size letters)

7/64" Letters: **A B C D**

1/8" Letters: **A B C D**

1/8"
Letter Size 13 characters max
(for 1/8" size letters)

Step 2.

Specify Quantity.

Enter the number of nameplates desired in the box on the right.

Qty

1	2	3	4	5	6	7	8	9	10	11	12	13	14	15	16
---	---	---	---	---	---	---	---	---	----	----	----	----	----	----	----

NAKD Nameplate

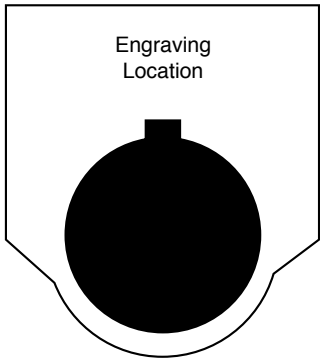

Step 1.

Choose Letter Size - 7/64" or 1/8".

Check the box for the letter size you want. Then write your lettering in box below checkboxes. Note: 1/8" size letters cannot exceed 9 characters.

Step 2.

Specify Quantity.

Enter the number of nameplates desired in the box on the right.

Qty

1	2	3	4	5	6	7	8	9	10	11	12	13	14	15	16	17
---	---	---	---	---	---	---	---	---	----	----	----	----	----	----	----	----

Sample Letter Sizes

1/8" Letters: **A B C D**

NAQD Nameplate

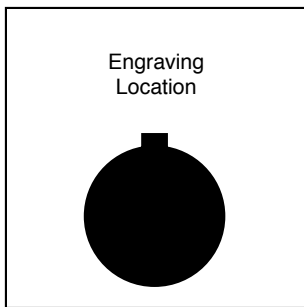

Step 1.

Choose Letter Size - 7/64" or 1/8".

Check the box for the letter size you want. Then write your lettering in box below checkboxes.

Note: 1/8" size letters cannot exceed 16 characters.

7/64"
Letter Size 20 characters max
(for 7/64" size letters)

1/8"
Letter Size 16 characters max
(for 1/8" size letters)

Step 2.

Specify Quantity.

Enter the number of nameplates desired in the box on the right.

Qty

1	2	3	4	5	6	7	8	9	10	11	12	13	14	15	16	17	18	19	20
---	---	---	---	---	---	---	---	---	----	----	----	----	----	----	----	----	----	----	----

Sample Letter Sizes

3/32" Letters: **A B C D**

1/8" Letters: **A B C D**

Switches & Pilot Devices

Signaling Lights

Relays & Sockets

Timers

Contactors

Terminal Blocks

Circuit Breakers

Switch Engraving Order Form – TWND Series

Copy this order form and use it to specify Letter Height, Maximum Number of Lines and Text to be engraved.

To insure engraving accuracy, fax it to your IDEC representative or Distributor.

Your Company: _____
 Name: _____
 Address: _____
 PO: _____

Telephone: _____
 Fax: _____
 Email: _____
 Part Number to be Engraved: _____

Please check one of the boxes below to indicate your choice of engraving options:



ø29mm, ø40mm Mushroom Head



	# of Lines	Letter Height	Max. Characters Per Line
<input type="checkbox"/>	1	5/32	7
<input type="checkbox"/>		1/8	8
<input type="checkbox"/>	2	5/32	7
<input type="checkbox"/>		1/8	8
<input type="checkbox"/>	3	1/8	8
<input type="checkbox"/>	4	Custom*	

	# of Lines	Letter Height	Max. Characters Per Line
<input type="checkbox"/>	1	3/4	4
<input type="checkbox"/>		5/16	5
<input type="checkbox"/>	2	5/16	5
<input type="checkbox"/>		1/4	6
<input type="checkbox"/>		5/32	8
<input type="checkbox"/>	3	5/32	8
<input type="checkbox"/>		1/8	9
<input type="checkbox"/>	4	1/8	9

	# of Lines	Letter Height	Max. Characters Per Line
<input type="checkbox"/>	Engraving Area 1	5/32	5
<input type="checkbox"/>		1/8	5
<input type="checkbox"/>	Engraving Area 2	5/32	7
<input type="checkbox"/>		1/8	7

*Engraving is possible, but character size will be smaller than standard sizes.



	# of Lines	Letter Height	Max. Characters Per Line
<input type="checkbox"/>	1	5/32	7
<input type="checkbox"/>		1/8	8
<input type="checkbox"/>	2	5/32	7
<input type="checkbox"/>		1/8	8
<input type="checkbox"/>	3	1/8	8
<input type="checkbox"/>	4	Custom*	

*Engraving is possible, but character size will be smaller than standard sizes.



- Above mentioned specifications hold true for standard size push-buttons (round and square).
- *Engraving Area 2 can be engraved for 40mm mushroom head non-illuminated pushbutton only.
- Engraving is done on the button itself for non-illuminated push buttons and on marking plate for illuminated push buttons and pilot lights.
- Please enter text exactly how you want it engraved, take care to emphasize capital or small letters.

Enter text to be engraved:

Line 1: _____
 Line 2: _____
 Line 3: _____
 Line 4: _____

Sample Letter Sizes

1/8 Letters: **OPEN**

5/32 Letters: **OPEN**



All engraving is 5/8mm wide.

For IDEC Internal Use Only:

Work Order #: _____

Dimensions (mm)

Pushbutton

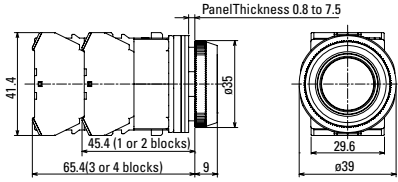

Pushbuttons	Dimension A	Dimension B
Flush	0.351" (9mm)	ø 0.975" (25mm)
Extended	0.566" (14.5mm)	ø 0.975" (25mm)
Extended w/Full Shroud	0.663" (17mm)	ø 1.11" (28.5mm)
Mushroom	0.858" (22mm)	ø 1.56" (40mm)
Mushroom w/Full Shroud	0.936" (24mm)	ø 1.87" (48mm)
Jumbo Mushroom	1.13" (29mm)	ø 2.54" (65mm)
Mushroom, Pushlock Turn Reset and Push-Pull	*0.975" (25mm) **0.975" (25mm)	ø 1.56" (40mm) ø 1.56" (40mm)

Mushroom Pushbutton w/Full Shroud

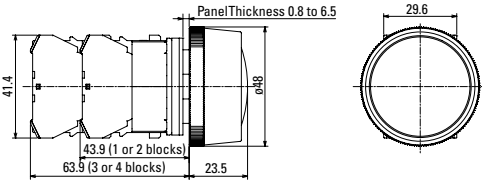

*Dimension when operator is in reset position.
**Dimension when operator is in pull position.

Illuminated Pushbuttons

w/Transformer

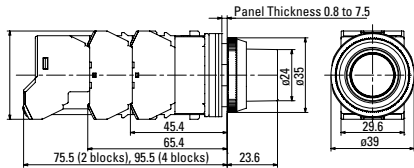

Full Voltage

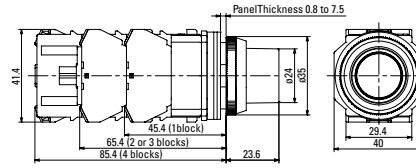

Illuminated Pushbuttons	Dimension A	Dimension B
Flush w/Full Shroud	0.975" (25mm) 0.995" (25.5mm)	ø 0.936" (24mm) ø 0.936" (24mm)
Extended w/Full Shroud	0.741" (19mm) 0.761" (19.5mm)	ø 0.936" (24mm) ø 0.936" (24mm)
ø 1.56" (40mm) Mushroom Pushlock Turn Reset, Push-Pull	*0.975" (25mm) **0.975" (25mm)	ø 1.56" (40mm) ø 1.56" (40mm)



*Dimension when operator is in reset position.
**Dimension when operator is in pull position.

Pilot Lights

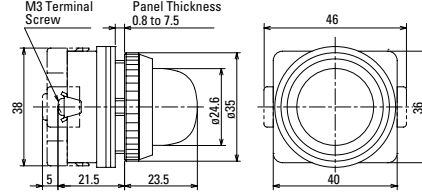

Selector Switches

Knob

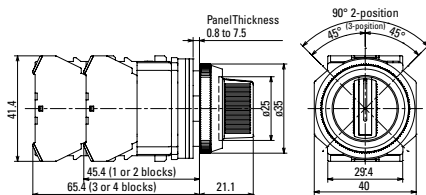

Lever

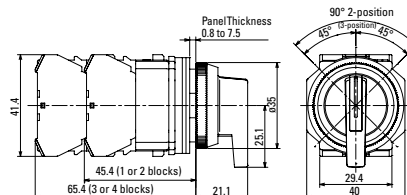

Key

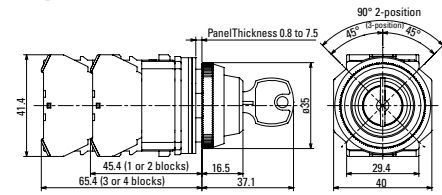

Illuminated Knob

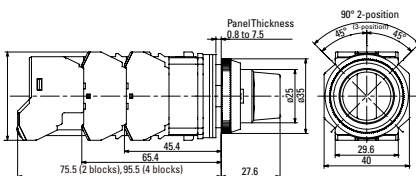

Selector Switches Panel Cut-Out

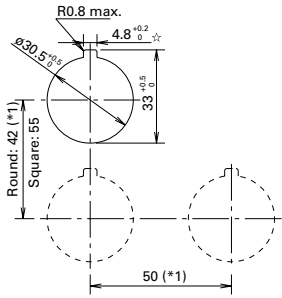

1. *Jumbo Mushroom < 2.61" (66mm)
2. Minimum mounting centers are applicable to switches with one stack of contact blocks. When mounting two stacks of contact blocks, minimum centers should allow for access to wiring.
3. The ø 0.195" (ø 5mm) recess is necessary when either the nameplate or anti-rotation ring is used.

Illuminated Selector Switches

OL-KL1
Lock-Out Adaptor

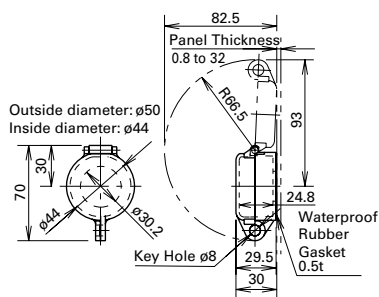

OC-31
Pushbutton Clear Boot

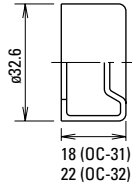

OGL-31
Anti-Rotation Ring

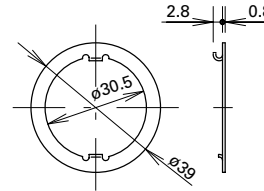

OB-31
Mounting Hole Rubber Plug

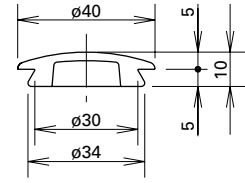

Finger-Safe Cover

N-VL3

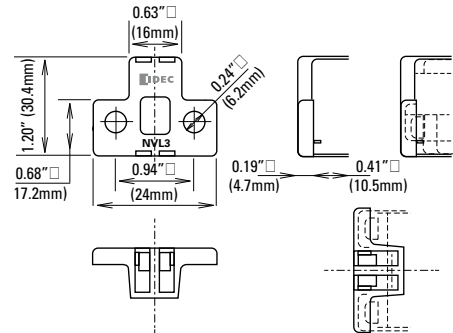

APD-PVL

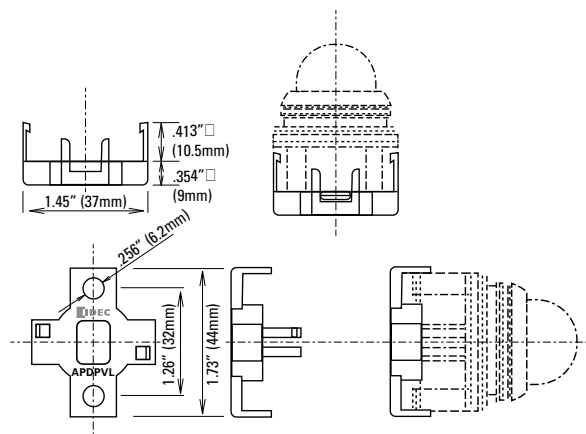

Operating Instructions

Adjustment for Panel Thickness

Each unit is shipped with several waterproof gaskets which are 0.06" (1.5mm) and 0.12" (3mm) thick. Combine the gaskets for a dimension approximately equal to panel thickness and install between the bezel and the body of the unit.

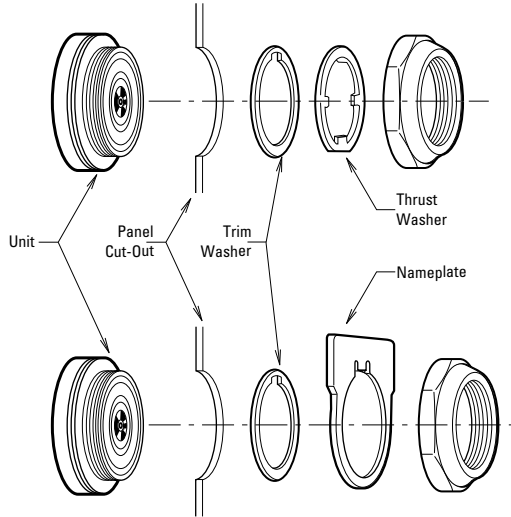

A trim washer must be used with a thrust washer or a nameplate to prevent the control unit from rotating in the mounting hole. When using anti-rotation rings (trim washer with thrust washer or nameplate), install as shown below.

Selector Switches

The operator shaft of each unit has a recess to identify in which direction to install the handle. Align the handle with the recess. Press color insert (TW-HC1) into the Standard Operating Positions.

Standard Operation Positions



Non-Illuminated 3-Position Operators

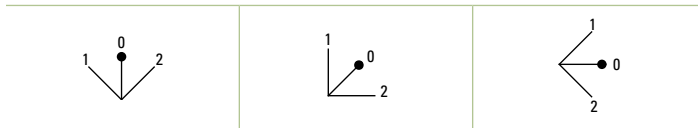

Installation of LED Illuminated Units

Transformer units are recommended for use in areas subjected to inductive noise.

Application Example For Push-To-Test Pilot Light

A typical application of illuminated pushbuttons is a push-to-test pilot light which can be used to check the lamp/LED circuit.

Transformer/AC-Adapter Circuit

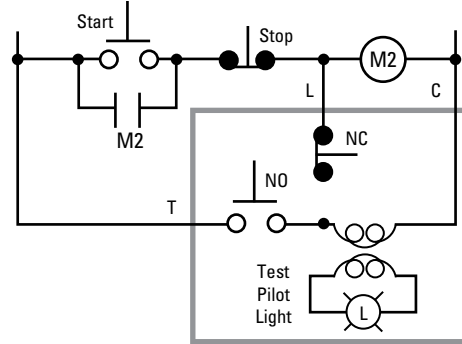

Full Voltage Circuit

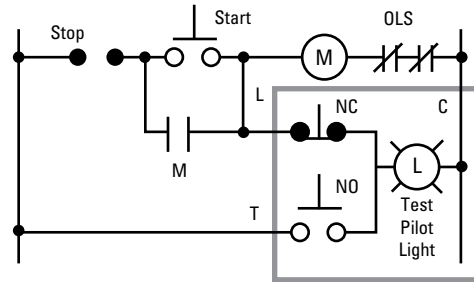

TWTD Series — Full Size NEMA Pushbuttons

**TWTD Series: Heavy duty switches built to last****Key features:**

- Variety of button sizes up to 2 9/16" (65mm)
- Rugged construction includes chrome plated zinc locking ring die cast zinc mounting threads, screw mounted contact blocks
- LED or incandescent illumination
- Transformer or full voltage
- Transparent contact windows
- Slow make, double break self-clearing contacts
- Modular construction for maximum flexibility
- Double nickel plated terminal screws
- Available assembled or as sub-components
- Type 4x and IP65 watertight/oiltight panel
- Large M3.5 screw terminals with captive sems plate

The rugged series of TWTD switches offers both variety and durability in an attractive design.

With button sizes up to 2 9/16" (65mm), chrome plated zinc locking rings, die cast zinc mounting threads, steel anti-rotation rings, and self cleaning contacts, the TWTDs are here to stay.

The TWTD series also offers either LED or incandescent illumination in full voltage and transformer models.

Transparent contact windows allow the viewing of IDEC's self cleaning slow-make/slow-break contacts.

Regardless of your switching needs, the TWTD series provides the kind of long lasting, industrial strength quality you've come to expect from IDEC.



UL Listed
File No. E68961



File No. LR21451



Ref No. 117617MC



Certificate No.
2005010305145658

Switches & Pilot Devices

Specifications

Conforming to Standards	EN60947-1, EN60947-5-1, VDE0660-200, UL508, CSA C22-2 No.14
Approvals	CSA: pushbuttons and selector switches: A600 pilot lights and illuminated pushbuttons, direct supply pilot lights and illuminated pushbuttons with integral transformer (100/110, 115, 120, 200/220, 230, 240, 380, 400/440, 480V) UL: pushbuttons and selector switches: A600 pilot lights and illuminated pushbuttons, direct supply pilot lights and illuminated pushbuttons with integral transformer (100/110, 115, 120, 200/220, 230, 240, 380, 400/440, 480V) TÜV: pushbuttons and selector switches: A600=P600 (NO, NC)/Q600 (NO-EM, NC-LB) pilot lights and illuminated pushbuttons, direct supply pilot lights and illuminated pushbuttons with integral transformer (100/110, 115, 120, 200/220, 230, 240, 380, 400/440, 480V)
Operating Temperature	Operation: -25 to +50°C (without freezing) Storage: -40 to +70°C (without freezing)
Vibration Resistance	10 to 55Hz, 98m/sec ² (10g) conforming to IEC6068-2-6
Shock Resistance	980m/sec ² (100g) conforming to IEC6068-2-7
Electric Shock Protection	Class 0 conforming to IEC60536
Degree of Protection	IP65 (from front of the panel) (conforming to IEC60529) IP54 (key switches) Type 1, 2, 3, 3R, 3S, 4, 4X, 5, 12, 13 (conforming to NEMA ICS6-110)
Mechanical Life	Momentary pushbuttons: 5,000,000 (900 operations per hour) All other switches: 500,000
Pollution Degree (conforming to IEC60947-1)	3 for switches not using a transformer 2 for switches using a transformer

Signaling Lights

Relays & Sockets

Mechanical-Electrical Specifications

Rated Operational Characteristics	AC-15: A600 or Ue = 250V, Ie = 3A (NO, NC, NO-EM, NC-LB) DC-13: P600 or Ue = 125V, Ie = 1.1A (NO, NC) DC-13: Q600 or Ue = 125V, Ie = 0.9A (NO-EM, NC-LB)
Rated Insulation Voltage	600V
Rated Switching Overvoltage	Less than 4kV, conforming to IEC60947-1
Rated Impulse Withstanding Voltage	4kV for contact circuit 2.5kV for lamp circuit
Rated Thermal Current	10 Amp
Minimum Switching Capacity	5 mA at 3V AC/DC
Contact Operation	Slow break NC or NO, self-cleaning
Operating Force	Flush and extended pushbuttons—with 1NO or 1NC contact: 6.2±2N (momentary), 7.0±2N (maintained) Additional contacts—1NO or 1NC: +3.2N (momentary), + 3.3N (maintained)
Terminal Referencing	Conforming to CENELEC EN50005
Recommended Terminal Torque	0.8 N m (7.1 in lb.)
External Short-Circuit Protection	10A 250V fuse conforming to IEC60269-1
Applicable Wire Size	Minimum 1 x 22 AWG, max. 2 x 14 AWG or 1 x 12 AWG
Contact Resistance	Initial contact resistance of 50mΩ or less
Contact Gap	4mm (NO and NC) 2mm (NO-EM and NC-LB)
Lamp Ratings	Incandescent: 1 W LEDs: 6V: 17mA, 12V: 11mA, 24V: 11mA, / 120, 240V: 10mA
Maximum Inrush Current	40 A (40 msec)
Contact Material	Silver

Timers

Contactors

Terminal Blocks

Contact Ratings

Contact Ratings by Utilization Category IEC 60947-5-1		AC-15 (A600)						
		DC-13 (P600)						
Contact Ratings by Utilization Category								
Operational Voltage			24V	48V	50V	110V	220V	440V
Operation Current	AC 50/60 Hz	AC-12 Control of resistive loads & solid state loads	10A	—	10A	10A	6A	2A
		AC-15 Control of electromagnetic loads (> 72VA)	10A	—	7A	5A	3A	1A
	DC	DC-12 Control of resistive loads & solid state loads	8A	5A	—	2.2A	1.1A	—
		DC-13 Control of electromagnets	5A	2A	—	1.1A	0.6A	—

Circuit Breakers

Non-Illuminated Pushbuttons (Assembled)



Assembled Pushbuttons

A **B** **()** **D** **1** **10** **N - R**

<p>Function</p> <p>B: Momentary O: Maintained V: Pushlock Turn Reset Y: Push-Pull</p> <p>Bezel Shape</p> <p>Blank: Octagonal F: Full Shroud G: Mushroom Shroud P: Neoprene Boot</p> <p>Series Designation</p> <p>D: TWTD Series</p>	<p>Button Color</p> <p>B: Black G: Green W: White R: Red S: Blue Y: Yellow</p> <p>Contact Arrangement</p> <p>10: 1NO 01: 1NC 20: 2NO 02: 2NC 11: 1NO-1NC 22: 2NO-2NC</p> <p>Button Shape</p> <p>1: Flush 2: Extended 3: Mushroom ø 40mm 4: Jumbo Mushroom ø 65mm</p>
--	--

- 1. Use only when interpreting part numbers. Do not use for developing part numbers.
- 2. Custom contact configurations available, contact IDEC for details.

Non-Illuminated Pushbuttons (Assembled)

Non-Illuminated Pushbuttons

Style	Contacts	Momentary	Maintained
Flush	1NO	ABD110N-⓪	AOD110N-⓪
	1NC	ABD101N-⓪	AOD101N-⓪
	1NO-1NC	ABD111N-⓪	AOD111N-⓪
	2NO	ABD120N-⓪	AOD120N-⓪
	2NC	ABD102N-⓪	AOD102N-⓪
Extended	1NO	ABD210N-⓪	AOD210N-⓪
	1NC	ABD201N-⓪	AOD201N-⓪
	1NO-1NC	ABD211N-⓪	AOD211N-⓪
	2NO	ABD220N-⓪	AOD220N-⓪
	2NC	ABD202N-⓪	AOD202N-⓪
Extended with Neoprene Boot ¹	1NO	ABPD210N-⓪	AOPD210N-⓪
	1NC	ABPD201N-⓪	AOPD201N-⓪
	1NO-1NC	ABPD211N-⓪	AOPD211N-⓪
	2NO	ABPD220N-⓪	AOPD220N-⓪
	2NC	ABPD202N-⓪	AOPD202N-⓪
Recessed	1NO	ABFD110N-⓪	AOFD110N-⓪
	1NC	ABFD101N-⓪	AOFD101N-⓪
	1NO-1NC	ABFD111N-⓪	AOFD111N-⓪
	2NO	ABFD120N-⓪	AOFD120N-⓪
	2NC	ABFD102N-⓪	AOFD102N-⓪
Extended with Full Shroud	1NO	ABFD210N-⓪	AOFD210N-⓪
	1NC	ABFD201N-⓪	AOFD201N-⓪
	1NO-1NC	ABFD211N-⓪	AOFD211N-⓪
	2NO	ABFD220N-⓪	AOFD220N-⓪
	2NC	ABFD202N-⓪	AOFD202N-⓪
ø 40mm Mushroom Head	1NO	ABD310N-⓪	AOD310N-⓪
	1NC	ABD301N-⓪	AOD301N-⓪
	1NO-1NC	ABD311N-⓪	AOD311N-⓪
	2NO	ABD320N-⓪	AOD320N-⓪
	2NC	ABD302N-⓪	AOD302N-⓪
ø 40mm Mushroom Head with Full Shroud	1NO	ABGD310N-⓪	AOGD310N-⓪
	1NC	ABGD301N-⓪	AOGD301N-⓪
	1NO-1NC	ABGD311N-⓪	AOGD311N-⓪
	2NO	ABGD320N-⓪	AOGD320N-⓪
	2NC	ABGD302N-⓪	AOGD302N-⓪
ø 65mm Jumbo Mushroom Head	1NO	ABD410N-⓪	AOD410N-⓪
	1NC	ABD401N-⓪	AOD401N-⓪
	1NO-1NC	ABD411N-⓪	AOD411N-⓪
	2NO	ABD420N-⓪	AOD420N-⓪
	2NC	ABD402N-⓪	AOD402N-⓪
ø 65mm Jumbo Mushroom Head with Shallow Shroud	1NO	ABGD410N-⓪	AOGD410N-⓪
	1NC	ABGD401N-⓪	AOGD401N-⓪
	1NO-1NC	ABGD411N-⓪	AOGD411N-⓪
	2NO	ABGD420N-⓪	AOGD420N-⓪
	2NC	ABGD402N-⓪	AOGD402N-⓪
ø 65mm Jumbo Mushroom Head With Deep Shroud	1NO	ABFD410N-⓪	AOFD410N-⓪
	1NC	ABFD401N-⓪	AOFD401N-⓪
	1NO-1NC	ABFD411N-⓪	AOFD411N-⓪
	2NO	ABFD420N-⓪	AOFD420N-⓪
	2NC	ABFD402N-⓪	AOFD402N-⓪

⓪ Button Color Codes

Color	Code
Black	B
Green	G
Red	R
Blue	S
Yellow	Y
White	W

- 1. 65mm Jumbo mushroom not available in white.
- 2. Neoprene boot is not available in blue or white.

- 1. In place of ⓪, specify the Button Color Code.
- 2. For sub-assembly part numbers, see next page.
- 4. ¹Neoprene boot available only in Black (B), Green (G), Red (R) and Yellow (Y).

Non-Illuminated Pushbuttons (Sub-Assembled)

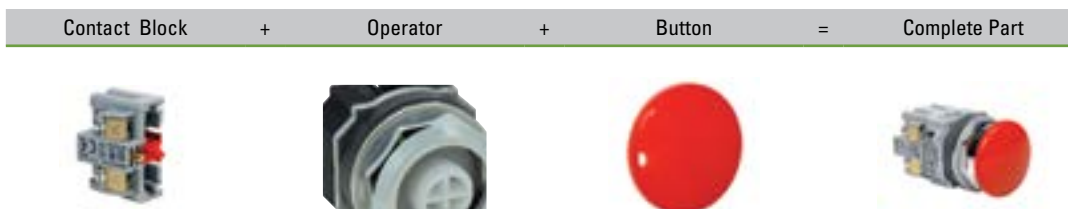

Operators

Style	Image	Part Number	
		Momentary	Maintained
Flush/Extended		ABD-100	AOD-100
Extended with Full Shroud		ABFD-200	AOFD-200
ø 40mm Mushroom/ø 65mm Jumbo Mushroom		ABD-300	AOD-300
ø 40mm Mushroom with Full Shroud		ABGD-300	AOGD-300
ø 65mm Jumbo Mushroom with Shallow Shroud		ABGD-400	AOGD-400
ø 65mm Jumbo Mushroom with Deep Shroud		ABFD-400	AOFD-400

Buttons and Lenses

Style	Image	Part Number
Flush		ABD1BN-Ⓢ
Extended		ABD2BN-Ⓢ
ø 40mm Mushroom		ABD3BN-Ⓢ
ø 65mm Jumbo Mushroom		ABD4BN-Ⓢ

In place of Ⓢ, specify the Button Color Code. (See table previous page)

Contact Blocks

Style	Image	Part Number	
		1NO	1NC
All Control Units		BST-010 BST-010S (early make)	BST-001 BST-001S (late break)
Dummy Block		BST-D	

- 1. Dummy blocks (no contacts) are used with an odd number of contact blocks.
- 2. Combining BST-010S and BST-001S result in overlapping contacts (remain on, or closed, when switch is moved between two positions).

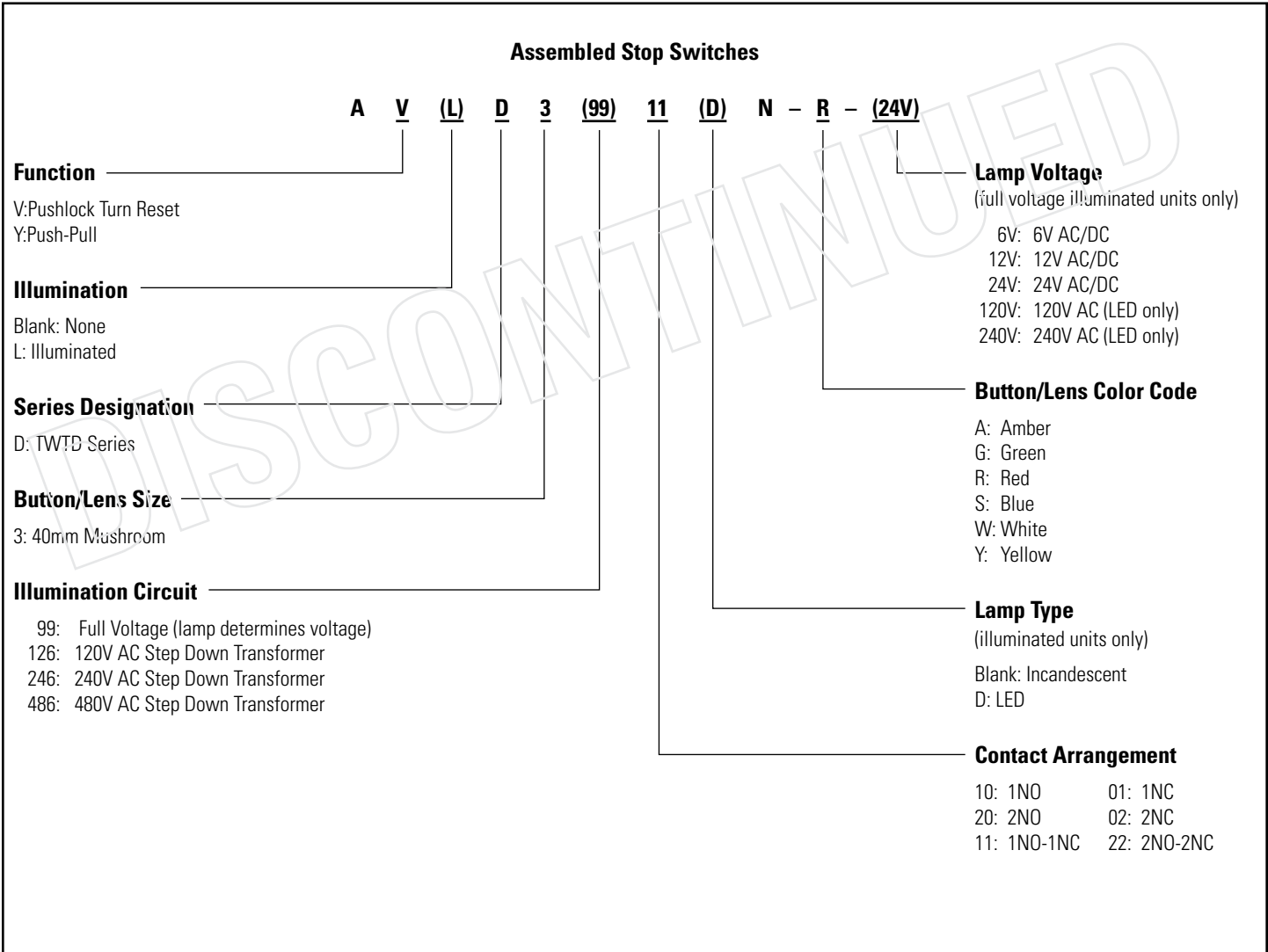

Stop Switches (Assembled)



1. Use only when interpreting part numbers. Do not use for developing part numbers.
2. Custom contact configurations available, contact IDEC for details.

Stop Switches (Assembled)

Stop Switches

Style	Contacts	Part Number
ø 40mm Pushlock Turn Reset 	1NO 1NC 1NO-1NC 2NO 2NC	AVD310N-R* AVD301N-R* AVD311N-R* AVD320N-R* AVD302N-R*
ø 40mm Illuminated Pushlock Turn Reset 	1NO-1NC 2NO 2NC	AVLD39911ⓈN-R-Ⓢ* AVLD39920ⓈN-R-Ⓢ* AVLD39902ⓈN-R-Ⓢ*
	1NO-1NC 2NO 2NC	AVLD3 Ⓢ 11ⓈN-R* AVLD3 Ⓢ 20ⓈN-R* AVLD3 Ⓢ 02ⓈN-R*
ø 40mm Push-Pull 	1NO 1NC 1NO-1NC 2NO 2NC	AYD310N-Ⓢ AYD301N-Ⓢ AYD311N-Ⓢ AYD320N-Ⓢ AYD302N-Ⓢ
ø 40mm Push-Pull 	1NO-1NC 2NO 2NC	AYLD39911ⓈN-Ⓢ-Ⓢ** AYLD39920ⓈN-Ⓢ-Ⓢ** AYLD39902ⓈN-Ⓢ-Ⓢ**
	1NO-1NC 2NO 2NC	AYLD3 Ⓢ 11ⓈN-Ⓢ** AYLD3 Ⓢ 20ⓈN-Ⓢ** AYLD3 Ⓢ 02ⓈN-Ⓢ**
ø 40mm Momentary Push-Pull (3-position) 	1NO-1NC 1NC-1LB†	AYLD229911ⓈN-Ⓢ-Ⓢ -TK962 AYLD229902SⓈN-Ⓢ-Ⓢ-TK962
	1NO-1NC 1NC-1LB†	AYLD22 Ⓢ 11ⓈN-Ⓢ-TK962 AYLD22 Ⓢ 02SⓈN-Ⓢ-TK962

Unibody E-Stops

Style	Contacts	Part Number
ø 40mm Pushlock Turn Reset (available in Red only) 	1NO-1NC 2NC	HN1E-BV4F11-R* HN1E-BV4F02-R*
Illuminated ø 40mm Pushlock Turn Reset (available in Red only) 	1NO-1NC 2NC	HN1E-LV4F11QⓈ-R-Ⓢ HN1E-LV4F02QⓈ-R-Ⓢ

- In place of Ⓢ, specify the button color code
- In place of Ⓢ, specify the lens color code.
- In place of Ⓢ, specify the Full Voltage (lamp voltage) Code.
- In place of Ⓢ, specify the transformer voltage code.
- In place of Ⓢ, specify the Lamp Type code.
- With single unit construction, the positive action contacts are integrated in the body of the switch. This provides an extra degree of safety and reliability for critical emergency stop functions.
- HN1E series E-stops comply with the IEC "E-Stop Addendum to the Low Voltage Directive," this includes "tamper proof" operation whereby a change of contact state is not possible by "teasing" or "floating" the operator.
- 3 position push-pull available in spring return to center only.
- *Available in red only.
- **Not available in blue.
- †The most common configuration for motor starting applications.
- For sub-assembly part numbers, see next page.
- For nameplates and accessories, see page 797 and page 795.
- For dimensions, see page 800.

3 Position Push-Pull†

Contact	Push	Center	Pull
NC (BST-001)	0	0	X
NC-LB (BST-001S)	0	X	X
NO (BST-010)	X	0	0
NO-EM (BST-010S)	X	X	0

① Button Color Codes

Color	Code
Black	B
Green	G
Red	R
Blue	S
Yellow	Y

Ⓢ LED/Lens Color Codes

Color	Code
Amber	A
Green	G
Red	R
Blue	S
White	W

③ Full Voltage Codes

Voltage	Code
6V AC/DC	6V
12V AC/DC	12V
24V AC/DC	24V
120V AC	120V
240V AC	240V (LED only)

Ⓢ Transformer Voltage Codes

Voltage	Code
120VAC	126
240VAC	246
480VAC	486

 Transformers step down to 6V.

Ⓢ Lamp Type Codes

Lamp	Code
Incandescent	Blank
LED	D

Stop Switches (Sub-Assembled)







* Not required for full voltage units (full voltage clips used instead).

Operators



Style	Part Number
 ø40mm Pushlock Turn Reset	AVD-300
 Illuminated ø40mm Pushlock Turn Reset	AVLD3-0600N
 ø40mm Push-Pull	AYD-3100
 Illuminated ø 40mm Push-Pull	2 pos AYLD-0600 3 pos AYLD22TK9C2-0B01

Buttons and Lenses

Style	Part Number
 Button for Pushlock Turn Reset Stop Switches (ø40mm, red only)	AVN3B-R
 Lens for Illuminated Pushlock Turn Reset Stop Switches (ø40mm, red only)	AVLN3LU-R
 Button for Push-Pull Stop Switches (ø40mm)	AYD3BN-①
 Lens for Illuminated Push-Pull Stop Switches (ø40mm)	2 pos* AYLD3L-② 3 pos AYLD2L-②

- 1. In place of ①, specify the Button Color Code. (See table below)
- 2. In place of ②, specify the LED Color Code.
- 3. *Not available in blue.

Lamps

Style	Voltage	Part Number
 LED	6V AC/DC	LSTD-6②
	12V AC/DC	LSTD-1②
	24V AC/DC	LSTD-2②
	120V AC	LSTD-H2②
	240V AC	LSTD-M4②
 Incandescent	6V AC/DC	IS-6
	12V AC/DC	IS-12
	24V AC/DC	IS-24
	120V AC	L-120L

- 1. In place of ②, specify the LED color code.
- 2. The LED contains a current-limiting resistor and a protection diode.

① Button Color Codes

Color	Code
Black	B
Green	G
Red	R
Blue	S
Yellow	Y

② LED Color Codes

Color	Code
Amber	A
Green	G
Red	R
Blue	S
White	W

Contact Blocks

Style	Part Number	
	1NO	1NC
 All Control Units	BST-010	BST-001
	BST-010S (early make)	BST-001S (late break)
Dummy Block	BST-D	

- 1. Dummy blocks (no contacts) are used with an odd number of contact blocks.
- 2. Combining BST-010S and BST-001S result in overlapping contacts.

Full Voltage Clips

Primary Voltage (50/60Hz)	Part Number
 Full Voltage Clips (2 required for each unit)	APD-F

Transformers

Style	Primary Voltage (50/60Hz)	Part Number
	120V AC	TWD-0126
	240V AC	TWD-0246
	480V AC	TWD-0486

6V secondary voltage (uses 6V lamp).

Pilot Lights (Assembled)



Assembled Pilot Lights

A P D 1 126 D N - R - ()

Function
P: Pilot Light

Series Designation
D: TWTD Series

Lens Shape
1: Dome

Rated Operational Voltage (Primary)
Transformer Type Full Voltage Type
126: 120V AC 99: Full Voltage
246: 240V AC
486: 480V AC

Lamp Voltage
(full voltage illuminated units only)

6V: 6V AC/DC
12V: 12V AC/DC
24V: 24V AC/DC
120V: 120V AC (LED only)
240V: 240V AC (LED only)

Lens Color Code

A: Amber
G: Green
R: Red
S: Blue
W: White
Y: Yellow

Lamp Type
Blank: Incandescent
D: LED

Use only when interpreting part numbers. Do not use for developing part numbers.

LED and Incandescent Pilot Lights

Style	Operating Voltage	Part Number	
		LED	Incandescent
 Transformer Dome	120V AC	APD1126DN-②	APD1126N-②
	240V AC	APD1246DN-②	APD1246N-②
	480V AC	APD1486DN-②	APD1486N-②
 Full Voltage Dome	—	APD199DN-②-③	APD199N-②-③

② Lens Color Codes

Color	Code
Amber	A
Green	G
Red	R
Blue	S
White	W
Yellow	Y

③ Full Voltage Codes

Voltage	Code
6V AC/DC	6V
12V AC/DC	12V
24V AC/DC	24V
120V AC	120V
240V AC	240V (LED only)

- 1. In place of ②, specify the Lens/LED Color Code.
- 2. In place of ③, specify the Full Voltage Code (lamp voltage).
- 3. Yellow pilot light comes with white LED.

Pilot Lights (Sub-Assembled)

Transformer* + Operator + Lamp + Lens = Complete Part



* Not required for full voltage units (full voltage clips used instead).

One Each from Left Column plus **One Selection from Right Column**

Operators

Style	Part Number
	APD-006
	APD-199

Full voltage operator comes with full voltage clips.

Lenses

Style	Part Number
	APN106LN-Ⓢ

1. In place of Ⓢ, specify the Lens Color Code.
2. LED and incandescent lenses differ in shade only. Some colors have only one shade.

Lamps

Style	Voltage	Part Number
	6V AC/DC	LSTD-6Ⓢ
	12V AC/DC	LSTD-1Ⓢ
	24V AC/DC	LSTD-2Ⓢ
	120V AC	LSTD-H2Ⓢ
	240V AC	LSTD-M4Ⓢ
	6V AC/DC	IS-6
	12V AC/DC	IS-12
	24V AC/DC	IS-24
	120V AC	L-120L

1. In place of Ⓢ, specify the LED color code.
2. The LED contains a current-limiting resistor and a protection diode.

Full Voltage Clips

Primary Voltage (50/60Hz)	Part Number
	APD-F

Required for all full voltage models. Two pieces each.

Transformers

Style	Primary Voltage (50/60Hz)	Part Number
	120V AC	TWD-0126
	240V AC	TWD-0246
	480V AC	TWD-0486

6V secondary voltage (use 6V lamp).

Ⓢ LED/Lens Color Codes

Color	Code
Amber	A
Green	G
Red	R
Blue	S
White	W
Yellow	Y

Yellow lens only. Yellow LED not available, use white LED.

Illuminated Pushbuttons (Assembled)

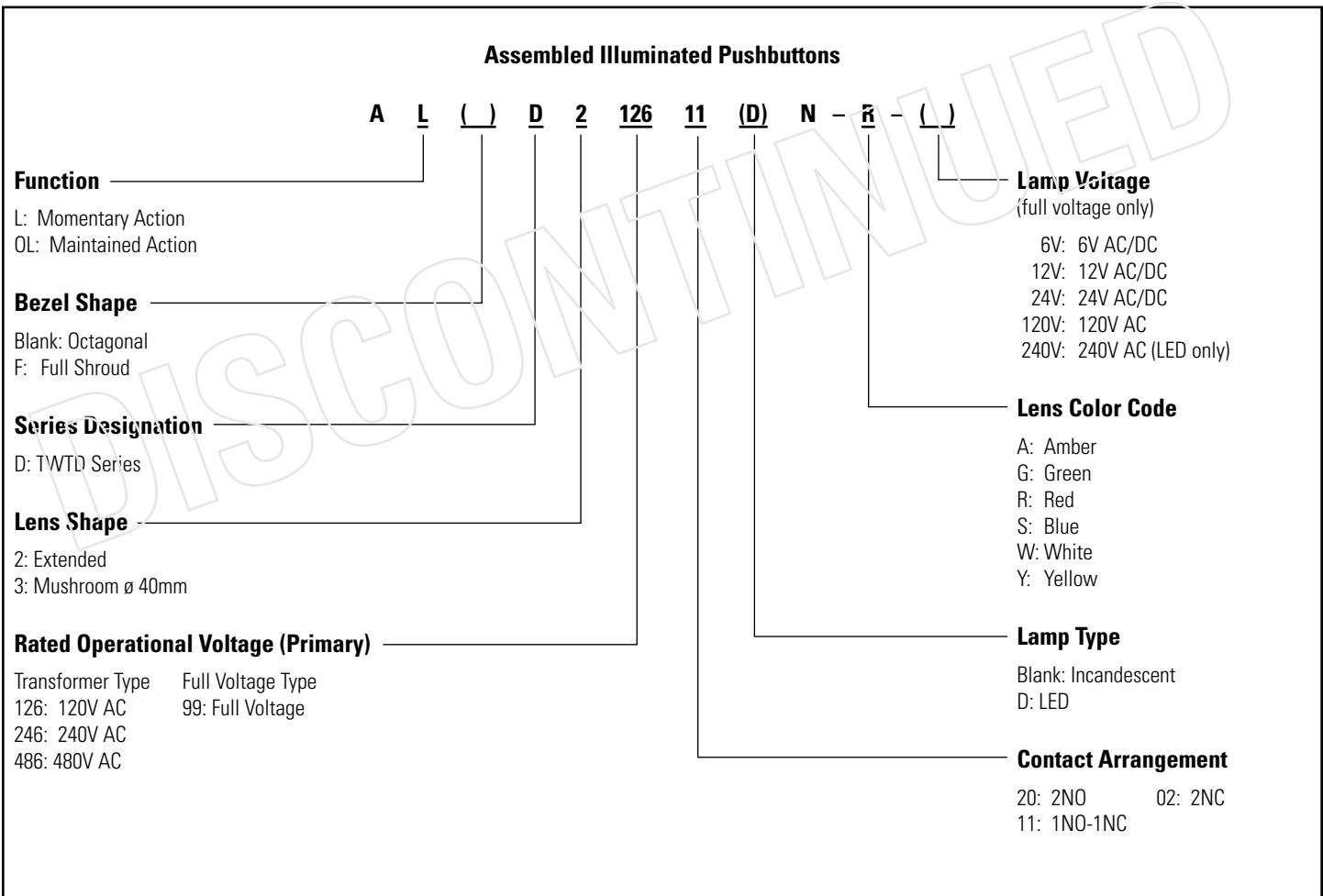

1. Use only when interpreting part numbers. Do not use for developing part numbers.
2. All transformers step down to 6V.

Illuminated Pushbuttons (Assembled)

Illuminated Pushbuttons

Style	Contacts	Part Number		
		Momentary	Maintained	
Extended Lens 	Full Voltage	1NO-1NC 2NO 2NC	ALD29911ⓈN-Ⓢ-Ⓢ ALD29920ⓈN-Ⓢ-Ⓢ ALD29902ⓈN-Ⓢ-Ⓢ	AOLD29911ⓈN-Ⓢ-Ⓢ AOLD29920ⓈN-Ⓢ-Ⓢ AOLD29902ⓈN-Ⓢ-Ⓢ
	Transformer	1NO-1NC 2NO 2NC	ALD2 Ⓢ 11ⓈN-Ⓢ ALD2 Ⓢ 20ⓈN-Ⓢ ALD2 Ⓢ 02ⓈN-Ⓢ	AOLD2 Ⓢ 11ⓈN-Ⓢ AOLD2 Ⓢ 20ⓈN-Ⓢ AOLD2 Ⓢ 02ⓈN-Ⓢ
Extended Lens with Full Shroud 	Full Voltage	1NO-1NC 2NO 2NC	ALFD29911ⓈN-Ⓢ-Ⓢ ALFD29920ⓈN-Ⓢ-Ⓢ ALFD29902ⓈN-Ⓢ-Ⓢ	AOLFD29911ⓈN-Ⓢ-Ⓢ AOLFD29920ⓈN-Ⓢ-Ⓢ AOLFD29902ⓈN-Ⓢ-Ⓢ
	Transformer	1NO-1NC 2NO 2NC	ALFD2 Ⓢ 11ⓈN-Ⓢ ALFD2 Ⓢ 20ⓈN-Ⓢ ALFD2 Ⓢ 02ⓈN-Ⓢ	AOLFD2 Ⓢ 11ⓈN-Ⓢ AOLFD2 Ⓢ 20ⓈN-Ⓢ AOLFD2 Ⓢ 02ⓈN-Ⓢ
ø 40mm Mushroom Lens 	Full Voltage	1NO-1NC 2NO 2NC	ALD39911ⓈN-Ⓢ-Ⓢ ALD39920ⓈN-Ⓢ-Ⓢ ALD39902ⓈN-Ⓢ-Ⓢ	AOLD39911ⓈN-Ⓢ-Ⓢ AOLD39920ⓈN-Ⓢ-Ⓢ AOLD39902ⓈN-Ⓢ-Ⓢ
	Transformer	1NO-1NC 2NO 2NC	ALD3 Ⓢ 11ⓈN-Ⓢ ALD3 Ⓢ 20ⓈN-Ⓢ ALD3 Ⓢ 02ⓈN-Ⓢ	AOLD3 Ⓢ 11ⓈN-Ⓢ AOLD3 Ⓢ 20ⓈN-Ⓢ AOLD3 Ⓢ 02ⓈN-Ⓢ

② Lens Color Codes

Color	Code
Amber	A
Green	G
Red	R
Blue	S
White	W
Yellow	Y

③ Full Voltage Codes

Voltage	Code
6V AC/DC	6V
12V AC/DC	12V
24V AC/DC	24V
120V AC	120V
240V AC	240V (LED only)

④ Transformer Voltage Codes

Voltage	Code
120VAC	126
240VAC	246
480VAC	486

 6V secondary voltage (uses 6V lamp).

⑤ Lamp Type Codes

Lamp	Code
Incandescent	Blank
LED	D

- 1. In place of Ⓢ, specify the Lens Color Code.
- 2. In place of Ⓢ, specify the Full Voltage Code (lamp voltage).
- 3. In place of Ⓢ, specify the Transformer Voltage Code.
- 4. In place of Ⓢ, specify the Lamp Type Code.
- 5. Light is independent of switch position.
- 6. Yellow pushbutton comes with white LED only.

Illuminated Pushbuttons (Sub-Assembled)

Transformer* + Contact Block + Operator + Lamp + Lens = Complete Part



*Not required for full voltage types (full voltage types use APD-F full voltage clips).

Operators

Style	Part Number	
	Momentary	Maintained
Extended	ALD-0600	AOLD-0600
Extended with Full Shroud	ALFD-0600	AOLFD-0600
40mm Mushroom	ALD-0600	AOLD-0600

Lenses

Style	Part Number
Extended	ALN06LU-Ⓞ
ø 40mm Mushroom	ALN3LU-Ⓞ

In place of Ⓞ, specify the Lens Color Code.

Full Voltage Clips

Style	Part Number
Full Voltage Clips (2 required for each unit)	APD-F

Required for all full voltage models.

Lamps

Style	Voltage	Part Number	Color	Code
LED	6V AC/DC	LSTD-6Ⓞ	Amber	A
	12V AC/DC	LSTD-1Ⓞ	Green	G
	24V AC/DC	LSTD-2Ⓞ	Red	R
	120V AC	LSTD-H2Ⓞ	Blue	S
	240V AC	LSTD-M4Ⓞ	White	W
Incandescent	6V AC/DC	IS-6	Yellow	Y
	12V AC/DC	IS-12		
	24V AC/DC	IS-24		
	120V AC	L-120L		

Ⓞ LED/Lens Color Codes

- In place of Ⓞ, specify the LED color code.
- The LED contains a current-limiting resistor and a protection diode.

Contact Blocks

Style	Part Number	
	1NO	1NC
All Control Units	BST-010	BST-001
	BST-010S (early make)	BST-001S (late break)
Dummy Block	BST-D	

- Dummy blocks (no contacts) are used with an odd number of contact blocks.
- Combining BST-010S and BST-001S result in overlapping contacts (remain on, or closed, when switch is moved between two positions).

Transformers

Style	Primary Voltage (50/60Hz)	Part Number
Transformers	120V AC	TWD-0126
	240V AC	TWD-0246
	480V AC	TWD-0486

6V secondary voltage (use 6V lamp).

Non-Illuminated Selector Switches (Assembled)



Assembled Selector Switches

A S D 2 () () 11 N - ()

Function

S: Selector Switch

Series Designation

D: TWTD Series

Number of Positions

2: 2-Position
3: 3-Position

Spring Return Action

Blank: Maintained
1: Spring return from Right
2: Spring return from Left
3: 2-Way spring return from Left and Right

Circuit Number

(See Circuit # column of Selector Switch Contact Arrangement Chart on beginning on page 792.)

Contact Arrangement Code

10: 1NO 01: 1NC
20: 2NO 02: 2NC
40: 4NO 04: 4NC
11: 1NO-1NC 22: 2NO-2NC

Operator Style Code

Blank: Knob Operator
L: Lever Operator
K: Key Operator

- 1. Use only when interpreting part numbers. Do not use for developing part numbers.
- 2. Custom key removal codes available. Please contact IDEC for details.

Non-Illuminated Selector Switches (Assembled)

Non-Illuminated 2-Position Selector Switches

Style				Part Number				
Contact	Mounting	Operator Position			Maintained	Spring Return from Right	Spring Return from Left	
		L	R					
1NO	1	0	X	Knob	ASD210N	ASD2110N	ASD2210N	
	2	0	0		ASD2L10N	ASD21L10N	ASD22L10N	
					ASD2K10N	ASD21K10N	ASD22K10N	
1NC	1	X	0	Knob	ASD201N-116	ASD2101N-116	ASD2201N-116	
	2	0	0		ASD2L01N-116	ASD21L01N-116	ASD22L01N-116	
					ASD2K01N-116	ASD21K01N-116	ASD22K01N-116	
1NO 1NC	1	0	X	Knob	ASD211N	ASD2111N	ASD2211N	
	2	X	0		ASD2L11N	ASD21L11N	ASD22L11N	
					ASD2K11N	ASD21K11N	ASD22K11N	
2NO	1	0	X	Knob	ASD220N	ASD2120N	ASD2220N	
	2	0	X		ASD2L20N	ASD21L20N	ASD22L20N	
					ASD2K20N	ASD21K20N	ASD22K20N	
2NC	1	X	0	Knob	ASD202N-104	ASD2102N-104	ASD2202N-104	
	2	X	0		ASD2L02N-104	ASD21L02N-104	ASD22L02N-104	
					ASD2K02N-104	ASD21K02N-104	ASD22K02N-104	
2NO 2NC	1	0	X	Knob	ASD222N	ASD2122N	ASD2222N	
	2	X	0		ASD2L22N	ASD21L22N	ASD22L22N	
	3	0	X		Lever	ASD2K22N	ASD21K22N	ASD22K22N
	4	X	0					
2NO 2NC	1	0	X	Knob	ASD222N-111	ASD2122N-111	ASD2222N-111	
	2	0	X		ASD2L22N-111	ASD21L22N-111	ASD22L22N-111	
	3	X	0		Lever	ASD2K22N-111	ASD21K22N-111	ASD22K22N-111
	4	X	0					



- The truth table indicates the operating position of contact block when the operator is switched to that position.
X = On (closed contacts) 0 = Off (open contacts)
X-X = Overlapping Contacts: Remain on (closed contacts) when switch is moved between these two positions.
- All knob and lever selector switches come in black. Other colors are available by ordering the knob or lever separately.
- Custom contact arrangements available, see page 762.

Non-Illuminated 3-Position Selector Switches

Style					Part Number					
Contact	Mounting	Operator Position				Maintained	Spring Return from Right	Spring Return from Left	Spring Return Two-Way	
		L	C	R						
2NO	1	X	0	0	Knob	ASD320N	ASD3120N	ASD3220N	ASD3320N	
	2	0	0	X		ASD3L20N	ASD31L20N	ASD32L20N	ASD33L20N	
						ASD3K20N	ASD31K20N	ASD32K20N	ASD33K20N	
2NC	1	0	X	X	Knob	ASD302N	ASD3102N	ASD3202N	ASD3302N	
	2	X	X	0		ASD3L02N	ASD31L02N	ASD32L02N	ASD33L02N	
						ASD3K02N	ASD31K02N	ASD32K02N	ASD33K02N	
2NO 2NC	1	X	0	0	Knob	ASD322N	ASD3122N	ASD3222N	ASD3322N	
	2	0	0	X		ASD3L22N	ASD31L22N	ASD32L22N	ASD33L22N	
	3	0	X	X		Lever	ASD3K22N	ASD31K22N	ASD32K22N	ASD33K22N
	4	X	X	0						
2NO 2NC	1	X	0	X	Knob	ASD322N-309	ASD3122N-309	ASD3222N-309	ASD3322N-309	
	2	X	X	0		ASD3L22N-309	ASD31L22N-309	ASD32L22N-309	ASD33L22N-309	
	3	0	X	0		Lever	ASD3K22N-309	ASD31K22N-309	ASD32K22N-309	ASD33K22N-309
	4	0	0	X						
2NO 2NC	1	0	X	0	Knob	ASD322N-310	ASD3122N-310	ASD3222N-310	ASD3322N-310	
	2	0	0	X		ASD3L22N-310	ASD31L22N-310	ASD32L22N-310	ASD33L22N-310	
	3	0	X	0		Lever	ASD3K22N-310	ASD31K22N-310	ASD32K22N-310	ASD33K22N-310
	4	0	0	X						
4NO	1	X	0	0	Knob	ASD340N	ASD3140N	ASD3240N	ASD3340N	
	2	0	0	X		ASD3L40N	ASD31L40N	ASD32L40N	ASD33L40N	
	3	X	0	0		Lever	ASD3K40N	ASD31K40N	ASD32K40N	ASD33K40N
	4	0	0	X						
4NC	1	0	X	X	Knob	ASD304N	ASD3104N	ASD3204N	ASD3304N	
	2	X	X	0		ASD3L04N	ASD31L04N	ASD32L04N	ASD33L04N	
	3	0	X	X		Lever	ASD3K04N	ASD31K04N	ASD32K04N	ASD33K04N
	4	X	X	0						



Non-Illuminated Selector Switches (Sub-Assembled)

Contact Blocks + Operator + Knob or Lever* + Color Insert* = Complete Part†





- *Not needed with key type switches.
- *Knob type shown.

Operators

Style	Position	Description	Part Number
Knob/Lever 	2	Maintained	ASD200
		Spring return from right	ASD2100
		Spring return from left	ASD2200
Key 	3	Maintained, Cam 1	ASD300-1
		Maintained, Cam 2	ASD300-2
		Spring return from right, Cam 1	ASD3100-1
		Spring return from right, Cam 2	ASD3100-2
		Spring return from left, Cam 1	ASD3200-1
		Spring return from left, Cam 2	ASD3200-2
	3	Spring return from left/right, Cam 1	ASD3300-1
		Spring return from left/right, Cam 2	ASD3300-2
		Maintained	ASD2700-RA
		Spring return from right	ASD21K00-RL
		Spring return from left	ASD22K00
		Maintained, Cam 1	ASD3K00-1
Maintained, Cam 2	ASD3K00-2		
	3	Spring return from right, Cam 1	ASD31K00-1-RLC
		Spring return from right, Cam 2	ASD31K00-2-RLC
		Spring return from left, Cam 1	ASD32K00-1-RRC
		Spring return from left, Cam 2	ASD32K00-2-RRC
	3	Spring return from left/right, Cam 1	ASD33K00-1-RC
		Spring return from left/right, Cam 2	ASD33K00-2-RC

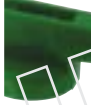
Handles and Inserts

Style	Part Number
Knob 	ASDHHY-⊙
Lever 	ASDHHL-⊙*
Color Insert 	TW-HC1-⊙



- In place of ⊙, specify the Color Code.
*Not available in yellow.

Contact Blocks

Style	Part Number	
	1NO	1NC
All Control Units 	BST-010	BST-001
	BST-010S (early make)	BST-001S (late break)
Dummy Block	BST-D	



- Dummy blocks (no contacts) are used with an odd number of contact blocks.
- Combining BST-010S and BST-001S result in overlapping contacts (remain on, or closed, when switch is moved between two positions).



- Order knobs, levers, color inserts separately (see below).
- For key switches, keys are removable in all maintained positions. Other options available, contact IDEC for details.
- See page 794 "Operator Truth Tables" for details of difference between cams.

① Color Codes

Knob/Lever Color	Code
Black	B
Blue	S
Green	G
Red	R
Yellow	Y
White	W



- Knob/Lever not available in white.
- Color inserts not available in Black.
- Lever not available in yellow.

Illuminated Selector Switches (Assembled)



Assembled Illuminated Selector Switches

A SL D 2 (2) 99 11 D N - 111 - R - 24

Function

SL: Illuminated Selector Switch

Series Designation

D: TWTD series

Number of Positions

2: 2-Position
3: 3-Position

Spring Return Action

Blank: Maintained
1: Spring return from Right
2: Spring return from Left
3: Two-Way spring return from Left and Right

Rated Operational Voltage (Primary)

Transformer Type	Full Voltage Type
126: 120V AC	99: Full Voltage
246: 240V AC	
486: 480V AC	

Contact Arrangement Code

20: 2NO	02: 2NC
40: 4NO	04: 4NC
11: 1NO-1NC	22: 2NO-2NC

Lamp Voltage

(Full Voltage Units Only)

6V: 6V AC/DC
12V: 12V AC/DC
24V: 24V AC/DC
120V: 120V AC
240V: 240V AC (LED only)

Lens Color Code

A: Amber
G: Green
R: Red
S: Blue
W: White
Y: Yellow

Circuit Code Number

See Circuit # column of Selector Switch Contact Arrangement Charts on page 792.

Lamp Type

Blank: Incandescent Lamp
D: LED Lamp

 Use only when interpreting part numbers. Do not use for developing part numbers.

Illuminated Selector Switches (Assembled)

Illuminated 2-Position Selector Switches

Style					Part Number		
Contact	Mounting	Operator Position		Lamp Circuit Type	Maintained	Spring Return from Right	Spring Return from Left
		L	R				
1NO	1	0	X	Transformer	ASLD2 ④11⑤N-②	ASLD21 ④11⑤N-②	ASLD22 ④11⑤N-②
1NC	2	X	0	Full Voltage	ASLD29911⑤N-②-③	ASLD219911⑤N-②-③	ASLD229911⑤N-②-③
2NO	1	0	X	Transformer	ASLD2 ④20⑤N-②	ASLD21 ④20⑤N-②	ASLD22 ④20⑤N-②
	2	0	X	Full Voltage	ASLD29920⑤N-②-③	ASLD219920⑤N-②-③	ASLD229920⑤N-②-③
2NC	1	X	0	Transformer	ASLD2 ④02⑤N-104-②	ASLD21 ④02⑤N-104-②	ASLD22 ④02⑤N-104-②
	2	X	0	Full Voltage	ASLD29902⑤N-104-②-③	ASLD219902⑤N-104-②-③	ASLD229902⑤N-104-②-③
2NO	1	0	X	Transformer	ASLD2 ④22⑤N-②	ASLD21 ④22⑤N-②	ASLD22 ④22⑤N-②
2NC	2	X	0				
2NC	3	0	X				
	4	X	0	Full Voltage	ASLD29922⑤N-②-③	ASLD219922⑤N-②-③	ASLD229922⑤N-②-③
2NO	1	0	X	Transformer	ASLD2 ④22⑤N-111-②	ASLD21 ④22⑤N-111-②	ASLD22 ④22⑤N-111-②
2NC	2	0	X				
2NC	3	X	0				
	4	X	0	Full Voltage	ASLD29922⑤N-111-②-③	ASLD219922⑤N-111-②-③	ASLD229922⑤N-111-②-③

② LED/Lens Color Codes

Color	Code
Amber	A
Green	G
Red	R
Blue	S
White	W
Yellow	Y

③ Full Voltage Codes

Voltage	Code
6V AC/DC	6V
12V AC/DC	12V
24V AC/DC	24V
120V AC	120V
240V AC	240V (LED only)

Illuminated 3-Position Selector Switches, Maintained and Spring Return

Style					Part Number				
Contact	Mounting	Operator Position			Lamp Circuit Type	Maintained	Spring Return From Right	Spring Return from Left	Spring Return Two-Way
		L	C	R					
2NO	1	X	0	0	Transformer	ASLD3 ④ 20⑤N-②	ASLD31 ④ 20⑤N-②	ASLD32 ④ 20⑤N-②	ASLD33 ④ 20⑤N-②
	2	0	0	X	Full Voltage	ASLD39920⑤N-②-③	ASLD319920⑤N-②-③	ASLD329920⑤N-②-③	ASLD339920⑤N-②-③
2NC	1	0	X	X	Transformer	ASLD3 ④ 02⑤N-②	ASLD31 ④ 02⑤N-②	ASLD32 ④ 02⑤N-②	ASLD33 ④ 02⑤N-②
	2	X	X	0	Full Voltage	ASLD39902⑤N-②-③	ASLD319902⑤N-②-③	ASLD329902⑤N-②-③	ASLD339902⑤N-②-③
2NO	1	X	0	0	Transformer	ASLD3 ④ 22⑤N-②	ASLD31 ④ 22⑤N-②	ASLD32 ④ 22⑤N-②	ASLD33 ④ 22⑤N-②
2NC	2	0	0	X					
2NC	3	0	X	X					
	4	X	X	0	Full Voltage	ASLD39922⑤N-②-③	ASLD319922⑤N-②-③	ASLD329922⑤N-②-③	ASLD339922⑤N-②-③
2NO	1	X	0	0	Transformer	ASLD3 ④ 22⑤N-309-②	ASLD31 ④ 22⑤N-309-②	ASLD32 ④ 22⑤N-309-②	ASLD33 ④ 22⑤N-309-②
2NC	2	X	X	X					
2NC	3	0	X	0					
	4	0	0	X	Full Voltage	ASLD39922⑤N-309-②-③	ASLD319922⑤N-309-②-③	ASLD329922⑤N-309-②-③	ASLD339922⑤N-309-②-③
2NO	1	0	X	0	Transformer	ASLD3 ④ 22⑤N-310-②	ASLD31 ④ 22⑤N-310-②	ASLD32 ④ 22⑤N-310-②	ASLD33 ④ 22⑤N-310-②
2NC	2	0	0	X					
2NC	3	0	X	0					
	4	0	0	X	Full Voltage	ASLD39922⑤N-310-②-③	ASLD319922⑤N-310-②-③	ASLD329922⑤N-310-②-③	ASLD339922⑤N-310-②-③
4NO	1	X	0	0	Transformer	ASLD3 ④ 40⑤N-②	ASLD31 ④ 40⑤N-②	ASLD32 ④ 40⑤N-②	ASLD33 ④ 40⑤N-②
	2	0	0	X					
	3	X	0	0					
	4	0	0	X	Full Voltage	ASLD39940⑤N-②-③	ASLD319940⑤N-②-③	ASLD329940⑤N-②-③	ASLD339940⑤N-②-③
4NC	1	0	X	X	Transformer	ASLD3 ④ 04⑤N-②	ASLD31 ④ 04⑤N-②	ASLD32 ④ 04⑤N-②	ASLD33 ④ 04⑤N-②
	2	X	X	0					
	3	0	X	X					
	4	X	X	0					

- In place of ②, specify the Lens/LED Color Code, in place of ③, specify the Full Voltage (lamp voltage) Code, in place of ④, specify the Transformer Voltage Code and in place of ⑤ specify the Lamp Type Code.
- The truth table indicates the operating position of contact block when the operator is switched to that position.
X = On (Closed Contacts) 0 = Off (Open Contacts)
X-X = Overlapping Contacts: Remain on (closed contacts) when switch is moved between these positions
- Yellow selector switch comes with white LED.

④ Transformer Voltage Codes

Voltage	Code
120VAC	126
240VAC	246
480VAC	486

Transformers step down to 6V (use 6V lamp).

⑤ Lamp Type Codes

Lamp	Code
Incandescent	Blank
LED	D

Light is independent of switch position.

Illuminated Selector Switches (Sub-Assembled)



*Not required for full voltage units (use APD-F full voltage clips instead).

Operators

Style	Position	Description	Part Number
Operator 	2	Maintained	ASLD200
	3	Maintained, Cam 1	ASLD300-1
		Maintained, Cam 2	ASLD300-2
	2	Spring return from right	ASLD2100
		Spring return from left	ASLD2200
	3	Spring return from right, Cam 1	ASLD3100-1
		Spring return from right, Cam 2	ASLD3100-2
		Spring return from left, Cam 1	ASLD3200-1
Spring return from left, Cam 2		ASLD3200-2	
	Spring return from left/right, Cam 1	ASLD3300-1	
	Spring return from left/right, Cam 2	ASLD3300-2	

Contact Blocks

Style	Part Number	Part Number	
		1NO	1NC
All Control Units 	BST-010	BST-001	
	BST-010S (early make)	BST-001S (late break)	
Dummy Block	BST-D		



- Dummy blocks (no contacts) are used with an odd number of contact blocks.
- Combining BST-010S and BST-001S result in overlapping contacts (remain on, or closed, when switch is moved between two positions).

Full Voltage Clips

Style	Part Number
Full Voltage Clips (2 required for each unit) 	APD-F



Required for all full voltage models.

Transformers

Style	Primary Voltage (50/60Hz)	Part Number
Transformers 	120V AC	TWD-0126
	240V AC	TWD-0246
	480V AC	TWD-0486



6V secondary voltage.

② LED/Lens Color Codes

Color	Code	Color	Code
Amber	A	Blue	S
Green	G	White	W
Red	R	Yellow	Y





Yellow lens only. Yellow LED not available, use white LED.

Lenses

Style	Part Number
Knob 	ASLNHU-①

Lamps

Style	Voltage	Part Number
LED 	6V AC/DC	LSTD-6②
	12V AC/DC	LSTD-1②
	24V AC/DC	LSTD-2②
	120V AC	LSTD-H2②
	240V AC	LSTD-M4②
Incandescent 	6V AC/DC	IS-6
	12V AC/DC	IS-12
	24V AC/DC	IS-24
	120V AC	L-120L



- In place of ②, specify the LED color code.
- The LED contains a current-limiting resistor and a protection diode.

Contact Arrangement Charts

How to Read Contact Arrangement Charts

To determine contact block mounting position, first make sure the selector switch is oriented as shown on the right

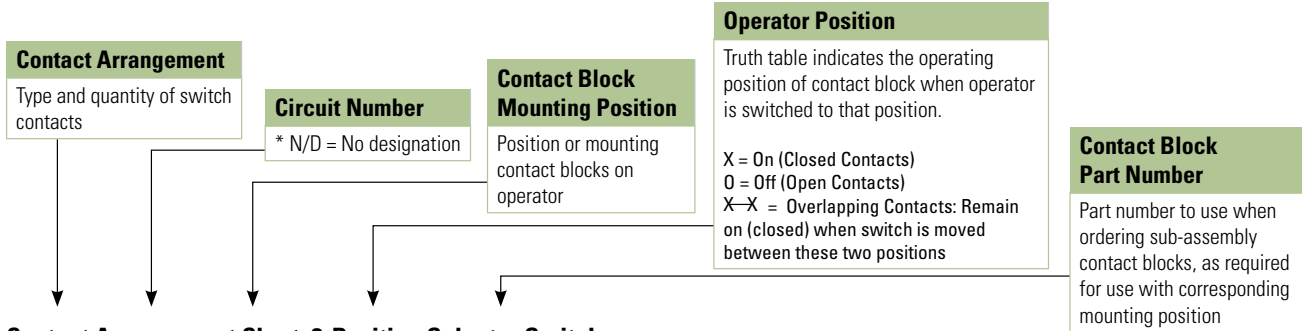

Contact Arrangement Chart: 2-Position Selector Switches

Style		Mounting Position	Operator Position		Contact Block Part Number	Description	Operator Part Number		
Contact	Circuit Number		L	R			Maintained	Spring Return from Right	Spring Return from Left
							L	R	L
1NO	N/D	1	O	X	BST-010	Knob/Lever Key	ASD200 ASD2K00 ASLD200	ASD2100 ASD21K00 ASLD2100	ASD2200 ASD22K00 ASLD2200
		2	O	O	BST-D	Illuminated Knob			
1NC	116	1	X	O	BST-001	Knob/Lever Key	ASD200 ASD2K00 ASLD200	ASD2100 ASD21K00 ASLD2100	ASD2200 ASD22K00 ASLD2200
		2	O	O	BST-D	Illuminated Knob			
1NO 1NC	N/D	1	O	X	BST-010	Knob/Lever Key	ASD200 ASD2K00 ASLD200	ASD2100 ASD21K00 ASLD2100	ASD2200 ASD22K00 ASLD2200
		2	X	O	BST-001	Illuminated Knob			
1NO-EM 1NC-LB	103	1	X	O	BST-001	Knob/Lever Key	ASD200 ASD2K00 ASLD200	ASD2100 ASD21K00 ASLD2100	ASD2200 ASD22K00 ASLD2200
		2	O	X	BST-010	Illuminated Knob			
	600	1	O	X	BST-010S	Knob/Lever Key	ASD200 ASD2K00 ASLD200	ASD2100 ASD21K00 ASLD2100	ASD2200 ASD22K00 ASLD2200
		2	X	O	BST-001S	Illuminated Knob			
601	1	X	O	BST-001S	Knob/Lever Key	ASD200 ASD2K00 ASLD200	ASD2100 ASD21K00 ASLD2100	ASD2200 ASD22K00 ASLD2200	
	2	O	X	BST-010S	Illuminated Knob				
2NO	N/D	1	O	X	BST-010	Knob/Lever Key	ASD200 ASD2K00 ASLD200	ASD2100 ASD21K00 ASLD2100	ASD2200 ASD22K00 ASLD2200
		2	O	X	BST-010	Illuminated Knob			
2NC	104	1	X	O	BST-001	Knob/Lever Key	ASD200 ASD2K00 ASLD200	ASD2100 ASD21K00 ASLD2100	ASD2200 ASD22K00 ASLD2200
		2	X	O	BST-001	Illuminated Knob			
2NO 2NC	N/D	1	O	X	BST-010	Knob/Lever Key	ASD200 ASD2K00 ASLD200	ASD2100 ASD21K00 ASLD2100	ASD2200 ASD22K00 ASLD2200
		2	X	O	BST-001	Illuminated Knob			
		3	O	X	BST-010	Knob/Lever Key	ASD200 ASD2K00 ASLD200	ASD2100 ASD21K00 ASLD2100	ASD2200 ASD22K00 ASLD2200
		4	X	O	BST-001	Illuminated Knob			
	110	1	X	O	BST-001	Knob/Lever Key	ASD200 ASD2K00 ASLD200	ASD2100 ASD21K00 ASLD2100	ASD2200 ASD22K00 ASLD2200
		2	O	X	BST-010	Knob/Lever Key	ASD200 ASD2K00 ASLD200	ASD2100 ASD21K00 ASLD2100	ASD2200 ASD22K00 ASLD2200
		3	X	O	BST-001	Illuminated Knob			
		4	O	X	BST-010	Illuminated Knob			
111	1	O	X	BST-010	Knob/Lever Key	ASD200 ASD2K00 ASLD200	ASD2100 ASD21K00 ASLD2100	ASD2200 ASD22K00 ASLD2200	
	2	O	X	BST-010	Knob/Lever Key	ASD200 ASD2K00 ASLD200	ASD2100 ASD21K00 ASLD2100	ASD2200 ASD22K00 ASLD2200	
	3	X	O	BST-001	Illuminated Knob				
	4	X	O	BST-001	Illuminated Knob				
4NO	N/D	1	O	X	BST-010	Knob/Lever Key	ASD200 ASD2K00 ASLD200	ASD2100 ASD21K00 ASLD2100	ASD2200 ASD22K00 ASLD2200
		2	O	X	BST-010	Knob/Lever Key	ASD200 ASD2K00 ASLD200	ASD2100 ASD21K00 ASLD2100	ASD2200 ASD22K00 ASLD2200
		3	O	X	BST-010	Knob/Lever Key	ASD200 ASD2K00 ASLD200	ASD2100 ASD21K00 ASLD2100	ASD2200 ASD22K00 ASLD2200
		4	O	X	BST-010	Illuminated Knob			

Contact Arrangement Chart: 3-Position Selector Switches

Style		Mounting Position	Operator Position			Contact Block Part Number	Description	Operator Part Number			
Contact	Circuit Number		L	C	R			Maintained	Spring Return from Right	Spring Return from Left	Two-Way
1NO 1NC	202	1	X	0	0	BST-010	Knob/Lever Key	ASD300-1	ASD3100-1	ASD3200-1	ASD3300-1
		2	X	X	0	BST-001	Illuminated Knob	ASD3K00-1 ASLD300-1	ASD31K00-1 ASLD3100-1	ASD32K00-1 ASLD3200-1	ASD33K00-1 ASLD3300-1
	203	1	0	X	X	BST-001	Knob/Lever Key	ASD300-1	ASD3100-1	ASD3200-1	ASD3300-1
		2	0	0	X	BST-010	Illuminated Knob	ASD3K00-1 ASLD300-1	ASD31K00-1 ASLD3100-1	ASD32K00-1 ASLD3200-1	ASD33K00-1 ASLD3300-1
	302	1	X	0	X	BST-010	Knob/Lever Key	ASD300-2	ASD3100-2	ASD3200-2	ASD3300-2
		2	X	X	0	BST-001	Illuminated Knob	ASD3K00-2 ASLD300-2	ASD31K00-2 ASLD3100-2	ASD32K00-2 ASLD3200-2	ASD33K00-2 ASLD3300-2
303	1	0	X	0	BST-001	Knob/Lever Key	ASD300-2	ASD3100-2	ASD3200-2	ASD3300-2	
	2	0	0	X	BST-010	Illuminated Knob	ASD3K00-2 ASLD300-2	ASD31K00-2 ASLD3100-2	ASD32K00-2 ASLD3200-2	ASD33K00-2 ASLD3300-2	
2NO	N/D	1	X	0	0	BST-010	Knob/Lever Key	ASD300-1	ASD3100-1	ASD3200-1	ASD3300-1
		2	0	0	X	BST-010	Illuminated Knob	ASD3K00-1 ASLD300-1	ASD31K00-1 ASLD3100-1	ASD32K00-1 ASLD3200-1	ASD33K00-1 ASLD3300-1
	301	1	X	0	X	BST-010	Knob/Lever Key	ASD300-2	ASD3100-2	ASD3200-2	ASD3300-2
		2	0	0	X	BST-010	Illuminated Knob	ASD3K00-2 ASLD300-2	ASD31K00-2 ASLD3100-2	ASD32K00-2 ASLD3200-2	ASD33K00-2 ASLD3300-2
2NC	304	1	0	X	0	BST-001	Knob/Lever Key	ASD300-2	ASD3100-2	ASD3200-2	ASD3300-2
		2	X	X	0	BST-001	Illuminated Knob	ASD3K00-2 ASLD300-2	ASD31K00-2 ASLD3100-2	ASD32K00-2 ASLD3200-2	ASD33K00-2 ASLD3300-2
	N/D	1	0	X	X	BST-001	Knob/Lever Key	ASD300-1	ASD3100-1	ASD3200-1	ASD3300-1
		2	X	X	0	BST-001	Illuminated Knob	ASD3K00-1 ASLD300-1	ASD31K00-1 ASLD3100-1	ASD32K00-1 ASLD3200-1	ASD33K00-1 ASLD3300-1
2NO 2NC	N/D	1	X	0	0	BST-010	Knob/Lever Key Illuminated Knob	ASD300-1 ASD3K00-1 ASLD300-1	ASD3100-1 ASD31K00-1 ASLD3100-1	ASD3200-1 ASD32K00-1 ASLD3200-1	ASD3300-1 ASD33K00-1 ASLD3300-1
		2	0	0	X	BST-010					
		3	0	X	X	BST-001					
		4	X	X	0	BST-001					
	210	1	0	X	X	BST-001	Knob/Lever Key Illuminated Knob	ASD300-1 ASD3K00-1 ASLD300-1	ASD3100-1 ASD31K00-1 ASLD3100-1	ASD3200-1 ASD32K00-1 ASLD3200-1	ASD3300-1 ASD33K00-1 ASLD3300-1
		2	0	0	X	BST-010					
		3	0	X	X	BST-001					
		4	0	0	X	BST-010					
	308	1	X	0	X	BST-010	Knob/Lever Key Illuminated Knob	ASD300-2 ASD3K00-2 ASLD300-2	ASD3100-2 ASD31K00-2 ASLD3100-2	ASD3200-2 ASD32K00-2 ASLD3200-2	ASD3300-2 ASD33K00-2 ASLD3300-2
		2	X	X	0	BST-001					
		3	X	0	X	BST-010					
		4	X	X	0	BST-001					
309	1	X	0	X	BST-010	Knob/Lever Key Illuminated Knob	ASD300-2 ASD3K00-2 ASLD300-2	ASD3100-2 ASD31K00-2 ASLD3100-2	ASD3200-2 ASD32K00-2 ASLD3200-2	ASD3300-2 ASD33K00-2 ASLD3300-2	
	2	X	X	0	BST-001						
	3	0	X	0	BST-001						
	4	0	0	X	BST-010						
310	1	0	X	0	BST-001	Knob/Lever Key Illuminated Knob	ASD300-2 ASD3K00-2 ASLD300-2	ASD3100-2 ASD31K00-2 ASLD3100-2	ASD3200-2 ASD32K00-2 ASLD3200-2	ASD3300-2 ASD33K00-2 ASLD3300-2	
	2	0	0	X	BST-010						
	3	0	X	0	BST-001						
	4	0	0	X	BST-010						

1. Each operator sub-assembly is available as a "-1" and a "-2" for 3-position selector switches. The internal cam of a "-1" is different from that of a "-2". This results in designated combinations of open and closed contacts in the various operator positions.
 2. N/D = No circuit number designation required in assembled part number.
 3. X = On (closed contacts) 0 = Off (open contacts). X-X Overlapping contacts remain on (closed) when switch is moved between these two positions.

Switches & Pilot Devices
 Signaling Lights
 Relays & Sockets
 Timers
 Contactors
 Terminal Blocks
 Circuit Breakers

Contact Arrangement Chart: 3-Position Selector Switches

Style		Mounting Position	Operator Position			Contact Block Part Number	Description	Operator Part Number			
Contact	Circuit Number		L	C	R			Maintained	Spring Return from Right	Spring Return from Left	Two-Way
4NO	N/D	1	X	0	0	BST-010	Knob/Lever Key Illuminated Knob	ASD300-1 ASD3K00-1 ASLD300-1	ASD3100-1 ASD31K00-1 ASLD3100-1	ASD3200-1 ASD32K00-1 ASLD3200-1	ASD3300-1 ASD33K00-1 ASLD3300-1
		2	0	0	X	BST-010					
		3	X	0	0	BST-010					
		4	0	0	X	BST-010					
	305	1	X	0	X	BST-010	Knob/Lever Key Illuminated Knob	ASD300-2 ASD3K00-2 ASLD300-2	ASD3100-2 ASD31K00-2 ASLD3100-2	ASD3200-2 ASD32K00-2 ASLD3200-2	ASD3300-2 ASD33K00-2 ASLD3300-2
		2	0	0	X	BST-010					
		3	X	0	X	BST-010					
		4	0	0	X	BST-010					
4NC	N/D	1	0	X	X	BST-001	Knob/Lever Key Illuminated Knob	ASD300-1 ASD3K00-1 ASLD300-1	ASD3100-1 ASD31K00-1 ASLD3100-1	ASD3200-1 ASD32K00-1 ASLD3200-1	ASD3300-1 ASD33K00-1 ASLD3300-1
		2	X	X	0	BST-001					
		3	0	X	X	BST-001					
		4	X	X	0	BST-001					
	314	1	0	X	0	BST-001	Knob/Lever Key Illuminated Knob	ASD300-2 ASD3K00-2 ASLD300-2	ASD3100-2 ASD31K00-2 ASLD3100-2	ASD3200-2 ASD32K00-2 ASLD3200-2	ASD3300-2 ASD33K00-2 ASLD3300-2
		2	X	X	0	BST-001					
		3	0	X	0	BST-001					
		4	X	X	0	BST-001					

- Each operator sub-assembly is available as a "-1" and a "-2" for 3-position selector switches. The internal cam of a "-1" is different from that of a "-2". This results in designated combinations of open and closed contacts in the various operator positions.
- N/D = No circuit number designation required in assembled part number.
- X = On (closed contacts) 0 = Off (open contacts). X-X Overlapping contacts remain on (closed) when switch is moved between these two positions.

Operator Truth Tables

Use the following tables to build custom selector switches.

2 Position Selector Switches

Contact	Mounting Position	Operator Position	
		Left	Right
ASD200	BST-010 (NO)	L	X
		R	X
	BST-001 (NC)	L	0
		R	0
BST-010S (NO-EM)	L	X-X	
	R	0	
BST-001S (NC-LB)	L	X-X	
	R	0	

3 Position Selector Switches

Contact	Mounting Position	Operator Position		
		Left	Center	Right
ASD300-1 ASLD300-1 ASD3K00-1	BST-010 (NO)	L	X	0
		R	0	X
	BST-001 (NC)	L	0	X-X
		R	X-X	0
	BST-010S (NO-EM)	L	X	0
		R	0	0
	BST-001S (NC-LB)	L	0	X-X
		R	X-X	0

3 Position Push/Pull Switches

Contact	Operator Position			
	Pull	Normal	Push	
AYLD22	BST-010 (NO)	0	0	X
	BST-001 (NC)	X	0	0
	BST-010S (NO-EM)	0	X	X
	BST-001S (NC-LB)	X	X	0

Contact	Mounting Position	Operator Position		
		Left	Center	Right
ASD300-2 ASLD300-2 ASD3K00-2	BST-010 (NO)	L	X	X
		R	0	X
	BST-001 (NC)	L	0	X
		R	X-X	0
	BST-010S (NO-EM)	L	X	X
		R	0	0
	BST-001S (NC-LB)	L	0	X
		R	X-X	0

Accessories – TWTD Series

TWTD Series Accessories

Item	Appearance	Description/Usage	Part Number
Lamp Removal Tool		Rubber tool used to install or remove LED's and incandescent lamps	OR-55
Metal Bezel		Standard octagonal units (chrome-pl.).	OG-81
		Extended, non-illuminated (chrome-pl.).	OG-82
		Extended, illuminated (chrome-pl.).	OG-83L
		Jumbo Mushroom Shallow Shroud	ABN4G
		Jumbo Mushroom Deep Shroud	ABN4F
Plastic Bezel		Black plastic locking ring/bezel	OGP11B
Boot/Cover		In place of ☉, specify Neoprene Rubber Boot color: B (black), G (green), R (red), Y (yellow)	OC-11 ☉
		Flush units (clear plastic -40° to +60°C).	OC-121
		Extended units (clear plastic -40° to +60°C).	OC-122
Anti-Rotation Ring		Plastic washer For nameplates or panels that should not be scratched.	OGL-D1T
		Thrus: washer/Anti-rotation ring for use with notched panel cutout.	OGL-D1S
Mounting Hole Plug		Plastic with locking nut attached.	OBP-11
		Metal with locking nut attached	OB-11
		Grey rubber (-5° to +60°C)	OB-13
Terminal Tab Adaptor		Tab #250 17/64" x 3/64" (6.35mm x 0.8mm): Single tab	TW-FA1
Full Voltage Adaptor		Used on all full voltage illuminated units. Two required per unit. (M3.5 screw and saddle)	APD-F
Lock Out Adaptor		Used to provide lockout protection for TWTD pushbuttons and knob selectors. ø 1-13/64" (30mm)	OL-KL1
Replacement Keys		Pair of keys (#0)	TW-SK

Switches & Pilot Devices

Signaling Lights

Relays & Sockets

Timers

Contactors

Terminal Blocks

Circuit Breakers

Fingersafe Covers for TWTD Series

Item	Description	Used with	Part Number
	Fingersafe terminal cover, for full voltage pilot lights, adds 3mm to overall depth	APD199... full voltage pilot lights	APD-PVL
	Fingersafe terminal cover, for contact blocks, adds 3mm to overall depth	Non-Illuminated pushbuttons ABD..., and AOD...	N-VL2
	Fingersafe terminal cover, adds 1.5mm to overall depth	Transformer pilot lights and illuminated units	N-VL3
	Fingersafe terminal cover, adds 4 mm to depth	Full voltage illuminated pushbuttons	N-VL4

Nameplates – TWTD Series

Faceplates

	NALD	NAKD	NAQD	HNAV
Dimensions				
Description	Part Number			
Nameplate (blank)	NALD-B (black) NALD-R (red)	NAKD-B (black) NAKD-R (red)	NAQD-B (black) NAQD-R (red)	HNAV-0
Nameplate (engraved)	NALD-⓪	NAKD-⓪	NAQD-⓪	HNAV-27 "Emergency Stop"

- 1. Nameplates are made of 0.031" aluminum. Lettering is white letters engraved on black background.
- 2. In place of ⓪, insert either the standard legend code from table below or custom engraving delimited by " ".
- 3. HNAV available in yellow only.

Standard Legend Codes

Pushbuttons		Pushbuttons/Selector Switches				Selector Switches	
Legend	Code	Legend	Code	Legend	Code	Legend	Code
AUTO	101	OPEN	116	AUTO-MAN	201	AUTO-MAN-OFF	301
CLOSE	102	CUT	117	CLOSE-OPEN	202	AUTO-OFF-MAN	302
DOWN	103	RAISE	118	DOWN-UP	203	CLOSE-OFF-OPEN	303
EMERG.STOP*	104	RESET	119	FAST-SLOW	204	DOWN-OFF-SLOW	304
FAST	105	REVERSE	120	FOR-REV	205	FAST-OFF-SLOW	305
FORWARD	106	RUN	121	HAND-AUTO	206	FOR-OFF-REV	306
HAND	107	SLOW	122	HIGH-LOW	207	LEFT-OFF-RIGHT	307
HIGH	108	START	123	JOG-RUN	208	LOWER-OFF-RAISE	308
IN	109	STOP*	124	LEFT-RIGHT	209	OFF-MAN-AUTO	309
INCH	110	STOP	125	LOWER-RAISE	210	OFF-SLOW-FAST	310
JOG	111	TEST	126	MAN-AUTO	211	OFF-1-2	311
LOW	112	UP	127	OFF-ON	212	OPEN-OFF-CLOSE	312
LOWER	113	I (Int'l On)	150	ON-OFF	213	SLOW-OFF-FAST	313
OFF	114	O (Int'l Off)	151	OPEN-CLOSE	214	SUMMER-OFF-WINTER	314
ON	115	EMO	152	RAISE-LOWER	215	UP-OFF-DOWN	315
						1-OFF-2	316
						HAND-OFF-AUTO	317

- 1. *Available in Red as standard legend code 104 and 124. To order engraved nameplate and codes, add legend code to nameplate part number. Character height based on the number of characters, space and size of nameplate. Standard character size is 3/16".
- 2. Nameplates with standard legends are the same list price as blank nameplates. Special engravings, additional cost.

To specify engraving instructions, use the Nameplate order form on next page.

Switches & Pilot Devices

Signaling Lights

Relays & Sockets

Timers

Contactors

Terminal Blocks

Circuit Breakers

Custom engraved Nameplates Order Form – TWTD Series

Copy this order form and use it to specify Letter Height, Custom Engravings, Location of Engraving on Nameplate, and Quantity Desired.

To ensure engraving accuracy, fax it to your IDEC representative, or Distributor.

Your Company Name: _____

IDEC Rep/Distributor Contact: _____

Your Name: _____

PO number (if known): _____

Telephone: _____

IDEC Rep/Distributor Phone: _____

Fax & Email: _____

IDEC Rep/Distributor Fax & Email: _____

NALD Nameplate

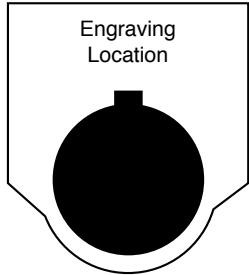

Step 1.

Choose Letter Size - 7/64" or 1/8".

Check the box for the letter size you want. Then write your lettering in box below checkboxes. Note: 1/8" size letters cannot exceed 13 characters.

Sample Letter Sizes

7/64" Letters: A B C D

1/8" Letters: A B C D

7/64"
Letter Size

16 characters max
(for 7/64" size letters)

1/8"
Letter Size

13 characters max
(for 1/8" size letters)

Step 2.

Specify Quantity.

Enter the number of nameplates desired in the box on the right.

Qty

NAKD Nameplate

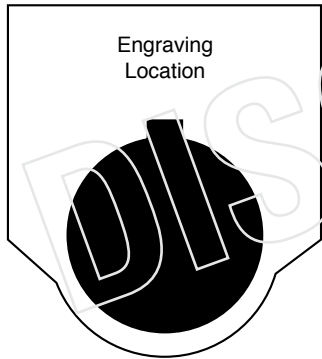

Step 1.

Choose Letter Size - 7/64" or 1/8".

Check the box for the letter size you want. Then write your lettering in box below checkboxes. Note: 1/8" size letters cannot exceed 9 characters.

Step 2.

Specify Quantity.

Enter the number of nameplates desired in the box on the right.

Qty

Sample Letter Sizes

1/8" Letters: A B C D

NAQD Nameplate

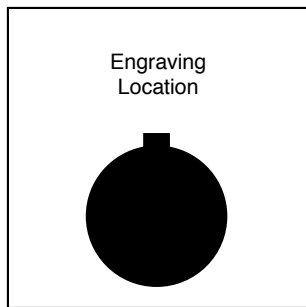

Step 1.

Choose Letter Size - 7/64" or 1/8".

Check the box for the letter size you want. Then write your lettering in box below checkboxes.

Note: 1/8" size letters cannot exceed 16 characters.

7/64"
Letter Size

20 characters max
(for 7/64" size letters)

1/8"
Letter Size

16 characters max
(for 1/8" size letters)

Step 2.

Specify Quantity.

Enter the number of nameplates desired in the box on the right.

Qty

Sample Letter Sizes

3/32" Letters: A B C D

1/8" Letters: A B C D

Switches & Pilot Devices

Signaling Lights

Relays & Sockets

Timers

Contactors

Terminal Blocks

Circuit Breakers

Switch Engraving Order Form – TWTD Series

Copy this order form and use it to specify Letter Height, Maximum Number of Lines and Text to be engraved.

To insure engraving accuracy, fax it to your IDEC representative or Distributor.

Your Company: _____
 Name: _____
 Address: _____
 PO: _____

Telephone: _____
 Fax: _____
 Email: _____
 Part Number to be Engraved: _____

Please check one of the boxes below to indicate your choice of engraving options:



ø29mm, ø40mm Mushroom Head

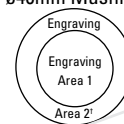

	# of Lines	Letter Height	Max. Characters Per Line
<input type="checkbox"/>	1	5/32	7
<input type="checkbox"/>		1/8	8
<input type="checkbox"/>	2	5/32	7
<input type="checkbox"/>		1/8	8
<input type="checkbox"/>	3	1/8	8
<input type="checkbox"/>	4	Custom*	

*Engraving is possible, but character size will be smaller than standard sizes.



	# of Lines	Letter Height	Max. Characters Per Line
<input type="checkbox"/>	1	5/32	7
<input type="checkbox"/>		1/8	8
<input type="checkbox"/>	2	5/32	7
<input type="checkbox"/>		1/8	8
<input type="checkbox"/>	3	1/8	8
<input type="checkbox"/>	4	Custom*	

*Engraving is possible, but character size will be smaller than standard sizes.

	# of Lines	Letter Height	Max. Characters Per Line
<input type="checkbox"/>	1	3/4	4
<input type="checkbox"/>		5/16	5
<input type="checkbox"/>	2	5/16	5
<input type="checkbox"/>		1/4	6
<input type="checkbox"/>	3	5/32	8
<input type="checkbox"/>	4	5/32	8
<input type="checkbox"/>		1/8	9
<input type="checkbox"/>	4	1/8	9

	# of Lines	Letter Height	Max. Characters Per Line
<input type="checkbox"/>	1	5/32	5
<input type="checkbox"/>		1/8	5
<input type="checkbox"/>	1	5/32	7
<input type="checkbox"/>		1/8	7



- Above mentioned specifications hold true for standard size push-buttons (round and square).
- *Engraving Area 2 can be engraved for 40mm mushroom head non-illuminated pushbutton only.
- Engraving is done on the button itself for non-illuminated push buttons and on marking plate for illuminated push buttons and pilot lights.
- Please enter text exactly how you want it engraved, take care to emphasize capital or small letters.

Enter text to be engraved:

Line 1: _____
 Line 2: _____
 Line 3: _____
 Line 4: _____

Sample Letter Sizes

1/8 Letters: **OPEN**

5/32 Letters: **OPEN**



All engraving is 5/8mm wide.

For IDEC Internal Use Only:

Work Order #: _____

Dimensions (mm)

Pushbutton

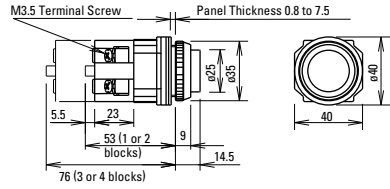

Mushroom Pushbutton w/Full Shroud

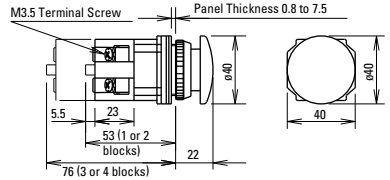

Pushbuttons	Dimension A	Dimension B
Flush	0.351" (9mm)	ø 0.975" (25mm)
Extended	0.566" (14.5mm)	ø 0.975" (25mm)
Extended w/Full Shroud	0.663" (17mm)	ø 1.11" (28.5mm)
Mushroom	0.858" (22mm)	ø 1.56" (40mm)
Mushroom w/Full Shroud	0.936" (24mm)	ø 1.87" (48mm)
Jumbo Mushroom	1.13" (29mm)	ø 2.54" (65mm)
Mushroom, Pushlock Turn Reset and Push-Pull	*0.975" (25mm) **0.975" (25mm)	ø 1.56" (40mm) ø 1.56" (40mm)



*Dimension when operator is in reset position.
**Dimension when operator is in pull position.

Illuminated Pushbuttons

w/Transformer

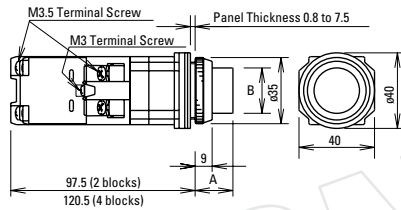

Full Voltage

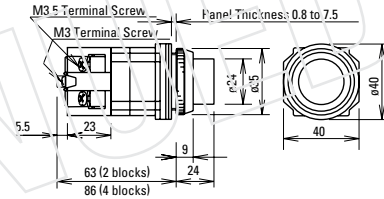

Illuminated Pushbuttons	Dimension A	Dimension B
Flush w/Full Shroud	0.375" (25mm) 0.935" (25.5mm)	ø 0.936" (24mm) ø 0.936" (24mm)
Extended w/Full Shroud	0.741" (19mm) 0.761" (19.5mm)	ø 0.936" (24mm) ø 0.936" (24mm)
ø 1.56" (40mm) Mushroom Pushlock Turn Reset, Push-Pull	*0.975" (25mm) **0.975" (25mm)	ø 1.56" (40mm) ø 1.56" (40mm)

Pilot Lights

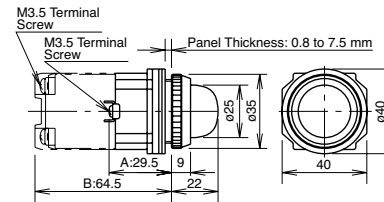

Selector Switches

Knob

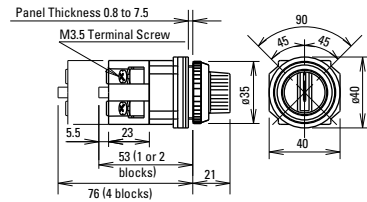

Lever

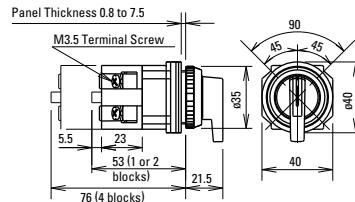

Key

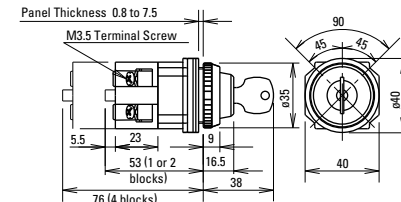

Illuminated Knob

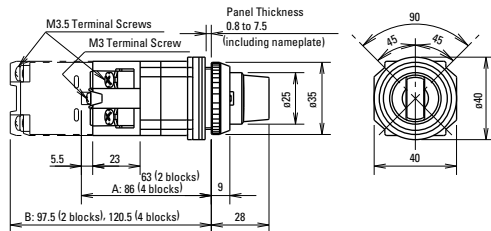

Operating Instructions

Adjustment for Panel Thickness

Each unit is shipped with several waterproof gaskets which are 0.06" (1.5mm) and 0.12" (3mm) thick. Combine the gaskets for a dimension approximately equal to panel thickness and install between the bezel and the body of the unit.

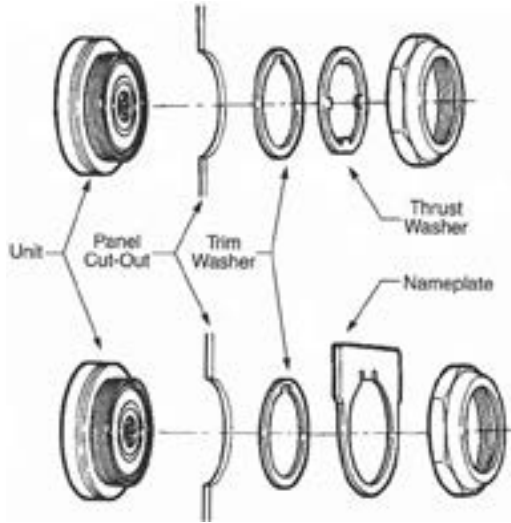

A trim washer must be used with a thrust washer or a nameplate to prevent the control unit from rotating in the mounting hole. When using anti-rotation rings (trim washer with thrust washer or nameplate), install as shown below.

Selector Switches

The operator shaft of each unit has a recess to identify in which direction to install the handle. Align the handle with the recess. Press color insert (TW-HC1) into the Standard Operating Positions.

Standard Operation Positions



Non-Illuminated 3-Position Operators

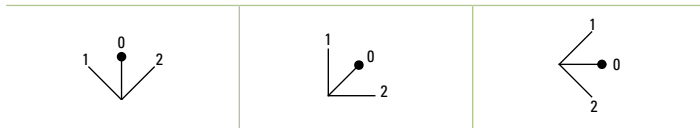

Installation of TWTD Series Units

TWTD Pilot Lights

TWTD Illuminated Pushbuttons
TWTD Selector Switches
(Transformer or Full Voltage)

Terminal X1 = Positive
Terminal X2 = Negative

Installation of LED Illuminated Units

Transformer units are recommended for use in areas subjected to inductive noise. When using full voltage types, install a protection diode as shown below. Use diode with DC power supply to protect against surges and noise.



Make sure that LED illuminated units are installed with correct polarity, as indicated at the terminals.

Application Example For Push-To-Test Pilot Light

A typical application of illuminated pushbuttons is a push-to-test pilot light which can be used to check the lamp/LED circuit.

Transformer/AC-Adapter Circuit

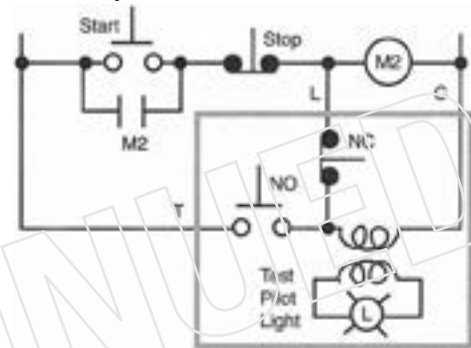

Full Voltage Circuit

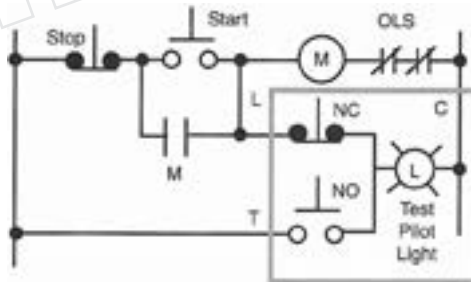

30mm Hazardous Location Switches EU2B Series: 30mm Hazardous Location Switches EC2B Series: Hazardous Location Control Stations

Key features:

- Pre-configured stations
- Custom-configured stations
- Open control boxes
- Mounting holes for up to 18 control units
- Class I, Zone 1/Division 2
- Applicable in explosive gas atmospheres (AEx de IIC T6 Gb)
- UL Type 4X rated
- Up to 3 contact blocks
- Selector switches available with lever or key
- Selector switches available with overlapping contacts
- Exposed and finger-safe (IP20) screw terminals available
- Corrosion resistant stainless steel enclosure (SUS304)
- Melamine coating
- NPT and Metric reducer options



Specifications

Standards Compliance

	Switches	Pilot Lights	Meters	Control Boxes
UL		Class I, Zone 1 AEx d e IIC T6 Gb Class I Div 2, Groups A, B, C and D		
c-UL	Class I, Zone 1, Ex de IIC T6 Gb Class I, Div 2, Groups A, B, C and D	Class I, Zone 1, Ex de IIB T6 Gb Class I, Div 2, Groups C and D	Class I, Zone 1, Ex de IIC T6 Gb Class I, Div 2, Groups A, B, C and D	
ATEX		Ex II2G Ex de IIC Gb Ex II2D Ex tb IIIC Db IP65		Ex d e IIC T6 Gb Ex tb IIIC T80°C Db (dust)
IECEX		Ex de IIC Gb Ex tb IIIC Db IP65		Ex de IIC T6 Gb Ex tb IIIC T80°C Db (dust)

Certificate Numbers

UL/c-UL	ATEX	IECEX
E347230	PTB 08 ATEX 1053 U PTB 08 ATEX 1003 U PTB 08 ATEX 1048	IECEX PTB 15.0006U IECEX PTB 15.0007U IECEX PTB 15.0032

Applicable Standards

Control Units	Standards	Mark
Pushbuttons Selector Switches Key Selector Switches Pilot Lights Meters	EN60947-5-1	CE
	UL60079-0 UL60079-1 UL60079-7	c UL US LISTED
	CAN/CSA C22.2 No. 60079-0 CAN/CSA C22.2 No. 60079-1 CAN/CSA C22.2 No. 60079-7	
	EN60079-0 EN60079-1 EN60079-7 EN60079-31	Ex
	IEC60079-0 IEC60079-1 IEC60079-7 IEC60079-31	IECEX
Emergency Stop Switches	EN60947-5-5	TUV

General Specifications

Degree of Protection	IP65 (IEC60529), Type 4X	
Insulation Resistance	100 MΩ minimum (500V DC megger)	
Operating Temperature	-20 to +50°C (no freezing)	
Operating Humidity	45 to 85% (no condensation)	
Altitude	2,000m Maximum	
Pollution Degree	3	
Shock Resistance	Operating Extremes	100-m/s ² Emergency Stop Switch: 150-m/s ² (without Meter)
	Damage Limits	1000-m/s ²
Vibration Resistance	Operating Extremes	5 to 55-Hz, amplitude 0.5 mm Emergency Stop Switch: 5 to 500-Hz, amplitude 0.35-mm, acceleration 50-m/s ² (without Meter)
	Damage Limits	30Hz, amplitude 1.5-mm Emergency Stop Switch: 5 to 500-Hz, amplitude 0.35-mm, acceleration 50-m/s ²

Switches

Rated Insulation Voltage	600V	
Contact Resistance	50mΩ maximum (initial value)	
Impulse Withstand Voltage (Uimp)	6kV	
Insulation Resistance	100MΩ minimum (500V DC megger)	
Short-Circuit Protection	250V/10A fuse (Type aM IEC60269-1/IEC60269-2)	
Conditional Short-Circuit Current	1,000A	
Mechanical Life	Pushbutton	1,000,000 operations minimum
	Selector Switch	500,000 operations minimum
	Key Selector Switch	500,000 operations minimum
	Emergency Stop Switch	50,000 operations minimum
Electrical Life	Pushbutton	250,000 (switching frequency 1800 operations/hr)
	Selector Switch	250,000 (switching frequency 900 operations/hr)
	Key Selector Switch	250,000 (switching frequency 900 operations/hr)
	Emergency Stop Switch	50,000 (switching frequency 900 operations/hr)
Minimum Operator Stroke Required for Direct Opening Action	Emergency Stop Switch	7.0mm
Maximum Operator Stroke	Emergency Stop Switch	9.0mm

Note: Contacts will bounce during operation of pushbuttons and selector switches (reference value: 20-ms). Be sure to take contact bounce time into consideration when designing a control circuit.

Contact Rating (Switches)

Rated Insulation Voltage (Ui)	600V					
Rated Thermal Current (Ith)	10A*					
Rated Operating Voltage (Ue)	24V	120V	240V	500V		
Rated Operating Current (Ie)	AC 50/60Hz	Resistive Load (AC12)	10A*	10A*	6A	2.8A
		Inductive Load (AC15)	10A*	6A	3A	1.4A
	DC	Resistive Load (DC12)	8A	2.2A	1.1A	—
		Inductive Load (DC13)	4A	1.1A	0.55A	—

Note: Up to 2 contacts (per control unit); 10A 3 contacts (per control unit); 9A Minimum applicable load: 3V AC/DC, 5mA Applicable operating locations may vary according to operating conditions and load types.

Contact Rating Code Designation	Thermal Continuous Test Current Amperes	Maximum current, Amperes								Maximum Volt-Amperes	
		120 Volt		240 Volt		480 Volt		600 Volt		600 Volt	
		Make	Break	Make	Break	Make	Break	Make	Break	Make	Break
A600	10	60	6.00	30	3.00	15	1.5	12	1.2	7200	720

Pilot Lights

Rated Insulation Voltage (Ui)		500V
Rated Operating Voltage (Ue)	Voltage	6V, 12V, 24V AC/DC
	Transformer	120V, 230V, 240V, 380V, 480V AC
Impulse Withstand Voltage (Uimp)		4kV
Insulation Resistance		100 MΩ minimum (500V DC)
Frequency		50/60Hz
Power Consumption (approx.)	Full Voltage	0.3W
	Transformer	1.5W
Life (reference value)		Approx. 40,000 hours

Note: Because the built-in LED lamp is a high-brightness version, the lamp may light dimly due to induction even when power is off.

Meters

Accuracy Class		2.5
Insulation Resistance		100 MΩ minimum (500V DC megger)
AC ammeter	Rated Insulation Voltage (Ui)	300V
	Operation	Moving core
	Impulse Withstand Voltage (Uimp)	4kV
	Power Consumption	1VA
	Measurement	5A, 10A, 30A, 50A, etc
	Input (CT Ratio)	1A, 5A
	Extended Memory	3 times, etc
DC input meter	Rated Insulation Voltage (Ui)	150V
	Operation	Moving coil
	Impulse Withstand Voltage (Uimp)	2.5kV
	Input	0 to 10V DC, 4 to 20mA, etc.
	Power Consumption (DC ammeter)	0.01W
Consumption Current (DC voltmeter)		1mA

Note: Use a commercially available CT (current transformer) for all AC ammeters, and install the CT in a non-hazardous location.

Control Boxes

Degree of protection	IP65 (IEC60529), Type 4X	Agency Approvals	UL/c-UL, IECEx/ATEX certified	
Housing Material	Stainless steel (SUS304)	Applicable Enclosure	All enclosures except for 6 Control Units x 3 Column	
Standard Coating	Melamine 1-column: Outside coating 2-, 3-column: Inside and outside coating	Mounting Style	Wall Mount	
		Control Unit	Pilot Light	Yes ¹
Pushbutton	Yes			
Emergency Pushbutton	Yes			
Selector Switch	Yes			
Key Selector Switch	Yes			
Meter	Yes			
Rated Insulation Voltage	600V (with pilot light or ET2A-8PE screw terminal block: 500V) Meter AC input: 300V Meter DC input: 150V	Reducer Screw	NPT Thread (standard) Metric Thread	
		Degree of Protection	IP65, TYPE4X (UL)	
Insulation Resistance	100 MΩ minimum (500V DC megger)	Grounding Terminal Screw Material	Stainless Steel	
Operating Temperature	-20 to +50°C (no freezing)	Applicable Wire	Stranded Wire (mm ²)	1.5 to 2.5
Operating Humidity	45 to 85% (no condensation)		Solid Wire (mm ²)	1.2 to 1.6
Altitude	2000m maximum		Solid/Stranded Wire (AWG)	16-14

1: c-UL explosion protection is different when pilot light is installed.

Switches (Control Units)



Pushbuttons



Emergency Stop Switches



Pilot Lights



Selector Switches



Key Selector Switches



Meters

Pushbuttons

Operator (style / function)

- B1 : Flush pushbutton / Momentary
- B2 : Extended pushbutton / Momentary
- B3 : Mushroom pushbutton / Momentary

EU2B - YB1 11 F S - D

Contact arrangement

- 10 : 1NO 01 : 1NC
- 20 : 2NO 02 : 2NC
- 30 : 3NO 03 : 3NC
- 11 : 1NO-1NC 12 : 1NO-2NC
- 21 : 2NO-1NC

Button color

- Blank: Red, Green, Black, and White included
- Y : Yellow S : Blue

Terminals

- F : Finger-safe terminal (IP20)
- C : Exposed screw terminal

Pilot Lights

EU2B - YL1 22 F D R

Operator (style / function)

- L1 : Pilot Light / dome

Lens/LED Colors

- R : Red G : Green A : Amber
- Y : Yellow PW : White S : Blue

Operating voltage

- 126 : AC 120V (Transformer type)
- 246 : AC 240V (Transformer type)
- 386 : AC 380V (Transformer type)
- 486 : AC 480V (Transformer type)

- 66 : AC/DC 6V (Full voltage type)
- 11 : AC/DC 12V (Full voltage type)
- 22 : AC/DC 24V (Full voltage type)

Terminals

- F : Finger-safe terminal (IP20)
- C : Exposed screw terminal

Part Number	Style and Function	Contact Arrangement	Weight (Approx.)	① Button Color
EU2B-YB110④①-D	Flush Momentary	1NO	68g	① Blank - supplied with red, green, black, and white buttons For yellow or blue buttons, specify Y (yellow) or S (blue).
EU2B-YB101④①-D		1NC		
EU2B-YB111④①-D		1NO-1NC	92g	
EU2B-YB120④①-D		2NO		
EU2B-YB102④①-D		2NC		
EU2B-YB121④①-D		2NO-1NC		
EU2B-YB112④①-D	1NO-2NC	116g		
EU2B-YB130④①-D	3NO			
EU2B-YB103④①-D	3NC			
EU2B-YB210④①-D	Extended Momentary	1NO	70g	Specify a button color code in place of ① in the part number B : black G : green R : red S : blue W : white Y : yellow
EU2B-YB201④①-D		1NC		
EU2B-YB211④①-D		1NO-1NC	94g	
EU2B-YB220④①-D		2NO		
EU2B-YB202④①-D		2NC		
EU2B-YB221④①-D		2NO-1NC		
EU2B-YB212④①-D		1NO-2NC	118g	
EU2B-YB230④①-D		3NO		
EU2B-YB203④①-D	3NC			
EU2B-YB310④①-D	Mushroom Momentary	1NO	76g	Specify a button color code in place of ① in the part number B : black G : green R : red S : blue W : white Y : yellow
EU2B-YB301④①-D		1NC		
EU2B-YB311④①-D		1NO-1NC	101g	
EU2B-YB320④①-D		2NO		
EU2B-YB302④①-D		2NC		
EU2B-YB321④①-D		2NO-1NC		
EU2B-YB312④①-D		1NO-2NC	125g	
EU2B-YB330④①-D		3NO		
EU2B-YB303④①-D	3NC			

Note: ① Illumination Color. Specify a contact terminal style in place of ④ in the part number: F (Finger-safe terminal), C (Exposed screw terminal)

Note: ① Button Color. Specify a contact terminal style in place of ④ in the part number: F (Finger-safe terminal), C (Exposed screw terminal)

Emergency Stop Switches

EU2B - YBV3 11 F R

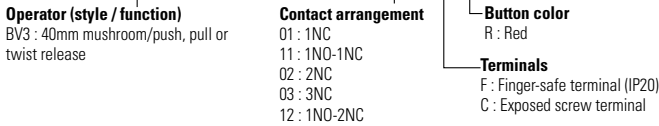

Part Number	Operator	Contact Arrangement	Weight (Approx.)	Button Color
EU2B-YBV301ⓄR	ø40 Mushroom	1NC	96g	R : Red
EU2B-YBV311ⓄR		1NO-1NC	120g	
EU2B-YBV302ⓄR		2NC		
EU2B-YBV312ⓄR		1NO-2NC	144g	
EU2B-YBV303ⓄR		3NC		

Specify a terminal style in place of Ⓞ in the part number: F (Finger-safe terminal), C (Exposed screw terminal)

Meters

EU2B - YM 5 3 A 10 F R

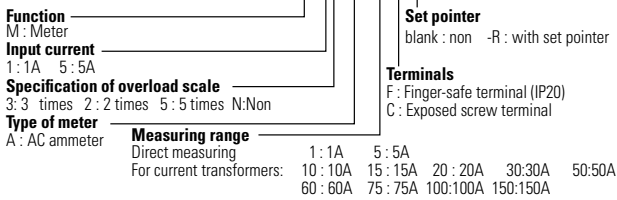

EU2B - YM 010 VD F-PER-R

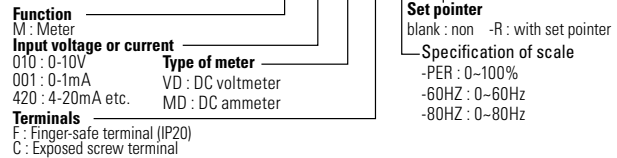

Input	Part Number	Description	Weight (approx.)
AC input meter (ammeter)	EU2B-YM53A5Ⓞ	Capacity: 5A Expansion scale: x3	270g
	EU2B-YM53A10Ⓞ	Capacity:10/5A Expansion scale: x3	
	EU2B-YM13A10Ⓞ	Capacity:10/1A Expansion scale: x3	
	EU2B-YM53A15Ⓞ	Capacity:15/5A Expansion scale: x3	
	EU2B-YM13A15Ⓞ	Capacity:15/1A Expansion scale: x3	
	EU2B-YM13A20Ⓞ	Capacity:20/1A Expansion scale: x3	
	EU2B-YM53A30Ⓞ	Capacity:30/5A Expansion scale: x3	
	EU2B-YM13A30Ⓞ	Capacity:30/1A Expansion scale: x3	
	EU2B-YM53A50Ⓞ	Capacity:50/5A Expansion scale: x3	
	EU2B-YM53A60Ⓞ	Capacity:60/5A Expansion scale: x3	
	EU2B-YM53A75Ⓞ	Capacity:75/5A Expansion scale: x3	
	EU2B-YM53A100Ⓞ	Capacity:100/5A Expansion scale: x3	
DC input meter	EU2B-YM010VDⓄ-PER	0-10V DC Input Scale: 0 to 100%	270g
	EU2B-YM010VDⓄ-60HZ	0-10V DC Input Scale: 0 to 60Hz	
	EU2B-YM001MDⓄ-PER	0-1mA DC Input Scale: 0 to 100%	
	EU2B-YM001MDⓄ-60HZ	0-1mA DC Input Scale: 0 to 60Hz	
	EU2B-YM001MDⓄ-80HZ	0-1mA DC Input Scale: 0 to 80Hz	
	EU2B-YM420MDⓄ-PER	4-20mA DC Input Scale: 0 to 100%	
EU2B-YM420MDⓄ-60HZ	4-20mA DC Input Scale: 0 to 60Hz		

Specify a terminal style in place of Ⓞ in the part number: F (Finger-safe terminal), C (Exposed screw terminal)

2 Position Selector Switches

EU2B - YSK 3 11 N1 F A

Operator (style / function)

S: Selector (Knob operator)
SK: Key selector (Key operator)

Number of Positions / Spring Return Action

2: 2-position / Maintained
2R: 2-position / Maintained (Overlap)
2J: 2-position / Maintained (Special function)
21: 2-position / Spring return from right
3: 3-position / Maintained
31: 3-position / Spring return from right
32: 3-position / Spring return from left
33: 3-position / Spring return two-way

Contact arrangement

10: 1NO 03: 3NC
11: 1NO-1NC 02: 2NC
01: 1NC 21: 2NO-1NC
30: 3NO 12: 1NO-2NC
20: 2NO

Key Removable Position

See option codes below

Terminals

F: Finger-safe terminal (IP20)
C: Exposed screw terminal

Circuit Number

Blank: No Designation
N*: See charts

Contact	Mounting	Selector Switches				Key Selector Switches			
		Operator Position		Maintained	Spring Return from Right	Maintained	Spring Return from Right		
		L	R	L R	L R	L R	L R		
NO	1		●	EU2B-YS210④	EU2B-YS2110④	EU2B-YSK210④③	EU2B-YSK2110④③		
				EU2B-YS201④	EU2B-YS2101④	EU2B-YSK201④③	EU2B-YSK2101④③		
NC	3	●		EU2B-YS220④	EU2B-YS2120④	EU2B-YSK220④③	EU2B-YSK2120④③		
NO	1		●	EU2B-YS202④	EU2B-YS2102④	EU2B-YSK202④③	EU2B-YSK2102④③		
NO	3	●	●	EU2B-YS211④	EU2B-YS2111④	EU2B-YSK211④③	EU2B-YSK2111④③		
NC	1	●		EU2B-YS230④	EU2B-YS2130④	EU2B-YSK230④③	EU2B-YSK2130④③		
NO	2		●	EU2B-YS203④	EU2B-YS2103④	EU2B-YSK203④③	EU2B-YSK2103④③		
NO	3	●	●	EU2B-YS221④	EU2B-YS2121④	EU2B-YSK221④③	EU2B-YSK2121④③		
NC	1	●		EU2B-YS212④	EU2B-YS2112④	EU2B-YSK212④③	EU2B-YSK2112④③		
NC	2	●	●	EU2B-YS2R11④	N/A	EU2B-YSK2R11④③	N/A		
NC	3	●							
NO	1	●							
NC	2	●	●						
NC	3	●							

Key is removable in all maintained positions. Specify key removal position in place of ③ in the part number. See table. Specify a terminal style in place of ④ in the part number: F (Finger-safe terminal), C (Exposed screw terminal).

2-position, 2-position/inverse cam

Selector Switch

Key Selector Switch

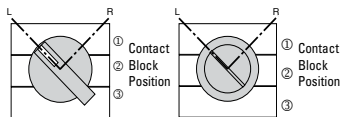

Contact	Mounting	Operator Position		Selector Switches	Key Selector Switches
		L	R	Maintained	Maintained
		L	R	L R	L R
NO	1	●		EU2B-YS2J10④	EU2B-YSK2J10④③
				EU2B-YS2J01④	EU2B-YSK2J01④③
NC	3		●	EU2B-YS2J20④	EU2B-YSK2J20④③
NO	1	●		EU2B-YS2J02④	EU2B-YSK2J02④③
NO	3	●	●	EU2B-YS2J11④	EU2B-YSK2J11④③
NC	1	●		EU2B-YS2J30④	EU2B-YSK2J30④③
NO	2	●	●	EU2B-YS2J12④	EU2B-YSK2J12④③
NO	3	●		EU2B-YS2J03④	EU2B-YSK2J03④③
NC	1		●	EU2B-YS2J21④	EU2B-YSK2J21④③
NC	2	●	●	EU2B-YS2J12④	EU2B-YSK2J12④③
NC	3		●		
NO	1	●			
NO	2	●			
NC	3		●		

③ Key Removable Option Codes (2-position)

A	Key removable in any position
B	Key removable in left position
C	Key removable in right position

3 Position Selector Switches

Contact	Mounting	Operator Position				Selector Switches				Key Selector Switches			
		L	C	R	Maintained	Spring Return from Right	Spring Return from Left	Spring Return Two Way	Maintained	Spring Return from Right	Spring Return from Left	Spring Return Two Way	
NO	1	●			EU2B-YS320④	EU2B-YS3120④	EU2B-YS3220④	EU2B-YS3320④	EU2B-YSK320④③	EU2B-YSK3120④③	EU2B-YSK3220④③	EU2B-YSK3320④③	
NO	3			●									
NO	2	●		●	EU2B-YS320N1④	EU2B-YS3120N1④	EU2B-YS3220N1④	EU2B-YS3320N1④	EU2B-YSK320N1④③	EU2B-YSK3120N1④③	EU2B-YSK3220N1④③	EU2B-YSK3320N1④③	
NO	3			●									
NC	1				EU2B-YS302④	EU2B-YS302④	EU2B-YS3202④	EU2B-YS3302④	EU2B-YSK302④③	EU2B-YSK302④③	EU2B-YSK3202④③	EU2B-YSK3302④③	
NC	3												
NC	2		●		EU2B-YS302N1④	EU2B-YS3102N1④③	EU2B-YS3202N1④③	EU2B-YS3302N1④	EU2B-YSK302N1④③	EU2B-YSK3102N1④③	EU2B-YSK3202N1④③	EU2B-YSK3302N1④③	
NC	3												
NO	1	●			EU2B-YS311④	EU2B-YS311④	EU2B-YS3211④	EU2B-YS3311④	EU2B-YSK311④③	EU2B-YSK311④③	EU2B-YSK3211④③	EU2B-YSK3311④③	
NC	3												
NC	1				EU2B-YS311N1④	EU2B-YS311N1④	EU2B-YS3211N1④	EU2B-YS3311N1④	EU2B-YSK311N1④③	EU2B-YSK311N1④③	EU2B-YSK3211N1④③	EU2B-YSK3311N1④③	
NO	3			●									
NO	1	●			EU2B-YS311N2④	EU2B-YS311N2④	EU2B-YS3211N2④	EU2B-YS3311N2④	EU2B-YSK311N2④③	EU2B-YSK311N2④③	EU2B-YSK3211N2④③	EU2B-YSK3311N2④③	
NC	2		●										
NC	1				EU2B-YS311N3④	EU2B-YS311N3①	EU2B-YS3211N3①	EU2B-YS3311N3①	EU2B-YSK311N3④③	EU2B-YSK311N3④③	EU2B-YSK3211N3④③	EU2B-YSK3311N3④③	
NO	3			●									
NO	2	●		●	EU2B-YS311N4④	EU2B-YS311N4④	EU2B-YS3211N4④	EU2B-YS3311N4④	EU2B-YSK311N4④③	EU2B-YSK311N4④③	EU2B-YSK3211N4④③	EU2B-YSK3311N4④③	
NC	3												
NO	1	●			EU2B-YS330④	EU2B-YS3130④	EU2B-YS3230④	EU2B-YS3330④	EU2B-YSK330④③	EU2B-YSK3130④③	EU2B-YSK3230④③	EU2B-YSK3330④③	
NO	2	●		●									
NO	3			●									
NC	1				EU2B-YS303④	EU2B-YS3103④	EU2B-YS3203④	EU2B-YS3303④	EU2B-YSK303④③	EU2B-YSK3103④③	EU2B-YSK3203④③	EU2B-YSK3303④③	
NC	2		●										
NC	3												
NO	1	●			EU2B-YS321N1④	EU2B-YS3121N1④	EU2B-YS3221N1④	EU2B-YS3321N1④	EU2B-YSK321N1④③	EU2B-YSK3121N1④③	EU2B-YSK3221N1④③	EU2B-YSK3321N1④③	
NC	2		●										
NO	3			●									
NC	1				EU2B-YS312N1④	EU2B-YS3112N1④	EU2B-YS3212N1④	EU2B-YS3312N1④	EU2B-YSK312N1④③	EU2B-YSK3112N1④③	EU2B-YSK3212N1④③	EU2B-YSK3312N1④③	
NO	2	●		●									
NC	3												

Specify a terminal style in place of ④ in the part number: F (Finger-safe terminal), C (Exposed screw terminal).

Key is removable in all maintained positions. Specify key removal position in place of ③ in the part number. See table.

3-position, 3-position/inverse cam

Selector Switch

Key Selector Switch

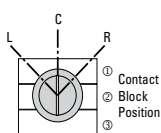
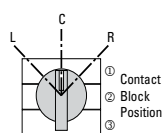

③ Key Removable Option Codes (3-Position)

A	Key removable in any position
B	Key removable in left and center positions
C	Key removable in center and right positions
D	Key removable in center position
E	Key removable in left and right positions
G	Key removable in left position
H	Key removable in right position

Switches & Pilot Devices

Signaling Lights

Relays & Sockets

Timers

Contactors

Terminal Blocks





Circuit Breakers

Control Boxes

1 Column

1 control unit	2 control units	3 control units	4 control units	5 control units
EC2B-B21B011N2⓪-U	EC2B-B21B021N2⓪-U	EC2B-B31B031N2⓪-U	EC2B-B51B041N3⓪-U	EC2B-B51B051N3⓪-U
				

2 Columns

4 control units	6 control units	8 control units	10 control units
EC2B-B32B042N2⓪-U	EC2B-B32B062N2⓪-U	EC2B-B52B082N3⓪-U	EC2B-B52B102N3⓪-U
			

3 Columns

6 control units	9 control units	12 control units	15 control units	18 control units
EC2B-B33B063N2⓪-U	EC2B-B33B093N2⓪-U	EC2B-B53B123N3⓪-U	EC2B-B53B153N3⓪-U	EC2B-B63B183N3⓪-U
				

Thread Size

Code	Description
M1	M16
M2	M20
M3	M25
M4	M32
M5	M40
N1	NPT1/2
N2	NPT3/4
N3	NPT1
N4	NPT1 1/4

⓪ Terminal Block Style

Code	Description
blank	no terminal block
C	Exposed screw terminals
F	Finger-safe terminals

Other thread size options available. To specify different thread sizes, use table at left to select a code to use in place of N2 or N3 in the part number.
Specify terminal block style in place of ⓪ in part number (standard versions do not contain a terminal block).

Standard Control Stations

1 Control Unit × 1 Column

1 Flash Pushbutton

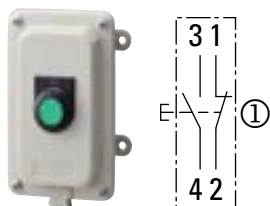

	EC2B-1102BN2N□1-U	EC2B-1102BN2N□2-U
①	Flush momentary 1NO contact Nameplate ON Button color: black, green, red, and white 1NO-1NC contact	Flush momentary 1NC contact Nameplate OFF Button color: black, green, red, and white

	EC2B-1102BN2N□3-U	EC2B-1102BN2N□4-U
①	Flush momentary 1NO-1NC contact Nameplate ON Button color: black, green, red, and white	Flush momentary 1NO-1NC contact Nameplate OFF Button color: black, green, red, and white

1 pilot light

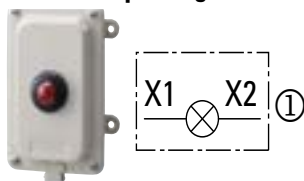

	EC2B-1101BN2□11-U	EC2B-1101BN2□12-U	EC2B-1101BN2□3-U
①	120V AC Illumination color: red	240V AC Illumination color: red	24V AC/DC Illumination color: red

	EC2B-1101BN2□13-U	EC2B-1101BN2□14-U	EC2B-1101BN2□6-U
①	120V AC Illumination color: green	240V AC Illumination color: green	24V AC/DC Illumination color: green

1 selector switch

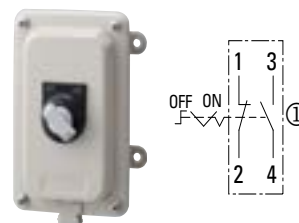

	EC2B-1106BN2N□1-U	
①	Knob selector 2-position maintained 1NO-1NC contact Name plate OFF-ON	

1 key selector switch

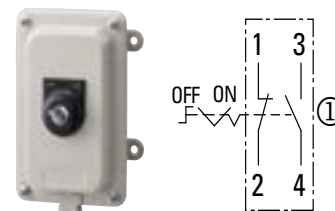

	EC2B-1106BN2N□4-U	
①	Key selector 2-position maintained (removable at all positions) 1NO-1NC contact Nameplate OFF-ON	

1 e-stop switch

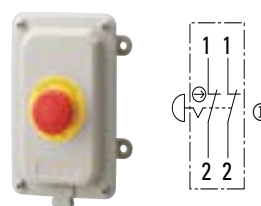

	EC2B-1102BN2N□7-U	
①	Emergency stop switch 2NC contact Nameplate EMERGENCY STOP Button color (red)	

2 Control Units × 1 Column

2 Control Units × 1 Column

2 flush pushbuttons

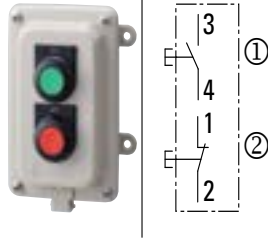

EC2B-2102BN2N□1-U	
①	Flush momentary 1NO contact, Nameplate ON Button color (black, green, red, white)
②	Flush momentary 1NC contact, Nameplate OFF Button color (black, green, red, white)

2 Mushroom Pushbuttons

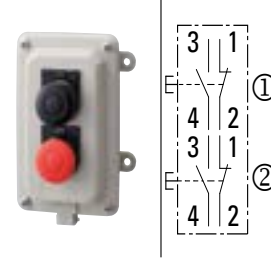

EC2B-2102BN2N□4-U	
①	Mushroom momentary 1NO-1NC contact, Nameplate ON Button color (black)
②	Mushroom momentary 1NO-1NC contact, Nameplate OFF Button color (red)

1 pilot light/1 pushbutton

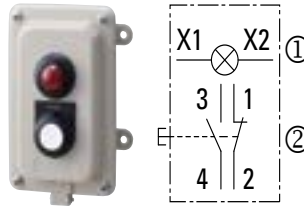



	EC2B-2110BN2N□5-U	EC2B-2110BN2N□6-U	EC2B-2110BN2N□3-U
①	120V AC Illumination color: red	240V AC Illumination color: red	24V AC/DC Illumination color: red
②	Flush momentary 1NO-1NC contact Name plate STOP Button color (black, green, red, white)	Flush momentary 1NO-1NC contact Name plate STOP Button color (black, green, red, white)	Flush momentary 1NO-1NC contact Name plate STOP Button color (black, green, red, white)

Specify terminal style code in place of □ in part no. C (standard screw terminal), F (finger-safe screw terminal)

2 Control Units × 1 Column

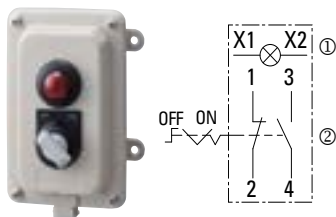
1 pilot light / 1 selector switch



	EC2B-2117BN2N□3-U	EC2B-2117BN2N□4-U
①	120V AC Illumination color: red	240V AC Illumination color: red
②	Knob, 2-position, 1NO-1NC contact Maintained, Name plate OFF-ON 	Knob, 2-position, 1NO-1NC contact Maintained, Name plate OFF-ON 

3 Control Units × 1 Column

1 pilot light / 2 pushbuttons

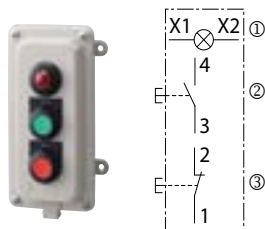

	EC2B-3110BN2N□5-U	EC2B-3110BN2N□6-U	EC2B-3110BN2N□3-U
①	120V AC Illumination color: red	240V AC Illumination color: red	24V AC/DC Illumination color: red
②	Flush momentary 1NO contact, Nameplate ON Button color (black, green, red, white)	Flush momentary 1NO contact, Nameplate ON Button color (black, green, red, white)	Flush momentary 1NO contact, Nameplate ON Button color (black, green, red, white)
③	Flush momentary 1NC contact, Nameplate OFF Button color (black, green, red, white)	Flush momentary 1NC contact, Nameplate OFF Button color (black, green, red, white)	Flush momentary 1NC contact, Nameplate OFF Button color (black, green, red, white)

3 pushbuttons

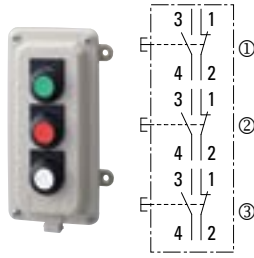

EC2B-3102BN2N□1-U	
①	Flush momentary 1NO-1NC contact, Blank nameplate Button color (black, green, red, white)
②	Flush momentary 1NO-1NC contact, Nameplate ON Button color (black, green, red, white)
③	Flush momentary 1NO-1NC contact, Nameplate OFF Button color (black, green, red, white)

1 meter / 2 pushbuttons

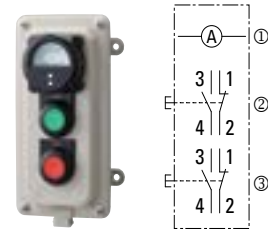

EC2B-3152BN2N□1△-U	
①	Specify input, capacity, and scale
②	Flush momentary 1NO-1NC contact, Nameplate ON Button color (black, green, red, white)
③	Flush momentary 1NO-1NC contact, Nameplate OFF Button color (black, green, red, white)

Specify the meter's capacity and scale in place of △ in the part number

4 Control Units × 1 Column

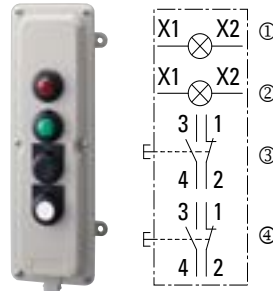

2 pilot lights / 2 pushbuttons

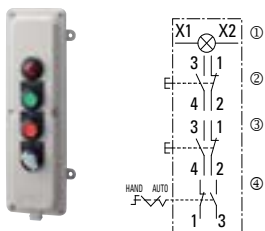

	EC2B-4110BN3N□5-U	EC2B-4110BN3N□6-U	EC2B-4110BN3N□3-U
①	120V AC, Illumination color: red	240V AC, Illumination color: red	24V AC/DC, Illumination color: red
②	120V AC, Illumination color: green	240V AC, Illumination color: green	24V AC/DC, Illumination color: green
③	Flush momentary 1NO-1NC contact, Nameplate ON Button color (black, green, red, white)	Flush momentary 1NO-1NC contact, Nameplate ON Button color (black, green, red, white)	Flush momentary 1NO-1NC contact, Nameplate ON Button color (black, green, red, white)
④	Flush momentary 1NO-1NC contact, Nameplate OFF Button color (black, green, red, white)	Flush momentary 1NO-1NC contact, Nameplate OFF Button color (black, green, red, white)	Flush momentary 1NO-1NC contact, Nameplate OFF Button color (black, green, red, white)

1 pilot light / 2 pushbuttons / 1 selector switch





	EC2B-4113BN3N□5-U	EC2B-4113BN3N□6-U	EC2B-4113BN3N□3-U
①	120V AC, Illumination color: red	240V AC, Illumination color: red	24V AC/DC, Illumination color: red
②	Flush momentary 1NO-1NC contact, Nameplate ON Button color (black, green, red, white)	Flush momentary 1NO-1NC contact, Nameplate ON Button color (black, green, red, white)	Flush momentary 1NO-1NC contact, Nameplate ON Button color (black, green, red, white)
③	Flush momentary 1NO-1NC contact, Nameplate OFF Button color (black, green, red, white)	Flush momentary 1NO-1NC contact, Nameplate OFF Button color (black, green, red, white)	Flush momentary 1NO-1NC contact, Nameplate OFF Button color (black, green, red, white)
④	Knob, 2-position, maintained 1NO-1NC contact Nameplate HAND-AUTO 	Knob, 2-position, maintained 1NO-1NC contact Nameplate HAND-AUTO 	Knob, 2-position, maintained 1NO-1NC contact Nameplate HAND-AUTO 

5 Control Units × 1 Column

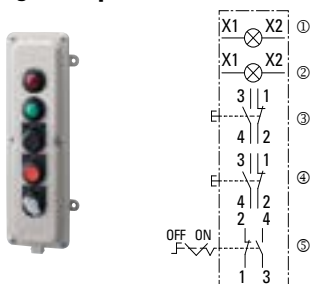
2 pilot lights / 2 pushbuttons / 1 selector switch



	EC2B-5113BN3N□5-U	EC2B-5113BN3N□6-U	EC2B-5113BN3N□3-U
①	120V AC, Illumination color: red	240V AC, Illumination color: red	24V AC/DC, Illumination color: red
②	120V AC, Illumination color: green	240V AC, Illumination color: green	24V AC/DC, Illumination color: green
③	Flush momentary 1NO-1NC contact, Nameplate ON Button color (black, green, red, white)	Flush momentary 1NO-1NC contact, Nameplate ON Button color (black, green, red, white)	Flush momentary 1NO-1NC contact, Nameplate ON Button color (black, green, red, white)
④	Flush momentary 1NO-1NC contact, Nameplate OFF Button color (black, green, red, white)	Flush momentary 1NO-1NC contact, Nameplate OFF Button color (black, green, red, white)	Flush momentary 1NO-1NC contact, Nameplate OFF Button color black, green, red, white)
⑤	Knob, 2-position, Main- tained, 1NO-1NC contact, Name plate HAND-AUTO 	Knob, 2-position, Main- tained, 1NO-1NC contact Name plate HAND-AUTO 	Knob, 2-position, Main- tained, 1NO-1NC contact Name plate HAND-AUTO 

Specify terminal style code in place of □ in part no. C (standard screw terminal), F (finger-safe screw terminal)

Dimensions

Pushbuttons

Shown with finger-safe contacts

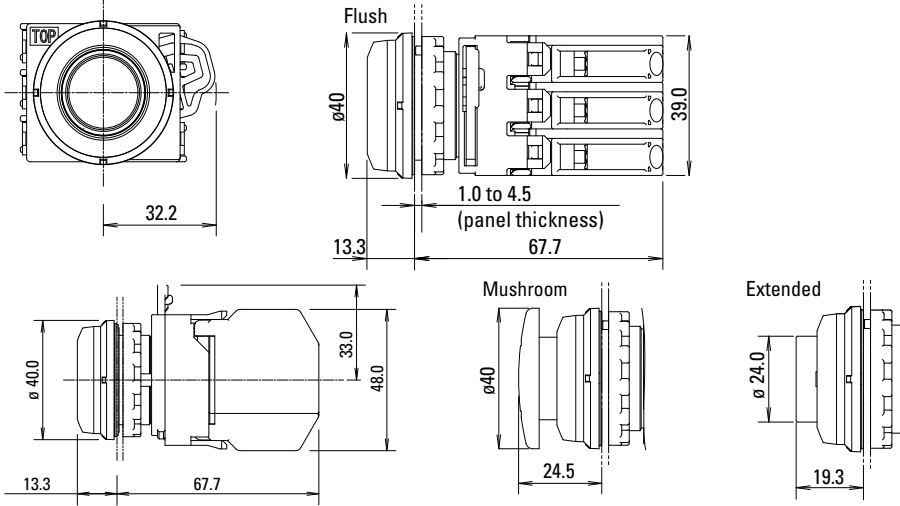

Emergency Stop Switches

Shown with finger-safe contacts

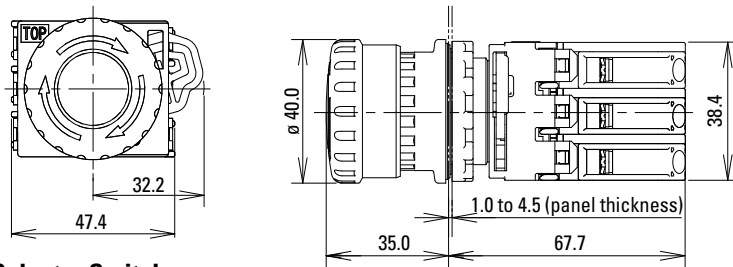

Selector Switches

Shown with finger-safe contacts

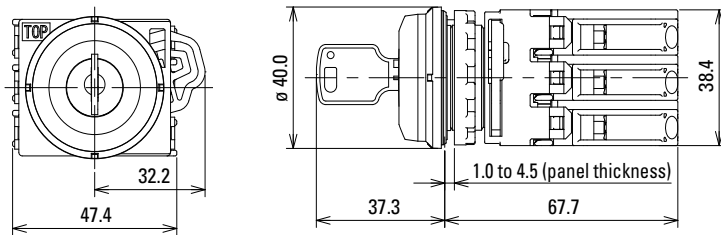

Key Selector Switches

Shown with finger-safe contacts

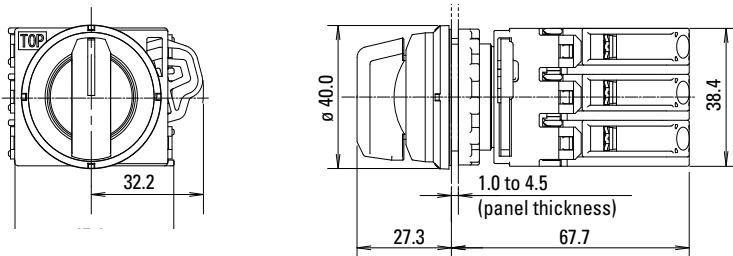

Pilot Lights

Shown with finger-safe contacts

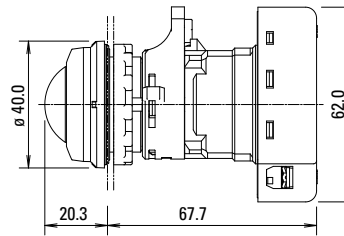
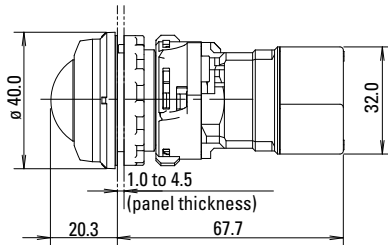
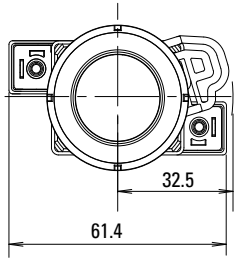

Meters

Shown with finger-safe contacts

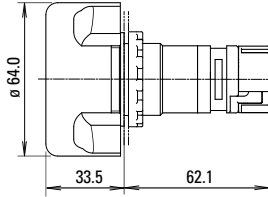
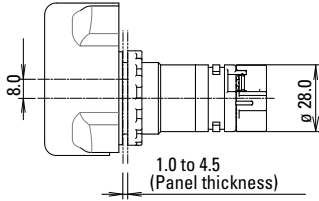
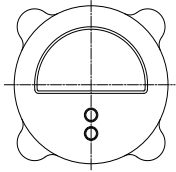

Mounting Hole Dimensions

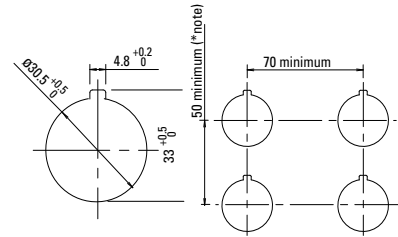

Panel thickness: 1.0 to 4.5 mm.

*Note: The meter can be mounted on the top mounting holes of a standard 50mm mounting centers. The meter can be mounted on any mounting hole with a 70mm or larger mounting center.

1, 2 control units x 1 column

weight: 1.2kg/1.4kg

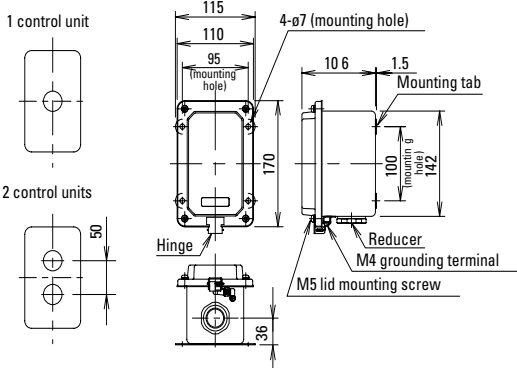

2, 3, 4, 5 control units x 2 columns

weight: 3.8/4.2/4.6/5.0 kg

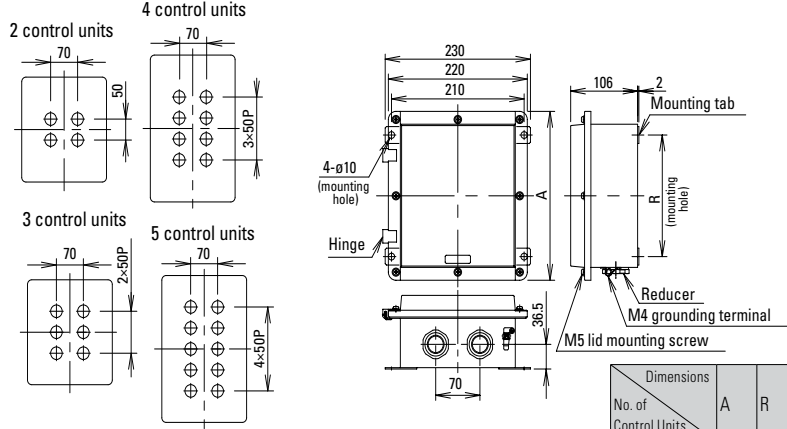

3 control units x 1 column

weight: 1.8kg

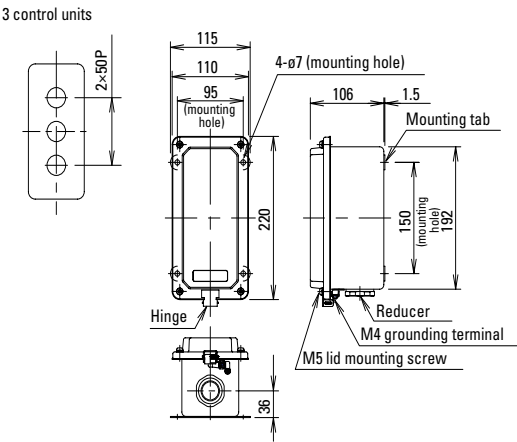

2, 3, 4, 5 control units x 3 columns

weight: 4.8/5.2/6.5/7.1 kg

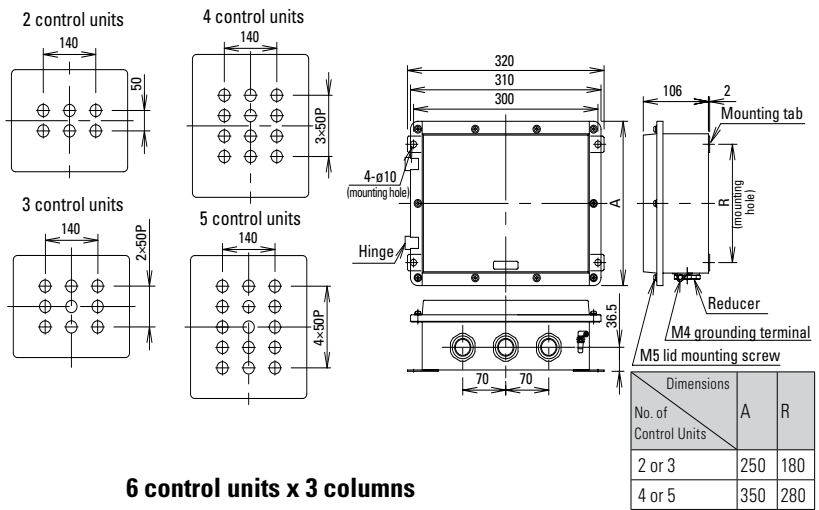

4, 5 control units x 1 column

weight: 2.4kg

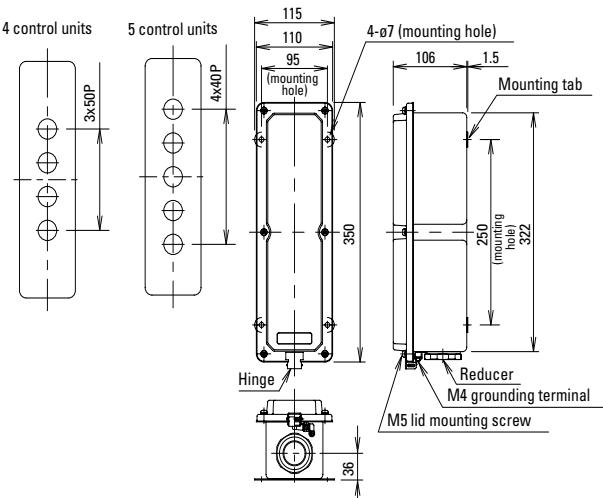

6 control units x 3 columns

weight: 8.1kg

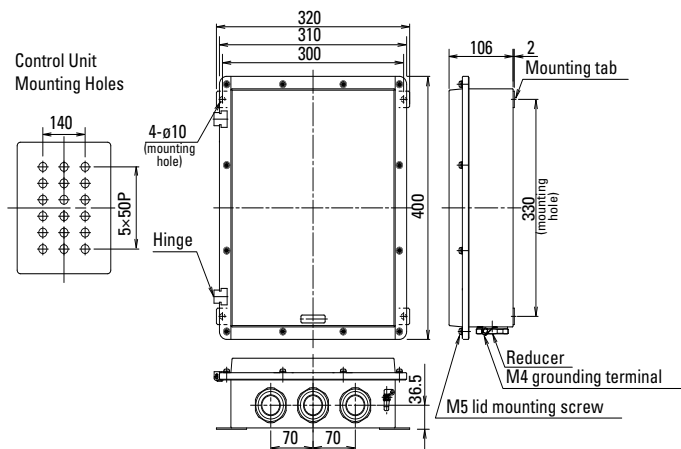

Terminal Blocks

Terminal blocks are not supplied with the standard control boxes (without wiring). When wiring inside the control box is required, specify the wiring circuit. The terminal block type used on the control boxes with wiring depends on the terminal style of the control unit.

C terminal style

exposed screw terminal
ET2A-8PE
polyamide
IECEX TUR 15.0043U,
TÜV 15 ATEX 7799U

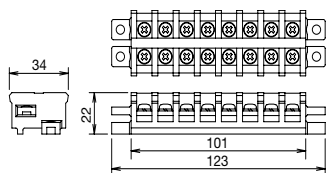

F terminal style

finger-safe spring clamp terminal
IP20 clamp terminal: 264-238 (WAGO)
polyamide
IECEX PTB 04.0003U, PTB 98 ATEX
3129U

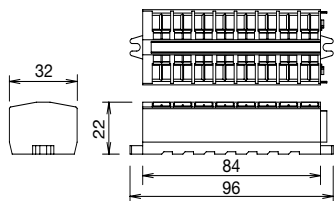

The number of terminal blocks, poles, and the installation direction that can be installed on the control box are as follows:

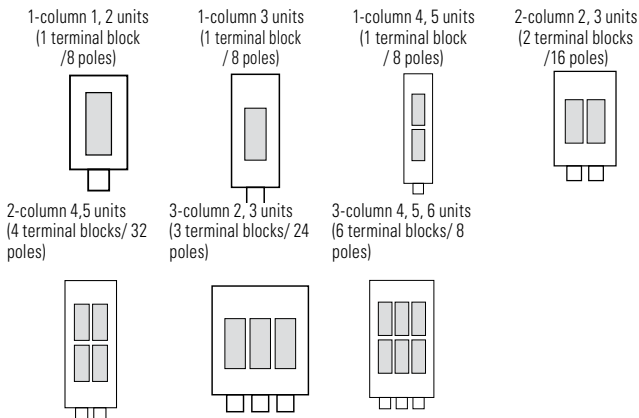

Fittings and Reducers

Reducers installed at the bottom of the control box are as follows: 1 column: 1 reducer, 2 columns: 2 reducers, 3 columns: 3 reducers. Material is nickel-plated brass. Use cable lead-in fittings that are commercially available. See the following table for optional reducers.

Control Box Style	Part No.	Thread Size	Symbol	UL c-UL
1 column (1 to 3 control units) 2, 3 columns (2, 3 control units)	EC9E-H3M16E-UL	M16	M1	○
	EC9E-H3M20E-UL	M20	M2	○
	EC9E-H3M25E-UL	M25	M3	○
	EC9E-H3M32E-UL	M32	M4	○
	EC9E-H3NPT1E-UL	NPT 1/2	N1	○
	EC9E-H3NPT2E-UL	NPT 3/4	N2	●
1, 2, 3 columns (4, 5 control units) 3 columns (6 control units)	EC9E-H3NPT3E-UL	NPT 1	N3	○
	EC9E-H4M25E-UL	M25	M3	○
	EC9E-H4M32E-UL	M32	M4	○
	EC9E-H4M40E-UL	M40	M5	○
	EC9E-H4NPT2E-UL	NPT 3/4	N2	○
	EC9E-H4NPT3E-UL	NPT 1	N3	●
	EC9E-H4NPT4E-UL	NPT 1 1/4	N4	○

●: Standard reducer ○: non-standard reducer

The reducers in the table above are for replacement use only. All EC2B boxes are supplied with a reducer that has been secured to the housing per UL regulations. If it is necessary to replace a reducer, the user should follow appropriate UL standards for securing to EC2B housing.

Accessories



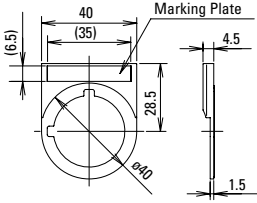

Nameplates

Used for pilot light, pushbutton, selector switch, and key selector switch.







Appearance	Part Number	Dimensions
	EU9Z-NM	

All dimensions in mm

Rubber Boots

Appearance	Description/Usage	Part Number
	For Flush Pushbuttons Not for use with name plate	EU9Z-DB1
	For Flush Pushbuttons For use with name plate	EU9Z-DB1N
	For Extended Pushbuttons Not for use with name plate	EU9Z-DB2
	For Extended Pushbuttons For use with name plate	EU9Z-DB2N

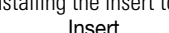
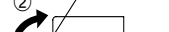
Nameplate Inserts

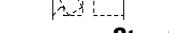
Appearance	Legend	Part Number
	Blank	EU9Z-NP0
	ON	EU9Z-NP1
	OFF	EU9Z-NP2
	START	EU9Z-NP3
	STOP	EU9Z-NP4
	OFF-ON	EU9Z-NP31
	HAND-AUTO	EU9Z-NP35
	HAND-OFF-AUTO	EU9Z-NP53



Material: Aluminum

Installing the insert to the nameplate

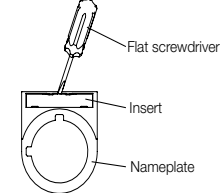
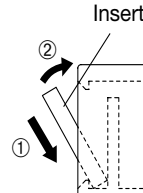
Removing the insert from the nameplate

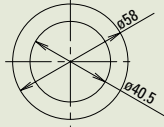

Emergency Stop Switch Nameplate Stickers

Appearance	Legend	Part Number	Dimensions
	Blank	EU9Z-NVS0	
	Emergency Stop	EU9Z-NVS27	

Material: yellow synthetic paper Legend: black

Emergency Stop Switch Padlock Cover

Used with EU2B-YBV emergency stop switch to maintain the switch in the latched status.

Padlock Cover

EU2B-YB2 extended pushbutton: to maintain latched status

EU2B-YB1 flush pushbutton/EU2B-YSK key selector switch: to prevent operation

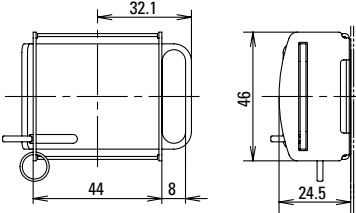
Appearance	Part Number	Dimensions
	EU9Z-PC	

Note: mounted to outside of enclosure with screws, not provided by IDEC
Material: Stainless Steel

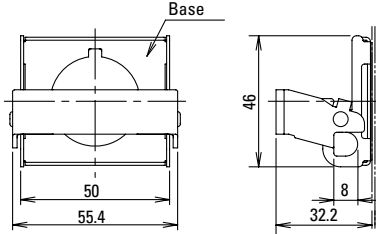
Appearance	Part Number	Dimensions
	EU9Z-PCE	

Coating: yellow Material: Stainless Steel

Mounting Hole Plug

Used to plug unused mounting holes (ø30.5) on the mounting panel.

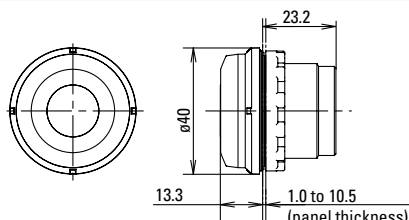
Appearance	Part Number	Dimensions / Usage
	EU9Z-BP	

Lenses

Appearance	Lens Color	Part Number
	Red	EU9Z-LR
	Green	EU9Z-LG
	Amber	EU9Z-LA
	Yellow	EU9Z-LY
	White	EU9Z-LW
	Blue	EU9Z-LS

Material: AS resin (gasket supplied)

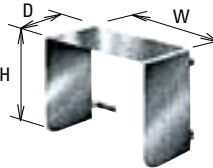

Control Box Shade

Shape	Part No.	Applicable Control Box	Dimensions (mm)		
			H	W	D
	EC9Z-F2A21M	EC2B-11*B EC2B-21*B	180	160	160
	EC9Z-F2A31M	EC2B-31*B	230	160	160
	EC9Z-F2A51	EC2B-41*B	360	160	160
		EC2B-51*B			
	EC9Z-F2A32	EC2B-22*B	260	420	160
		EC2B-32*B			
	EC9Z-F2A52	EC2B-42*B	360	420	160
		EC2B-52*B			
	EC9Z-F2A33	EC2B-23*B	260	510	160
		EC2B-33*B			
	EC9Z-F2A53	EC2B-43*B	360	510	160
		EC2B-53*B			
EC9Z-F2A63	EC2B-63*B	410	510	160	

Material: stainless steel
Thickness: 1mm
Photo: Part No. EC9Z-F2A52

Protects control units from direct sunlight and rain. The surface of the control box shade is uncoated. Can be installed by tightening to the mounting tabs on the control box.

Buttons

Appearance	Style	Part Number	Button Color Code
	Flush	HW1A-B1⓪	Specify a color code in place of ⓪ in the Ordering Number. R : red G : green B : black Y : yellow W : white S : blue
	Extended	HW1A-B2⓪	
	ø40 Mushroom	HW1A-B4⓪	

Material: Polyacetal

Operating Instructions

Installation Area

Do not install the EC2B control box in an environment where more than IP65 protection degree (more than Type 4X in North America) is required.

Use the EC2B control box under ambient temperature of -20 to +50°C. If the control box is exposed to direct sunlight and the surface temperature may rise above 50°C, provide a shade to keep the surface temperature below 50°C.

Installation

Use four M6 bolts for 1-column, four M8 bolts for 2- and 3-column, or other methods with equivalent strength to install the control box. Mounting tab thickness is 1.5mm for 1 column and 2mm for 2 and 3 columns.

If bolts become may loose due to vibration, use spring washers.

If bolt corrosion is anticipated, use anti-corrosion bolts or other countermeasures.

Notes on Emergency Stop Switches

When using the emergency stop switches on safety-related parts of the control system, observe safety standards and regulations of the relevant country or region. Also be sure to perform a risk assessment before operation.

Opening/Closing the Lid

Use a Philips screwdriver to loosen lid mounting screws. While holding the unhinged side, open the lid slowly without exerting excessive force on the hinge.

Before closing the lid, make sure of the following:

No foreign substances are on the packing or joint surfaces.

No displacement of the waterproof packing.

Wires are not caught between the joint surfaces.

Next, close the lid slowly and tighten the screws to a proper torque of 1.6 to 2.4 N·m.

Limitation of the Operating Current

Major heat sources comes from the wiring which is connected to the control box. Therefore, not only the operating current but wiring conditions (size, no. of wires, no. of wire bundles) may cause temperature rise. When wiring, observe the following conditions.

Stranded wire: 1.5 to 2.5 mm² (UL-c-UL certified) / Solid wire: ø1.2 to ø1.6 mm (16 to 14 AWG)

Maximum no. of wires per bundle: 16

Maximum operating current: 10A

When using the control box under an operating environment of 40°C minimum, use a heat resistant cable of 70°C minimum.

Determine the operating current so that the total heat value of 1 wire bundle is below 300 [A²×wires]. Also, when calculating the heat value, take the current fluctuation (10%) into consideration. [calculation example: EC2B-41**B (8 circuit)]

① Apply 10A to 1 circuit, 1A to the remaining 7 circuits:

$$\{(10A \times 1.1)^2 \times 2 \text{ wires}\} + \{(1A \times 1.1)^2 \times 14 \text{ wires}\} \approx 259 \text{ (can be used because } < 300)$$

② Apply 10A to 1 circuit, 2A to the remaining 7 circuits:

$$\{(10A \times 1.1)^2 \times 2 \text{ wires}\} + \{(2A \times 1.1)^2 \times 14 \text{ wires}\} \approx 310 \text{ (cannot be used because } > 300)$$

See the table below for the allowable operating current when applying current evenly to each control box.

Allowable Operating Current

Control Box Part No.	Max. No. of Circuits	Max No. of Wires per Bundle (*1) [wires] ([wires]×[bundle])		Allowable Operating Current (reference) (*2)
		Without terminal-blocks	With terminal blocks	
EC2B-11	3	16 (16×1)	8 (8×1)	7A
EC2B-21	6	16 (16×1)	8 (8×1)	5A
EC2B-31	9	16 (16×1)	8 (8×1)	4A
EC2B-41	12	16 (16×1)	16 (16×1)	3A
EC2B-51	15	16 (16×1)	16 (16×1)	3A
EC2B-22	12	32 (16×2)	16 (8×2)	5A
EC2B-32	18	32 (16×2)	16 (8×2)	4A
EC2B-42	24	32 (16×2)	32 (16×2)	3A
EC2B-52	30	32 (16×2)	32 (16×2)	3A
EC2B-23	18	48 (16×3)	24 (8×3)	5A
EC2B-33	27	48 (16×3)	24 (8×3)	4A
EC2B-43	36	48 (16×3)	48 (16×3)	3A
EC2B-53	45	48 (16×3)	48 (16×3)	3A
EC2B-63	54	48 (16×3)	48 (16×3)	3A

*1: Make sure that the number of wires per bundle is a maximum of 16 by reducing the wiring or by jumper wiring. The maximum number of wires per bundle may need to be further reduced depending on the wire size, lead-in fitting, or conduit size.

*2: The allowable current value (reference) when applying current evenly to all circuits of the maximum number of circuits.

Wiring

Wiring Construction

Observe the laws and regulations in each country concerning wiring construction. Use cable wiring or metal conduit wiring for installation in hazardous locations. If foreign objects or water may enter the box, install a sealing fitting near the cable entry of the box and seal the control box using a compound. Standard type control boxes do not contain a terminal block. Wire the control units directly.

Applicable Wires

Stranded wire: 1.25 to 2.5 mm², solid wire: ø1.2 to ø1.6 mm (AWG16 to 14). Do not connect more than 2 wires to the same terminal.

Applicable crimping terminal

Ring and spade terminals cannot be used for EU2B control units with IP20 finger-safe terminals. Ring and spade terminals cannot be used for IP20 clamp type terminal blocks. When connecting two ferrules to an EU2B control unit, use ferrules without insulating sheath.

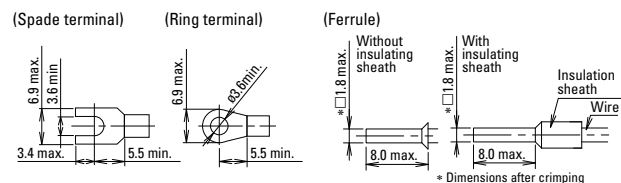

For screw terminal ET2A-8PE For IP20 clamp terminal (WAGO: 264-238)



Recommended crimping terminal (WAGO) Ferrule with insulating sheath: 216-204
 Ferrule without insulating sheath: 216-104 Crimping plier: 206-204

Recommended Tightening Torque

EU2B control units (M3.5) and ET2A-8PE terminal block (M4): 1.0 to 1.3 N·m

Warning

Incorrect wiring may cause fire hazard. Observe the following conditions.

Be sure to install an insulating sheath on the crimping terminal or the crimping terminal with insulation.

When connecting solid wires or stranded wires directly, strip the insulation as mentioned below, and insert the wire all the way in.

EU2B Control units: 8.6 mm maximum
 IP20 crimping terminal: 8 to 9 mm

When using stranded wires, make sure that there are no wire whiskers. Make sure that the spade crimping terminals and ferrules are inserted all the way in.

Use insulated ring terminals for the ET2A-8PE terminal block. Use only applicable crimping terminals and do not directly connect stranded wires or solid wires.

Removing and Installing the Contact Unit / Lamp Unit

To remove the contact unit or the lamp unit from the operator, pull the protruding yellow part of the locking lever outwards as shown in the figure below using a screwdriver, and turn it to the left. The contact unit or lamp unit can be removed.

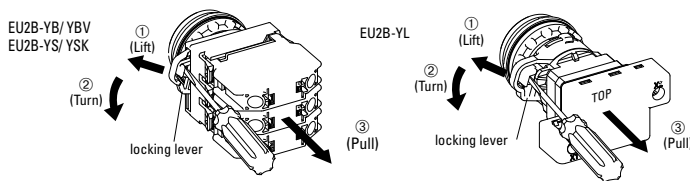

When the contact unit is removed from the emergency stop switch operator, the NO contact closes and the NC contact opens.

Do not turn the locking lever when the contact unit is removed from the operator (the red indicator protruding out, see the figure below) or the switch can be damaged.

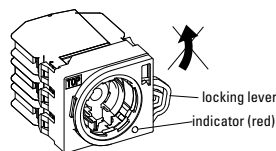

Panel mounting for the operator, lens unit and meter

Remove the locking ring from the operator and check that the rubber gasket is in place. Insert the operator from the panel front into the panel hole. Place the projection on the operator with TOP marking upward and the recess on the mounting panel in the same direction. Meters have no projection.

Tighten the locking ring using ring wrench XN9Z-T1 to a torque of 2.5 Nm. When using a nameplate or padlocking cover, install it between the operator and panel. Make sure that the groove of the nameplate or padlocking cover and the projection on the TOP marking of the operator are in the same direction.

Note: The locking ring for emergency stop switches and meter is metallic. The meter can't mount the nameplate or padlocking cover.

Installing the contact unit and lamp unit

To install the contact unit, place the TOP marking on the operator and the TOP marking on the contact block adapter in the same direction, and then attach the contact unit to the operator. Then turn the locking lever to the right. Follow the same procedure when installing the lamp unit.

When installing the lamp unit, check that the inner lens is not loose.

The contact block adapters for emergency stop switches cannot be used for pushbuttons, selector, or key selector switches.

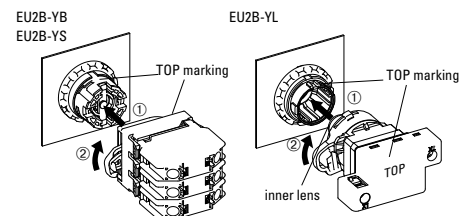
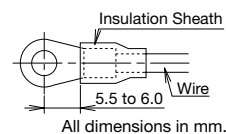
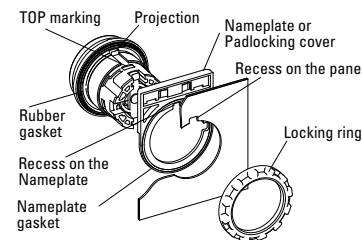

Removing the Contact Block

To remove the contact block, insert a flat screwdriver under the latch of the contact block adaptor and disengage the latch as shown in the figure below.

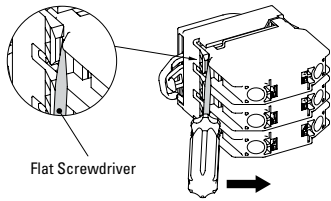

Installing the Contact block

When installing the contact block after maintenance or wiring, make sure that the contact configuration is correct. Installing the contact block in the incorrect position or incomplete installation may cause malfunction of the switch.

Remove the contact block from the operator before installing the contact block to the contact block adaptor. Also make sure that the contact block is correctly installed to the contact block adaptor before attaching the operator. Do not install the contact block adaptor with the operator attached. Otherwise, malfunction may result.

Protective Grounding

Protective grounding must be performed according to the installation environment and rating requirements. Observe laws and regulations set by each country.

Connect the M4 grounding terminal of the EC2B control box to a proper ground (grounding resistance 10Ω maximum). When operating the EC2B control box by connecting to circuits of 300V or below, the grounding resistance must be 100Ω maximum.

When using cables, connect one of the cable cores to the grounding terminal in the enclosure.

If the grounding terminal in the enclosure cannot be used, use the M4 grounding terminal on the outside of the enclosure. Recommended tightening torque: M4: 1.0 to 1.3 Nm, M6: 3.9 to 5.4 Nm. For grounding, use appropriate wires (size, material, insulation) that can tolerate the expected maximum grounding current. Be sure to protect the grounding wire with protection, such as metal conduit, from external damage.

Accessories

Padlock Cover

The following padlocks and hasps can be used.

(Padlock Size)	a	b	c
Flush/extended pushbutton/key selector switch	ø3.5 to 7.0 mm	15 mm min.	70 mm max.
Emergency Stop Switch	ø5.5 to 7.0 mm	—	—

Recommended Hasp

Manufacturer	Part No.
Panduit	PSL-1, PSL-1A, PSL-1.5, PSL-1.5A, PSL-HD1
Master Lock	420, 421

Padlock and hasp are available in various shapes and sizes. Make sure that they do not interfere with the control units. Note: Not supplied by IDEC. Keep the total weight of padlock and hasp under 1500g max, otherwise the switch may malfunction or result in failure. No vibration should be applied when padlock or hasp are installed. When padlock or hasp are disfigured, stop usage immediately.

Ensure that no shock or electric sparks are generated.

When using the plate lock padlock cover with the extended pushbutton, the switch contact may turn on/off when the cover is being installed. Ensure to

provide functional safety measure to prevent unexpected startup. When using the padlock cover on the safety-related part of the control system, observe safety standards and regulations of the relevant country or region. Also be sure to perform risk assessment before operation.

Installing EU9Z-PC Padlock Cover

(Flush/extended pushbutton/key selector switch)

EU9Z-PC can be installed in the following two ways.

Remove the cover in the reverse step of installing the cover. Do not install or remove the cover forcefully, or it will cause failure.

[Installation A]

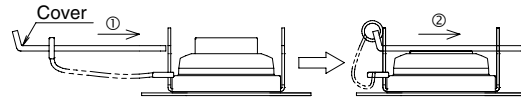

[Installation B]

This method is effective when the neighboring control unit interferes when installing in method A.

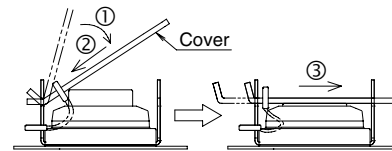

Installing EU9Z-DB Rubber Boots

To install the rubber boot on flush and extended pushbuttons, place the rubber boot on the cap and push the rubber boot holder straight. The notches around the rubber boot must show evenly.

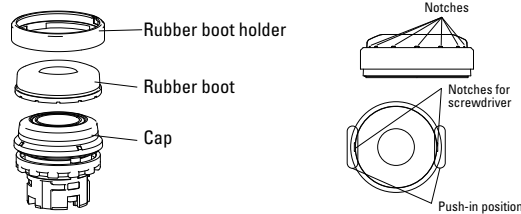

Push the rubber boot holder further around on the two notches on the holder so that the holder fits the button completely.

Make sure that the rubber boot and rubber boot holder are installed straight.

On Nameplate Types, the EU2B and the rubber boot holder must be aligned so that when installed, the anti-rotation projection on the EU2B comes to the center of the groove on the holder.

Make sure that the rubber boot is installed completely, otherwise water droplets might enter the rubber boot, but no water will enter the control box.

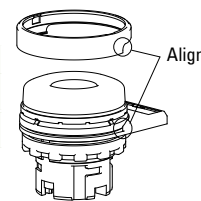

To remove the rubber boot from the flush and extended pushbuttons, gently insert the slotted screwdriver (0.5t x 4w or below) inside a notch on the rubber boot holder and tilt to the direction shown by the arrow ①. To prevent damage, do not apply excessive force to the EU2B when removing the rubber boot.

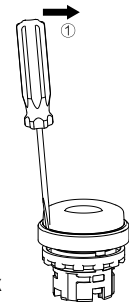

Maintenance and Inspection

EU2B switches should be installed in an appropriate control box.

Maintenance and Inspection Method

Perform daily or periodical maintenance and inspection for items such as damage and temperature rise of the EU2B switches listed in the Maintenance and Inspection table below.

Observe laws and regulations set by each country. Do not open the lid when inspecting the EC2B while it is energized. Never disassemble the control box. Do not use tools that cause sparks during maintenance and inspection. When using measuring devices, use explosion-protected types. When the EC2B needs to be disassembled or assembled for maintenance or repair, contact IDEC.

Maintenance and Inspection

Inspection Items	Inspection Method	Inspections	Measures
Enclosure base	Visual	No rusting No damages	Cleaning Rust-resistant treatment
Tightening bolt, screws	Visual, tactile	No loosening No rusting	Tightening Cleaning
Packings	Visual	No cracks No apparent deformation	Replacement
Connecting parts	Visual, tactile	No loosening of screws No dirt on insulation materials	Tightening Cleaning
Temperature rise	Thermometer, tactile	Surface temperature 80°C max.	Investigate the cause

Disposal

Observe laws and regulations set by each country concerning refuse disposal.

Safety Precautions**EU2B Control Units**

Use EU2B switches that are applicable for use in hazardous areas (potentially explosive atmosphere where explosive gas or vapor may exist), otherwise explosion or fire hazard may result.

EU2B switches can be installed only in zones 1 and 2. Do not use in zone 0.

Turn power off to the EU2B switches before installation, removal, wiring, or maintenance, otherwise explosion, fire hazard, or electric shock may result.

Do not disassemble, repair, or modify, otherwise damage or accident may result.

Do not use damaged EU2B switches, otherwise damage or accident may result.

When connecting external devices, make sure that each cable is connected to the correct terminal, otherwise electric shock, fire hazard, or explosion may result.

Use wires of a proper size to meet voltage and current requirements. Incorrect wiring may cause abnormal temperature rise and lead to fire hazard and explosion.

Connect the grounding terminal to a proper ground, otherwise electric shock, fire hazard, or explosion may result.

Operate the EU2B switches at the rated current and voltage specified in this catalog, otherwise short-circuiting, fire hazard, or explosion may result.

Stop operation immediately if abnormal operation occurs. Otherwise, a secondary accident may occur.

Use explosion-proof electrical equipment that are applicable for use in hazardous areas (potentially explosive atmosphere where explosive gas or vapor may exist), otherwise explosion or fire hazard may result.

EC2B Control Boxes

EC2B control boxes can be installed only in zones 1 and 2. Do not use in zone 0. In North America, the EC2B can be installed in Division 2 areas, but cannot be installed in Division 1 areas.

Turn power off to the EC2B control box before installation, removal, wiring, or maintenance, otherwise explosion, fire hazard, or electric shock may result.

Special skills and knowledge of explosion protection, electric system installation, and relevant laws/regulations are required to transport, install, wire, operate, repair, and inspect the EC2B control box. People without such expertise must not use the EC2B control box, otherwise damage or accident may result.

Do not modify the EC2B, otherwise damage or accident may result.

Do not use a damaged EC2B control box, otherwise damage or accident may result.

When connecting external devices, make sure that each cable is connected to the correct terminal, otherwise electric shock, fire hazard, or explosion may result.

Use wires of a proper size to meet voltage and current requirements. Incorrect wiring may cause abnormal temperature rise and lead to fire hazard and explosion.

Connect the grounding terminal to a proper ground, otherwise electric shock, fire hazard, or explosion may result.

Do not sit on or hang from the EC2B control box, otherwise damage, personal injury, or accident may result.

Do not open the lid of the EC2B control box when it is energized, otherwise electric shock, fire hazard, or explosion may result.

Operate the EC2B control box at the rated current and voltage specified in this catalog, otherwise short-circuiting, fire hazard, or explosion may result.

When measuring the insulation resistance of the EC2B control box, make sure that potentially explosive atmosphere of explosive gas or vapor does not exist in the vicinity, otherwise explosion may result. Also, do not touch the terminals without paying attention, otherwise electric shock will result.

Do not place any obstacles in front of the nameplate.

Do not remove the nameplate.

When opening the lid for wiring, maintenance or inspection, make sure that substances such as dust, concrete powder, or metal powder do not enter inside the box, otherwise contact failure or insulation failure may result.

Do not drop the EC2B control box during transportation.

Be sure to open the carton the right way up, otherwise damage or personal injury may result.

Check that the product is what you have ordered. Using an incorrect model might result in malfunction or accident.

Stop operation immediately if abnormal operation occurs. Otherwise, a secondary accident may occur.

The surface temperature of the EC2B control box may become extremely hot during operation. Before maintenance or inspection of the EC2B, be sure to wear gloves to prevent burning your hand.

CS Series — Heavy Duty Cam Switches

Key features:

- Wide variety of heavy-duty oiltight cam switches
- Operators available up to 12 positions
- Switches made with a double circuit contact block
- Contact blocks rated 600V, 10A
- Ideal for ammeter/voltmeter applications
- Built to order — not available in subcomponents
- UL listed and CSA certified
- Type 12, 13



Contact Ratings

Rated Thermal Current		10A				
AC	Break Current	120V/5A	240V/3A	480V/2A	600V/1A	
	Resistive	Break Current	24V/8A	110V/3A	220V/1A	440V/0.45A
DC	Inductive	Break Current	24V/5A	110V/1.2A	220V/0.45A	440V/0.20A
		Make Current (A)	Rated amperage x 1.1			
Electrical Life		500,000 operations minimum (at full rated load)				
Mechanical Life		5,000,000 (at no load)				

CS Series

Series	Style	Operator		Maximum Contacts To Be Mounted	Handle Styles
		Cam Angle	Position		
ACSNO		30°	Up to 12	1 to 10 decks; Up to 20 contacts	YB, SB, PB, FB
		45°	Up to 8		
		60°	Up to 6		
		90°	Up to 4		
ACSNK		30°	Up to 12	1 to 10 decks; Up to 20 contacts	HB or standard key
		45°	Up to 8		
		60°	Up to 6		
		90°	Up to 4		
UCSQO		30°	Up to 12	1 to 10 decks; Up to 20 contacts	YB, SB, PB, FB
		45°	Up to 8		
		60°	Up to 6		
		90°	Up to 4		
UCSQM		45° Spring return	Only 3	1 to 3 decks; Up to 6 contacts	YB, SB, PB, FB

1. Do not use spring return (SR) for more than six contacts.
2. Two identical keys come with ACSNK unit. Specify "H" for handle key option.

Selector Switches (Assembled)

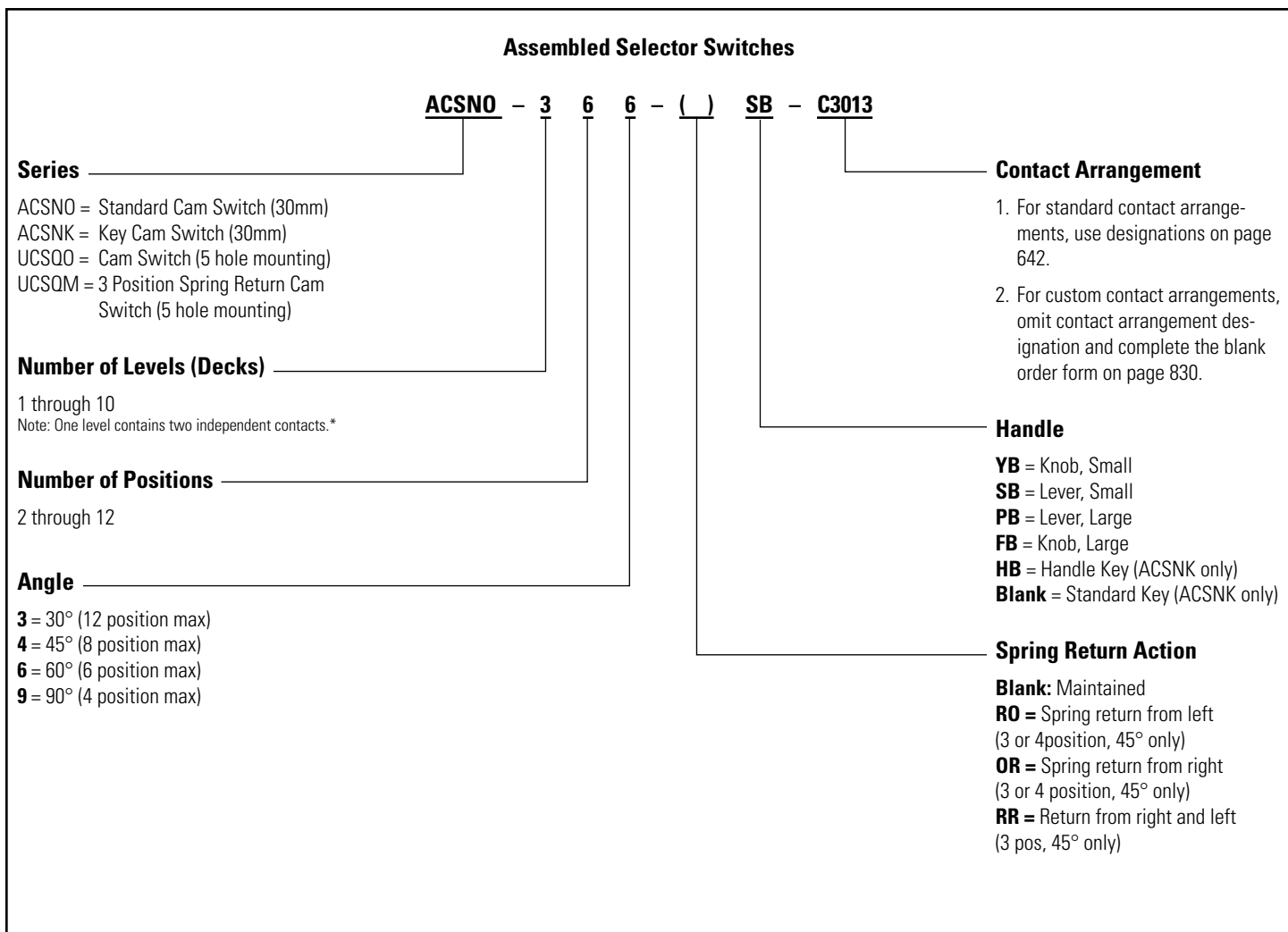

- 1. *Contact blocks may contain two independent contacts, (a four position switch with four independent contacts only requires two contact blocks).
- 2. *Caution: switches with 180° or more of rotation may require separate blocks for each contact due to cam overlapping.
- 3. Key retainable in every 45° position (45, 90, 180, 225, 270, 315, 360).

Contact Arrangements

Standard Arrangements

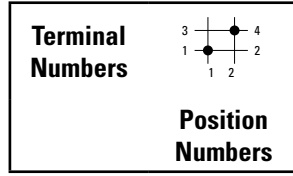

C-1001



C-1002



C-1014



C-1005

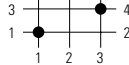

C-1008



C-2001

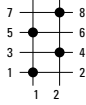

C-2002

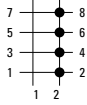

C-2006

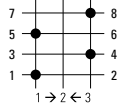

C-2004

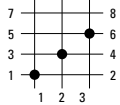

C-2008

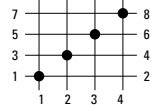

C-2009

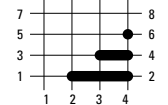

C-2027

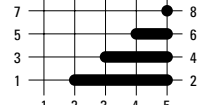

C-3001

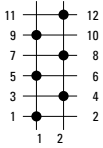

C-3002

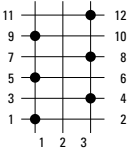

C-3005

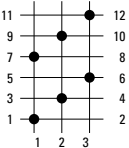

C-3013

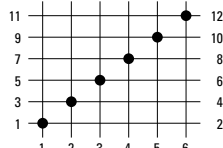

C-3016

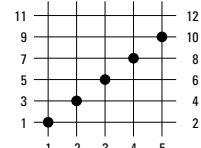

C-4001

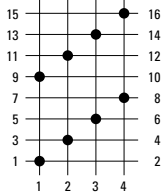

C-4002

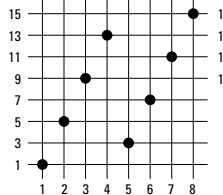

C-5001

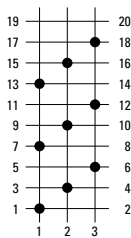

C-6001

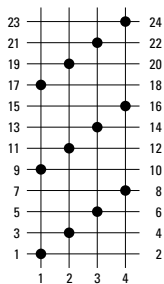

C-6002

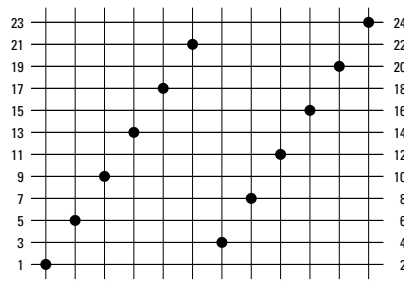

Contact Arrangements continued

Ammeter Switching

C-1012

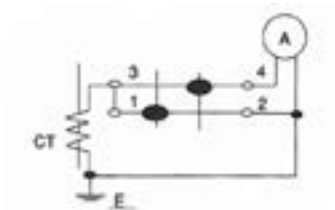

C-4007

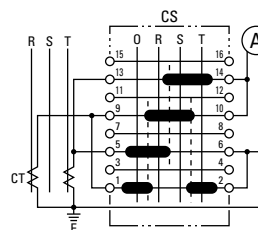

C-4003

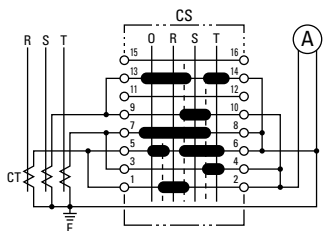

C-6003

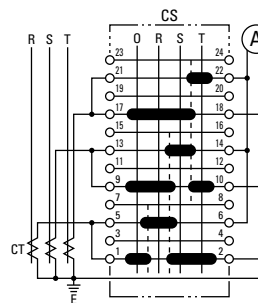

Voltmeter Switching

C-2022

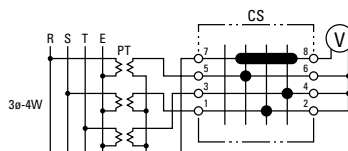

C-3008

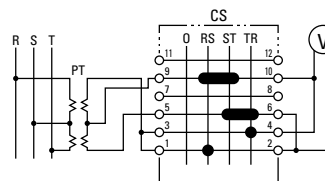

C-3009

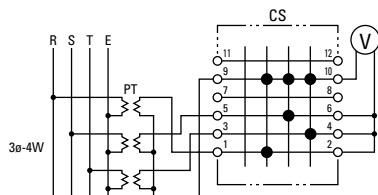

C-3007

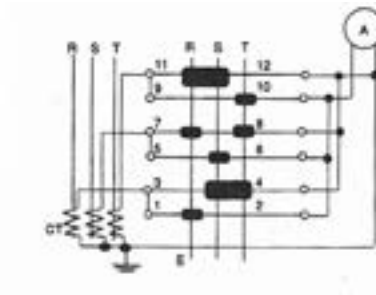

Order Form (Custom Contact Arrangement)

Series ● **Handle** ● **ACSNO, UCSQO, UCSQM:**
 ACSNO
 ACSNK
 UCSQO
 UCSQM

***Number of Decks** ● Specify Qty = 1, 2, 3, 4, 5, 6, 7, 8, 9, or 10

Number of Positions ●

Unit	Angle	Positions
ACSNO	30° only	9, 10, 11, 12
ACSNK*	30° or 45° only	7 or 8
UCSQO	30°, 45° or 60°	5 or 6
	30°, 45°, 60°, 90°	2, 3, or 4
UCSQM	45° only	3 only

Angle ●

3 = 30°
 4 = 45°
 6 = 60°
 9 = 90°

Spring Return
 Blank = Maintained
RO = Spring return from left (3 or 4 position, 45°)
OR = Spring return from right (3 or 4 position, 45°)
RR = Return from right and left (3 position, 45°)

UCSQM is available in spring-return version only.

ACSNO, UCSQO, UCSQM:
YB = Knob, Small
SB = Lever, Small
PB = Lever, Large
FB = Knob, Large

ACSNK:
HB = Handle Key (option)
Blank = Standard Key

 For handle styles, see page 831.

 * ACSNK keys only remove at 45°.

Contact Arrangement Table

Cams	Terminal Numbers	Position											
		1	2	3	4	5	6	7	8	9	10	11	12
Deck 1	1 and 2												
	3 and 4												
Deck 2	5 and 6												
	7 and 8												
Deck 3	9 and 10												
	11 and 12												
Deck 4	13 and 14												
	15 and 16												
Deck 5	17 and 18												
	19 and 20												
Deck 6	21 and 22												
	23 and 24												
Deck 7	25 and 26												
	27 and 28												
Deck 8	29 and 30												
	31 and 32												
Deck 9	33 and 34												
	35 and 36												
Deck 10	37 and 38												
	39 and 40												

 To specify non-standard arrangements (designation not on preceding pages), fill in this table using the following symbols.
X = Closed contact (break before make) **O** = Open contact **X-X** = Overlapping contact (remain on when switch is moved between two positions)

Specifying Nameplate (Optional)

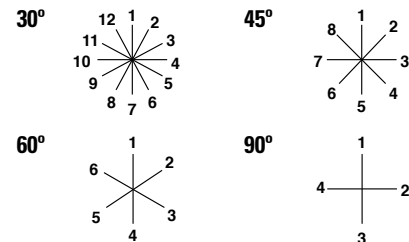

Specifying Legends

Position

1 _____

2 _____

3 _____

4 _____

5 _____

6 _____



If no engraving information is provided, a blank nameplate will be supplied.

1 _____

2 _____

3 _____

4 _____

5 _____

6 _____

Accessories — CS Series

Replacement Handles



					
Part Number	CSH-YB	CSH-SB	CSH-PB	CSH-FB	CSH-H2B
Dimensions	0.79"D x 1.61"H	0.79"D x 1.97"H	1.58"D x 1.97"H	1.58"D x Ø 1.97"	0.95"D x 2.28"H
Applicable Models	ACSNO, UCSQO, UCSQM				ACSNK

Replacement Nameplates

Size & Shape □ 2.52" (64mm) Black Aluminum			
	Part Number	CQ	CQM
Applicable Models	UCSQO	UCSQM	ACSNO, ACSNK

- 1. Extra cost for engraving, 3/16" min. letter height, Legends maximum ten characters.
- 2. Blank nameplates are supplied with all cam switches (they need not be ordered separately).

Wiring Clips

Part Number	Contact Block Jumpers
CJ-1 	Between decks
CJ-2 	Same deck

Replacement Keys

Part Number	Description
K301 	Pair of keys (#301)

Dimensions/Terminal Arrangements/Mounting Holes

ACSNO

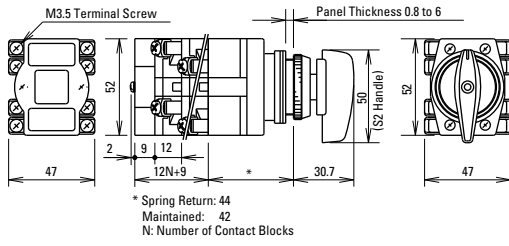

Terminal Arrangement

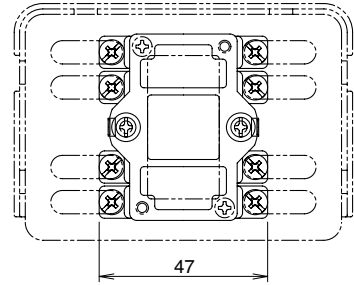

ACS NK

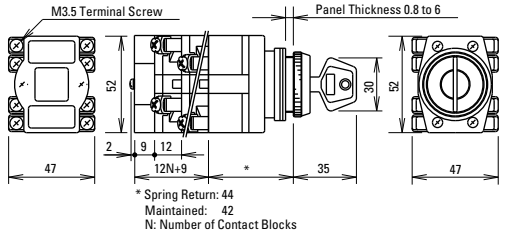

Mounting Holes

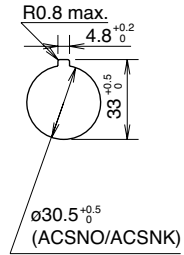

UCSQO

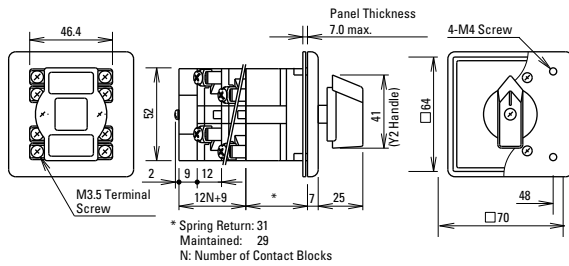

UCSQO
UCSQM

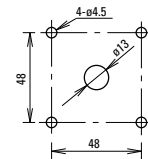

UCSQM

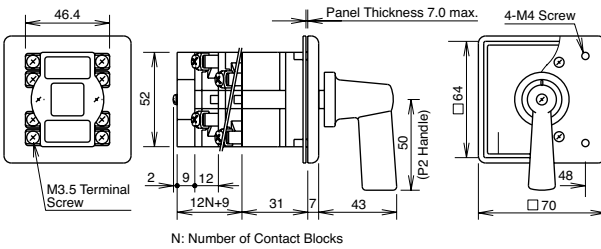

ARN Series – Mono-Lever Switches

Key features:

- Mono-Lever Switches Ø 1-13/64" (30mm)
- Contact Blocks Rated for 600V, 10A
- Available in 2-, 3-, and 4-positions.
- Maintained and spring-return modes available.
- Models available with interlock mechanism to prevent inadvertent actuation.



UL Listed
File No. E68961



CSA Certified
File No. LR48366

Specifications

Operating Temperature		-25° to 50°C (without freezing)
Insulation Resistance		100MΩ
Contact Rating	Rated Voltage: Current	110VDC: 3A
		24V AC/DC: 10A
		120VAC: 10A
		240VAC: 6A
480VAC: 2A		
600VAC: 1A		
Insulation Voltage		600V AC/DC
Rated Thermal Current		10A
Electrical Life		Over 500,000 operations

Part Numbering Guide (Assembled)

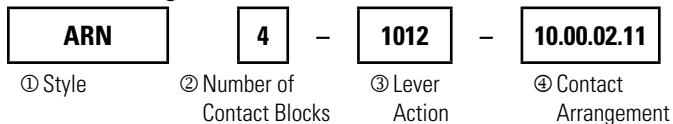

	Description	Code	Remarks
① Style	Standard Lever	ARN	
	Short Lever	ARNS	Interlocking lever prevents inadvertent operation.
	Interlocking Lever	ARNL	
② No. of Contact Blocks	—	1	Each contact block contains two independent contacts.
		2	
		3	
		4	
③ Lever Action	Blocked	0	Specify in this order: Up.Right.Down.Left
	Maintained	1	
	Spring Return	2	
④ Contact Arrangement	No contacts	00	Specify the number of contacts to be activated in all active (non-blocked) positions: Up.Right.Down.Left For blocked positions use code: 00
	1 NO contact	10	
	1 NC contact	01	
	1 NO and 1 NC contact	11	
	2 NO contacts	20	
	2 NC contacts	02	

Switches & Pilot Devices

Signaling Lights

Relays & Sockets

Timers

Contactors

Terminal Blocks

Circuit Breakers

Mono-Lever Switches (Sub-Assembled)



Standard Mono-Lever Operators

Style	Lever Operation Mode	Part Number
Standard Lever	2-Position manual return 3-Position manual return 4-Position manual return	ARNO-1010-B ARNO-1110-B ARNO-1111-B
	2-Position spring return 3-Position spring return 4-Position spring return	ARNO-2020-B ARNO-2220-B ARNO-2222-B
Short Lever	2-Position manual return 3-Position manual return 4-Position manual return	ARNSO-1010-B ARNSO-1110-B ARNSO-1111-B
	2-Position spring return 3-Position spring return 4-Position spring return	ARNSO-2020-B ARNSO-2220-B ARNSO-2222-B
Interlocking Lever	2-Position manual return 3-Position manual return 4-Position manual return	ARNLO-1010-B ARNLO-1110-B ARNLO-1111-B
	2-Position spring return 3-Position spring return 4-Position spring return	ARNLO-2020-B ARNLO-2220-B ARNLO-2222-B

Contact Blocks

Style	Contact Arrangement	Part Number
	2NO contacts	BR-1E
	1NO & 1NC contact	BR-2E
	2NC contacts	BR-3E
	1NO early make contact	BR-1EM



To calculate the number of contact blocks required, add the number of NO and NC contacts on each pair of adjoining positions (up + right, right + down, down + left, and left + up). The largest of the four sums is the number of contact blocks required. Up to four contact blocks can be mounted.

Replacement Parts

Style	Part Number	
Bellows	ARNO, ARNSO (standard & short lever)	ARN-BL
	ARNLO (Interlocking)	ARNL-BL (comes in 2 pieces)
Knob (ball)	All Models Knob (ball)	ARNB-B

Dimensions – ARN Series

ARNO

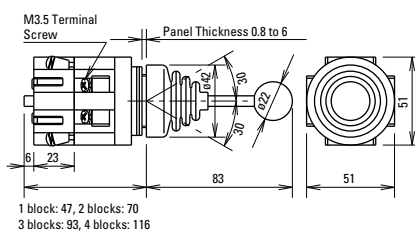

ARNSO

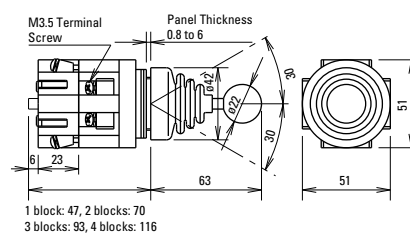

ARNLO

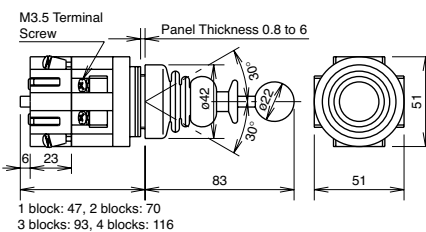

**ARNO
ARNSO
ARNLO**

