













Think Automation and beyond...







Emergency Stop Switches



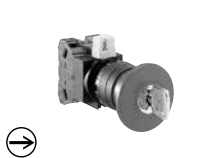





IDEC CORPORATION

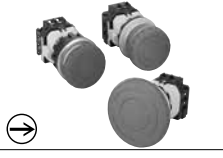





Emergency Stop Switches (Selection Guide)



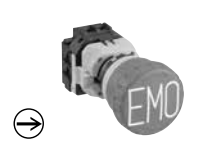





| Series | Emergency Stop Switch | | | | |
|----------------------|---|---|---|--|---|
| Name | ø16mm X6 Series Pushlock Pull / Turn Reset (Unibody) | ø16mm XA Series Pushlock Pull / Turn Reset (Unibody) | ø16mm XA Series Pushlock Pull / Turn Reset (with Removable Contact Block) | ø22mm XW Series Pushlock Pull / Turn Reset | ø22mm HW Series Pushlock Turn Reset (Unibody) (Plastic/Flush Bezel) |
| Shape |  |  |  |  |  |
| Safety Category | 4 | 4 | 4 | 4 | 4 |
| Applicable Standards | EN60947-5-5 UL508 CSA C22.2 No.14 GB14048.5 | EN60947-5-5 UL508 CSA C22.2 No.14 GB14048.5 | EN60947-5-5 UL508 UL991 NFPA79 CSA C22.2 No.14 GB14048.5 | EN60947-5-5 UL508 UL991 NFPA79 CSA C22.2 No.14 GB14048.5 | EN60947-5-5 UL508 CSA C22.2 No.14 GB14048.5 |
| Mark |  |  |  |  |  |
| Page | 8 | 13 | 15 | 21 | 32 |

| Series | Emergency Stop Switch | | | |
|----------------------|---|---|---|--|
| Name | ø22mm HW Series Pushlock Turn Reset (with Removable Contact Block) | ø22mm HW Series Pushlock Key Reset | ø22mm HW Series Push-Pull | ø22mm YW Series Pushlock Pull / Turn Reset |
| Shape |  |  |  |  |
| Safety Category | 4 | 4 | 4 | 4 |
| Applicable Standards | EN60947-5-5 UL508 CSA C22.2 No.14 GB14048.5 | EN60947-5-5 UL508 CSA C22.2 No.14 GB14048.5 | EN60947-5-5 UL508 CSA C22.2 No.14 GB14048.5 | EN60947-5-5 UL508 CSA C22.2 No.14 GB14048.5 |
| Mark |  |  |  |  |
| Page | 34 | 35 | 35 | 40 |

| Series | Emergency Stop Switch | | |
|----------------------|---|---|---|
| Name | ø30mm XN Series Pushlock Pull / Turn Reset (Plastic/Flush Bezel) | ø30mm XN Series Pushlock Turn Reset (Padlockable) | ø30mm HN Series Pushlock Turn Reset (Unibody) |
| Shape |  |  |  |
| Safety Category | 4 | 4 | 4 |
| Applicable Standards | EN60947-5-5 UL508 UL991 NFPA79 CSA C22.2 No.14 GB14048.5 | EN60947-5-5 UL508 UL991 NFPA79 CSA C22.2 No.14 GB14048.5 | EN60947-5-5 UL508 CSA C22.2 No.14 GB14048.5 |
| Mark |  |  |  |
| Page | 48 | 50 | 55 |

Emergency Stop Switches (Selection Guide)

| Series | SEMI Emergency Off (EMO) Switch | | | |
|----------------------|---|---|---|---|
| Name | ø16mm XA Series EMO Switch Pushlock Pull / Turn Reset | ø22mm XW Series EMO Switch Pushlock Pull / Turn Reset | ø22 HW Series EMO Switch Pushlock Turn Reset | Switch Guard for ø16mm XA Series ø22mm HW/XW Series |
| Shape |  |  |  |  |
| Safety Category | 4 | 4 | 4 | — |
| Applicable Standards | EN60947-5-5 UL508 CSA C22.2 No.14 GB14048.5 | EN60947-5-5 UL508 CSA C22.2 No.14 GB14048.5 | EN60947-5-5 UL508 CSA C22.2 No.14 GB14048.5 | SEMI S2 0706 |
| Mark |  |  |  | — |
| Page | 58 | 58 | 58 | 60 |

| Series | Stop Switch | | | | |
|----------------------|---|---|---|---|--|
| Name | ø16mm XA Series Pushlock Pull / Turn Reset (with Removable Contact Block) | ø16mm XA Series Pushlock Pull / Turn Reset (Unibody) | ø22 XW Series Pushlock Pull / Turn Reset | ø22 HW Series Pushlock Turn Reset Pushlock Pull | White Switch Guard for ø22mm HW/XW Series |
| Shape |  |  |  |  |  |
| Safety Category | — | | | | |
| Applicable Standards | EN60947-5-1 UL508 CSA C22.2 No.14 GB14048.5 | EN60947-5-1 UL508 CSA C22.2 No.14 GB14048.5 | EN60947-5-1 UL508 CSA C22.2 No.14 GB14048.5 | UL508 CSA C22.2 No.14 EN60947-5-5 GB14048.5 | — |
| Mark |  |  |  |  | — |
| Page | 62 | 62 | 63 | 63 | 64 |

Emergency Stop Switches Selection Diagram

ISO / IEC Standards and Emergency Stop Switches

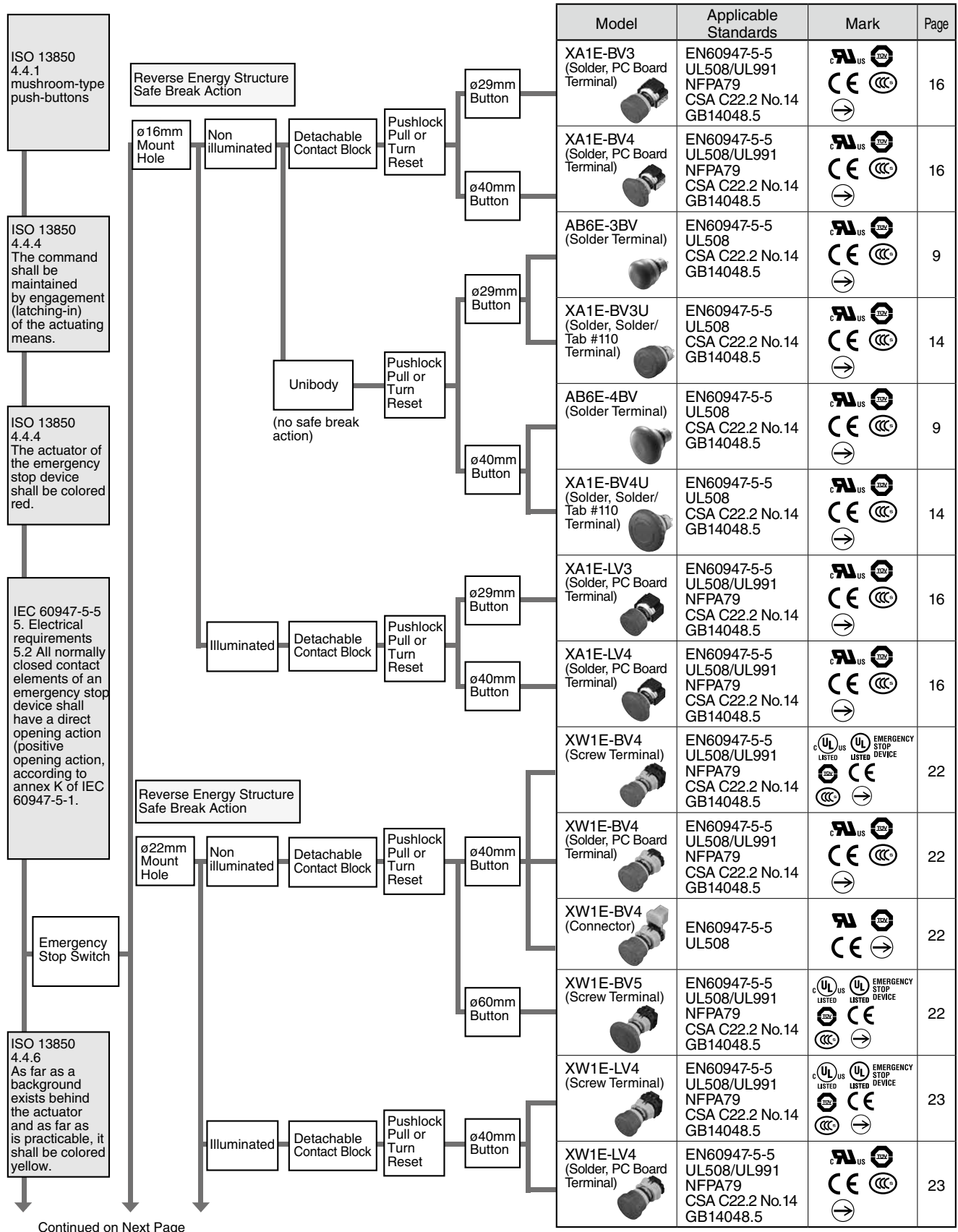

Emergency Stop Switches Selection Diagram

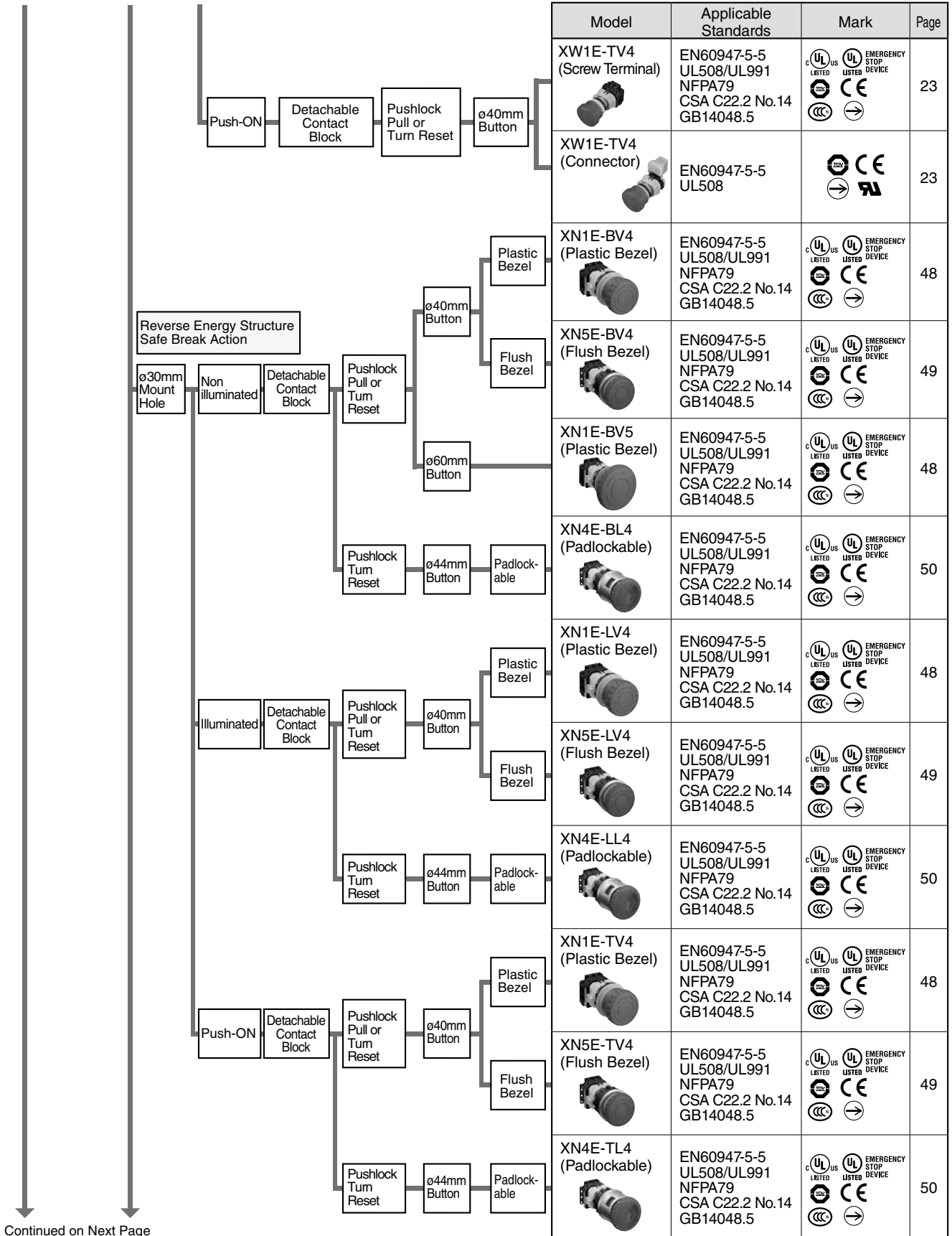

Emergency Stop Switches Selection Diagram

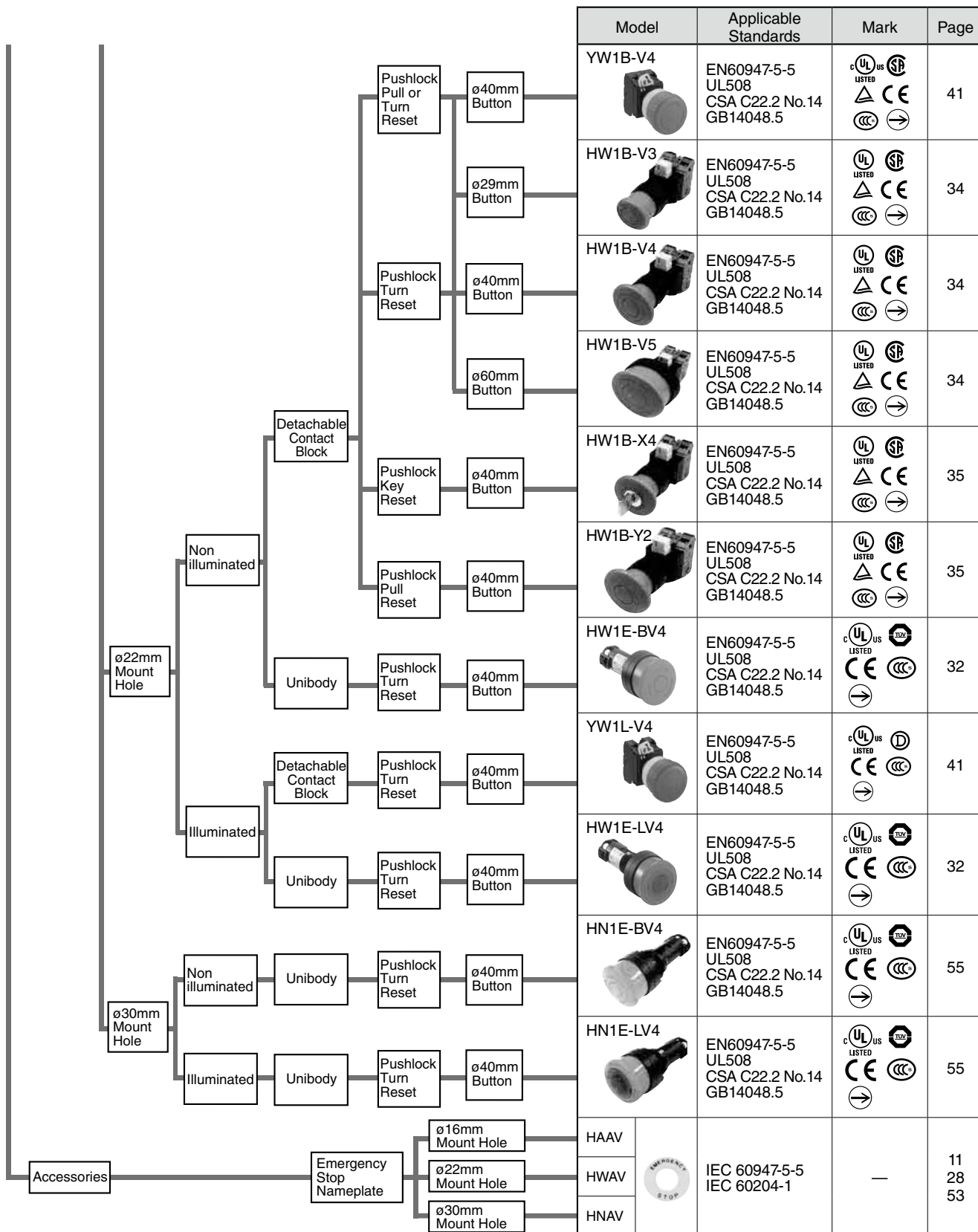

Switch and Background Color Selection Chart (IEC/SEMI/SEMATECH)

Emergency Stop
IEC 60947-5-5
IEC 60204-1
ISO 13850

- Red colored
- Mushroom
- Yellow background
- Shall be positioned for easy access

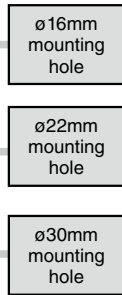
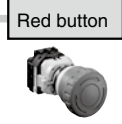

| Switch | Applicable Nameplate (Note 1) | Applicable Switch Guard |
|--|--|-------------------------|
| XA1E HA1E HA1B-V | HA AV-0, HA AV-27 HA AV4-0 HA AV4-27 | N/A |
| XW1E HW1E HW1B-V, HW1B-X HW1B-Y | HW AV-0-Y, HW AV-27-Y HW AV5-0 HW AV5-27 HW AV5F-27 | N/A |
| XN1E XN4E XN5E HN1E | HN AV-0 HN AV-27 | N/A |

Emergency Off (EMO)
SEMATECH Application Guide for SEMI S2-93

Red and mushroom shaped button

- Yellow background
- EMO or Emergency Off labeled

When installing a guard

- Guard diameter ø75mm minimum
- Button recessed from the guard no more than 3mm

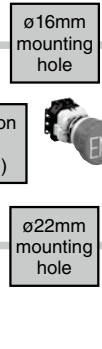
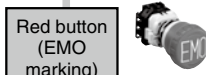

| Switch | Applicable Nameplate (Note 1) / EMO label | | Applicable Switch Guard | |
|---|---|---|---|---|
| | EMO | SEMI | SEMI | SEMATECH |
| XA1E-BV4**RH-EMO | HA AV4-0 | XA9Z-KG1 (Note 2) | — | — |
| XW1E-BV4**RH-EMO HW1B-V4**R-EMO | HW AV-0-Y | HW9Z-KG1 (Note 2) HW9Z-KG2 (Note 2) HW9Z-KG3 (Note 2) HW9Z-KG4 (Note 2) HW9Z-KG5 | HW9Z-KG2 (Note 2) HW9Z-KG4 (Note 2) HW9Z-KG5 | HW9Z-KG2 (Note 2) HW9Z-KG4 (Note 2) HW9Z-KG5 |
| XW1E-BV4**RH-EMO HW1B-V4**R-EMO | HW AV-0-Y | HW9Z-KG5-W | HW9Z-KG5-W | HW9Z-KG5-W |
| XA1E HA1E HA1B-V | HA AV-0, HA AV4-0 in combination with HW9Z-EMO-NPP | XA9Z-KG1 (Note 2) | — | — |
| XW1E HW1E HW1B-V (Note 4) HW1B-X HW1B-Y | HW AV-74-Y, HW AV-0-Y in combination with HW9Z-EMO-NPP | HW9Z-KG1 (Note 2) HW9Z-KG2 (Note 2) HW9Z-KG3 (Note 2) HW9Z-KG4 (Note 2) HW9Z-KG5 (Note 3) | HW9Z-KG1 (Note 2) HW9Z-KG2 (Note 2) HW9Z-KG3 (Note 2) HW9Z-KG4 (Note 2) HW9Z-KG5 (Note 3) | HW9Z-KG2 (Note 2) HW9Z-KG4 (Note 2) HW9Z-KG5 (Note 3) |
| XW1E HW1E HW1B-V (Note 4) HW1B-X HW1B-Y | HW AV-74-Y, HW AV-0-Y in combination with HW9Z-EMO-NPP | HW9Z-KG5-W (Note 3) | HW9Z-KG5-W (Note 3) | HW9Z-KG5-W (Note 3) |
| XN1E XN4E XN5E HN1E | HN AV-0 in combination with HW9Z-EMO-NPP | — | — | — |

Emergency Off (EMO)
SEMI S2-0706

- Red and mushroom shaped button
- Yellow background
- EMO or Emergency Off labeled

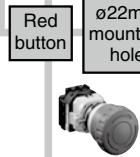

Local/Partial Shut Down
SEMI S26-0308

- Should not use the combination of red button with yellow background
- Should not be labeled as "EMO" or "Emergency Off," or the equivalent.

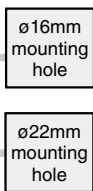

| Switch | Applicable Nameplate | Applicable Switch Guard |
|---|-------------------------|--|
| XA1E-BV***Y HA1E-V2S*Y | HA AV-0-W HA AV4-0-W | — |
| XW1E-BV4**Y HW1B-V***Y HW1B-V2**Y | HW AV-0-W HW AV5-0-W | HW9Z-KG4-W (Note 2) HW9Z-KG5-W (Note 3) |

Note 1: Marking plate legend
-0 (blank), -27 (EMERGENCY STOP), -74 (EMERGENCY OFF)

Note 2: Cannot be used with a nameplate.

Note 3: Cannot be used with HWAV5-*

Note 4: HW1B-V5 switch cannot be used with a switch guard.

Note: Stop switch (yellow button) should not be labeled as "EMS" or "Emergency Stop."

ø16 X6 Series Emergency Stop Switches (Unibody)

Third-generation emergency stop switch with Reverse Energy Structure

Smallest in its class

- Two button sizes—ø30mm and ø40mm
- Two button colors—red for emergency stop switch and yellow for stop switch
- Two ways of resetting —pulling and turning.
- UL, c-UL recognized, EN compliant.
- Safety lock mechanism (IEC 60947-5-5; 6.2)
- Direct opening action (IEC 60947-5-5; 5.2, IEC 60947-5-1, Annex K)
- Degree of protection: IP65 (IEC60529)



Standards

| Applicable Standards | Mark | File No. or Organization |
|--------------------------------------|------|--|
| UL508 CSA C22.2 No.14 | | UL/c-UL Recognition File No.E68961 |
| EN60947-5-1 EN60947-5-5 (note) | | TÜV SÜD |
| | | EU low voltage directive |
| GB14048.5 | | CCC No. 2012010305525957 (Stop switch: CCC No. 2012010305525958) |

- Stop switch (yellow button) is EN60947-5-1.

Contact Ratings

| Rated Insulation Voltage (Ui) | | 250V | | | | |
|--------------------------------|---------------|------------------------|------------------------|-------|------|-------|
| Rated Thermal Current (Ith) | | 5A | | | | |
| Rated Operating Voltage (Ue) | | 30V | 125V | 250V | | |
| Rated Operating Current (Note) | Main Contacts | AC 50/60 Hz | Resistive Load (AC-12) | – | 5A | 3A |
| | | | Inductive Load (AC-15) | – | 1.5A | 0.75A |
| | DC | Resistive Load (DC-12) | 2A | 0.4A | 0.2A | |
| | | Inductive Load (DC-13) | 1A | 0.22A | 0.1A | |

- Minimum applicable load: 5V AC/DC, 1 mA (reference value) (May vary depending on the operating conditions and load)
- Operational current represents the classification by making and breaking currents (IEC 60947-5-1).

Note:

TÜV/CCC rating: AC-15 0.75A/250V, DC-13 1A/30V

UL rating: Standard Duty AC 0.75A/250V
Standard Duty DC 1A/30V

Specifications

| | |
|--|--|
| Applicable Standards | IEC 60947-5-1, EN 60947-5-1 IEC 60947-5-5 (Note), EN 60947-5-5 (Note) JIS C8201-5-1, JIS C8201-5-5, UL508, CSA C22.2 No.14, GB14048.5 |
| Operating Temperature | –25 to +60°C (no freezing) |
| Storage Temperature | –45 to +80°C (no freezing) |
| Operating Humidity | 45 to 85% RH (no condensation) |
| Operating Force | Push to lock: 10.5N Pull to reset: 8.8N Turn to reset: 0.17 N·m |
| Minimum Force Required for Direct Opening Action | 40N |
| Minimum Operator Stroke Required for Direct Opening Action | 4.5 mm |
| Maximum Operator Stroke | 4.5 mm |
| Contact Resistance | 50 mΩ maximum (initial value) |
| Insulation Resistance | 100 MΩ minimum (500V DC megger) |
| Overvoltage Category | II |
| Impulse Withstand Voltage | 2.5 kV |
| Pollution Degree | 3 |
| Operation Frequency | 900 operations/hour |
| Shock Resistance | Operation extremes: 150 m/s ² Damage limits: 1000 m/s ² |
| Vibration Resistance | Operation extremes: 10 to 500 Hz amplitude 0.35 mm, acceleration 50 m/s ² Damage limits: 10 to 500 Hz, amplitude 0.35 mm, acceleration 50 m/s ² |
| Mechanical Life | 100,000 operations minimum |
| Electrical Life | 100,000 operations minimum |
| Degree of Protection | IP65 (IEC 60529) |
| Short-circuit Protection | 250V/10A fuse (Type aM IEC 60269-1/IEC 60269-2) |
| Conditional Short-circuit Current | 1000A |
| Terminal Style | Solder terminal |
| Recommended Tightening Torque for Locking Ring | 0.88 N·m |
| Applicable Wire Size | 1.25 mm ² maximum |
| Terminal Soldering Condition | 310 to 350°C, within 3 seconds |
| Weight (approx.) | ø30mm button: 13g ø40mm button: 16g |





Note: Except for stop switch (yellow button)

X6 Series Emergency Stop Switches (Unibody) ø16

Unmarked

Pushlock Pull/Turn Reset Switch (Solder Terminal)

Package quantity: 1





| Shape | Main Contact (NC) | Part No. |
|--|-------------------|----------------------|
| ø30mm Mushroom   | 1NC | AB6E-3BV01PRH |
| | 2NC | AB6E-3BV02PRH |
| ø40mm Mushroom   | 1NC | AB6E-4BV01PRH |
| | 2NC | AB6E-4BV02PRH |

- Pushlock pull/turn reset switches are locked when pressed, and reset when pulled or turned clockwise.

Arrow Marked

Pushlock Pull/Turn Reset Switch (Solder Terminal)

Package quantity: 1

| Shape | Main Contact (NC) | Part No. |
|--|-------------------|----------------------|
| ø30mm Mushroom   | 1NC | AB6E-3BV01PRM |
| | 2NC | AB6E-3BV02PRM |
| ø40mm Mushroom   | 1NC | AB6E-4BV01PRM |
| | 2NC | AB6E-4BV02PRM |

- Pushlock pull/turn reset switches are locked when pressed, and reset when pulled or turned clockwise.

ø16 X6 Series Emergency Stop Switches (Unibody)

Dimensions

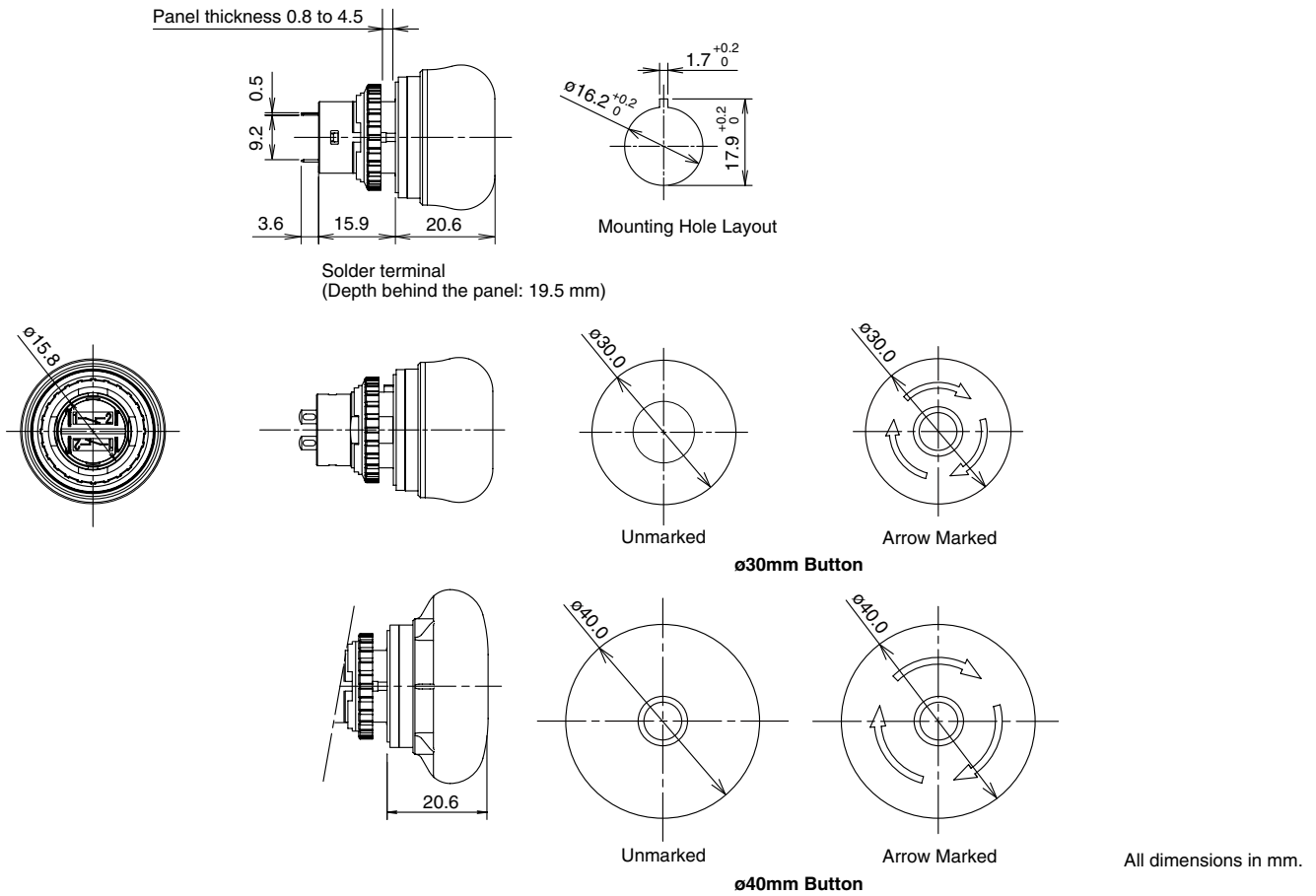

Mounting Hole Layout

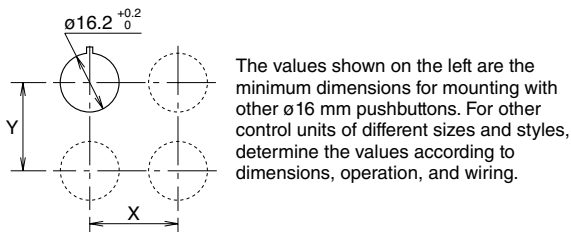

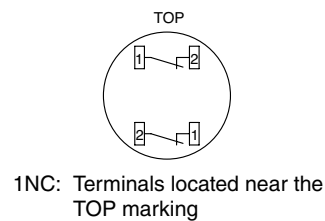

| | X | Y |
|---------------|------------|-----------|
| ø30 mm Button | 40 mm min. | 40mm min. |
| ø40 mm Button | 50 mm min. | 50mm min. |

Terminal Arrangement (Bottom View)



Accessories

| Shape | Material | Part No. | Package Quantity | Remarks |
|---|--------------------------------|-------------|------------------|--|
|  | Metal (nickel-plated brass) | MT-001 | 1 | <ul style="list-style-type: none"> Used to tighten the locking ring when installing the X6 switch onto a panel. |
|  | Polyamide | XA9Z-LNPN10 | 10 | <ul style="list-style-type: none"> Black |

X6 Series Emergency Stop Switches (Unibody) ø16

Nameplate (for ø16 Emergency Stop Switches)

Package quantity: 1

| Description | Legend | Part No. | Material | Background Color | Legend Color |
|------------------|----------------|-----------------|-----------|------------------|--------------|
| For ø30mm Button | Blank | HAAV-0 | Polyamide | Yellow | Black |
| | EMERGENCY STOP | HAAV-27 | | | |
| For ø40mm Button | Blank | HAAV4-0 | | | |
| | EMERGENCY STOP | HAAV4-27 | | | |

- Cannot be used with switch guard.

Dimensions

Nameplate for ø30mm Button HAAV-*

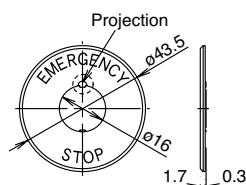

Nameplate for ø40mm Button HAAV4-*

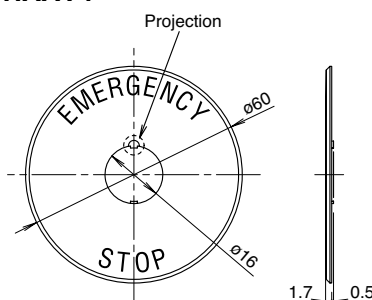

- Remove the projection from the nameplate using pliers, otherwise the switch cannot be installed.
- Panel thickness when using a nameplate: 0.5 to 3 mm

SEMI S2 Compliant Switch Guard

Package quantity: 1

| Shape | Material | Part No. | Remarks |
|---|-----------------|-----------------|---|
|  | Polyamide (PA6) | XA9Z-KG1 | <ul style="list-style-type: none"> • IP65 degree of protection • Color: yellow (Munsell 2.5Y8/10 or equivalent) • Cannot be used with nameplate. |

Switch Guard XA9Z-KG1

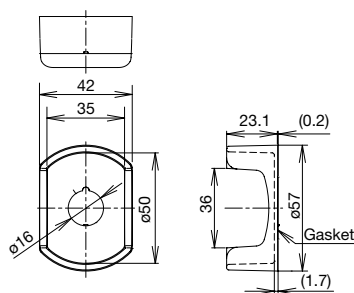

- Panel thickness when using a nameplate: 0.5 to 3 mm

Note:

Switch guards have been designed for applications in semiconductor manufacturing equipment only. Do not use the switch guards with emergency stop switches which are installed on other machines such as machine tools or food processing machines. Machinery Directive of the European Commission and IEC 60204-1 require that emergency stop switches be installed in a readily accessible area, and the usage of switch guards is not permitted.

Nameplates (white)

| Shape | Description | Part No. | Material | Plate Color | Legend |
|------------------|--------------------|------------------|-----------|----------------------|--------|
| For ø16mm Series | For ø29mm Mushroom | HAAV-0-W | Polyamide | White (Munsell N9.5) | Blank |
| | For ø49mm Mushroom | HAAV4-0-W | | | |

ø16 X6 Series Emergency Stop Switches (Unibody)

Safety Precautions

- Turn off power to the X6 series units before installation, removal, wiring, maintenance, and inspection. Failure to turn power off may cause electrical shocks or fire hazard.
- For wiring, use wires of proper size to meet the voltage and current requirements and solder properly. Improper soldering may cause overheating and create fire hazards.

Instructions

Panel Mounting

Remove the locking ring from the operator and check that the rubber gasket is in place. Insert the operator from panel front into the panel hole. Face the side with the projection upward, and tighten the locking ring using the locking ring wrench MT-001.

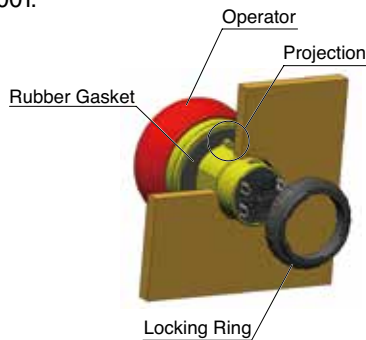

Notes for Panel Mounting

Using the locking ring wrench MT-001, tighten the locking ring to a torque of 0.88 N·m. Do not use pliers. Do not apply excessive force, otherwise the locking ring will become damaged.

Wiring

1. Applicable wire size is 1.25 mm² maximum.
2. Solder the terminals using a soldering iron at 310 to 350°C for 3 seconds maximum. Do not use flow or dip soldering. SnAgCu type lead-free solder is recommended. Make sure that the soldering iron touches the terminals only, not plastic parts. Do not apply external force such as bending the terminals or applying tensile force on the wires.

3. Use a non-corrosive rosin flux. To prevent the flux from entering the switch while soldering, face the terminals downward.

Correct



Incorrect

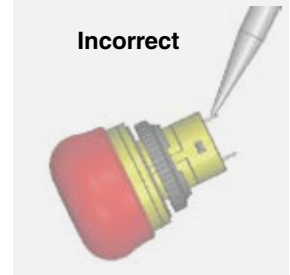

4. Because the terminal spacing is narrow, use protective tubes or heat shrinkable tubes to avoid burning the wire sheath or short circuit.
5. Apply force on the terminals in the vertical direction to the panel only, otherwise the terminals will be damaged.

Contact Bounce

When the button is reset by pulling or turning, the NC contacts will bounce. When designing a control circuit, take the contact bounce time into consideration (reference value: 20 ms).

Handling

Do not expose the switch to excessive shock and vibrations, otherwise the switch may be deformed or damaged, causing malfunction or operation failure.

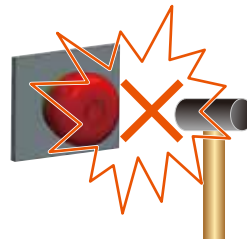

ø16 XA Series Emergency Stop Switches (Unibody)

Small, unibody emergency stop switches suitable for equipment with small mounting space. Requires only ø16mm × 19.5mm for installation.

- ø29mm and ø40mm mushroom operators
- Degree of protection IP65 and IP40 (IEC 60529)
- Dark red (Munsell 5R4/12) and bright red (Munsell 7.5R4.5/14) colors for operators of emergency stop switches, and yellow/gray for stop switch operators.
- Gold-plated crossbar contacts
- Push-to-lock, pull or turn-to-reset operator
- UL, c-UL recognized. EN compliant.
- Safety lock mechanism (IEC 60947-5-5, 6.2)
- Direct opening action mechanism (IEC 60947-5-5, 5.2, IEC60947-5-1, Annex K)



Standards

| Applicable Standards | Mark | File No. or Organization |
|-----------------------------------|------|---------------------------------------|
| UL508 CSA C22.2 No.14 | | UL/c-UL Recognition File No.E68961 |
| EN60947-5-1 EN60947-5-5 (note) | | TÜV SÜD |
| | | EU Low Voltage Directive |
| GB14048.5 | | CCC No. 2008010305286343 |

Note: Except for stop switch (yellow and gray button)

Contact Ratings

| Rated Insulation Voltage (Ui) | | 250V | | | |
|-------------------------------|------------|------------------------|------|-------|------|
| Thermal Current (Ith) | | 5A | | | |
| Rated Operating Voltage (Ue) | | 30V | 125V | 250V | |
| Rated Operating Current | AC 50/60Hz | Resistive Load (AC-12) | — | 5A | 3A |
| | | Inductive Load (AC-15) | — | 3A | 1.5A |
| | DC | Resistive Load (DC-12) | 2A | 0.4A | 0.2A |
| | | Inductive Load (DC-13) | 1A | 0.22A | 0.1A |

- Minimum applicable load: 5V AC/DC, 1 mA (reference value) (May vary depending on the operating conditions and load.)
- The rated operating currents are measured at resistive/inductive loads as specified in IEC 60947-5-1.

Specifications





| | |
|--|--|
| Applicable Standards | IEC 60947-5-1, EN 60947-5-1 IEC 60947-5-5 (Note), EN 60947-5-5 (Note) JIS C8201-5-1, UL508, CSA C22.2 No.14 GB14048.5 |
| Operating Temperature | -25 to +60°C (no freezing) |
| Storage Temperature | -45 to +80°C (no freezing) |
| Operating Humidity | 45 to 85% RH (no condensation) |
| Operating Force | Push-to-lock: 10.5N Pull to reset: 10N Turn to reset: 0.16 N·m |
| Minimum Force Required for Direct Opening Action | 40N |
| Minimum Operator Stroke Required for Direct Opening Action | 4.0 mm |
| Maximum Operator Stroke | 4.5 mm |
| Contact Resistance | 50 mΩ maximum (initial value) |
| Insulation Resistance | 100 MΩ minimum (500V DC megger) |
| Overvoltage Category | II |
| Impulse Withstand Voltage | 2.5 kV |
| Pollution Degree | 3 |
| Operating Frequency | 900 operations/hour |
| Shock Resistance | Operating extremes: 150 m/s ² Damage limits: 1000 m/s ² |
| Vibration Resistance | Operating extremes: 10 to 500 Hz, amplitude 0.35mm, acceleration 50 m/s ² Damage limits: 10 to 500 Hz, amplitude 0.35 mm, acceleration 50 m/s ² |
| Durability | Mechanical: 250,000 Electrical: 100,000 250,000 (24V AC/DC, 100mA) |
| Degree of Protection | IP65, IP40 (IEC 60529) |
| Short-circuit Protection | 250V/10A fuse (Type aM IEC 60269-1/IEC 60269-2) |
| Conditional Short-circuit Current | 1000A |
| Terminal Style | Solder terminal, Solder/tab #110 terminal |
| Recommended Tightening Torque for Locking Ring | 0.88 N·m |
| Applicable Wire Size | 1.25 mm ² maximum (AWG16 maximum) |
| Terminal Soldering Condition | 310 to 350°C, within 3 seconds |
| Weight (approx.) | ø29mm mushroom: 14g ø40mm mushroom: 17g |

Note: Except for stop switches (operator color: yellow and gray)

ø16 XA Series Emergency Stop Switches (Unibody)

XA Series

Pushlock Pull/Turn Reset (Solder Terminal)

| Shape | Contact | Part No. | | ① Operator Color Code |
|--|---------|----------------------------|-----------------------------|--------------------------|
| | | IP40 (contact part: black) | IP65 (contact part: yellow) | |
| ø29mm Mushroom   | 1NC | XA1E-BV3U01K ① | XA1E-BV3U01 ① | R: red RH: bright red |
| | 2NC | XA1E-BV3U02K ① | XA1E-BV3U02 ① | |
| ø40mm Mushroom   | 1NC | XA1E-BV4U01K ① | XA1E-BV4U01 ① | |
| | 2NC | XA1E-BV4U02K ① | XA1E-BV4U02 ① | |

• Solder/tab #110 terminal is also available. Specify "T" before ① in the Ordering No.
XA1E-BV3U02KR → XA1E-BV3U02KTR

Dimensions

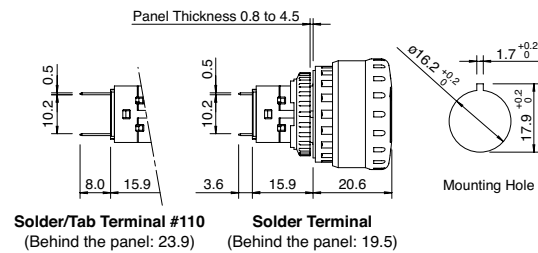

Terminal Arrangement (Bottom View)

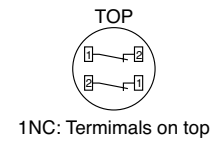

Mounting Hole Layout

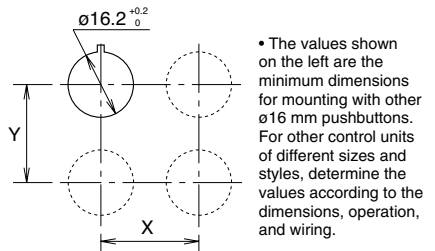

ø29 mm Mushroom

ø40 mm Mushroom

All dimensions in mm.

| | X | Y |
|----------------|---------------|---|
| ø29mm Mushroom | 40 mm minimum | |
| ø40mm Mushroom | 50 mm minimum | |

ø16 XA Series Emergency Stop Switches (w/Removable Contact Block)

The World's First ø16 mm, 4-contact Emergency Stop Switch. Compact size - only 27.9 mm deep behind the panel. Reliable "Safe break action."

- The depth behind the panel is only 27.9 mm for 1 to 4 contacts, both on illuminated and non-illuminated.
- IDEC's original "Safe break action" ensures that the contacts open when the contact block is detached from the operator.
- 1 to 4NC main contacts and 1NO monitor contact
- Push-to-lock, Pull or Turn-to-reset operator
- Direct opening action mechanism (IEC 60947-5-5, 5.2, IEC60947-5-1, Annex K)
- Safety lock mechanism (IEC 60947-5-5, 6.2)
- Degree of protection IP65 (IEC 60529)
- Two operator sizes: ø29 and ø40 mm
- Dark red (Munsell 5R4/12) or bright red (Munsell 7.5R4.5/14) colors are available for the operator of non-illuminated emergency stop switches, and gray for stop switch operators.
- UL, c-UL recognized. EN compliant

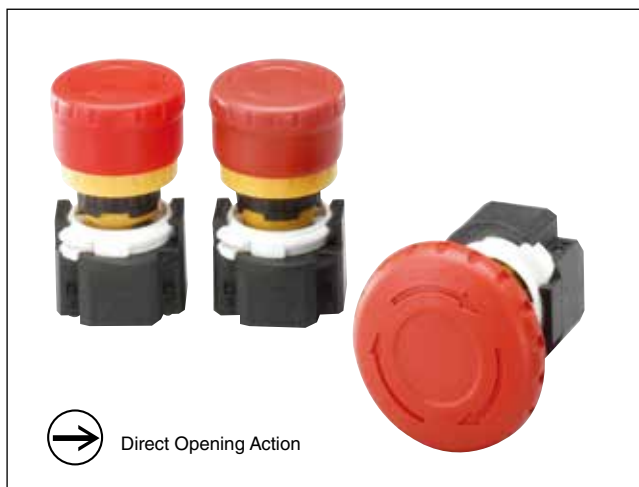

Standards

| Applicable Standards | Mark | File No. or Organization |
|--|------|--|
| UL508 CSA C22.2 No. 14 | | UL/c-UL Recognized, File No. E68961 |
| IEC60947-5-5 (Note) UL991 (Note) NFPA79 (Note) | — | UL File No. E305148 |
| EN60947-5-1 EN60947-5-5 (Note) | | TÜV SÜD |
| | | EU Low Voltage Directive |
| GB14048.5 | | CCC No. 2005010305150899 (Stop switch: CCC No. 2005010305150894) |

Note: Except for stop switches (button color: gray).

Contact Ratings

NC main contacts (black) /NO monitor contact (blue)

| Rated Insulation Voltage (Ui) | | 300V (illuminated part: 60V) | | | | |
|-------------------------------|---------------|------------------------------|------------------------|-------|-------|------|
| Rated Thermal Current (Ith) | | 5A | | | | |
| Rated Operating Voltage (Ue) | | 30V | 125V | 250V | | |
| Rated Operating Current | Main Contacts | AC 50/60 Hz | Resistive Load (AC-12) | — | 3A | 3A |
| | | | Inductive Load (AC-15) | — | 1.5A | 1.5A |
| | | DC | Resistive Load (DC-12) | 2A | 0.4A | 0.2A |
| | | | Inductive Load (DC-13) | 1A | 0.22A | 0.1A |
| Monitor Contacts | AC 50/60 Hz | Resistive Load (AC-12) | — | 1.2A | 0.6A | |
| | | Inductive Load (AC-14) | — | 0.6A | 0.3A | |
| | DC | Resistive Load (DC-12) | 2A | 0.4A | 0.2A | |
| | | Inductive Load (DC-13) | 1A | 0.22A | 0.1A | |

- Minimum applicable load: 5V AC/DC, 1 mA (reference value) (Operating area may vary according to the operating conditions and load types.)
- The rated operating currents are measured at resistive/inductive load types specified in IEC 60947-5-1.

Illumination Ratings

| Rated Voltage | Operating Voltage | Rated Current |
|---------------|-------------------|---------------|
| 24V AC/DC | 24V AC/DC ±10% | 11 mA |

Specifications





| | |
|--|---|
| Applicable Standards | IEC60947-5-1, EN60947-5-1 IEC60947-5-5 (Note), EN60947-5-5 (Note), JIS C8201-5-1, UL991 (Note), NFPA79 (Note), UL508, CSA C22.2 No.14, GB14048.5 |
| Operating Temperature | –25 to +60°C (no freezing) Illuminated: –25 to +55°C (no freezing) |
| Storage Temperature | –45 to +80°C |
| Operating Humidity | 45 to 85% RH (no condensation) |
| Operating Force | Push to lock: 10.5N Pull to reset: 10N Turn to reset: 0.16 N·m |
| Minimum Force Required for Direct Opening Action | 60N |
| Minimum Operator Stroke Required for Direct Opening Action | 4.0 mm |
| Maximum Operator Stroke | 4.5 mm |
| Contact Resistance | 50 mΩ maximum (initial value) |
| Insulation Resistance | 100 MΩ minimum (500V DC megger) |
| Overvoltage Category | II |
| Impulse Withstand Voltage | 2.5 kV |
| Pollution Degree | 3 (inside LED unit: 2) |
| Operation Frequency | 900 operations/hour |
| Shock Resistance | Operating extremes: 150 m/s ² Damage limits: 1000 m/s ² |
| Vibration Resistance | Operating extremes: 10 to 500 Hz, amplitude 0.35 mm acceleration 50 m/s ² Damage limits: 10 to 500 Hz, amplitude 0.35 mm acceleration 50 m/s ² |
| Mechanical Life | 250,000 operations minimum |
| Electrical Life | 100,000 operations min 250,000 operations min (24V AC/DC, 100 mA) |
| Degree of Protection | IP65 (IEC60529) |
| Short-circuit Protection | 250V/10A fuse (Type aM, IEC60269-1/IEC60269-2) |
| Conditional Short-circuit Current | 1000A |
| Terminal Style | Solder terminal, PC board terminal |
| Recommended Tightening Torque for Locking Ring | 0.88 N·m |
| Connectable Wire | 1.25 mm ² maximum (AWG16 maximum) |
| Soldering Conditions | 310 to 350°C, 3 seconds maximum |
| Weight | ø29 mm: 23g, ø40 mm: 28g |

Note: Except for stop switches (operator color: gray).

ø16 XA Series Emergency Stop Switches (w/Removable Contact Block)

Non-illuminated





Pushlock Pull/Turn Reset (Screw Terminal/PC Board Terminal)

| Shape | NC Main Contact | NO Monitor Contact | Part No. | | Operator Color Code |
|--|-----------------|--------------------|---------------------|----------------------|-------------------------------|
| | | | Solder Terminal | PC Board Terminal | |
| ø29mm Mushroom   | 1NC | — | XA1E-BV301 ① | XA1E-BV301V ① | R: Dark red RH: Bright red |
| | 2NC | — | XA1E-BV302 ① | XA1E-BV302V ① | |
| | 3NC | — | XA1E-BV303 ① | XA1E-BV303V ① | |
| | 4NC | — | XA1E-BV304 ① | XA1E-BV304V ① | |
| | 1NC | 1NO | XA1E-BV311 ① | XA1E-BV311V ① | |
| | 2NC | 1NO | XA1E-BV312 ① | XA1E-BV312V ① | |
| | 3NC | 1NO | XA1E-BV313 ① | XA1E-BV313V ① | |
| ø40mm Mushroom   | 1NC | — | XA1E-BV401 ① | XA1E-BV401V ① | |
| | 2NC | — | XA1E-BV402 ① | XA1E-BV402V ① | |
| | 3NC | — | XA1E-BV403 ① | XA1E-BV403V ① | |
| | 4NC | — | XA1E-BV404 ① | XA1E-BV404V ① | |
| | 1NC | 1NO | XA1E-BV411 ① | XA1E-BV411V ① | |
| | 2NC | 1NO | XA1E-BV412 ① | XA1E-BV412V ① | |
| | 3NC | 1NO | XA1E-BV413 ① | XA1E-BV413V ① | |

- Specify a color code in place of ① in the Part No.
- Terminal cover (XA9Z-VL2) is ordered separately.
- For EMO Switches, see page 58.

Illuminated

Pushlock Pull/Turn Reset (Screw Terminal/PC Board Terminal)

| Shape | NC Main Contact | NO Monitor Contact | Part No. | | Operator Color |
|--|-----------------|--------------------|----------------------|-----------------------|----------------|
| | | | Solder Terminal | PC Board Terminal | |
| ø29mm Mushroom   | 1NC | — | XA1E-LV301Q4R | XA1E-LV301Q4VR | Dark red only |
| | 2NC | — | XA1E-LV302Q4R | XA1E-LV302Q4VR | |
| | 3NC | — | XA1E-LV303Q4R | XA1E-LV303Q4VR | |
| | 4NC | — | XA1E-LV304Q4R | XA1E-LV304Q4VR | |
| | 1NC | 1NO | XA1E-LV311Q4R | XA1E-LV311Q4VR | |
| | 2NC | 1NO | XA1E-LV312Q4R | XA1E-LV312Q4VR | |
| | 3NC | 1NO | XA1E-LV313Q4R | XA1E-LV313Q4VR | |
| ø40mm Mushroom   | 1NC | — | XA1E-LV401Q4R | XA1E-LV401Q4VR | |
| | 2NC | — | XA1E-LV402Q4R | XA1E-LV402Q4VR | |
| | 3NC | — | XA1E-LV403Q4R | XA1E-LV403Q4VR | |
| | 4NC | — | XA1E-LV404Q4R | XA1E-LV404Q4VR | |
| | 1NC | 1NO | XA1E-LV411Q4R | XA1E-LV411Q4VR | |
| | 2NC | 1NO | XA1E-LV412Q4R | XA1E-LV412Q4VR | |
| | 3NC | 1NO | XA1E-LV413Q4R | XA1E-LV413Q4VR | |

- Terminal cover (XA9Z-VL2) is ordered separately.

XA Series Emergency Stop Switches (w/Removable Contact Block) $\phi 16$

Dimensions

Non-illuminated

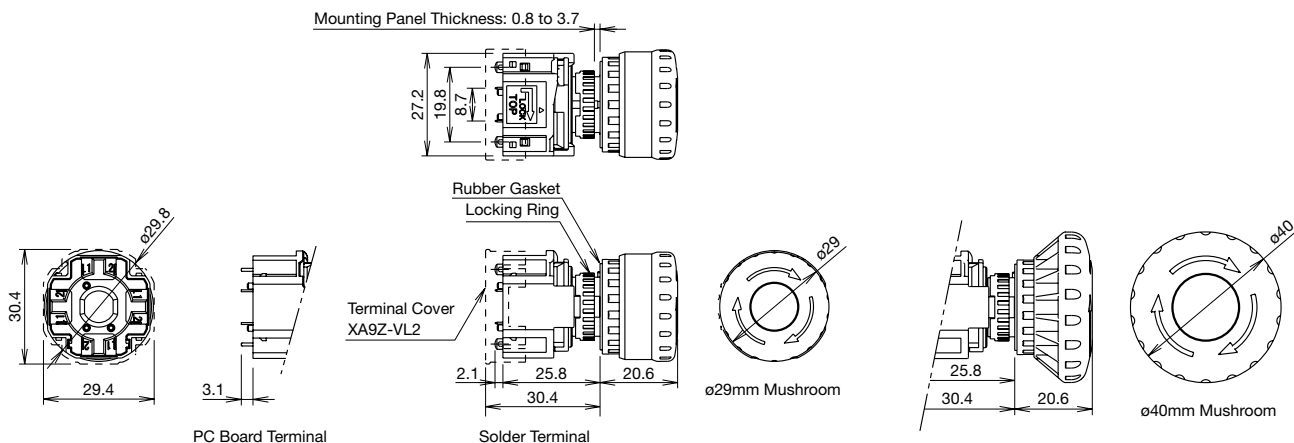

Illuminated

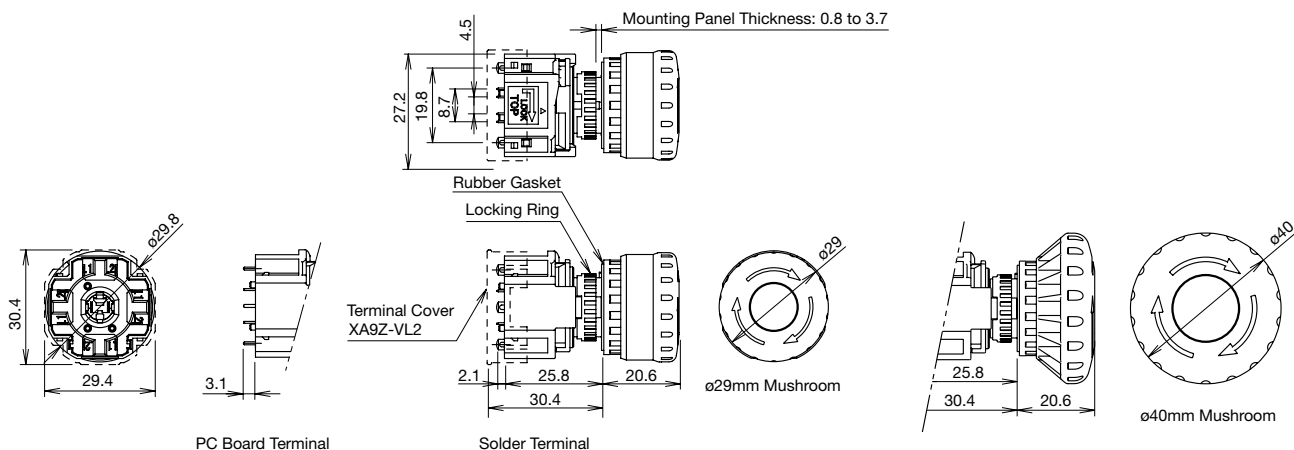

PC Board Layout (Bottom View)

Non-Illuminated

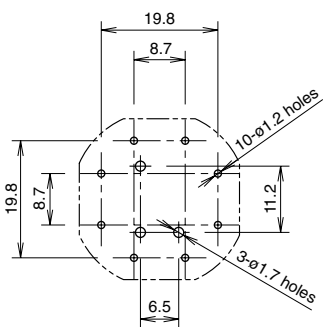

Illuminated

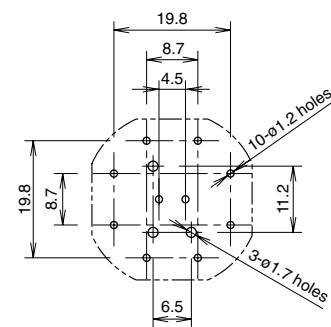

Panel Cut-out

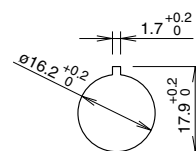

All dimensions in mm.

Mounting Hole Layout

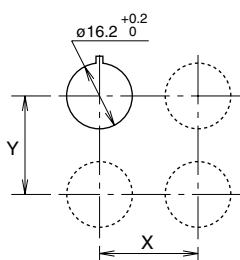

| | X | Y |
|-----------------------|---------------|---|
| $\phi 29$ mm Mushroom | 40 mm minimum | |
| $\phi 40$ mm Mushroom | 50 mm minimum | |

The values shown above are the minimum dimensions for mounting with other $\phi 16$ mm pushbuttons. For other control units of different sizes and styles, determine the values according to the dimensions, operation, and wiring convenience.

LED Unit Internal Circuit

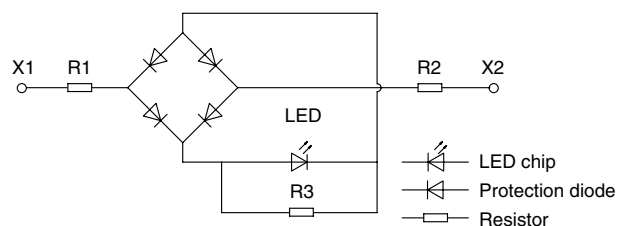

ø16 XA Series Emergency Stop Switches (w/Removable Contact Block)

Terminal Arrangement (Bottom View)

Non-illuminated

NC main contacts (black) only
NC main contacts (black):
Terminals 1-2

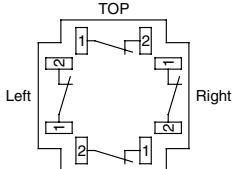

1NC: Terminals on right
2NC: Terminals on right and left
3NC: Terminals on right, left, and top

With NO monitor contacts (blue)

NC main contacts (black):
Terminals 1-2
NO monitor contacts (blue):
Terminals 3-4

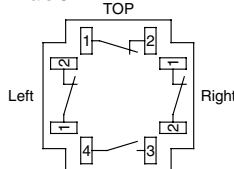

1NC: Terminals on top
2NC: Terminals on right and left

Illuminated

NC main contacts (black)
NC main contacts (black):
Terminals 1-2

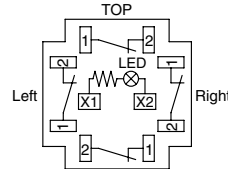

1NC: Terminals on right
2NC: Terminals on right and left
3NC: Terminals on right, left, and top

With NO monitor contacts (blue)

NC main contacts (black):
Terminals 1-2
NO monitor contacts (blue):
Terminals 3-4

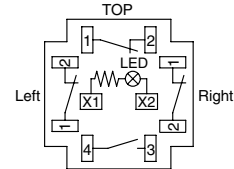

1NC: Terminals on top
2NC: Terminals on right and left

Nameplates (for ø16 Emergency Stop Switches)

| Description | Legend | Part No. | Material | Plate Color | Legend Color |
|--------------------|----------------|-----------------|-----------|-------------|--------------|
| For ø29mm Operator | (blank) | HAAV-0 | Polyamide | Yellow | Black |
| | EMERGENCY STOP | HAAV-27 | | | |
| For ø40mm Operator | (blank) | HAAV4-0 | | | |
| | EMERGENCY STOP | HAAV4-27 | | | |

For ø29mm Operator

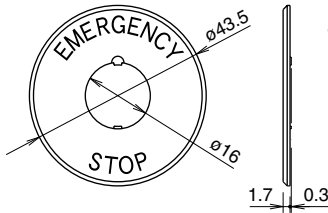

• Panel thickness when using the nameplate: 0.5 to 2 mm



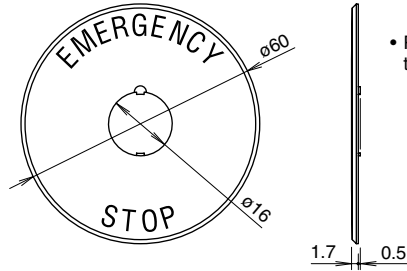

For ø40mm Operator



• Panel thickness when using the nameplate: 0.5 to 2 mm

All dimensions in mm.

Accessories and Replacement Parts

| Description & Shape | Material | Part No. | Ordering No. | Package Quantity | Remarks |
|--|-----------------------------|--------------------|---------------------|------------------|---|
| Ring Wrench  | Metal (nickel-plated brass) | MT-001 | MT-001 | 1 | • Used to tighten the locking ring when installing the XA emergency stop switch onto a panel. |
| Locking Ring  | Polyamide | XA9Z-LN | XA9Z-LNPN10 | 10 | • Black |
| Terminal Cover  | PBT | XA9Z-VL2 | XA9Z-VL2PN02 | 2 | • White • Used for solder terminals. • Also applicable to the XW series. |
| LED Unit  | For Solder Terminal | XA9Z-LED2R | XA9Z-LED2R | 1 | • Replacement LED unit for illuminated (for XA series only). |
| | For PC Board Terminal | XA9Z-LED2VR | XA9Z-LED2VR | | |
| LED Unit Removal Tool  | Stainless Steel | MT-101 | MT-101 | | • Used for removing the LED unit. |

XA Series Emergency Stop Switches (w/Removable Contact Block) $\varnothing 16$

Safety Precautions

- Turn off power to the XA series emergency stop switch before starting installation, removal, wiring, maintenance, and inspection of the relays. Failure to turn power off may cause electrical shock or fire hazard.
- Use the LED unit removal tool when replacing the LED unit to avoid burn on your hands.
- Use wires of the proper size to meet the voltage and current requirements, and solder the wires correctly. If soldering is incomplete, the wire may heat during operation, causing fire hazard.

Instructions

Removing the Contact Block

First unlock the operator button. While pushing up the white bayonet ring, using a small screwdriver (width: 2.5 to 3 mm) if necessary, turn the contact block counterclockwise and pull out. **Do not exert excessive force when using a screwdriver, otherwise the bayonet ring may be damaged.**

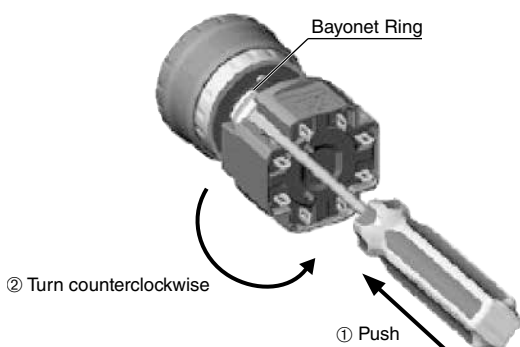

Notes for Removing the Contact Block

1. When the contact block is removed, the monitor contact (NO contact) is closed.
2. While removing the contact block, do not exert excessive force, otherwise the switch may be damaged.

Panel Mounting

Remove the locking ring from the operator and check that the rubber gasket is in place. Insert the operator from panel front into the panel hole. Face the side with the anti-rotation protrusion on the operator upward, and tighten the locking ring.

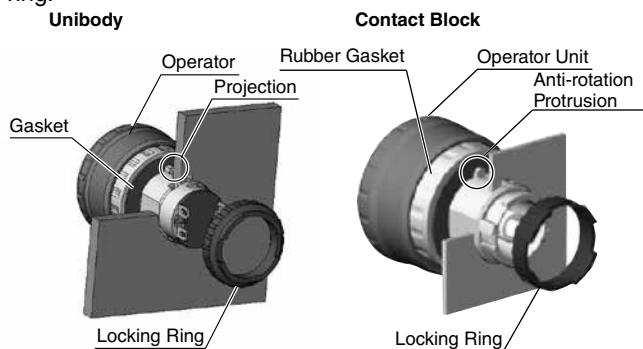

Notes for Panel Mounting

To mount the XA emergency stop switches onto a panel, tighten the locking ring to a tightening torque of 0.88 N·m maximum using ring wrench MT-001. Do not use pliers. Do not exert excessive force, otherwise the locking ring may be damaged.

Installing the Contact Block

First turn the bayonet ring to the unlocked position.

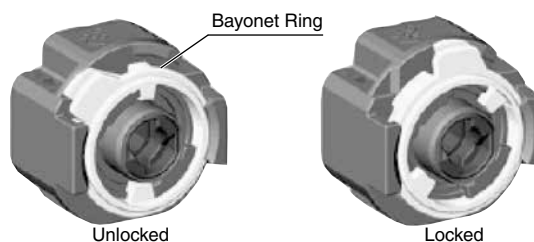

Align the small \blacktriangle marking on the edge of the operator base with the TOP marking on the contact block. Press the contact block onto the operator and turn the contact block clockwise until the bayonet ring clicks.

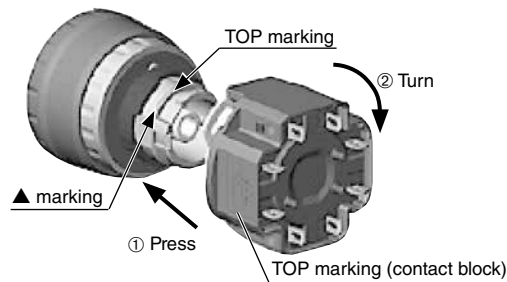

Notes for Installing the Contact Block

Check that the contact block is securely installed on the operator. When the emergency stop switch is properly assembled, the bayonet ring is in place as shown below.

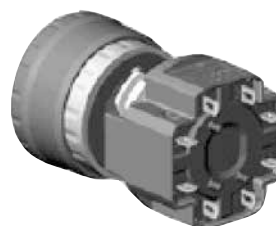

Removing the LED Unit (Contact Block)

Pull out the LED unit while squeezing the latches on the LED unit using the LED unit removal tool (MT-101).

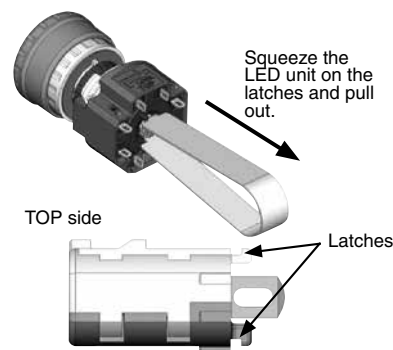

ø16 XA Series Emergency Stop Switches (w/Removable Contact Block)

Installing the LED Unit (with Removable Contact Block)

Align the top of the LED unit with the TOP marking on the contact block. Push the LED unit into the contact block.



Wiring

1. The applicable wire size is 1.25 mm² maximum.
2. Solder the terminal at a temperature of 310 to 350°C within 3 seconds using a soldering iron. Sn-Ag-Cu type is recommended when using lead-free solder. When soldering, do not touch the enabling switch with the soldering iron. Also ensure that no tensile force is applied to the terminal. Do not bend the terminal or apply excessive force to the terminal.
3. Use a non-corrosive rosin flux.
4. Because the terminal spacing is narrow, use protective tubes or heat shrinkable tubes to avoid burning of wire coating or short circuit.

Solder/Tab Terminal #110

1. Use #110 receptacles for 0.5mm-thick tabs.
2. Because the terminal spacing is narrow, use protective tubes or heat shrinkable tubes of 0.5mm minimum in thickness.
3. Do not apply force on the terminals in the direction other than vertical to the mounting panel, otherwise the terminals will be damaged.

PC Board Terminal

1. When mounting a contact block on a PC board, provide sufficient rotating space for the PC board when installing and removing the contact block.
2. When mounting an XA emergency stop switch on a PC board, make sure that the operator is securely installed.

About PC Board and Circuit Design

1. Use PC boards made of glass epoxy copper-clad laminated sheets of 1.6 mm in thickness, with double-sided through hole.
2. PC boards and circuits must withstand rated voltage and current, including the instantaneous current and voltage at switching.
3. The minimum applicable load is 5V AC/DC, 1 mA. This value may vary according to the operating environment and load.
4. Within the 2.8* mm areas shown in the figure below, terminals touch the PC board, resulting in possible short circuit on the printed circuit. When designing a PC board pattern, take this possibility into consideration.

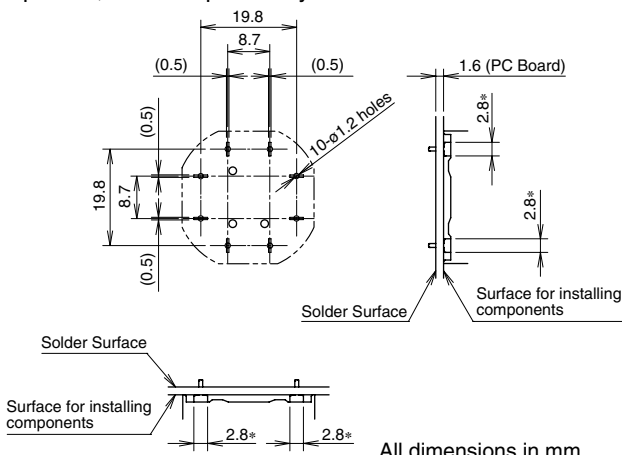

All dimensions in mm.

Installing Insulation Terminal Cover

To install the terminal cover (XA9Z-VL2), align the TOP marking on the terminal cover with TOP marking on the contact block, and press the terminal cover toward the contact block.

Note: For wiring, insert the wires into the holes in the terminal cover before soldering.

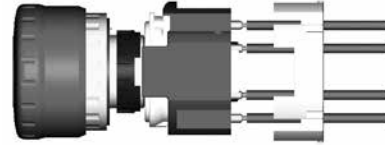

Contact Bounce

When the button is reset by pulling or turning, the NC main contacts will bounce. When pressing the button, the NO monitor contacts will bounce. When designing a control circuit, take the contact bounce time into consideration (reference value: 20 ms).

Nameplate

When anti-rotation is not required, remove the projection from the nameplate using pliers.

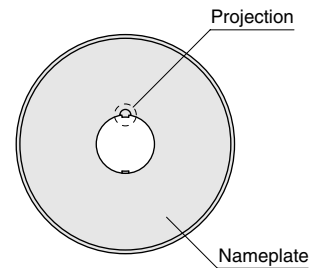

Handling

Do not expose the switch to excessive shock and vibration, otherwise the switch may be deformed or damaged, causing malfunction or operation failure.

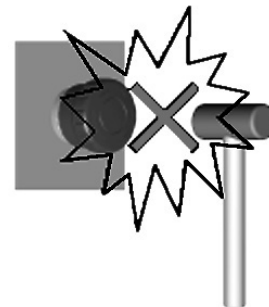

ø22 XW Series Emergency Stop Switches

ø22 mm, 4-contact Emergency Stop Switch. Compact size—only 37.1 mm deep behind the panel (screw terminal style 48.7 mm with terminal cover). Reliable “Safe break action.”

- The depth behind the panel is only 37.1 mm for 1 to 4 contacts (screw terminal style 48.7 mm with terminal cover).
- The same depth behind the panel for illuminated and non-illuminated switches.
- IDEC's original “Safe break action” ensures that the contacts open when the contact block is detached from the operator.
- 1 to 4NC main contacts and 1 or 2NO monitor contact
- Push-to-lock, Pull or Turn-to-reset operator
- Direct opening action mechanism (IEC60947-5-5, 5.2, IEC60947-5-1, Annex K)
- Safety lock mechanism (IEC60947-5-5, 6.2)
- Degree of protection IP65 (IEC60529)
- Screw terminal style is finger-safe (IP20).
- Two operator sizes: ø40 and ø60 mm
- Dark red (Munsell 5R4/12) or bright red (Munsell 7.5R4.5/14) colors are available for the non-illuminated operator.
- Push-ON illumination available (operator size: ø60)
- Connector style available to reduce wiring time and wiring mistakes.
- UL c-UL listed. EN compliant



Standards

| Applicable Standards | Mark | File No. or Organization |
|--|------|--|
| UL508 CSA C22.2 No.14 | | UL/c-UL Recognition File No. E68961 (solder terminal, PC board terminal) |
| | | UL/c-UL Listing File No. E68961 (screw terminal) |
| UL508 | | UL Recognition File No. E68961 (connector style) |
| IEC60947-5-5 (Note) UL991 NFFA79 | — | UL File No. E305148 (solder terminal, PC board terminal) |
| | | UL Listing File No. E305148 (screw terminal) |
| EN60947-5-1 EN60947-5-5 (Note) | | TÜV SÜD |
| | | EU low voltage directive |
| GB14048.5 | | CCC No. 2005010305150897 (except connector style) |

Note: Except for stop switch (yellow button)

Contact Ratings (NC main contacts/NO monitor contact)

| | | | | | | |
|-------------------------------|------------------------|----------------------------|------------------------|---------------|-------------|------|
| Rated Insulation Voltage (Ui) | Screw Terminal | | 250V | | | |
| | Solder Terminal | | 300V | | | |
| | PC Board Terminal | | 300V | | | |
| | Connector | | 125V | | | |
| Rated Thermal Current (Ith) | | 5A (connector style: 2.5A) | | | | |
| Rated Operating Voltage (Ue) | | 30V | 125V | 250V (Note 3) | | |
| Rated Operating Current | Main Contacts | AC 50/60 Hz | Resistive Load (AC-12) | — | 5A (Note 1) | 3A |
| | | | Inductive Load (AC-15) | — | 3A (Note 2) | 1.5A |
| | | DC | Resistive Load (DC-12) | 2A | 0.4A | 0.2A |
| | Inductive Load (DC-13) | | 1A | 0.22A | 0.1A | |
| | Monitor Contacts | AC 50/60 Hz | Resistive Load (AC-12) | — | 1.2A | 0.6A |
| | | | Inductive Load (AC-14) | — | 0.6A | 0.3A |
| DC | | Resistive Load (DC-12) | 2A | 0.4A | 0.2A | |
| | Inductive Load (DC-13) | 1A | 0.22A | 0.1A | | |

- Minimum applicable load: 5V AC/DC, 1 mA (reference value) (Operating area depends on the operating conditions and load types.)
- The rated operating currents are measured at resistive/inductive load types specified in JIS C8201-5-1.

Note 1: Solder terminal/PC board terminal: 3A, Connector: 2.5A

Note 2: Solder terminal/PC board terminal: 1.5A

Note 3: Except for connector style.

Illumination Ratings

| Rated Voltage | Operating Voltage | Rated Current |
|---------------|-------------------|---------------|
| 24V AC/DC | 24V AC/DC ±10% | 15 mA |

Note: An LED lamp is built into the contact block and cannot be replaced.





Specifications

| | |
|--|--|
| Applicable Standards | IEC60947-5-1, EN60947-5-1 IEC60947-5-5 (Note), EN60947-5-5 JIS C8201-5-1, UL508, UL991, NFFA79, CSA C22.2 No. 14, GB14048.5 |
| Operating Temperature | Non-illuminated: -25 to +60°C (no freezing) LED illuminated: -25 to +55°C (no freezing) |
| Storage Temperature | -45 to +80°C |
| Operating Humidity | 45 to 85% RH (no condensation) |
| Operating Force | Push to lock: 32N Pull to reset: 21N Turn to reset: 0.27 N·m |
| Minimum Force Required for Direct Opening Action | 80N |
| Minimum Operator Stroke Required for Direct Opening Action | 4.0 mm |
| Maximum Operator Stroke | 4.5 mm |
| Contact Resistance | 50 mΩ maximum (initial value) Connector style: 30 mΩ (Note) |
| Insulation Resistance | 100 MΩ minimum (500V DC megger) |
| Overvoltage Category | II |
| Impulse Withstand Voltage | 2.5 kV |
| Pollution Degree | 3 (connector style: 2) |
| Operation Frequency | 900 operations/hour |
| Shock Resistance | Operating extremes: 150 m/s ² Damage limits: 1000 m/s ² |
| Vibration Resistance | Operating extremes: 10 to 500 Hz, amplitude 0.35 mm, acceleration 50 m/s ² Damage limits: 10 to 500 Hz, amplitude 0.35 mm, acceleration 50 m/s ² |
| Mechanical Life | 250,000 operations minimum |
| Electrical Life | 100,000 operations minimum 250,000 operations minimum (24V AC/DC, 100 mA) |
| Degree of Protection | Panel front: IP65 (IEC 60529) Terminal Protection: IP20 (screw terminal, when using XW9Z-VL2MF) |
| Short-circuit Protection | 250V/10A fuse (Type aM, IEC60269-1/IEC60269-2) |
| Conditional Short-circuit Current | 1000A |
| Terminal Style | Solder terminal, PC board terminal, M3 screw terminal, Connector |
| Recommended Tightening Torque for Locking Ring | 2.0 N·m |
| Connectable Wire | Screw terminal: 0.75 to 1.25 mm ² (AWG18 to 16) Solder terminal / PC board terminal: 1.25 mm ² maximum (AWG16 maximum) Connector style: 0.3 to 0.85 mm ² (AWG22 to 18) |
| Soldering Conditions | 310 to 350°C, 3 seconds maximum |
| Recommended Tightening Torque for Terminal Screw | 0.6 to 1.0 N·m |
| Weight | ø40 mm: 72g ø60 mm: 81g |

Note: When connecting the applicable connector to a 1m wire of 0.33 mm² (AWG22).



ø22 XW Series Emergency Stop Switches

Non-illuminated Pushlock Pull / Turn Reset (Screw Terminal)

| Shape | NC Main Contact | NO Monitor Contact | Part No. | | ① Operator Color Code | |
|--|--|--------------------|---------------|------------------|-------------------------------|--------------|
| | | | IP20 | w/Terminal Cover | | |
| ø40mm Mushroom   | 1NC | — | XW1E-BV401MF① | XW1E-BV401M① | R: Dark red RH: Bright red | |
| | 2NC | — | XW1E-BV402MF① | XW1E-BV402M① | | |
| | 3NC | — | XW1E-BV403MF① | XW1E-BV403M① | | |
| | 4NC | — | XW1E-BV404MF① | XW1E-BV404M① | | |
| | 1NC | 1NO | XW1E-BV411MF① | XW1E-BV411M① | | |
| | 2NC | 1NO | XW1E-BV412MF① | XW1E-BV412M① | | |
| | 3NC | 1NO | XW1E-BV413MF① | XW1E-BV413M① | | |
| | 2NC | 2NO | XW1E-BV422MF① | XW1E-BV422M① | | |
| | ø60mm Mushroom   | 1NC | — | XW1E-BV501MF① | | XW1E-BV501M① |
| | | 2NC | — | XW1E-BV502MF① | | XW1E-BV502M① |
| 3NC | | — | XW1E-BV503MF① | XW1E-BV503M① | | |
| 4NC | | — | XW1E-BV504MF① | XW1E-BV504M① | | |
| 1NC | | 1NO | XW1E-BV511MF① | XW1E-BV511M① | | |
| 2NC | | 1NO | XW1E-BV512MF① | XW1E-BV512M① | | |
| | 3NC | 1NO | XW1E-BV513MF① | XW1E-BV513M① | | |
| | 2NC | 2NO | XW1E-BV522MF① | XW1E-BV522M① | | |



- Specify a color code in place of ① in the Part No.
- IP20 types can be connected to solid wires only.
- For EMO Switches, see page 58.

Non-illuminated Pushlock Pull/Turn Reset (Solder Terminal/PC Board Terminal)

| Shape | NC Main Contact | NO Monitor Contact | Part No. | | ① Operator Color Code |
|--|-----------------|--------------------|-----------------|-------------------|-------------------------------|
| | | | Solder Terminal | PC Board Terminal | |
| ø40mm Mushroom   | 1NC | — | XW1E-BV401① | XW1E-BV401V① | R: Dark red RH: Bright red |
| | 2NC | — | XW1E-BV402① | XW1E-BV402V① | |
| | 3NC | — | XW1E-BV403① | XW1E-BV403V① | |
| | 4NC | — | XW1E-BV404① | XW1E-BV404V① | |
| | 1NC | 1NO | XW1E-BV411① | XW1E-BV411V① | |
| | 2NC | 1NO | XW1E-BV412① | XW1E-BV412V① | |
| | 3NC | 1NO | XW1E-BV413① | XW1E-BV413V① | |
| | 2NC | 2NO | XW1E-BV422① | — | |

- Specify a color code in place of ① in the Part No.
- Terminal cover (XA9Z-VL2) is ordered separately.

Pushlock Pull/Turn Reset (Connector)

| Shape | NC Main Contact | NO Monitor Contact | Part No. | ① Operator Color Code |
|--|-----------------|--------------------|-----------------|-------------------------------|
| ø40mm Mushroom   | 3NC | — | XW1E-BV403V①-BC | R: Dark red RH: Bright red |

- Specify a color code in place of ① in the Part No.
- Applying for UL/c-UL listing. The switch unit (XW1E-BV) is UL/c-UL listed.
- See page 30 for applicable connectors.

XW Series Emergency Stop Switches ø22

LED Illuminated Pushlock Pull/Turn Reset (Screw Terminal)

| Shape | Illumination | Rated Voltage | NC Main Contact | NO Monitor Contact | Part No. | |
|---|--------------|---------------|-----------------|--------------------|------------------------|-----------------------|
| | | | | | IP20 | w/Terminal Cover |
| <p>ø40mm Mushroom</p> <p>LED</p> <p>24V AC/DC</p> <p>UL LISTED, UL LISTED, EMERGENCY STOP DEVICE, CE, CCC, RoHS</p> | LED | 24V AC/DC | 1NC | — | XW1E-LV401Q4MFR | XW1E-LV401Q4MR |
| | | | 2NC | — | XW1E-LV402Q4MFR | XW1E-LV402Q4MR |
| | | | 3NC | — | XW1E-LV403Q4MFR | XW1E-LV403Q4MR |
| | | | 4NC | — | XW1E-LV404Q4MFR | XW1E-LV404Q4MR |
| | | | 1NC | 1NO | XW1E-LV411Q4MFR | XW1E-LV411Q4MR |
| | | | 2NC | 1NO | XW1E-LV412Q4MFR | XW1E-LV412Q4MR |
| | | | 3NC | 1NO | XW1E-LV413Q4MFR | XW1E-LV413Q4MR |
| | | | 2NC | 2NO | XW1E-LV422Q4MFR | XW1E-LV422Q4MR |

- The operator color is red only.
- IP20 types can be connected to solid wires only.

LED Illuminated Pushlock Pull/Turn Reset (Solder Terminal/PC Board Terminal)

| Shape | Illumination | Rated Voltage | NC Main Contact | NO Monitor Contact | Part No. | |
|--|--------------|---------------|-----------------|--------------------|----------------------|-----------------------|
| | | | | | Solder Terminal | PC Board Terminal |
| <p>ø40mm Mushroom</p> <p>LED</p> <p>24V AC/DC</p> <p>FUL US, CE, CCC, RoHS</p> | LED | 24V AC/DC | 1NC | — | XW1E-LV401Q4R | XW1E-LV401Q4VR |
| | | | 2NC | — | XW1E-LV402Q4R | XW1E-LV402Q4VR |
| | | | 3NC | — | XW1E-LV403Q4R | XW1E-LV403Q4VR |
| | | | 4NC | — | XW1E-LV404Q4R | XW1E-LV404Q4VR |
| | | | 1NC | 1NO | XW1E-LV411Q4R | XW1E-LV411Q4VR |
| | | | 2NC | 1NO | XW1E-LV412Q4R | XW1E-LV412Q4VR |
| | | | 3NC | 1NO | XW1E-LV413Q4R | XW1E-LV413Q4VR |
| | | | 2NC | 2NO | XW1E-LV422Q4R | — |

- The operator color is red only.
- Terminal cover (XA9Z-VL2) is ordered separately.

Push-ON LED Illuminated Pushlock Pull/Turn Reset (Screw Terminal)

| Shape | Illumination | Rated Voltage | NC Main Contact | NO Monitor Contact | Part No. | |
|---|--------------|---------------|-----------------|--------------------|------------------------|-----------------------|
| | | | | | IP20 | w/Terminal Cover |
| <p>ø40mm Mushroom</p> <p>LED</p> <p>24V AC/DC</p> <p>UL LISTED, UL LISTED, EMERGENCY STOP DEVICE, CE, CCC, RoHS</p> | LED | 24V AC/DC | 3NC | — | XW1E-TV403Q4MFR | XW1E-TV403Q4MR |
| | | | 2NC | 1NO | XW1E-TV412Q4MFR | XW1E-TV412Q4MR |

- The operator color is red only.
- Push-ON is illuminated when the operator is latched, and turns off when reset.
- IP20 types can be connected to solid wires only.

Push-ON LED Illuminated Pushlock Pull/Turn Reset (Connector)

| Shape | Illumination | Rated Voltage | NC Main Contact | NO Monitor Contact | Part No. |
|--|--------------|---------------|-----------------|--------------------|--------------------------|
| <p>ø40mm Mushroom</p> <p>LED</p> <p>24V AC/DC</p> <p>3NC</p> <p>—</p> <p>FUL US, CE, CCC, RoHS</p> | LED | 24V AC/DC | 3NC | — | XW1E-TV403Q4VR-BC |

- The operator color is red only.
- Push-ON is illuminated when the operator is latched, and turns off when reset.
- See page 30 for applicable connectors.

ø22 XW Series Emergency Stop Switches

Dimensions (Non-Illuminated)

Screw Terminal (IP20)

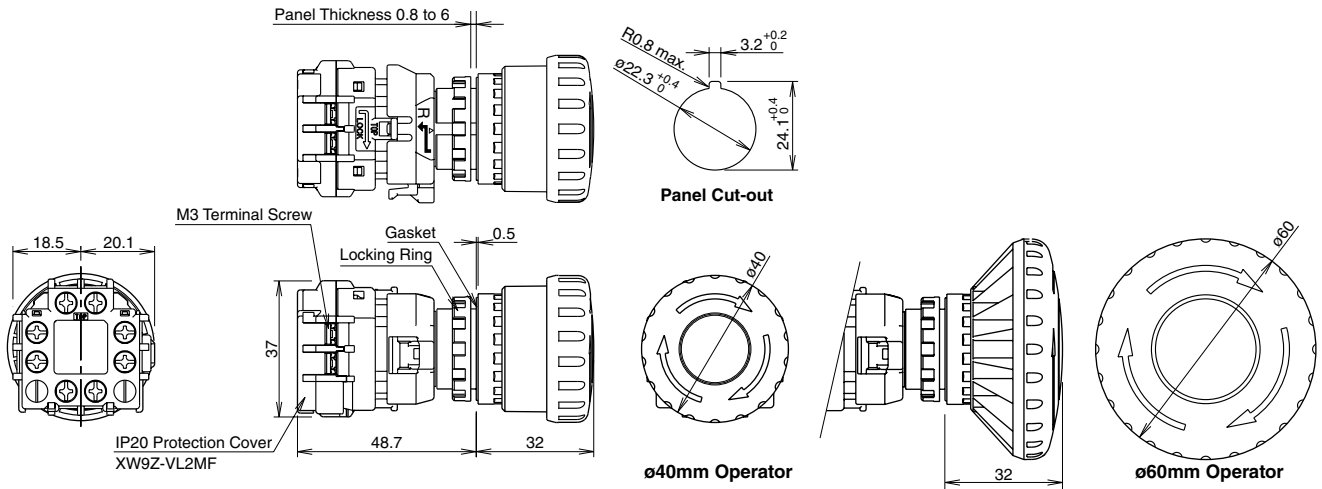

Screw Terminal (w/terminal cover)

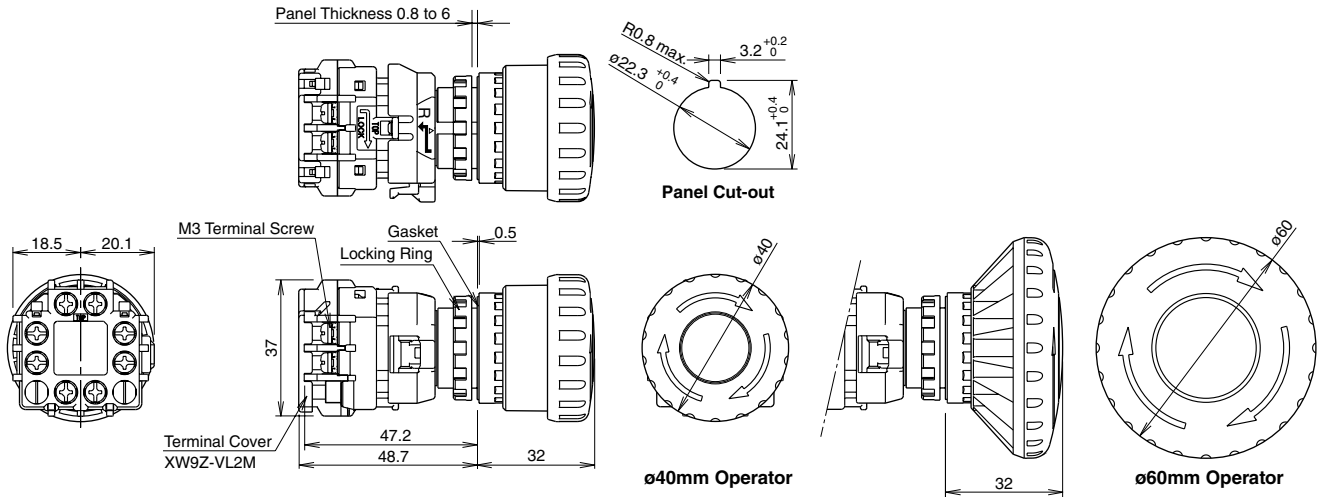

Solder Terminal and PC Board Terminal ø40mm Operator

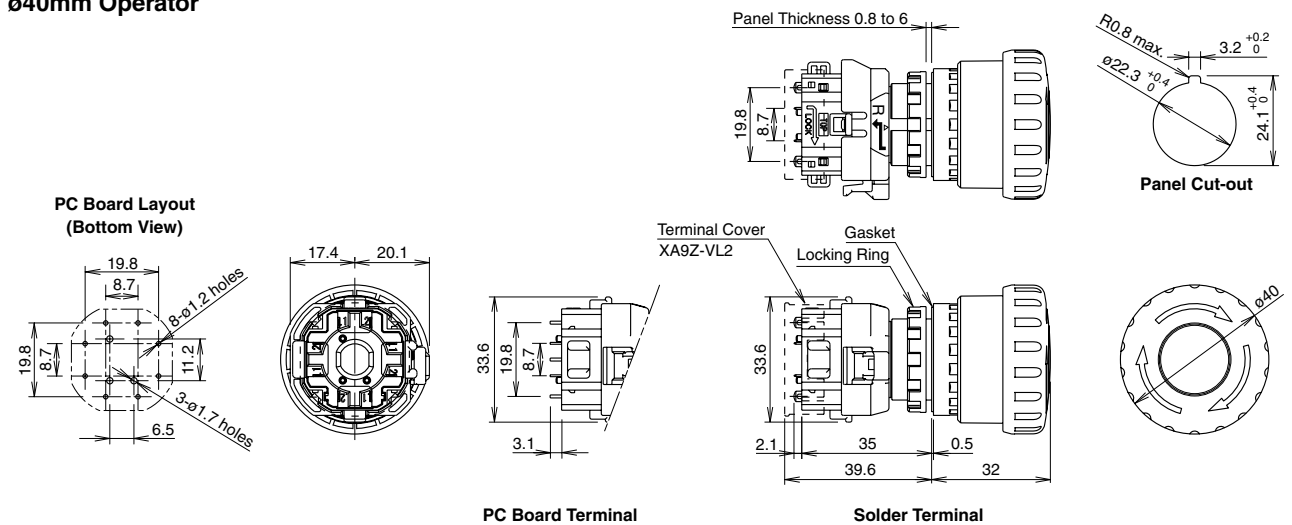

All dimensions in mm.

XW Series Emergency Stop Switches $\phi 22$

Dimensions (Illuminated)

Screw Terminal (IP20) LED Illuminated $\phi 40$ mm Operator

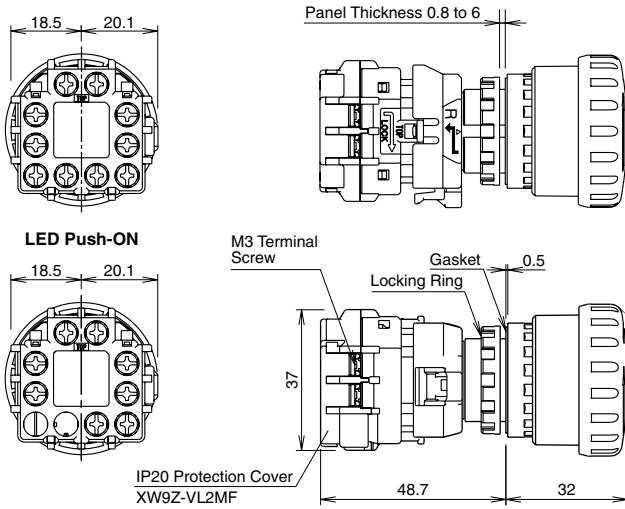

Screw Terminal (w/terminal cover) LED Illuminated $\phi 40$ mm Operator

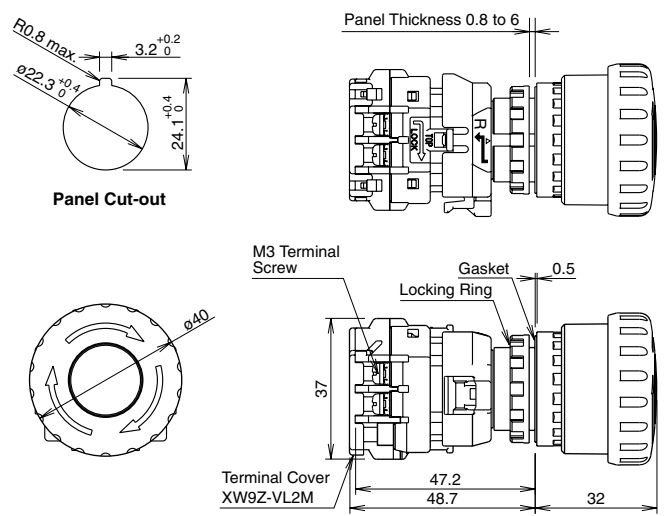

Solder Terminal and PC Board Terminal LED Illuminated $\phi 40$ mm Operator

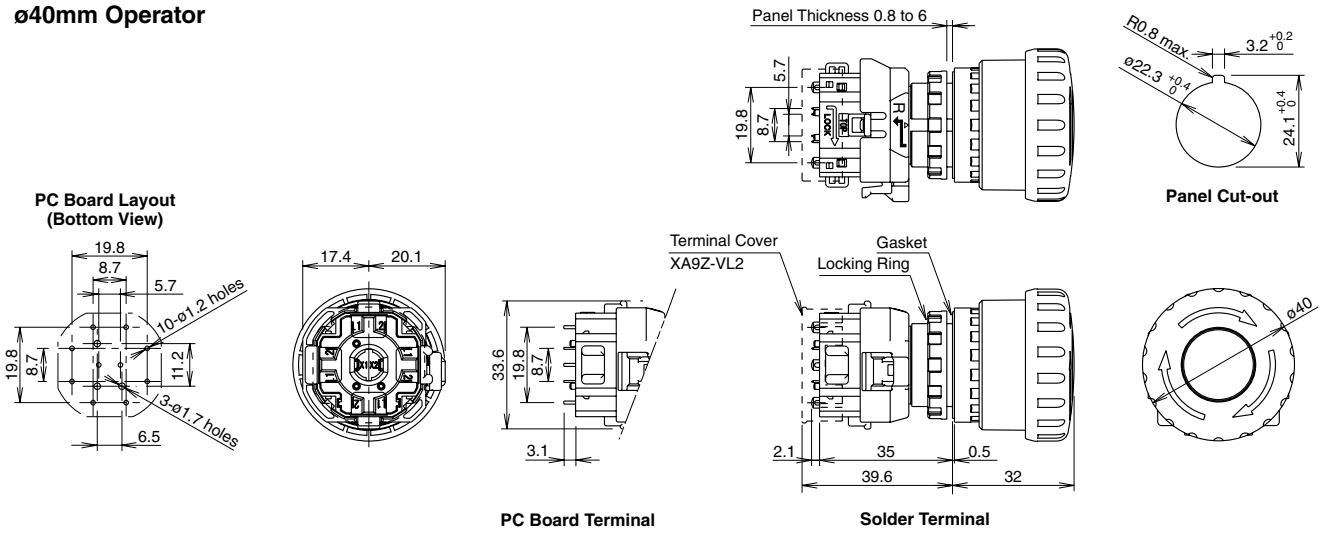

Dimensions (Connector Style)

Non-illuminated / LED Push-ON $\phi 40$ mm Operator

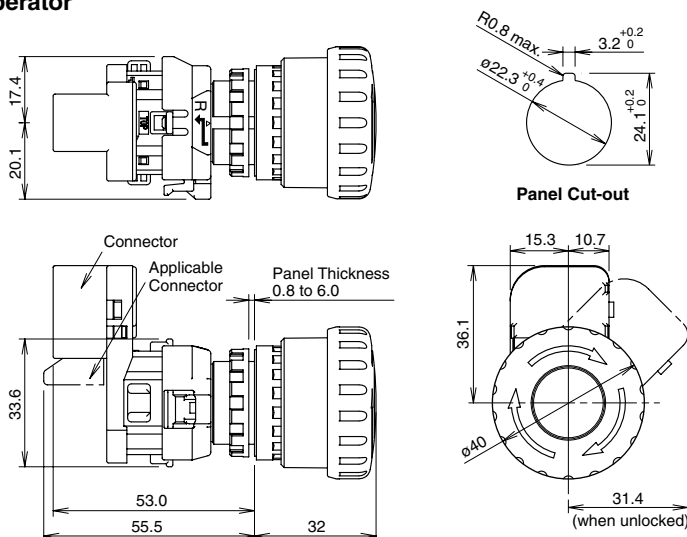

For applicable connectors, see page 30.

All dimensions in mm.

ø22 XW Series Emergency Stop Switches

Mounting Hole Layout

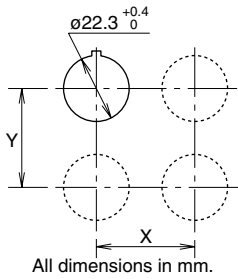

| | X | Y |
|--------------------------|---------------|---------------|
| Screw Terminal | 70 mm minimum | |
| Solder/PC Board Terminal | 50 mm minimum | |
| Connector Style | 50 mm minimum | 70 mm minimum |

• The values shown above are the minimum dimensions for mounting with other ø22mm pushbuttons. For other control units of different sizes and styles, determine the values according to the dimensions, operation, and wiring convenience.

LED Internal Circuit

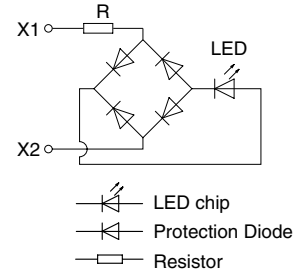

Terminal Arrangement (Bottom View)

Screw Terminal Non-illuminated

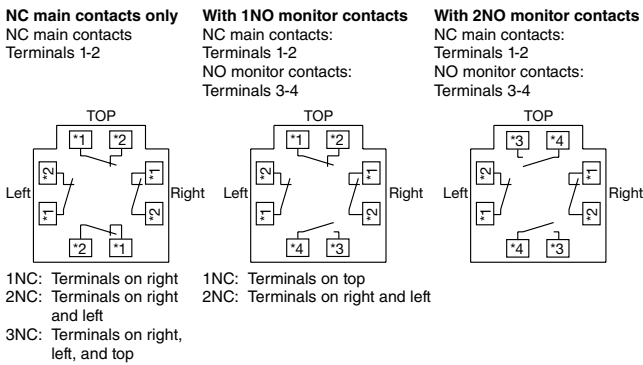

Screw Terminal Illuminated

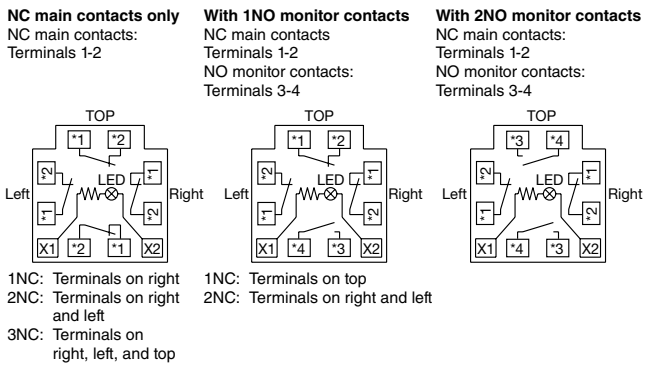

Screw Terminal Illuminated Push-ON

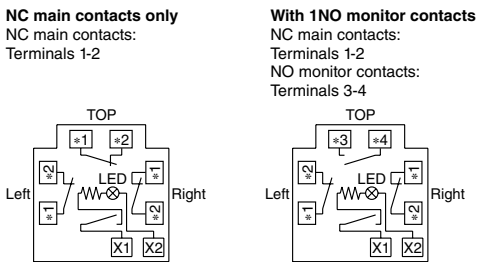

Terminal Marking Development

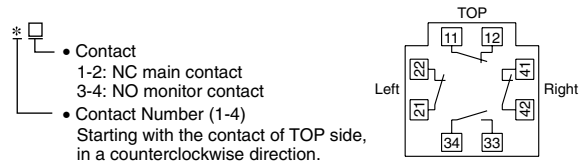

• On solder terminal and PC board terminal, the contact block is marked with contact codes (NC main contact 1-2: black, NO monitor contact 3-4: blue).

Solder Terminal / PC Board Terminal Non-illuminated

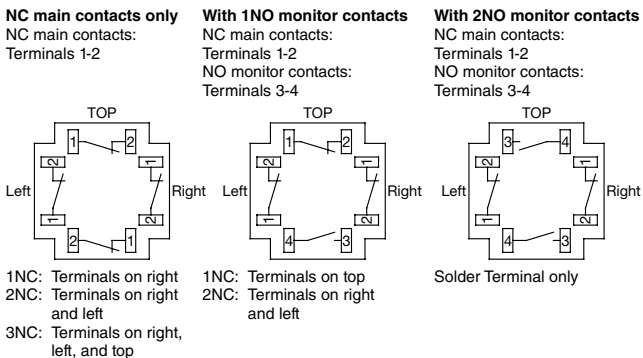

Solder Terminal / PC Board Terminal Illuminated

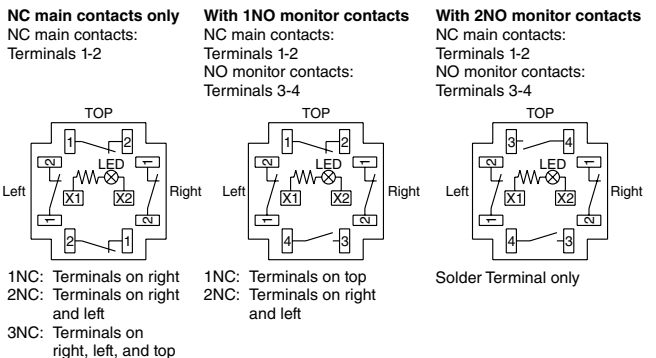

Connector Style Non-illuminated

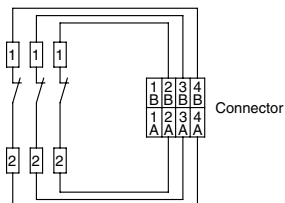



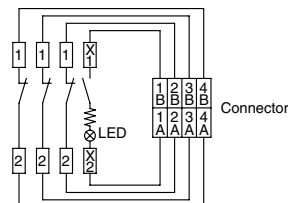



Connector Style Push-ON

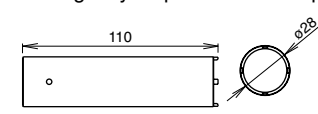

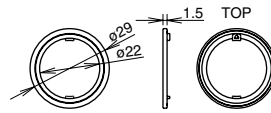
XW Series Emergency Stop Switches ø22

Accessories

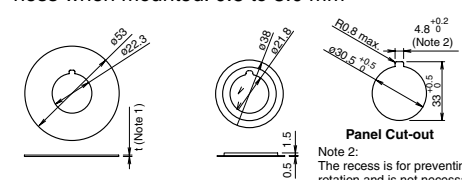
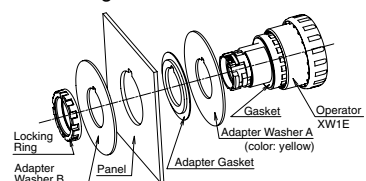
| Description & Shape | Material | Part No. | Ordering No. | Package Quantity | Remarks |
|---|--|-------------------|-----------------------|------------------|--|
|  | Metal (nickel-plated brass) (weight: approx. 150g) | MW9Z-T1 | MW9Z-T1 | 1 | <ul style="list-style-type: none"> Used to tighten the locking ring when installing the XW emergency stop switch onto a panel.  |
|  | Ring: Polyamide Gasket: Nitril rubber | HW9Z-RL | HW9Z-RLPN10 | 10 | <ul style="list-style-type: none"> The anti-rotation ring is used for preventing the operator from turning.  |
|  | PBT | XA9Z-VL2 | XA9Z-VL2PN02 | 2 | <ul style="list-style-type: none"> White Used for solder terminals. |
|  | PPE | XW9Z-VL2M | XW9Z-VL2MPN02 | 2 | <ul style="list-style-type: none"> Black Used for screw terminals. Attached to IP20 protection cover units. |
|  | Polyamide | XW9Z-VL2MF | XW9Z-VL2MFPN02 | 2 | <ul style="list-style-type: none"> Black Used on terminals for IP20 finger protection. Only solid wires can be used. The IP20 protection cover cannot be removed once installed. |
|  | Rubber on metal base | XW9Z-A30E | XW9Z-A30EPN02 | 2 | <ul style="list-style-type: none"> Yellow panel surface Used for installing XW1E emergency stop switches in ø30mm mounting hole. Can be used for XW1E emergency stop switches only. IP65 protection. Cannot be used with nameplates. Panel thickness when mounted: 0.8 to 3.0 mm  <p>Adapter Washer * (*: A or B) Adapter Gasket</p> <p>Note 1: Adapter washer thickness (t) A = 1.2 mm B = 0.8 mm</p> <p>Panel Cut-out Note 2: The recess is for preventing rotation and is not necessary for this product.</p> <ul style="list-style-type: none"> Panel Mounting  |

Notes:

- XW emergency stop switches of screw terminal are provided with a terminal cover.
- All dimensions in mm.

ø22 XW Series Emergency Stop Switches

Nameplate (for ø22 Emergency Stop Switches)

| Description | Legend | Part No. | Ordering No. | Package Quantity | Material | Plate Color | Legend Color |
|--------------------|----------------|------------------|----------------------|------------------|------------------|-------------|--------------|
| For ø40mm Operator | (blank) | HWAV-0 | HWAV-0 | 1 | Polyamide | Yellow | Black |
| | EMERGENCY STOP | HWAV-27 | HWAV-27 | | | | |
| For ø60mm Operator | (blank) | HWAV5-0 | HWAV5-0 | 10 | PBT | Yellow | Black |
| | EMERGENCY STOP | HWAV5-27 | HWAV5-27 | | | | |
| | EMERGENCY STOP | HWAV5F-27 | HWAV5F-27PN10 | | PET film sticker | | |

• EMERGENCY OFF and white nameplates (blank) also available. See page 61 and 64 for details.

For ø40mm Operator

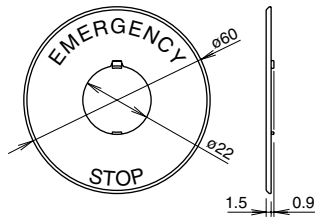

• Panel thickness when using the nameplate: 0.8 to 4.5 mm

For ø60mm Operator

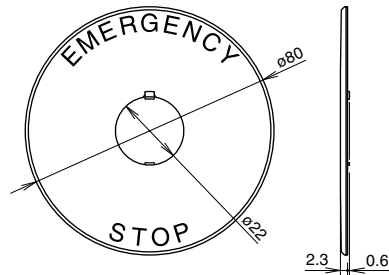

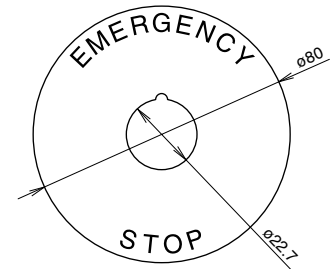

• Panel thickness when using the nameplate: 0.8 to 4 mm

Sticker Nameplate for ø60mm Operator



Maintenance Parts

| Description & Shape | Material | Part No. | Ordering No. | Package Quantity | Remarks |
|---|---------------|----------------|--------------------|------------------|---------|
| Locking Ring  | Polyamide | HW9Z-LN | HW9Z-LNPN05 | 5 | • Black |
| Washer  | Nitril rubber | HW9Z-WM | HW9Z-WMPN10 | 10 | • Black |

Safety Precautions

- Turn off power to the XW series emergency stop switch before starting installation, removal, wiring, maintenance, and inspection of the relays. Failure to turn power off may cause electrical shock or fire hazard.
- Use wires of the proper size to meet the voltage and current requirements, and solder the wires correctly. If soldering is incomplete, the wire may heat during operation, causing fire hazard.

Instructions

Removing the Contact Block

First unlock the operator button. Grab the bayonet ring ① and pull back the bayonet ring until the latch pin clicks ②, then turn the contact block counterclockwise and pull out ③.

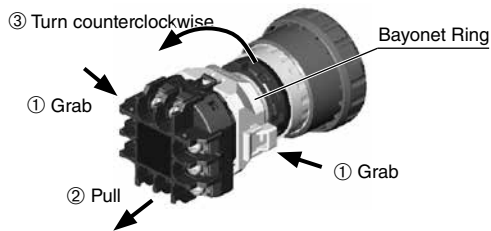

Notes for removing the contact block

1. When the contact block is removed, the monitor contact (NO contact) is closed.
2. While removing the contact block, do not exert excessive force, otherwise the switch may be damaged.
3. An LED lamp is built into the contact block for illuminated pushbuttons. When removing the contact block, pull the contact block straight to prevent damage to the LED lamp. If excessive force is exerted, the LED lamp may be damaged and fail to light.

Panel Mounting

Remove the locking ring from the operator and check that the rubber gasket is in place. Insert the operator from panel front into the panel hole. Face the side without thread on the operator with TOP marking upward, and tighten the locking ring using ring wrench MW9Z-T1 to a torque of 2.0 N·m maximum.

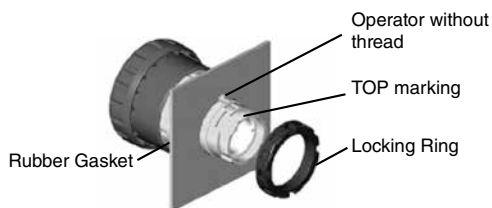

Notes for Panel Mounting

To prevent the XW emergency stop switch from rotating when resetting from the latched position, use of an anti-rotation ring (HW9Z-RL) or a nameplate is recommended.

Installing the Contact Block

First unlock the operator button. Align the small t marking on the edge of the operator with the small t marking on the yellow bayonet ring. Hold the contact block, not the bayonet ring. Press the contact block onto the operator and turn the contact block clockwise until the bayonet ring clicks.

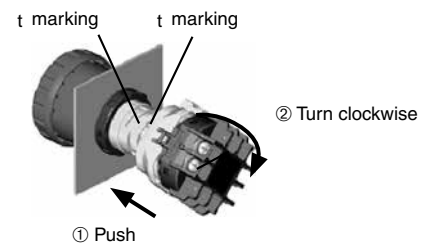

Notes for installing the contact block

Make sure that the bayonet ring is in the locked position. Check that the two projections on the bayonet ring are securely in place.

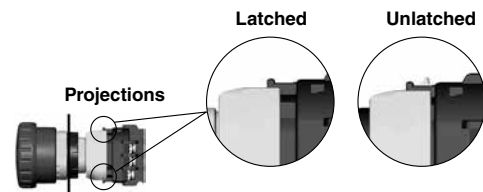

Wiring

Solder Terminal

1. The applicable wire size is 1.25 mm² maximum.
2. Solder the terminal at a temperature of 310 to 350°C within 3 seconds using a soldering iron. Sn-Ag-Cu type is recommended when using lead-free solder. When soldering, do not touch the enabling switch with the soldering iron. Also ensure that no tensile force is applied to the terminal. Do not bend the terminal or apply excessive force to the terminal.
3. Use a non-corrosive rosin flux.
4. Because the terminal spacing is narrow, use protective tubes or heat shrinkable tubes to avoid burning of wire coating or short circuit.

PC Board Terminal

1. When mounting a contact block on a PC board, provide sufficient rotating space for the PC board when installing and removing the contact block.
2. When mounting an XW emergency stop switch on a PC board, make sure that the operator is securely installed.
3. Do not solder by flow soldering. Otherwise, damage may be caused.

ø22 XW Series Emergency Stop Switches

Instructions

About PC Board and Circuit Design

1. Use PC boards made of glass epoxy copper-clad laminated sheets of 1.6 mm in thickness, with double-sided through hole.
2. PC boards and circuits must withstand rated voltage and current, including the instantaneous current and voltage at switching.
3. The minimum applicable load is 5V AC/DC, 1 mA. This value may vary according to the operating environment and load.
4. Within the 2.8* mm areas shown in the figure below, terminals touch the PC board, resulting in possible short circuit on the printed circuit. When designing a PC board pattern, take this possibility into consideration.

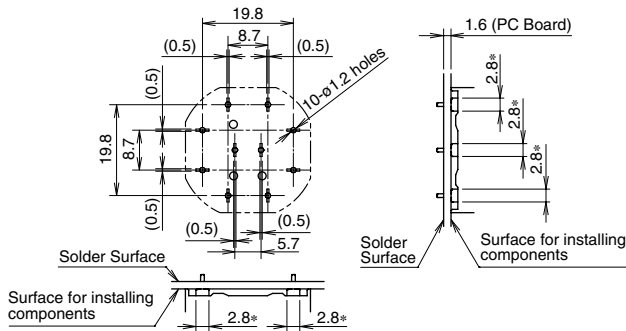

Screw Terminal

Applicable Crimping Terminals

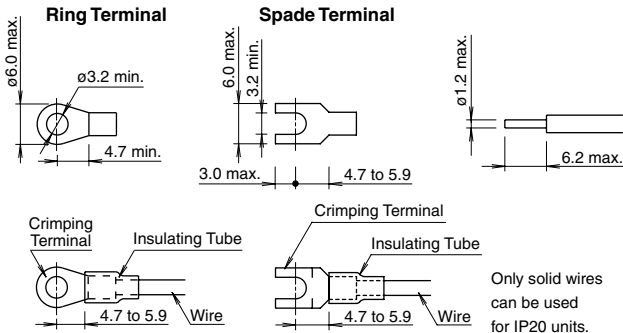

1. Wire thickness: 0.75 to 1.25 mm² (AWG18 to 16)
- Be sure to install an insulating tube on the crimping terminal.
2. Tighten the M3 terminal screw to a tightening torque of 0.6 to 1.0 N·m.

Connector

1. Connector shape
 - Tyco Electronics, D-2000 series Part No. 1376009-1 (tab header, board mount)
2. Applicable connectors (to be supplied by user)
 - Tyco Electronics, D-2000 series Part No. 1-1318119-4 (receptacle housing)
 - Tyco Electronics, D-2000 series Part No. 1318107-1 (receptacle contact)
3. To prepare correct receptacles for the connector, read the instruction sheet and catalog of Tyco Electronics and understand the installation and wiring method.
4. Fasten the cable so that the connector is not pulled. Otherwise the switch may be deformed and damaged, causing malfunction or operation failure.

Installing & Removing Terminal Covers

XA9Z-VL2

To install the terminal cover, align the TOP marking on the terminal cover with TOP marking on the contact block, and press the terminal cover toward the contact block.



Note: For wiring, insert the wires into the holes in the terminal cover before soldering.

XW9Z-VL2M

To install the terminal cover, align the TOP marking on the terminal cover with the TOP marking on the contact block. Place the two projections on the bottom side of the contact block into the slots in the terminal cover. Press the terminal cover toward the contact block.

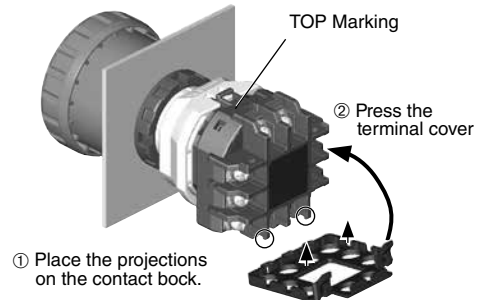

To remove the terminal cover, pull out the two latches on the top side of the terminal cover. Do not exert excessive force to the latches, otherwise the latches may break.

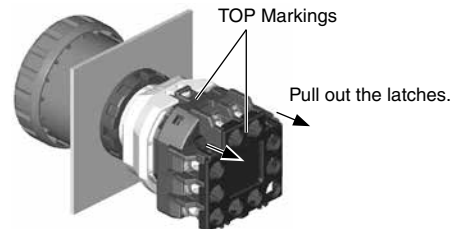

IP20 Protection Terminal Cover XW9Z-VL2MF

To install the IP20 protection cover, align the TOP marking on the cover with the TOP marking on the contact block, and press the cover toward the contact block.

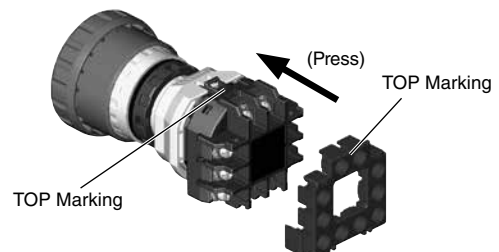

Notes:

1. Once installed, the XW9Z-VL2MF cannot be removed.
2. The XW9Z-VL2MF cannot be installed after wiring.
3. With the XW9Z-VL2MF installed, crimping terminals cannot be used. Use solid wires.
4. Make sure that the XW9Z-VL2MF is securely installed. IP20 cannot be achieved when installed loosely, and electric shocks may occur.

XW Series Emergency Stop Switches ø22

Instructions

Contact Bounce

When the button is reset by pulling or turning, the NC main contacts will bounce. When pressing the button, the NO monitor contacts will bounce.

When designing a control circuit, take the contact bounce time into consideration (reference value: 20 ms).

LED Illuminated Switches

An LED lamp is built into the contact block and cannot be replaced.

Installing the Anti-rotation Ring HW9Z-RL

Align the side without thread on the operator with TOP marking, the small ▲ marking on the anti-rotation ring, and the recess on the mounting panel.

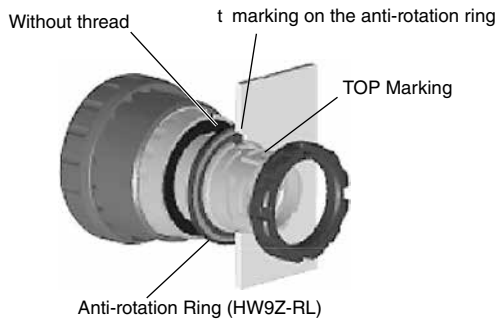

Installing the Nameplate

Align the side without thread on the operator with TOP marking, the projection on the nameplate, and the recess on the mounting panel.

Nameplate or Switch Guard

When anti-rotation is not required, remove the projection from the nameplate or switch guard using pliers.

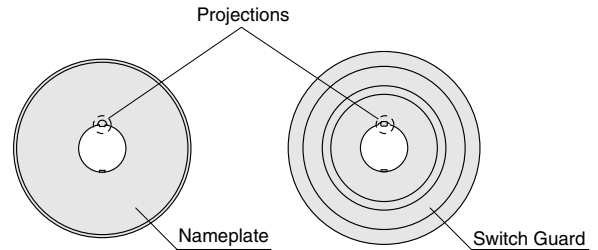

Handling

Do not expose the switch to excessive shocks and vibrations, otherwise the switch may be deformed or damaged, causing malfunction or operation failure.

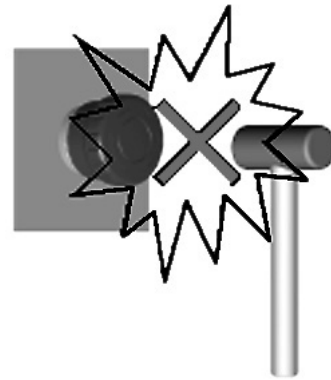

ø22 HW Series Emergency Stop Switches

Emergency Stop Switches (Unibody) Specifications

Standards

| Applicable Standards | Mark | File No. or Organization |
|---------------------------|------|------------------------------------|
| UL508 CSA C22.2 No. 14 | | UL/c-UL Listing File No. E55996 |
| EN60947-5-5 | | TÜV SÜD |
| | | EU Low Voltage Directive |
| GB14048.5 | | CCC No.2004010305132908 |

Specifications

| | |
|--|---|
| Operating Temperature | -25 to +60°C (no freezing) Illuminated units: -25 to +55°C |
| Storage Temperature | -40 to +80°C (no freezing) |
| Operating Humidity | 45 to 85% RH (no condensation) |
| Operating Force | 50N |
| Minimum Force Required for Direct Opening Action | 5.5 mm |
| Maximum Operator Stroke | 10 mm |
| Contact Resistance | 50 mΩ maximum (initial value) |
| Insulation Resistance | 100 MΩ minimum (500V DC megger) |
| Dielectric Strength | Between live and dead metal parts: Contacts: 2,500V AC, 1 minute Illuminated parts: 1,000V AC, 1 minute |
| Vibration Resistance | Damage limits: 30 Hz, amplitude 1.5 mm Operating extremes: 5 to 55 Hz, amplitude 0.5 mm |
| Shock Resistance | Damage limits: 1,000 m/s ² Operating extremes: 100 m/s ² |
| Operating Frequency | 900 operations/h |
| Life | Mechanical: 250,000 operations minimum Electrical: 100,000 operations minimum (at 900 operations/h, duty ratio 40%) |
| Degree of Protection | IP65 |
| Terminal Style | M3.5 screw |
| Weight | 49g (HW1E-BV402R) 56g (HW1E-LV402Q4R) |

Contact Ratings

| Rated Insulation Voltage (Ui) | | 250V | | | |
|--------------------------------|-------------|------------------------|------|------|-------|
| Rated Thermal Current (Ith) | | 10A | | | |
| Rated Operational Voltage (Ue) | | 24V | 110V | 220V | |
| Rated Operational Current | AC 50/60 Hz | Resistive Load (AC-12) | 6A | 3A | 3A |
| | | Inductive Load (AC-15) | 6A | 3A | 3A |
| | DC | Resistive Load (DC-12) | 6A | 2A | 1A |
| | | Inductive Load (DC-13) | 1.5A | 0.3A | 0.15A |

- Minimum applicable load (reference value): 3V AC/DC, 5 mA (Applicable range may vary with operating conditions and load types.)
- The operational current represents the classification by making and breaking currents (IEC 60947-5-1).

LED Lamp Ratings

| Rated Operating Voltage of Unit | LED Lamp | | |
|---------------------------------|----------------|----------------|---------------|
| | Part No. | Rated Voltage | Rated Current |
| 6V AC/DC | LSTD-6R | 6V AC/DC ±10% | 7 mA |
| 12V AC/DC | LSTD-1R | 12V AC/DC ±10% | 10 mA |
| 24V AC/DC | LSTD-2R | 24V AC/DC ±10% | 10 mA |

LED Internal Circuit

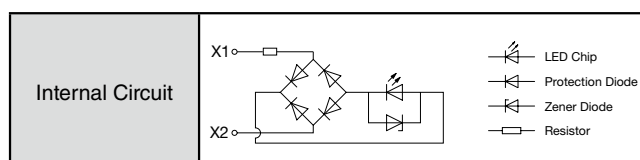

Pushlock Turn Reset Switches (Unibody)

| Shape | Contact | Part No. | Button Color |
|---|---------|--------------------|--------------|
| ø40mm Mushroom Pushlock Turn Reset HW1E-BV4  | 1NO-1NC | HW1E-BV411R | Red only |
| | 2NC | HW1E-BV402R | |

- When pressed, the button is held depressed. The button is released by turning clockwise.

Illuminated Pushlock Turn Reset Switches (Unibody)

| Shape | Contact | Part No. | Button Color |
|---|---------|----------------------|--------------|
| ø40mm Mushroom Pushlock Turn Reset HW1E-LV4  | 1NO-1NC | HW1E-LV411Q0R | Red only |
| | 2NC | HW1E-LV402Q0R | |

- When pressed, the button is held depressed. The button is released by turning clockwise.
- The illuminated pushlock turn reset switch does not contain a lamp. Order LED lamps separately. For lamps, see page 38.

HW Series Emergency Stop Switches ø22

Dimensions

HW1E-BV4

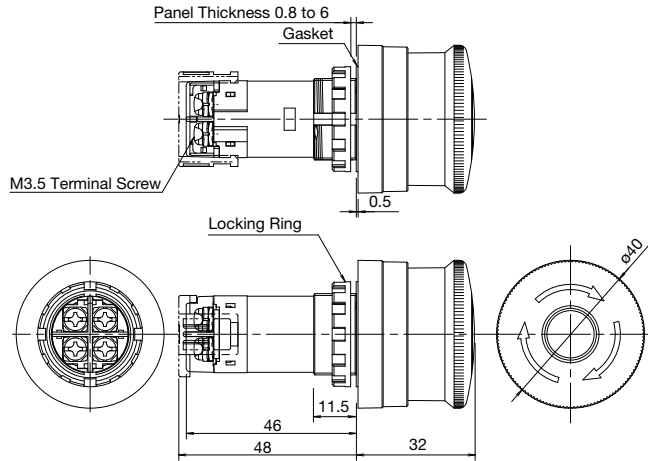

HW1E-LV4

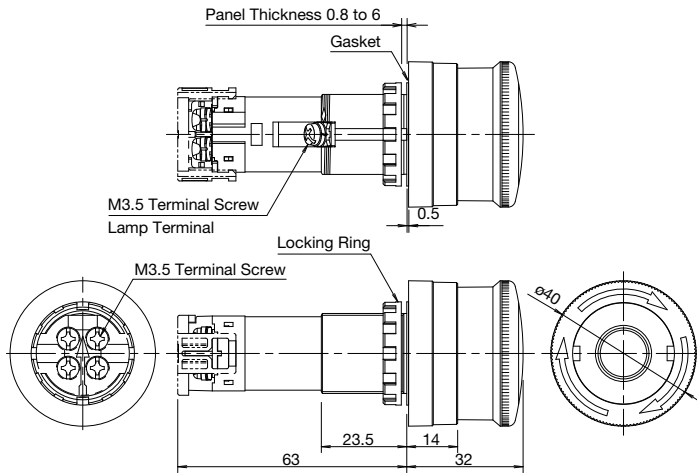

All dimensions in mm.

Mounting Hole

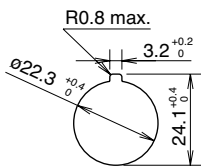

Determine the minimum mounting hole centers in consideration of convenience for wiring.

Terminal Arrangement (Bottom View)

HW1E-BV4

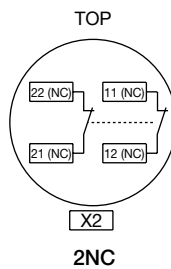
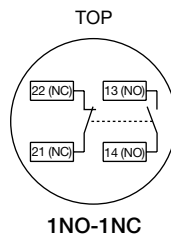

HW1E-LV4

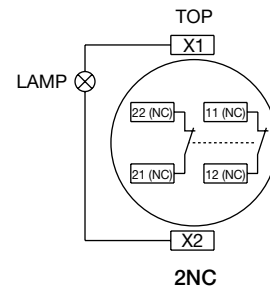
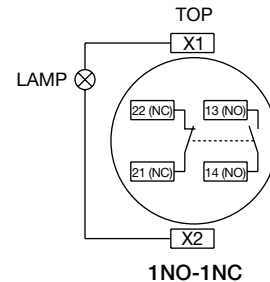

ø22 HW Series Emergency Stop Switches

Emergency Stop Switches (w/Removable Contact Block) Specifications

Standards

| Applicable Standards | Mark | File No. or Organization |
|----------------------|------|----------------------------|
| UL508 | | UL Listing File No. E68961 |
| CSA C22.2 No. 14 | | File No. LR92374 |
| EN60947-5-5 | | TÜV Rheinland |
| | | EU Low Voltage Directive |
| GB14048.5 | | CCC No.2005103050145656 |

Specifications

| | |
|--|--|
| Operating Temperature | -25 to +60°C (no freezing) |
| Storage Temperature | -40 to +80°C |
| Operating Humidity | 45 to 85% RH (no condensation) |
| Operating Force | 50N |
| Minimum Force Required for Direct Opening Action | 5.5 mm |
| Maximum Operator Stroke | 10 mm |
| Contact Resistance | 50 mΩ maximum (initial value) |
| Insulation Resistance | 100 MΩ minimum (500V DC megger) |
| Dielectric Strength | Between live and dead metal parts Between terminals of different poles Between terminals of the same pole 2,500V AC, 1 minute |
| Vibration Resistance | Damage limits: 30 Hz, amplitude 1.5 mm Operating extremes: 5 to 55 Hz, amplitude 0.5 mm |
| Shock Resistance | Damage limits: 1000 m/s ² Operating extremes: 100 m/s ² |
| Operating Frequency | 900 operations/h |
| Life | Mechanical: 500,000 operations minimum (push-pull: 250,000 operations) Electrical: 500,000 operations minimum (push-pull: 250,000 operations) (at 900 operations/h, duty ratio 40%) |
| Degree of Protection | IP65 (IEC 60529) |
| Terminal Style | M3.5 screw |
| Weight | 76g (HW1B-V322) 99g (HW1B-X422R) 54g (HW1B-Y202) 79g (HW1B-V422R-EMO) |

Contact Ratings

| | | |
|---------------|---|-----------------------|
| Contact Block | Rated Insulation Voltage | 600V |
| | Rated Thermal Current | 10A |
| | Contact Ratings by Utilization Category IEC 60947-5-1 | AC-15 (A600) DC-13 |

Characteristics

Contact Ratings by Utilization Category

| Operational Voltage | | | 24V | 48V | 50V | 110V | 220V | 440V |
|---------------------|-------------------|--|-----|-----|-----|------|------|------|
| Operational Current | AC 50/60 Hz | AC-12 Control of resistive loads and solid state loads | 10A | — | 10A | 10A | 6A | 2A |
| | | AC-15 Control of electromagnetic loads (> 72 VA) | 10A | — | 7A | 5A | 3A | 1A |
| Operational Current | DC | DC-12 Control of resistive loads and solid state loads | 8A | 4A | — | 2.2A | 1.1A | — |
| | | DC-13 Control of electromagnets | 4A | 2A | — | 1.1A | 0.6A | — |

Pushlock Turn Reset Switches (with Removable Contact Block)

| Shape | Contact | Part No. | Button Color |
|---|---------|------------|--|
| ø29mm Mushroom Pushlock Turn Reset HW1B-V3 | 1NC | HW1B-V301① | Specify a button color code in place of ① in the Part No. R: red Y: yellow |
| | 1NO-1NC | HW1B-V311① | |
| | 2NC | HW1B-V302① | |
| | 2NO-2NC | HW1B-V322① | |
| ø40mm Mushroom Pushlock Turn Reset HW1B-V4 | 1NC | HW1B-V401① | |
| | 1NO-1NC | HW1B-V411① | |
| | 2NC | HW1B-V402① | |
| | 2NO-2NC | HW1B-V422① | |
| ø60mm Mushroom Pushlock Turn Reset HW1B-V5 | 1NC | HW1B-V501① | |
| | 1NO-1NC | HW1B-V5⑥① | |
| | 2NC | HW1B-V502① | |
| | 2NO-2NC | HW1B-V522① | |

- Yellow buttons cannot be used as emergency stop switches in compliance with EN standards.
- When pressed, the button is held depressed. The button is released by turning clockwise.
- Pushlock turn reset switches with one or three contact blocks contain a dummy block.
- Safety lever lock HW9Z-LS is supplied with the switch.
- Other contact arrangements and gold-plated silver contacts are also available. See page 35.

HW Series Emergency Stop Switches ø22

Pushlock Key Reset Switches (with Removable Contact Block)

| Shape | Contact | Part No. | Button Color |
|---|---------|------------|--------------|
| ø40mm Mushroom Pushlock Key Reset HW1B-X4  | 1NC | HW1B-X401R | Red only |
| | 1NO-1NC | HW1B-X411R | |
| | 2NC | HW1B-X402R | |
| | 2NO-2NC | HW1B-X422R | |

- When pressed, the button is held depressed. The button is released by turning the key clockwise.
- Pushlock key reset switches with one or three contact blocks contain a dummy block.
- Two identical keys and safety lever lock HW9Z-LS are supplied with the switch.
- Safety lever lock HW9Z-LS is supplied with the switch.
- Other contact arrangements and gold-plated silver contacts are also available. See Part No. Development.

Push-Pull Switches (with Removable Contact Block)

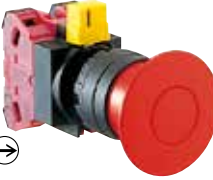
| Shape | Contact | Part No. | Button Color |
|--|---------|------------|--|
| ø40mm Mushroom Push-Pull (2-position) HW1B-Y2  | 1NC | HW1B-Y201① | Specify a button color code in place of ① in the Part No. R: red Y: yellow |
| | 1NO-1NC | HW1B-Y211① | |
| | 2NC | HW1B-Y202① | |

- The button is maintained at either pulled or depressed position.
- Push-pull switches are available with one or two contact blocks.
- Push-pull switches with one contact block contain a dummy block.
- Safety lever lock HW9Z-LS is supplied with the switch.

Accessory

Nameplate (for ø22 Emergency Stop Switches)

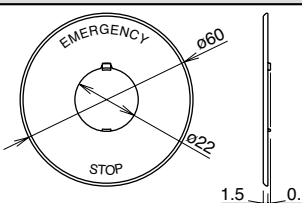
| Shape | Name | Part No. | Legend | Package Quantity | Remarks |
|---|--|-----------|----------------|------------------|--|
|  | Nameplate for Emergency Stop Switch (See page 36 for panel cut-out.) | HWAV-0-Y | (blank) | 1 | Background: Yellow Legend: Black Applicable panel thickness: 0.8 to 4.5 mm Material: Polyamide Not applicable for ø60 mm mushroom buttons. Legend "EMERGENCY STOP" is indicated outside a ø44mm circle. |
| | | HWAV-27-Y | EMERGENCY STOP | | |

- EMERGENCY OFF and white nameplates (blank) also available. See page 61 and 64 for details.

Part No. Development

Emergency Stop Switches (w/Removable Contact Block)

For emergency stop purposes, these switches must contain at least one NC contact block.

HW1B-V4 11 R -MAU

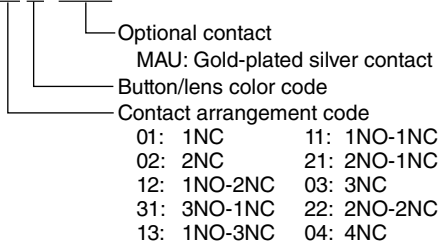

Note: Push-pull HW1B-Y2 can have a maximum of two contact blocks.

ø22 HW Series Emergency Stop Switches

Dimensions

ø29mm Pushlock Turn Reset HW1B-V3

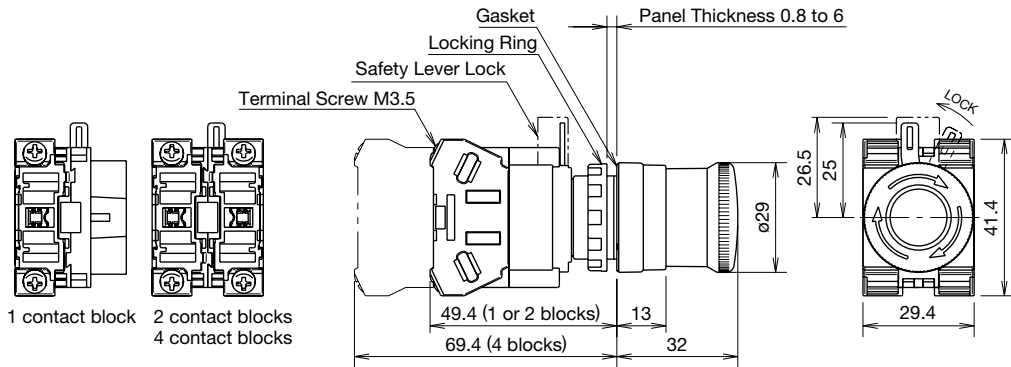

All dimensions in mm.

ø40mm Pushlock Turn Reset HW1B-V4

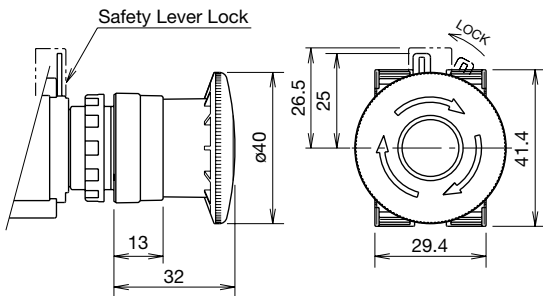

ø60mm Pushlock Turn Reset HW1B-V5

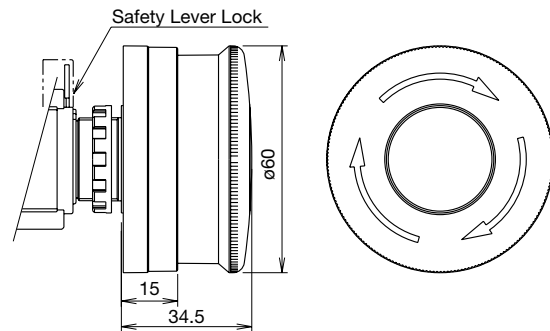

ø40mm Pushlock Key Reset HW1B-X4

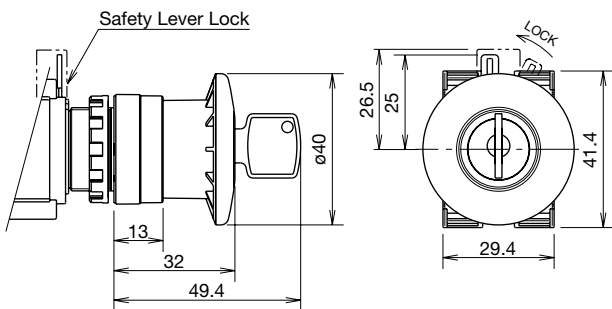

ø40mm Push-Pull HW1B-Y2

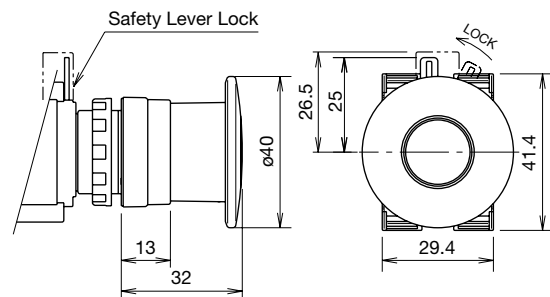

All dimensions in mm.

Panel Cut-Out

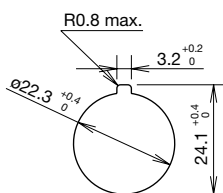

The minimum mounting centers shown below are applicable to emergency stop switches with one layer of contact blocks (two contact blocks). When two layers of contact blocks are mounted, determine the minimum mounting centers in consideration of convenience for wiring.











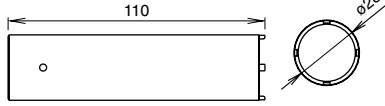

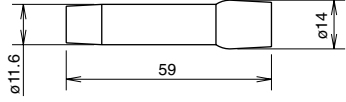
Minimum Mounting Centers for Emergency Stop Switches

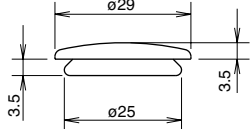
| Unit | Vertical Spacing | Horizontal Spacing |
|--|------------------|--------------------|
| HW1B-V3 HW1B-V4 HW1B-X4 HW1B-Y2 | 50 mm minimum | 50 mm minimum |
| HW1B-V5 | 60 mm minimum | 60 mm minimum |

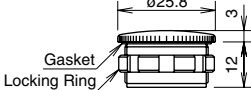
Note: When using the safety lever lock, determine the vertical spacing in consideration of convenience for installing and removing the safety lever lock. Recommended vertical spacing: 100 mm

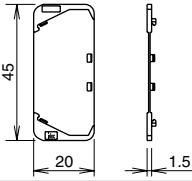
HW Series Emergency Stop Switches ø22

Accessories

| Shape | Material | Part No. | Ordering No. | Package Quantity | Description & Dimensions (mm) |
|---|---|------------------|----------------------|------------------|---|
|  | Metal (weight: approx. 150g) | MW9Z-T1 | MW9Z-T1 | 1 | <ul style="list-style-type: none"> Used to tighten the locking ring when installing the HW switch onto a panel. Tighten the locking ring to a torque of 2.0 N·m.  |
|  | Rubber | OR-55 | OR-55 | 1 | <ul style="list-style-type: none"> Used to install and remove the LED lamps.  |
|  | Rubber (black) | OB-31 | OB-31PN05 | 5 | <ul style="list-style-type: none"> Used to plug the unused ø22.2mm mounting holes.  |
|  | Diecast Metal (locking ring: plastic) | LW9Z-BM | LW9Z-BM | 1 | <ul style="list-style-type: none"> Used to plug the unused ø22.2mm mounting holes. Tighten the locking ring to a torque of 1.2 N·m. IP66 Mounting panel thickness: 0.8 to 6 mm  |
|  | Plastic | HW-VG1 | HW-VG1PN10 | 10 | <ul style="list-style-type: none"> Used to prevent contact between adjacent lead wires when units are mounted closely. Barriers should always be used in close mounting.  |
|  | Rubber | HW9Z-A25 | HW9Z-A25PN05 | 5 | <ul style="list-style-type: none"> Used to install the HW/TW units into ø25 mounting holes. IP65 Cannot be used with anti-rotation ring and nameplate. Mounting panel thickness: 1.2 to 6.0 mm |
|  | Adapter: Plastic Washer: Metal | HW9Z-A30 | HW9Z-A30PN02 | 2 | <ul style="list-style-type: none"> Used to install the HW units into ø30 mounting holes (except for HW1E and HW1B-M5/V5). IP65 Cannot be used with anti-rotation ring, nameplate, full-shroud illuminated pushbuttons, pushbutton selectors, and mono-lever switches. Mounting panel thickness: 1.6 to 4.0 mm |
|  | Adapter: Rubber Washer: Metal | HW9Z-A30E | HW9Z-A30EPN02 | 2 | <ul style="list-style-type: none"> Used to install the HW1E units into ø30 mounting holes. IP65 Cannot be used with anti-rotation ring and nameplate. Mounting panel thickness: 1.6 to 3.8 mm |

ø22 HW Series Emergency Stop Switches

Maintenance Parts

| Shape | Material | Part No. | Ordering No. | Package Quantity | Description & Dimensions (mm) |
|--|-------------------------------|--------------------|------------------------|------------------|--|
|  Safety Lever Lock | Plastic | HW9Z-LS | HW9Z-LSPN10 | 10 | <ul style="list-style-type: none"> • Yellow • 1 piece included as standard |
|  Locking Ring | Polyamide | HW9Z-LN | HW9Z-LNPN05 | 5 | <ul style="list-style-type: none"> • Black |
|  Gasket | Nitryl rubber | HW9Z-WM | HW9Z-WMPN10 | 10 | |
|  Spare Key | Metal Brass, nickel-plated | HW9Z-SK-231 | HW9Z-SK-231PN02 | 2 | <ul style="list-style-type: none"> • For pushlock key reset switches |

LED Lamps (LSTD)

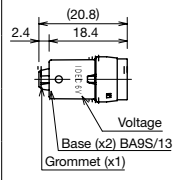
| Shape | Rated Operating Voltage | Current Draw | | Part No. | Ordering No. | Package Quantity | Base | Dimensions (mm) |
|---|-------------------------|---|---|----------------|--------------------|------------------|---------|--|
| | | AC | DC | | | | | |
|  | 6V AC/DC | 17 mA (A, R, W, Y) 8 mA (G, PW, S) | 14 mA (A, R, W, Y) 5.5 mA (G, PW, S) | LSTD-6R | LSTD-6R | 1 | BA9S/13 |  |
| | | | | | LSTD-6RPN10 | 10 | | |
| | 12V AC/DC | 11 mA | 10 mA | LSTD-1R | LSTD-1R | 1 | | |
| | | | | | LSTD-1RPN10 | 10 | | |
| | 24V AC/DC | 11 mA | 10 mA | LSTD-2R | LSTD-2R | 1 | | |
| | | | | | LSTD-2RPN10 | 10 | | |

Incandescent Lamps (LS)

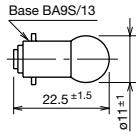
| Shape | Rated Operating Voltage | Lamp Ratings | Part No. | Package Quantity | Dimensions (mm) |
|---|-------------------------|--------------|-------------|------------------|---|
|  | 6V AC/DC | 1W (6.3V) | LS-6 | 1 |  |
| | 12V AC/DC | 1W (18V) | LS-8 | | |
| | 18V AC/DC | 1W (24V) | LS-2 | | |
| | 24V AC/DC | 1W (30V) | LS-3 | | |

HW Series Emergency Stop Switches ø22

Safety Precautions

- Turn off the power to the HW series control units before starting installation, removal, wiring, maintenance, and inspection of the products. Failure to turn power off may cause electrical shocks or fire hazard.
- To avoid a burn on your hand, use the lamp holder tool when replacing lamps.
- For wiring, use wires of a proper size to meet the voltage and current requirements. Tighten the M3.5 terminal screws to a tightening torque of 1.0 to 1.3 N·m. Failure to tighten terminal screws may cause overheating and fire.

Instructions

Panel Mounting

Remove the contact block from the operator (for transformer pilot lights, remove the transformer from the illumination unit). Remove the locking ring from the operator. Insert the operator into the panel cut-out from the front, tighten the locking ring from the back, then install the contact block to the operator.

Removing and Installing the Contact Block

1. To remove the operator from the contact block, turn the locking lever in the direction of the arrow shown below. Then the operator can be pulled out.
2. To reinstall, place the TOP markings on the operator and the contact block mounting adapter in the same direction, and insert the operator into the contact block mounting adapter. Then turn the locking lever in the opposite direction.

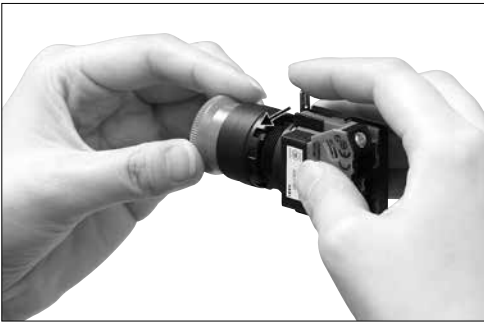

Notes for Panel Mounting

When mounting the operator onto a panel, use the optional locking ring wrench (MW9Z-T1) to tighten the locking ring. Tightening torque must not exceed 2.0 N·m. Do not use pliers. Excessive tightening will damage the locking ring.

Safety Lever Lock

IDEC strongly recommends using the safety lever lock (HW9Z-LS, yellow) to prevent heavy vibration or maintenance personnel from unlocking contacts.

1. HW series can be mounted vertically with a minimum spacing of 50 mm (70 mm for mono-lever switches) but spacing should be determined to ensure easy operation.
2. Mount the control unit onto the panel, lock the lever, and strongly push in the safety lever lock to install.
3. When the spacing is narrower than the recommended value, with the lever unlocked, mount the safety lever lock and insert the contact unit to the operator. Then, lock the lever and strongly push in the safety lever lock to install.
4. To remove the safety lever lock, insert a flat screwdriver into the safety lever lock and push upwards.

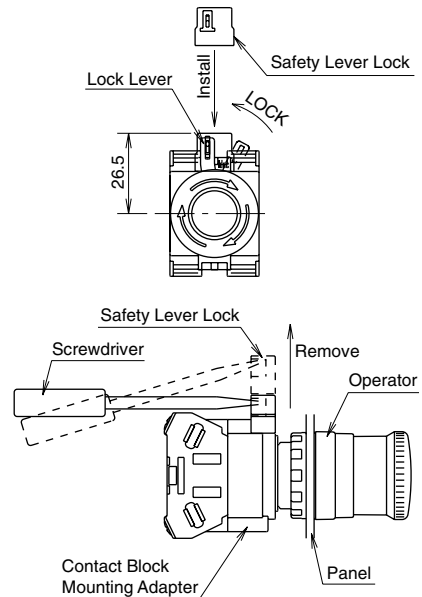

ø22 YW Series Emergency Stop Switches

Emergency Stop Switches Specifications

Standards

| Applicable Standards | Mark | File No. or Organization |
|--------------------------|------|----------------------------------|
| UL508 CSA C22.2 No.14 | | UL/c-UL Listed File No.E68961 |
| EN60947-5-5 | | TÜV SÜD |
| | | EU Low Voltage Directive |
| GB14048.5 | | CCC No. 2006010305196875 |

Specifications

| | |
|---|---|
| Operating temperature | -20 to +55°C (no freezing) |
| Operating humidity | 45 to 85% RH (no condensation) |
| Storage temperature | -45 to +80°C (no freezing) |
| Storage humidity | 95% RH maximum |
| Degree of Protection | From panel front: IP65 (IEC 60529) Terminal: IP20 (IEC 60529) |
| Insulation Resistance | 100 MΩ |
| Dielectric Strength | Contact block: 2,500V, 1 minute Pilot light: 2,000V, 1 minute |
| Vibration Resistance | Operating extremes / Damage limits: 10 to 500 Hz, amplitude 0.35 mm, acceleration 50 m/s ² |
| Shock Resistance | Operating extremes: 150 m/s ² (15G) Damage limits: 1,000 m/s ² (100G) |
| Mechanical Life (minimum operations) | 250,000 (single contact block) |
| Electrical Life (minimum operations) | 100,000 (single contact block) |

Contact Ratings (Contact Block)

| | | | | | |
|--------------------------|------------------------|------|------|-------|------|
| Rated Insulation Voltage | | 600V | | | |
| Rated Thermal Current | | 10A | | | |
| Operating Voltage | | 24V | 120V | 240V | 380V |
| AC 50/60 Hz | Resistive Load (AC-12) | 10A | 10A | 6A | 2A |
| | Inductive Load (AC-15) | 10A | 6A | 3A | 1.9A |
| DC | Resistive Load (DC-12) | 8A | 2.2A | 1.1A | — |
| | Inductive Load (DC-13) | 4A | 1.1A | 0.55A | — |

LED Lamp Ratings

| Part No. | Rated Voltage | Rated Current |
|----------|----------------|---------------|
| LSED-6R | 6V AC/DC | 10 mA |
| LSED-1R | 12V AC/DC | 14 mA |
| LSED-2R | 24V AC/DC | 14 mA |
| LSED-HR | 110/120V AC/DC | 5.5 mA |
| LSED-M3R | 230/240V AC/DC | 2.7 mA |

Incandescent Lamp Ratings

| Part No. | Rated Voltage | Ratings |
|----------|---------------|---------|
| LS-T6 | 6V AC/DC | 6.3V 1W |
| LS-T8 | 12V AC/DC | 18V 1W |
| LS-T3 | 24V AC/DC | 30V 1W |

Mounting Hole Layout

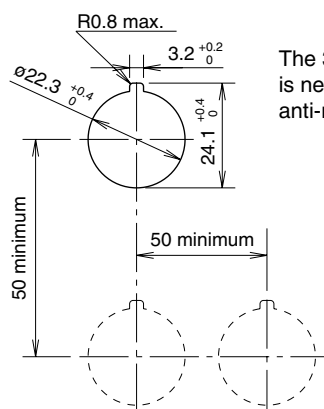

The 3.2-mm-wide key recess is necessary when the anti-rotation ring is used.

YW Series Emergency Stop Switches ø22

Pushlock Pull/Turn Reset

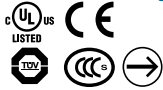
| Style | Contact | Part No. | Button Color Code |
|--|---------|--------------------|-------------------|
| ø40mm Mushroom   | 1NC | YW1B-V4E01R | Red only |
| | 2NC | YW1B-V4E02R | |
| | 3NC | YW1B-V4E03R | |
| | 1NO-1NC | YW1B-V4E11R | |
| | 1NO-2NC | YW1B-V4E12R | |
| | 2NO-1NC | YW1B-V4E21R | |

Dimensions

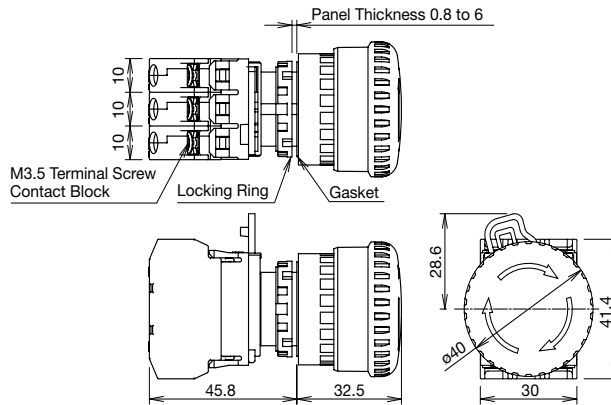

Note: When pressed, the button is locked in the depressed position, and is reset when either pulled or turned clockwise.

LED/Incandescent Illuminated Pushlock Pull/Turn Reset

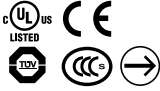
| Style | Lamp | Contacts | Part No. | ③ Operating Voltage Code | Lens Color Code |
|--|--------------|----------|----------------------|---|-----------------|
| ø40mm Mushroom   | Without Lamp | 1NC | YW1L-V4E01Q0R | 0 (without lamp) 250V AC/DC max. | Red only |
| | | 2NC | YW1L-V4E02Q0R | | |
| | | 1NO-1NC | YW1L-V4E11Q0R | | |
| | LED | 1NC | YW1L-V4E01Q③R | 2 (6V AC/DC) 3 (12V AC/DC) 4 (24V AC/DC) H (110/120V AC/DC) M3 (230/240V AC/DC) | |
| | | 2NC | YW1L-V4E02Q③R | | |
| | | 1NO-1NC | YW1L-V4E11Q③R | | |
| | Incandescent | 1NC | YW1L-V4E01Q③R | 5 (6V AC/DC) 6 (12V AC/DC) 7 (24V AC/DC) | |
| | | 2NC | YW1L-V4E02Q③R | | |
| | | 1NO-1NC | YW1L-V4E11Q③R | | |

Note: Specify an operating voltage code in place of ③ in the Part No.

Dimensions

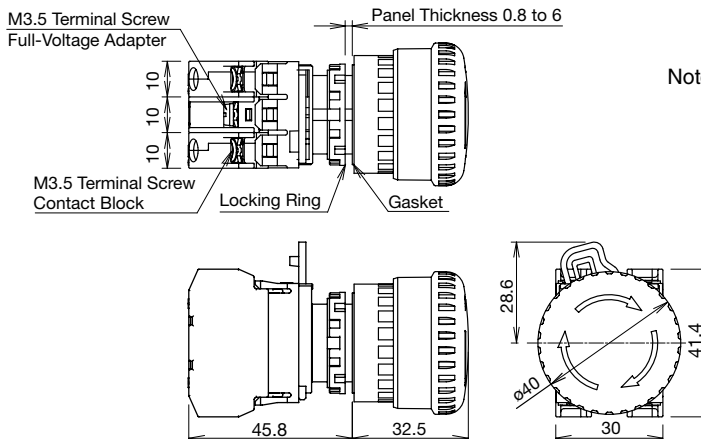









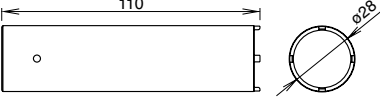

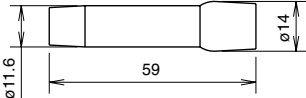
Note: When pressed, the button is locked in the depressed position, and is reset when either pulled or turned clockwise.

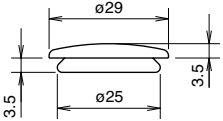
All dimensions in mm.

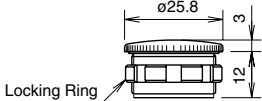

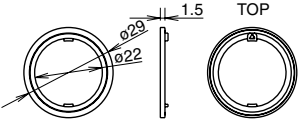

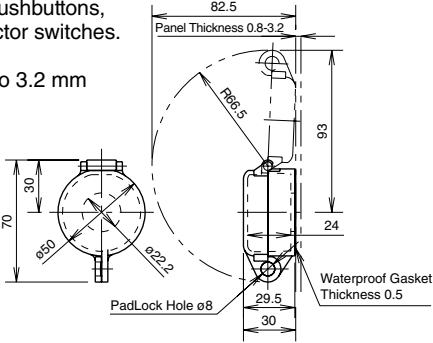
ø22 YW Series Emergency Stop Switches

Accessories

| Name & Shape | Part No. | Description & Dimensions (mm) | Package Quantity |
|---|--------------------|--|------------------|
|  | MW9Z-T1 | Metallic tool used to tighten the plastic locking ring when installing the YW series control unit on a panel.  | 1 |
|  | OR-55 | Made of rubber. Used for replacing lamps.  | 1 |
|  | OB-31PN05 | Used for plugging unused mounting holes in the panel. Color: Black  | 5 |
|  | LW9Z-BM | Used for plugging unused mounting holes in the panel. Weight: Approx. 18g  | 1 |
|  | HW9Z-RLPN10 | Prevents rotation of switches in panel. Mainly used with selector switches when no nameplate is used. With waterproof gasket (IP65). Made of plastic (black). Applicable panel thickness: 1.2 to 4.5 mm  | 10 |
|  | HW9Z-KL1 | Plastic hinged cover to protect pushbuttons, illuminated pushbuttons, or selector switches. Degree of protection: IP65. Applicable panel thickness: 0.8 to 3.2 mm  | 1 |

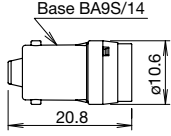
YW Series Emergency Stop Switches ø22

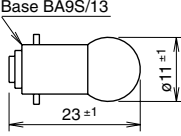
Maintenance Parts

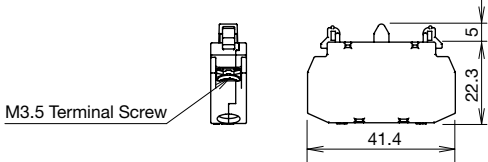
| Name & Shape | Part No. | Description & Dimensions (mm) | | Package Quantity | |
|---|-----------------|-------------------------------|---|---|-----|
|  | LSED-6R | 6V AC/DC |  | 1 | |
| | LSED-1R | 12V AC/DC | | | |
| | LSED-2R | 24V AC/DC | | | |
| | LSED-HR | 110/120V AC/DC | | | |
| | LSED-M3R | 230/240V AC/DC | | | |
|  | LS-T6P | 6.3V, 1W | One pack contains 100 incandescent lamps. |  | 100 |
| | LS-T8P | 18V, 1W | | | |
| | LS-T3P | 30V, 1W | | | |
|  | YW-E10P | Contact: 1NO |  | 10 | |
| | YW-E01P | Contact: 1NC | | | |

Nameplate (for ø22 Emergency Stop Switches)

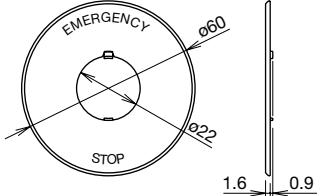
| Description | Legend | Material | Part No. | Ordering No. | Package Quantity | Dimensions (mm) |
|-------------|----------------|----------------------------------|----------------|----------------|------------------|---|
| HWAV | Blank | Plastic (yellow) 1.5 mm thick | HWAV-0 | HWAV-0 | 1 |  <p>• Legend "Emergency Stop" is indicated outside a ø44mm circle.</p> |
| | EMERGENCY STOP | | HWAV-27 | HWAV-27 | 1 | |

ø22 YW Series Emergency Stop Switches

Din Rail Mount Transformer

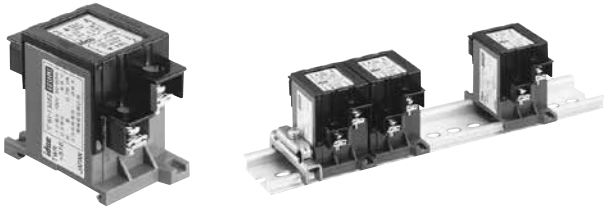

| Primary Voltage (50/60 Hz) | Part No. | Applicable Lamp Rating |
|----------------------------|----------------|---|
| 110V AC | TWR516 | One full voltage illuminated unit containing LED lamp LSED-6 (6V AC/DC) or incandescent lamp LS-T6 (6.3V) |
| 115V AC | TWR5116 | |
| 120V AC | TWR5126 | |
| 220V AC | TWR526 | |
| 230V AC | TWR5236 | |
| 240V AC | TWR5246 | |
| 380V AC | TWR5386 | |
| 440V AC | TWR546 | |
| 480V AC | TWR5486 | |

Dimensions (mm)

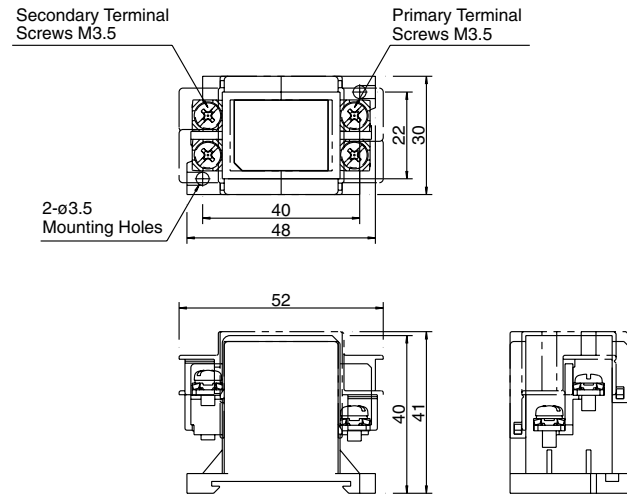

Note: Finger-safe terminal cover is supplied with the transformer.

Safety Precautions

- Turn off the power to the YW series control units before starting installation, removal, wiring, maintenance, and inspection of the products. Failure to turn power off may cause electrical shocks or fire hazard.
- To avoid burning your hand, use the lamp holder tool when replacing lamps.
- For wiring, use wires of a proper size to meet the voltage and current requirements. Tighten the M3.5 terminal screws to a tightening torque of 1.0 to 1.3 N·m. Failure to tighten the terminal screws may cause overheating and fire.

YW Series Emergency Stop Switches ø22

Instructions

Panel Mounting

- Remove the contact block from the operator. Remove the locking ring from the operator. Insert the operator into the panel cut-out from the front, tighten the locking ring from the back, then install the contact block to the operator.



① Pull up the locking lever.
② Turn the lever to the left.

③ Pull out the contact block.

Removing Contact Blocks and Full Voltage Adapter

Insert a flat screwdriver between the latch and contact block mounting adapter, and disengage the latch.



Removing and Installing the Contact Block

- To remove the operator from the contact block, pull up the locking lever and turn it to the left. Then the operator can be pulled out.
- To reinstall, place the TOP marking on the operator and the idec marking on the contact block mounting adapter in the same direction, and insert the operator into the contact block mounting adapter. Then turn the locking lever to the right.

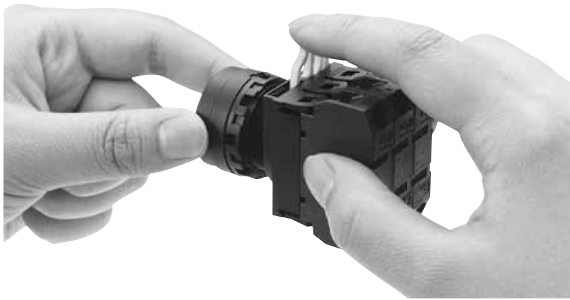

Make sure to remove the lamp and contact blocks before removing the full voltage adapter.

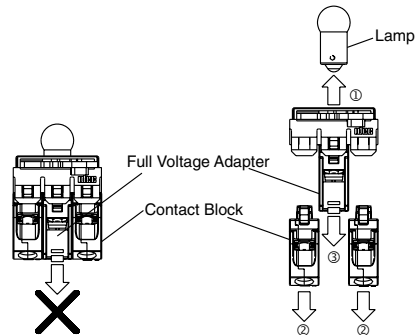

Notes for Panel Mounting

Use the optional locking ring wrench (MW9Z-T1) to mount the operator onto a panel. Tightening torque must not exceed 2.0 N·m. Do not use pliers. Excessive tightening will damage the locking ring.

ø22 YW Series Emergency Stop Switches

Instructions

Tightening Torque for Terminal Screws

Tighten terminal screws to a torque between 1.0 and 1.3 N-m.

Anti-rotation Ring and Mounting Panel

Turn the TOP marking on the operator and the ▲ mark on the anti-rotation ring to the recess on the mounting panel.

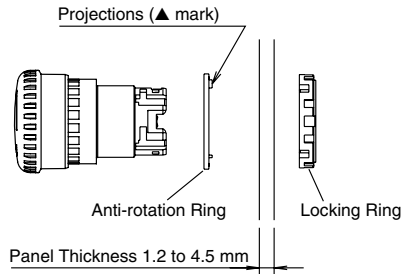

Mounting Panel Thickness

The mounting panel must be 0.8 to 6.0 mm in thickness. When optional accessories are added, the applicable panel thickness changes as shown below.

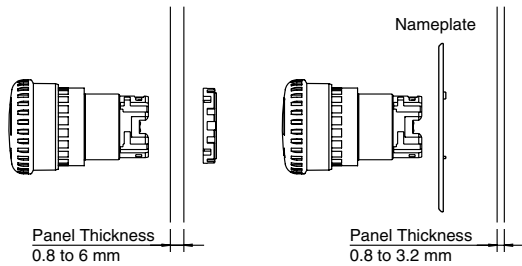

Contact Bounce

When the button is reset by pulling or turning, the NC main contacts will bounce. When pressing the button, the NO monitor contacts will bounce.

When designing a control circuit, take the contact bounce time into consideration (reference value: 20 ms).

Nameplate

When anti-rotation is not required, remove the projection from the nameplate using pliers.

Handling

Do not expose the switch to excessive shock and vibration, otherwise the switch may be deformed or damaged, causing malfunction or operation failure.

LED Illumination

LED lamps consist of semiconductors. If the applied voltage exceeds the rated voltage, LED elements deteriorate due to overheat, resulting in significant decrease in luminance, hue change, or failure of lighting. Also, if extraneous noise, transient voltage, or transient current is applied to the circuit, similar effects will be caused. When using LED lamps, observe the following instructions.

Rated Voltage

The LED illuminated units are rated at 6V, 12V, 24V, 110V, or 230/240V AC/DC, and can be used within $\pm 10\%$ the rated voltage of either AC or DC, except the 230/240V AC/DC can be used on 250V AC/DC maximum.

DC Power

1. Switching power supply

Regulated voltage from switching power supply is best suited. Make sure to use within the rated voltage of the LED lamp.

2. Rechargeable battery

Note that the battery voltage may exceed the rated voltage of the LED lamp while the battery is being charged and immediately after the charging is complete. Be sure to use the LED lamp on a voltage of $\pm 10\%$ the rated voltage, except the 230/240V AC/DC on 250V AC/DC maximum.

3. Full-wave rectification

Since the LED lamp is AC/DC compatible, a diode bridge for rectification is not necessary. If the LED lamp is used on a full-wave rectification current through a diode bridge, the rectifier diodes will reduce the voltage, resulting in lower luminance.

4. Single-phase half-wave rectification

This is not suitable for the power source of LED lamps. Use constant-voltage DC power.

Noise

LED elements deteriorate due to extraneous noise, resulting in significant decrease in luminance, hue change, or failure of lighting. When such effects are anticipated, take a protection measure shown below, such as RC elements or a surge absorber.

[Protection Example 1] For AC circuit

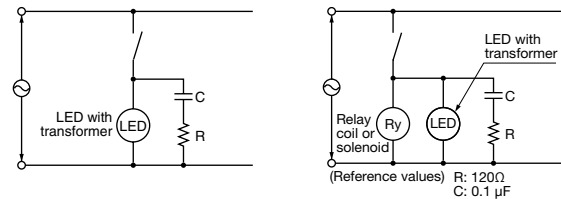

[Protection Example 2] For DC circuit

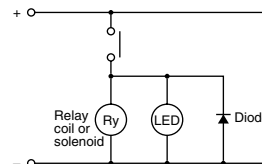

Countermeasures against Dim Lighting

1. Leakage currents through the transistors or a contact protection circuit may cause the LED lamp to illuminate dimly even when the output is off.
2. When the LED lamp is illuminated by a transistor output, take the following measure.

[Circuit Example]

Connect shunt resistor R in parallel with the LED lamp.

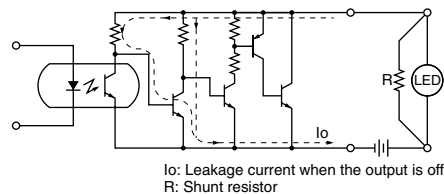

I₀: Leakage current when the output is off
R: Shunt resistor

Ordering Information

- When ordering, specify the Part No. and quantity.
- Replacement contact blocks are supplied in a package containing 10 pieces.

ø30 XN series Emergency Stop Switches

ø30 mm, 4-contact Emergency Stop Switch. Padlockable and flush bezel are available.

- Padlockable, flush bezel, ø60mm jumbo mushroom, illuminated, LED push-on are available.
- IDEC's original "Safe break action" and reverse energy structure ensure the highest level of safety.
- Safety lock mechanism (IEC 60947-5-5, 6.2)
- Direct opening action mechanism (IEC 60947-5-5, 5.2, IEC60947-5-1, Annex K)
- Short depth behind the panel – only 47.7 mm for 4-contact, illuminated (flush bezel: 60.4 mm, padlockable: 61.4 mm)
- Padlockable can be locked using padlocks when latched (main contact: OFF). The rugged aluminum diecast shroud allows for installing a maximum of 20 padlocks using a hasp (total weight: 1500g maximum).
- Gold-plated silver contacts.
- Red (Munsell 5R4/12) or bright red (Munsell 7.5R4.5/14) colors are available.



Standards

| Applicable Standards | Mark | File No. or Organization |
|---------------------------------|------|-----------------------------|
| UL508 CSA C22.2 No. 14 | | UL/c-UL File No. E68961 |
| IEC60947-5-5 UL991 NFPA79 | | UL Listing File No. E305148 |
| EN60947-5-5 | | TÜV SÜD |
| | | EU Low Voltage Directive |
| GB14048.5 | | CCC No. 2008010305290010 |

Contact Ratings

NC main contacts/NO monitor contacts

| | | | | | | |
|-------------------------------|------------------|------------------------|------------------------|-------|-------|------|
| Rated Insulation Voltage (Ui) | | 250V | | | | |
| Rated Thermal Current (Ith) | | 5A | | | | |
| Rated Operating Voltage (Ue) | | 30V | 125V | 250V | | |
| Rated Operating Current | Main Contacts | AC 50/60 Hz | Resistive Load (AC-12) | – | 5A | 3A |
| | | | Inductive Load (AC-15) | – | 3A | 1.5A |
| | | DC | Resistive Load (DC-12) | 2A | 0.4A | 0.2A |
| | | | Inductive Load (DC-13) | 1A | 0.22A | 0.1A |
| | Monitor Contacts | AC 50/60 Hz | Resistive Load (AC-12) | – | 1.2A | 0.6A |
| | | | Inductive Load (AC-14) | – | 0.6A | 0.3A |
| DC | | Resistive Load (DC-12) | 2A | 0.4A | 0.2A | |
| | | Inductive Load (DC-13) | 1A | 0.22A | 0.1A | |
| Contact Material | | Gold-plated Silver | | | | |

- Minimum applicable load: 5V AC/DC, 1 mA (reference value) (May vary depending on the operating conditions and load types.)
- The rated operating currents are measured at resistive/inductive load types specified in IEC 60947-5-1.

Illumination Ratings (LED)

| Rated Voltage | Operating Voltage | Rated Current |
|---------------|-------------------|---------------|
| 24V AC/DC | 24V AC/DC ±10% | 15 mA |



Specifications

| | |
|--|---|
| Applicable Standards | IEC60947-5-1, EN60947-5-1 IEC60947-5-5, EN60947-5-5 JIS C8201-5-1, UL508, UL991, NFPA79 CSA C22.2 No. 14, GB14048.5 |
| Operating Temperature | Non-illuminated: –25 to +60°C (no freezing) Illuminated: –25 to +55°C (no freezing) |
| Storage Temperature | –45 to +80°C |
| Operating Humidity | 45 to 85% RH (no condensation) |
| Minimum Force Required for Direct Opening Action | 80N |
| Minimum Operator Stroke Required for Direct Opening Action | 4.0 mm |
| Maximum Operator Stroke | 4.5 mm |
| Contact Resistance | 50 mΩ maximum (initial value) |
| Insulation Resistance | 100 MΩ minimum (500V DC megger) |
| Overvoltage Category | II |
| Impulse Withstand Voltage | 2.5 kV |
| Pollution Degree | 3 |
| Operating Frequency | 900 operations/hour |
| Shock Resistance | Operating extremes: 150 m/s ² Damage limits: 1000 m/s ² |
| Vibration Resistance | Operating extremes: 10 to 500 Hz, amplitude 0.35 mm, acceleration 50 m/s ² Damage limits: 10 to 500 Hz, amplitude 0.35 mm, acceleration 50 m/s ² |
| Durability (at 900 operations/h, on-duration 40%) | Mechanical: 250,000 operations minimum Electrical: 100,000 operations minimum 250,000 operations minimum (24V AC/DC, 100 mA) |
| Degree of Protection | Operator: IP65 (IEC60529) Terminal: IP20 (when XW9Z-VL2MF is installed) |
| Short-circuit Protection | 250V/10A fuse (Type aM, IEC60269-1/IEC60269-2) |
| Conditional Short-circuit Current | 1000A |
| Terminal Style | M3 screw terminal |
| Recommended Tightening Torque for Terminal Screw | 0.6 to 1.0 N·m |
| Recommended Tightening Torque for Locking Ring | 2.5 N·m |
| Applicable Wire Size | 0.75 to 1.25 mm ² (AWG18 to 16) |
| Total Weight of a Hasp and Padlocks | 1500g maximum (padlockable) |
| Reinforced Insulation (IEC 60664-1) | Between live part and metal bezel (flush bezel, padlockable) |
| Weight | 83g (XN1E-LV404Q4MR) 93g (XN1E-BV504MR) 89g (XN5E-LV404Q4MR) 120g (XN4E-LL404Q4MR) |

ø30 XN Series Emergency Stop Switches

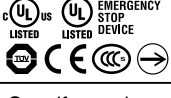

Plastic Bezel

Non-illuminated Pushlock Pull/Turn Reset (Solder Terminal)

| Shape | NC Main Contact | NO Monitor Contact | Part No. | | ① Operator Color Code |
|--|-----------------|--------------------|--------------------------|----------------------|--------------------------|
| | | | IP20 Fingersafe Terminal | w/Terminal Cover | |
|   | 1NC | — | XN1E-BV401MF ① | XN1E-BV401M ① | R: Red RH: Bright red |
| | 2NC | — | XN1E-BV402MF ① | XN1E-BV402M ① | |
| | 3NC | — | XN1E-BV403MF ① | XN1E-BV403M ① | |
| | 4NC | — | XN1E-BV404MF ① | XN1E-BV404M ① | |
| | 1NC | 1NO | XN1E-BV411MF ① | XN1E-BV411M ① | |
| | 2NC | 1NO | XN1E-BV412MF ① | XN1E-BV412M ① | |
| | 3NC | 1NO | XN1E-BV413MF ① | XN1E-BV413M ① | |
| | 2NC | 2NO | XN1E-BV422MF ① | XN1E-BV422M ① | |
|   | 1NC | — | XN1E-BV501MF ① | XN1E-BV501M ① | |
| | 2NC | — | XN1E-BV502MF ① | XN1E-BV502M ① | |
| | 3NC | — | XN1E-BV503MF ① | XN1E-BV503M ① | |
| | 4NC | — | XN1E-BV504MF ① | XN1E-BV504M ① | |
| | 1NC | 1NO | XN1E-BV511MF ① | XN1E-BV511M ① | |
| | 2NC | 1NO | XN1E-BV512MF ① | XN1E-BV512M ① | |
| | 3NC | 1NO | XN1E-BV513MF ① | XN1E-BV513M ① | |
| | 2NC | 2NO | XN1E-BV522MF ① | XN1E-BV522M ① | |



- Specify a color code in place of ① in the Part No.
- Only solid wires can be used on the IP20 fingersafe terminal switches.

Illuminated Pushlock Pull/Turn Reset (Solder Terminal)

| Shape | Illumination | Rated Voltage | NC Main Contact | NO Monitor Contact | Part No. | | Operator Color |
|--|--------------|---------------|-----------------|--------------------|--------------------------|-----------------------|----------------|
| | | | | | IP20 Fingersafe Terminal | w/Terminal Cover | |
|   | LED | 24V AC/DC | 1NC | — | XN1E-LV401Q4MFR | XN1E-LV401Q4MR | Red only |
| | | | 2NC | — | XN1E-LV402Q4MFR | XN1E-LV402Q4MR | |
| | | | 3NC | — | XN1E-LV403Q4MFR | XN1E-LV403Q4MR | |
| | | | 4NC | — | XN1E-LV404Q4MFR | XN1E-LV404Q4MR | |
| | | | 1NC | 1NO | XN1E-LV411Q4MFR | XN1E-LV411Q4MR | |
| | | | 2NC | 1NO | XN1E-LV412Q4MFR | XN1E-LV412Q4MR | |
| | | | 3NC | 1NO | XN1E-LV413Q4MFR | XN1E-LV413Q4MR | |
| | | | 2NC | 2NO | XN1E-LV422Q4MFR | XN1E-LV422Q4MR | |

- Only solid wires can be used on the IP20 fingersafe terminal switches.

Illuminated Push-ON Pushlock Pull/Turn Reset (Solder Terminal)







| Shape | Illumination | Rated Voltage | NC Main Contact | NO Monitor Contact | Part No. | | Operator Color |
|--|--------------|---------------|-----------------|--------------------|--------------------------|-----------------------|----------------|
| | | | | | IP20 Fingersafe Terminal | w/Terminal Cover | |
|   | LED | 24V AC/DC | 2NC | — | XN1E-TV402Q4MFR | XN1E-TV402Q4MR | Red only |
| | | | 3NC | — | XN1E-TV403Q4MFR | XN1E-TV403Q4MR | |
| | | | 2NC | 1NO | XN1E-TV412Q4MFR | XN1E-TV412Q4MR | |

- Push-ON is illuminated when the operator is latched, and turns off when reset.
- Only solid wires can be used on the IP20 fingersafe terminal switches.

XN series Emergency Stop Switches ø30







Flush Bezel

Non-illuminated Pushlock Pull/Turn Reset (Solder Terminal)

| Shape | NC Main Contact | NO Monitor Contact | Part No. | | Operator Color Code |
|--|-----------------|--------------------|--------------------------|----------------------|--------------------------|
| | | | IP20 Fingersafe Terminal | w/Terminal Cover | |
|       | 1NC | — | XN5E-BV401MF ① | XN5E-BV401M ① | R: Red RH: Bright red |
| | 2NC | — | XN5E-BV402MF ① | XN5E-BV402M ① | |
| | 3NC | — | XN5E-BV403MF ① | XN5E-BV403M ① | |
| | 4NC | — | XN5E-BV404MF ① | XN5E-BV404M ① | |
| | 1NC | 1NO | XN5E-BV411MF ① | XN5E-BV411M ① | |
| | 2NC | 1NO | XN5E-BV412MF ① | XN5E-BV412M ① | |
| | 3NC | 1NO | XN5E-BV413MF ① | XN5E-BV413M ① | |
| | 2NC | 2NO | XN5E-BV422MF ① | XN5E-BV422M ① | |







- Specify a color code in place of ① in the Part No.
- Only solid wires can be used on the IP20 fingersafe terminal switches.

Illuminated Pushlock Pull/Turn Reset (Solder Terminal)

| Shape | Illumination | Rated Voltage | NC Main Contact | NO Monitor Contact | Part No. | | Operator Color |
|--|--------------|---------------|-----------------|--------------------|--------------------------|-----------------------|----------------|
| | | | | | IP20 Fingersafe Terminal | w/Terminal Cover | |
|       | LED | 24V AC/DC | 1NC | — | XN5E-LV401Q4MFR | XN5E-LV401Q4MR | Red only |
| | | | 2NC | — | XN5E-LV402Q4MFR | XN5E-LV402Q4MR | |
| | | | 3NC | — | XN5E-LV403Q4MFR | XN5E-LV403Q4MR | |
| | | | 4NC | — | XN5E-LV404Q4MFR | XN5E-LV404Q4MR | |
| | | | 1NC | 1NO | XN5E-LV411Q4MFR | XN5E-LV411Q4MR | |
| | | | 2NC | 1NO | XN5E-LV412Q4MFR | XN5E-LV412Q4MR | |
| | | | 3NC | 1NO | XN5E-LV413Q4MFR | XN5E-LV413Q4MR | |
| | | | 2NC | 2NO | XN5E-LV422Q4MFR | XN5E-LV422Q4MR | |

- Only solid wires can be used on the IP20 fingersafe terminal switches.

Illuminated Push-ON Pushlock Pull/Turn Reset (Solder Terminal)



| Shape | Illumination | Rated Voltage | NC Main Contact | NO Monitor Contact | Part No. | | Operator Color |
|--|--------------|---------------|-----------------|--------------------|--------------------------|-----------------------|----------------|
| | | | | | IP20 Fingersafe Terminal | w/Terminal Cover | |
|       | LED | 24V AC/DC | 2NC | — | XN5E-TV402Q4MFR | XN5E-TV402Q4MR | Red only |
| | | | 3NC | — | XN5E-TV403Q4MFR | XN5E-TV403Q4MR | |
| | | | 2NC | 1NO | XN5E-TV412Q4MFR | XN5E-TV412Q4MR | |

- Push-ON is illuminated when the operator is latched, and turns off when reset.
- Only solid wires can be used on the IP20 fingersafe terminal switches.

ø30 XN Series Emergency Stop Switches



Padlockable

Non-illuminated Pushlock Turn Reset (Padlockable)

| Shape | NC Main Contact | NO Monitor Contact | Part No. | | Operator Color |
|--|-----------------|--------------------|--------------------------|----------------------|-----------------|
| | | | IP20 Fingersafe Terminal | w/Terminal Cover | |
|    | 1NC | — | XN4E-BL401MFRH | XN4E-BL401MRH | Bright red only |
| | 2NC | — | XN4E-BL402MFRH | XN4E-BL402MRH | |
| | 3NC | — | XN4E-BL403MFRH | XN4E-BL403MRH | |
| | 4NC | — | XN4E-BL404MFRH | XN4E-BL404MRH | |
| | 1NC | 1NO | XN4E-BL411MFRH | XN4E-BL411MRH | |
| | 2NC | 1NO | XN4E-BL412MFRH | XN4E-BL412MRH | |
| | 3NC | 1NO | XN4E-BL413MFRH | XN4E-BL413MRH | |
| | 2NC | 2NO | XN4E-BL422MFRH | XN4E-BL422MRH | |



- Only solid wires can be used on the IP20 fingersafe terminal switches.
- Padlocks and hasps are not supplied with the emergency stop switches and must be ordered separately. See page 53.

Illuminated Pushlock Turn Reset (Padlockable)

| Shape | Illumination | Rated Voltage | NC Main Contact | NO Monitor Contact | Part No. | | Operator Color |
|--|--------------|---------------|-----------------|--------------------|--------------------------|-----------------------|----------------|
| | | | | | IP20 Fingersafe Terminal | w/Terminal Cover | |
|    | LED | 24V AC/DC | 1NC | — | XN4E-LL401Q4MFR | XN4E-LL401Q4MR | Red only |
| | | | 2NC | — | XN4E-LL402Q4MFR | XN4E-LL402Q4MR | |
| | | | 3NC | — | XN4E-LL403Q4MFR | XN4E-LL403Q4MR | |
| | | | 4NC | — | XN4E-LL404Q4MFR | XN4E-LL404Q4MR | |
| | | | 1NC | 1NO | XN4E-LL411Q4MFR | XN4E-LL411Q4MR | |
| | | | 2NC | 1NO | XN4E-LL412Q4MFR | XN4E-LL412Q4MR | |
| | | | 3NC | 1NO | XN4E-LL413Q4MFR | XN4E-LL413Q4MR | |
| | | | 2NC | 2NO | XN4E-LL422Q4MFR | XN4E-LL422Q4MR | |

- Only solid wires can be used on the IP20 fingersafe terminal switches.
- Padlocks and hasps are not supplied with the emergency stop switches and must be ordered separately. See page 53.

LED Push-ON Pushlock Turn Reset (Padlockable)

| Shape | Illumination | Rated Voltage | NC Main Contact | NO Monitor Contact | Part No. | | Operator Color |
|--|--------------|---------------|-----------------|--------------------|--------------------------|-----------------------|----------------|
| | | | | | IP20 Fingersafe Terminal | w/Terminal Cover | |
|    | LED | 24V AC/DC | 2NC | — | XN4E-TL402Q4MFR | XN4E-TL402Q4MR | Red only |
| | | | 3NC | — | XN4E-TL403Q4MFR | XN4E-TL403Q4MR | |
| | | | 2NC | 1NO | XN4E-TL412Q4MFR | XN4E-TL412Q4MR | |

- Push-ON is illuminated when the operator is latched, and turns off when reset.
- Only solid wires can be used on the IP20 fingersafe terminal switches.
- Padlocks and hasps are not supplied with the emergency stop switches and must be ordered separately. See page 53.

XN Series Emergency Stop Switches ø30

Dimensions

Plastic Bezel
Non-illuminated
IP20 Fingersafe

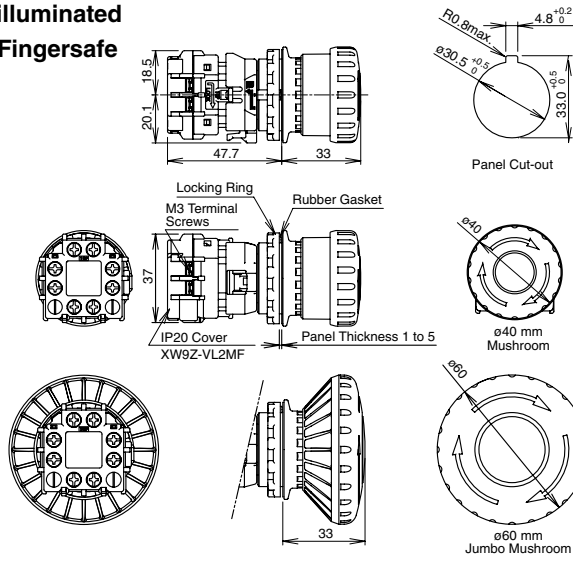

w/Terminal Cover

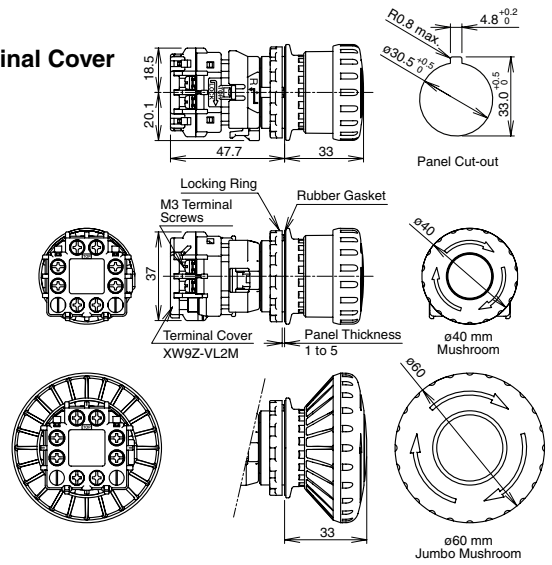

Illuminated/Push-ON
IP20 Fingersafe

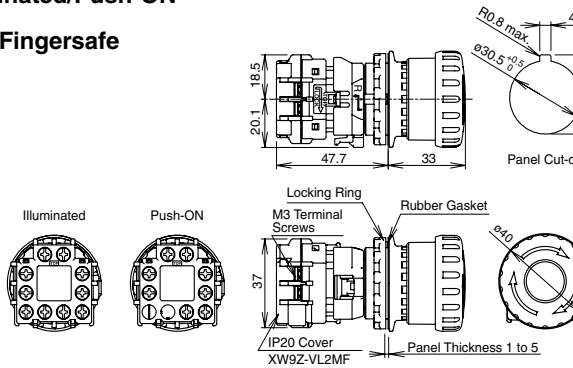

w/Terminal Cover

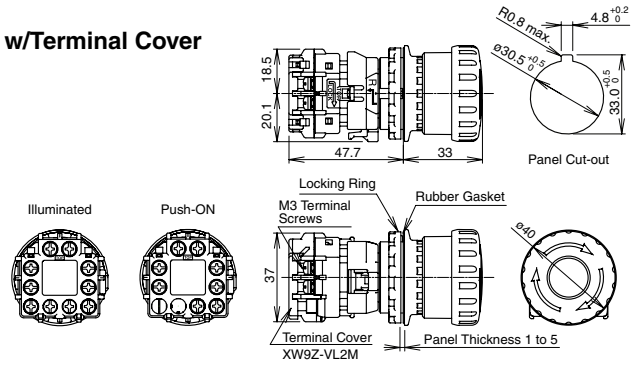

Flush Bezel
Non-Illuminated
IP20 Fingersafe

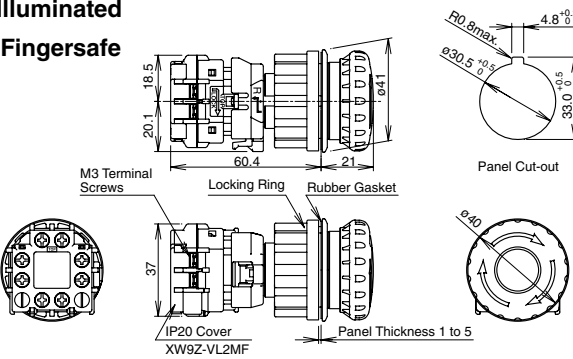

w/Terminal Cover

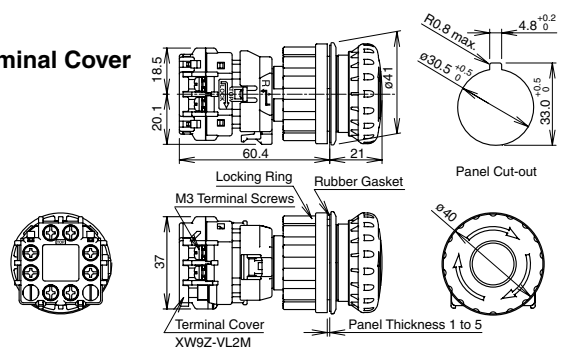

Illuminated/Push-ON
IP20 Fingersafe

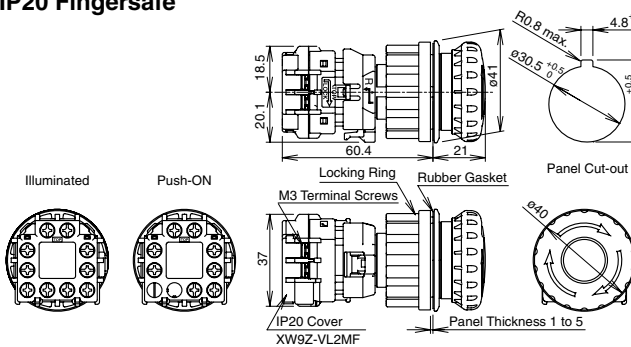

w/Terminal Cover

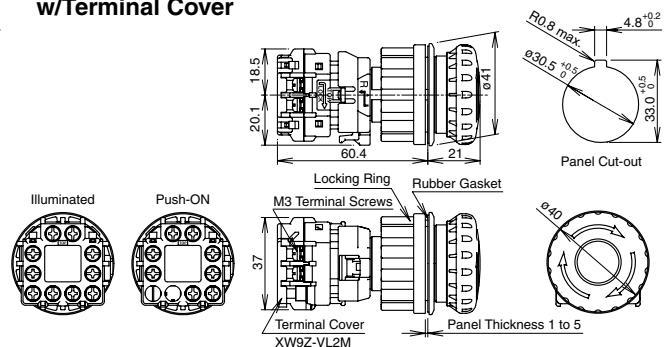

All dimensions in mm.

ø30 XN Series Emergency Stop Switches

Dimensions

Padlockable
Non-illuminated
IP20 Fingersafe

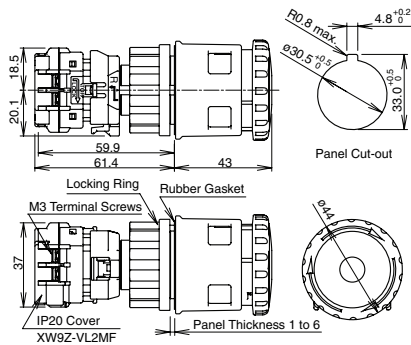

w/ Terminal Cover

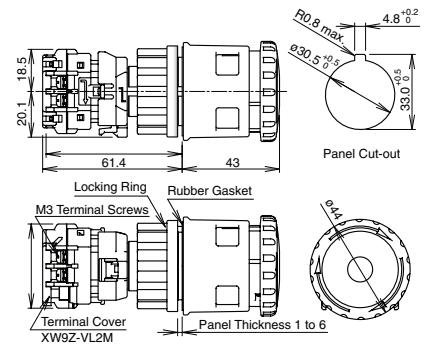

illuminated/push-on

IP20 Fingersafe

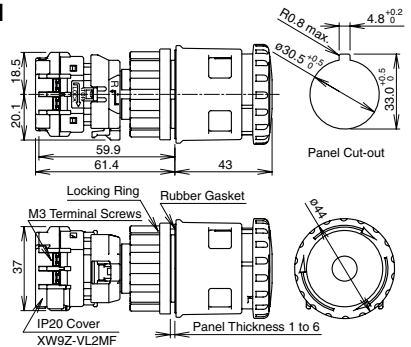

w/ Terminal Cover

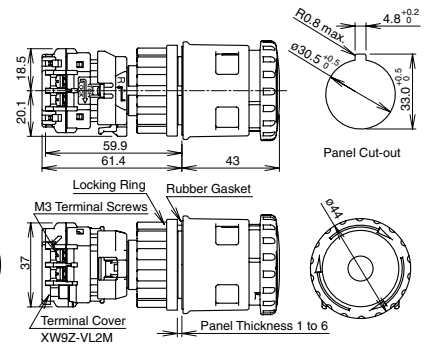

Mounting Hole Layout

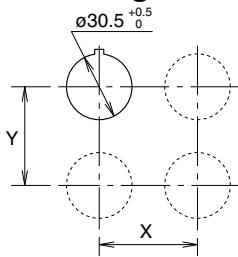

| | X | Y |
|---------------|---------------|---|
| Plastic Bezel | 70 mm minimum | |
| Flush Bezel | 70 mm minimum | |

- The values shown above are the minimum dimensions for mounting with other ø30 mm pushbuttons. For other control units of different sizes and styles, determine the values according to the dimensions, operation, and wiring convenience.
- For padlockable, determine the values according to the size and number of padlocks and hasp.

LED Unit Internal Circuit

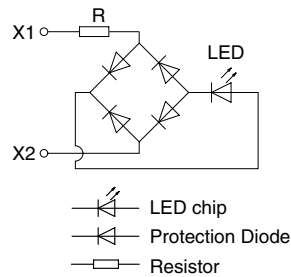

Terminal Arrangement (Bottom View)

Non-illuminated

NC main contacts only

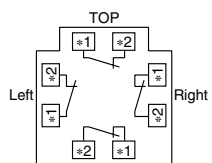

- 1NC: Terminals on right
- 2NC: Terminals on right and left
- 3NC: Terminals on right, left, and top

With 1NO monitor contact

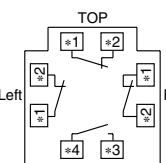

- 1NC: Terminals on top
- 2NC: Terminals on right and left

With 2NO monitor contacts

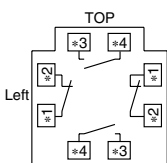

illuminated

NC main contacts only

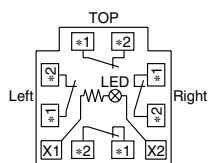

- 1NC: Terminals on right
- 2NC: Terminals on right and left
- 3NC: Terminals on right, left, and top

With 1NO monitor contact

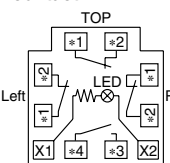

- 1NC: Terminals on top
- 2NC: Terminals on right and left

With 2NO monitor contacts

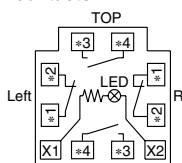

Push-ON

NC main contacts only

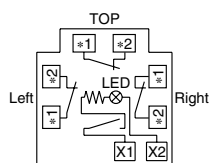

- 2NC: Terminals on right and left
- 3NC: Terminals on right, left, and top

With 1NO monitor contact

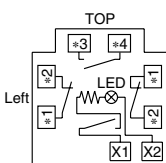

- Contact
- 1-2: NC main contact (black)
- 3-4: NO monitor contact (blue)
- Contact Number (1-4) Starting with the contact of TOP side, in a counter-clockwise direction.

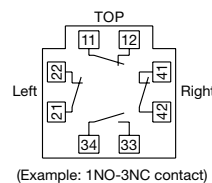

(Example: 1NO-3NC contact)

Applicable Crimping Terminal

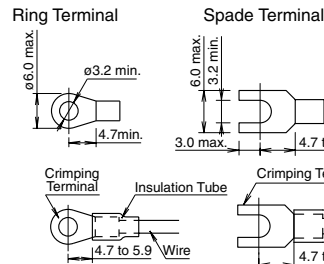

Solid Wire

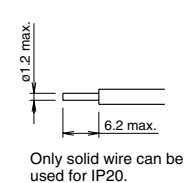





- Be sure to install an insulating tube on the crimping terminal.

All dimensions in mm.

XN Series Emergency Stop Switches ø30

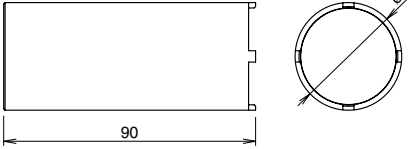
Accessories and Replacement Parts

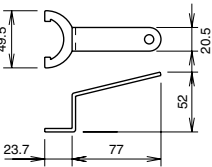
| Name & Shape | Material | Part No. | Ordering No. | Package Quantity | Remarks |
|--|----------------------------------|------------|----------------|------------------|--|
|  | PPE | XW9Z-VL2M | XW9Z-VL2MPN02 | 2 | <ul style="list-style-type: none"> Black Used for screw terminals. Attached to IP20 protection cover units. |
|  | Polyamide | XW9Z-VL2MF | XW9Z-VL2MFPN02 | 2 | <ul style="list-style-type: none"> Black Used to change terminal cover to IP20 fingersafe terminal. Only solid wires can be used. Once installed, IP20 terminal cover cannot be removed. |
|  | Brass | XN9Z-T1 | XN9Z-T1 | 1 | <ul style="list-style-type: none"> Used to tighten the locking ring when installing the XN emergency stop switch onto a panel.  |
|  | Steel Trivalent chromate plating | TWST-T1 | TWST-T1 | 1 | <ul style="list-style-type: none"> Used to tighten the locking ring when installing the XN emergency stop switch onto a panel.  |

- The XN series emergency stop switches are supplied with either terminal cover or IP20 fingersafe terminal cover.
- Padlocks and hasps are not supplied and must be ordered separately.

Nameplates (for ø30 Emergency Stop Switches)

| Description & Shape | Legend | Part No. | Package Quantity | Dimensions (mm) |
|---|----------------|----------|------------------|--|
|  | (blank) | HNAV-0 | 1 | Polyamide Mounting panel thickness XN4E-□L4: 1.0 to 4.5 mm XN□E-□V4: 1.0 to 3.5 mm  |
| | EMERGENCY STOP | HNAV-27 | | |

Plate color: Yellow (Munsell 2.5Y 8/10 or equivalent),
Legend: Black

Padlock and Hasp

Padlocks and hasps of the following specifications can be used with padlockable emergency stop switches.

Padlock Size

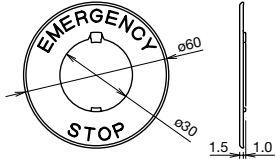
| a | b | c | d |
|--------------|---------------|---------------|----------------------|
| 7 mm maximum | 19 mm minimum | 39 mm minimum | 15 mm minimum (Note) |

Note: When the padlock is installed from the side of the bezel, dimension d requires a minimum of 6 mm. When the padlock is installed from the front of the button, dimension d requires a minimum of 15 mm.

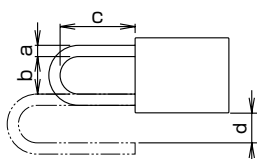

Recommended Hasp

| Maker | Part No. |
|--------------------------|-------------------|
| PANDUIT CORP. | PSL-HD3 PSL-1A |
| Master Lock® Company LLC | 420, 421 |

Use only padlocks or hasps that satisfy the specifications shown on the left. The maximum total weight for padlocks and hasps is 1500g.

Make sure that the total weight does not exceed 1500g, otherwise the XN emergency stop switch may be damaged. Make sure that locking and unlocking of the padlock and hasp do not interfere with other devices.

Padlocks and hasps are available from the following manufacturers.

| Manufacturer | URL |
|--------------------------|---|
| PANDUIT CORP. | http://www.panduit.com/ |
| Master Lock® Company LLC | http://www.masterlock.com/ |

Operating Instructions

Removing the Contact Block

First unlock the operator button. Grab the yellow bayonet ring ① and pull back the bayonet ring until the latch pin clicks ②, then turn the contact block counterclockwise and pull out ③.

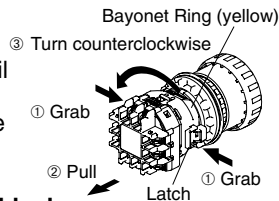

Notes for removing the contact block

1. Do not attempt to remove the contact block while the operator is latched, otherwise the switch may be damaged.
2. When the contact block is removed, the monitor contact (NO contact) is closed.
3. While removing the contact block, do not use excessive force, otherwise the switch may be damaged.
4. An LED lamp is built into the contact block for illuminated pushbuttons. When removing the contact block, pull the contact block straight to prevent damage to the LED lamp. If excessive force is used, the LED lamp may be damaged and fail to light.

Panel Mounting

Remove the locking ring from the operator and check that the rubber gasket is in place. Insert the operator from panel front into the panel hole. Face the side without thread on the operator with TOP marking upward, and tighten the locking ring using ring wrench XN9Z-T1 or TWST-T1 to a torque of 2.5 N·m maximum.

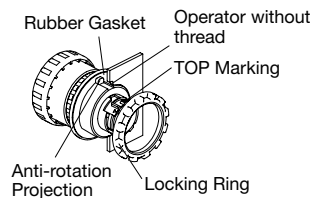

When using a nameplate

When using a nameplate HNAV-□, break the projection from the nameplate using pliers.

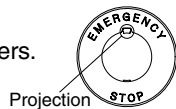

Installing the Contact Block

First unlock the operator button. Align the small ▼ marking on the edge of the operator with the small ▲ marking on the yellow bayonet ring. Hold the contact block, not the bayonet ring. Press the contact block onto the operator and turn the contact block clockwise until the bayonet ring clicks.

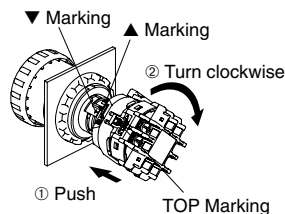

Notes for installing the contact block

1. Do not attempt to install the contact block when the operator is latched, otherwise the switch may be damaged.
2. Make sure that the bayonet ring is in the locked position.

Installing & Removing Terminal Covers

XW9Z-VL2M

To install the terminal cover, align the TOP marking on the terminal cover with the TOP marking on the contact block. Place the two projections on the bottom side of the contact block into the slots in the terminal cover. Press the terminal cover toward the contact block.

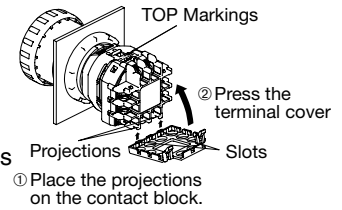

To remove the terminal cover, pull out the two latches on the top side of the terminal cover. Do not exert excessive force to the latches, otherwise the latches may break.

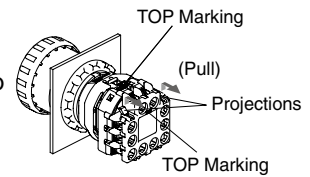

IP20 Fingersafe Terminal Cover XW9Z-VL2MF

To install the IP20 fingersafe terminal cover, align the TOP marking on the cover with the TOP marking on the contact block, and press the cover toward the contact block.

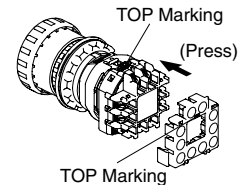

Notes:

1. Once installed, the XW9Z-VL2MF cannot be removed.
2. With the XW9Z-VL2MF installed, crimping terminals cannot be used. Use solid wires.
3. The XW9Z-VL2MF cannot be installed after wiring.
4. Make sure that the XW9Z-VL2MF is securely installed. IP20 cannot be achieved when installed loosely, and electric shocks may occur.

Notes for Operation

When using the XN emergency stop switches in safety-related part of a control system, observe safety standards and regulations of the relevant country or region. Also be sure to perform a risk assessment before operation.

Wiring

Tighten the M3 terminal screws to a torque of 0.6 to 1.0 N·m.

Contact Bounce

When the button is reset by pulling or turning, the NC main contacts will bounce. When pressing the button, the NO monitor contacts will bounce. When designing a control circuit, take the contact bounce time into consideration (reference value: 20 ms).

LED Illuminated Switches

An LED lamp is built into the contact block and cannot be replaced.

Handling

Do not expose the switch to excessive shocks and vibrations, for example by operating the switch with tools. Otherwise the switch may be deformed or damaged, causing malfunction or operation failure.

ø30 HN Series Emergency Stop Switches

Emergency Stop Switches (Unibody) Specifications

Standards

| Applicable Standards | Mark | File No. or Organization |
|---------------------------|------|----------------------------|
| UL508 CSA C22.2 No. 14 | | UL Listing File No. E55996 |
| EN60947-5-5 | | TÜV SÜD |
| | | EU Low Voltage Directive |
| GB14048.5 | | CCC No. 2013010305610376 |

Contact Ratings

| | | | | | |
|--------------------------------|-------------|------------------------|------|------|-------|
| Rated Insulation Voltage (Ui) | | 250V | | | |
| Rated Thermal Current (Ith) | | 10A | | | |
| Rated Operational Voltage (Ue) | | 24V | 110V | 220V | |
| Rated Operational Current | AC 50/60 Hz | Resistive Load (AC-12) | 6A | 3A | 3A |
| | | Inductive Load (AC-15) | 6A | 3A | 3A |
| | DC | Resistive Load (DC-12) | 6A | 2A | 1A |
| | | Inductive Load (DC-13) | 1.5A | 0.3A | 0.15A |

Note: The operational current represents the classification by making and breaking currents (IEC 60947-5-1).
Minimum applicable load (reference value): 3V AC/DC, 5 mA (Applicable range may vary with operating conditions and load types.)

LED Lamp Ratings

| Rated Operating Voltage of Unit | LED Lamp | | |
|---------------------------------|----------|----------------|---------------|
| | Part No. | Rated Voltage | Rated Current |
| 24V AC/DC | LSTD-2R | 24V AC/DC ±10% | 10 mA |



Incandescent Lamp Ratings

| Unit Rated Operating Voltage | Incandescent Lamp | |
|------------------------------|-------------------|----------|
| | Part No. | Wattage |
| 24V AC/DC | LS-3 | 1W (30V) |

Specifications



| | |
|--|--|
| Operating Temperature | -25 to +60°C (no freezing) Illuminated units: -25 to +55°C |
| Storage Temperature | -40 to +80°C |
| Operating Humidity | 45 to 85% RH (no condensation) |
| Operating Force | 50N |
| Minimum Force Required for Direct Opening Action | 5.5 mm |
| Maximum Operator Stroke | 10 mm |
| Contact Resistance | 50 mΩ maximum (initial value) |
| Insulation Resistance | 100 MΩ minimum (500V DC megger) |
| Dielectric Strength | Between live and dead metal parts Contacts: 2,500V AC, 1 minute Illuminated parts: 1,000V AC, 1 minute |
| Vibration Resistance | Damage limits: 30 Hz, amplitude 1.5 mm Operating extremes: 5 to 55 Hz, amplitude 0.5 mm |
| Shock Resistance | Damage limits: 1,000 m/s ² Operating extremes: 100 m/s ² |
| Operating Frequency | 900 operations/h |
| Life | Mechanical: 250,000 operations minimum Electrical: 100,000 operations minimum |
| Degree of Protection | IP65 |
| Terminal Style | M3.5 screw |
| Weight (approx.) | 58g (HN1E-BV402R) 65g (HN1E-LV402Q4R) |

Pushlock Turn Reset Switches (Unibody)

| Shape | Contact | Part No. | Button Color |
|--|---------|-------------|--------------|
|   | 1NO-1NC | HN1E-BV411R | Red only |
| | 2NC | HN1E-BV402R | |

- When pressed, the button is held depressed. The button is released by turning clockwise.
- Terminal cover HW-VL7 is supplied with the switch.

Illuminated Pushlock Turn Reset Switches (Unibody)

| Shape | Lamp | Contact | Part No. | Lens Color |
|--|--------------|---------|---------------|------------|
|   | Without Lamp | 1NO-1NC | HN1E-LV411Q0R | Red only |
| | | 2NC | HN1E-LV402Q0R | |

- When pressed, the button is held depressed. The button is released by turning clockwise.
- Terminal cover HW-VL7 is supplied with the switch.

Maintenance Parts

| Name | Part No. | Ordering No. | Package Quantity |
|-------------------------|----------|--------------|------------------|
| Terminal Cover for HW1E | HW-VL7 | HW-VL7PN10 | 10 |

ø30 HN Series Emergency Stop Switches

Dimensions

HN1E-BV4

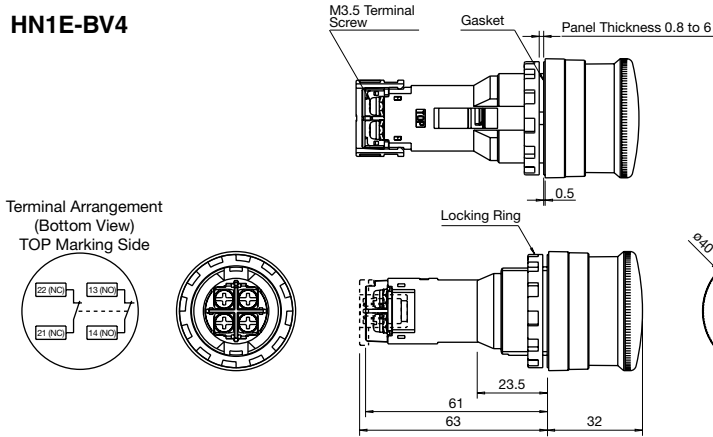

Panel Cut-Out

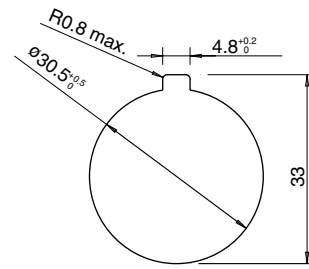

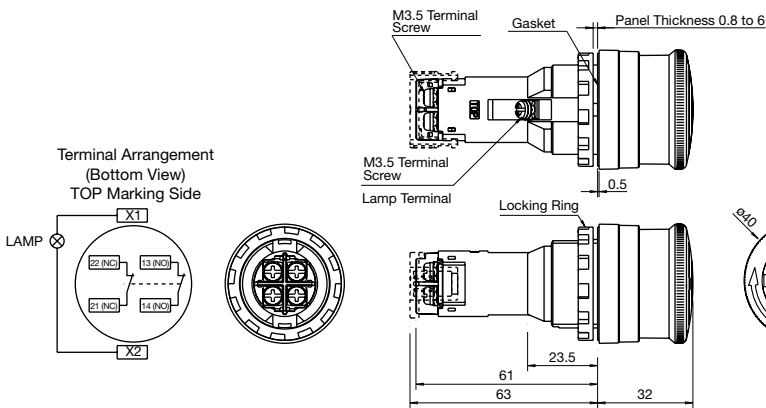

HN1E-LV4

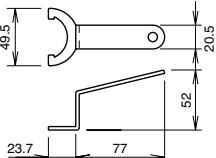

All dimensions in mm.

Accessories

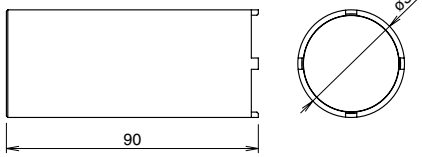
| Shape | Material | Part No. | Package Quantity | Remarks |
|---|----------|----------|------------------|--|
|  | Metal | TWST-T1 | 1 | Used for tightening the locking nut. Tighten the locking nut to a torque of 2.0 to 2.5 N·m.  |
|  | Brass | XN9Z-T1 | 1 | • Used to tighten the locking ring when installing the XN emergency stop switch onto a panel.  |

Nameplates (for ø30 Emergency Stop Switches)

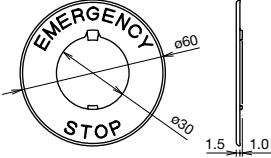
| Shape | Part No. | Legend | Package Quantity | Remarks |
|---|----------|----------------|------------------|---|
|  | HNAV-0 | (blank) | 1 | Background: Yellow Legend: Black Applicable panel thickness: 0.8 to 4.5 mm Material: Polyamide Legend "EMERGENCY STOP" is indicated outside a ø44mm circle.  |
| | HNAV-27 | EMERGENCY STOP | | |

HN Series Emergency Stop Switches ø30

Safety Precautions

- Turn off the power to the HN series before starting installation, removal, wiring, maintenance, and inspection. Failure to turn power off may cause electrical shocks or fire hazard.
- To avoid a burn on your hand, use the lamp holder tool when replacing lamps.
- For wiring, use wires of a proper size to meet the voltage and current requirements. Tighten the M3.5 terminal screws to a tightening torque of 1.0 to 1.3 N·m. Failure to tighten terminal screws may cause overheating and fire.

Operating Instructions

Panel Mounting

Tighten the locking ring using ring wrench XN9Z-T1 or TWST-T1 to a torque of 2.0 N·m maximum. Do not use pliers. Excessive tightening will damage the locking ring.

Installing and Removing the Lens

There is a groove each on the right and left of the lens. Insert a flat screwdriver into one of them and push upward. Take care not to lose a lens.

Replacing the LED lamp

Use the lamp holder tool (OR-55) to replace the LED lamp from the front of the panel.

[How to Remove]

To remove, slip the lamp holder tool (OR-55) onto the lamp head lightly. Then push slightly, and turn the lamp holder tool counterclockwise.



[How to Install]

To install, insert the lamp head into the lamp holder tool (OR-55).

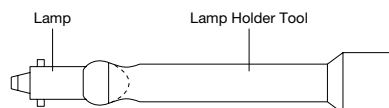

Place the pins on the lamp base to the grooves in the lamp socket. Inset the lamp and turn it clockwise.

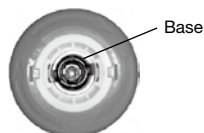

Do not apply excessive force onto the lamp in the base, otherwise the base will be damaged.

Notice on Wiring

When wiring, provide sufficient insulation between wires (crimping terminals).

Recommended Tightening Torque

1.0 to 1.3 N·m

SEMI Emergency Off (EMO) Switches

ø16mm XA Series EMO Switches (Solder Terminal) (Pushlock Turn Reset Switch)

Package Quantity: 1

| Shape | NC Main Contact | NO Monitor Contact | Part No. |
|---|-----------------|--------------------|-------------------------|
|  | 1NC | — | XA1E-BV401RH-EMO |
| | 2NC | — | XA1E-BV402RH-EMO |
| | 3NC | — | XA1E-BV403RH-EMO |
| | 4NC | — | XA1E-BV404RH-EMO |
| | 1NC | 1NO | XA1E-BV411RH-EMO |
| | 2NC | 1NO | XA1E-BV412RH-EMO |
| | 3NC | 1NO | XA1E-BV413RH-EMO |

- Button color is bright red (RH).
- For detailed specifications and instructions, see page 15.

ø22mm XW Series EMO Switch (Pushlock Turn Reset Switch)

Package Quantity: 1

| Shape | NC Main Contact | NO Monitor Contact | Part No. | |
|---|-----------------|--------------------|---------------------------|--------------------------|
| | | | IP20 Fingersafe Terminal | w/ Terminal Cover |
|  | 1NC | — | XW1E-BV401MFRH-EMO | XW1E-BV401MRH-EMO |
| | 2NC | — | XW1E-BV402MFRH-EMO | XW1E-BV402MRH-EMO |
| | 3NC | — | XW1E-BV403MFRH-EMO | XW1E-BV403MRH-EMO |
| | 4NC | — | XW1E-BV404MFRH-EMO | XW1E-BV404MRH-EMO |
| | 1NC | 1NO | XW1E-BV411MFRH-EMO | XW1E-BV411MRH-EMO |
| | 2NC | 1NO | XW1E-BV412MFRH-EMO | XW1E-BV412MRH-EMO |
| | 3NC | 1NO | XW1E-BV413MFRH-EMO | XW1E-BV413MRH-EMO |
| | 2NC | 2NO | XW1E-BV422MFRH-EMO | XW1E-BV422MRH-EMO |

- Button color is bright red (RH).
- For detailed specifications and instructions, see page 21.

ø22mm HW Series EMO Switches (Screw Terminal) (Pushlock Turn Reset Switch)

Package Quantity: 1

| Shape | Contact Arrangement | Part No. | Button Color |
|---|---------------------|-----------------------|--------------|
|  | 1NC | HW1B-V401R-EMO | Red only |
| | 1NO-1NC | HW1B-V411R-EMO | |
| | 2NC | HW1B-V402R-EMO | |
| | 2NO-2NC | HW1B-V422R-EMO | |

- For detailed specifications and instructions, see page 34.

Dimensions

ø16mm XA Series EMO Switches

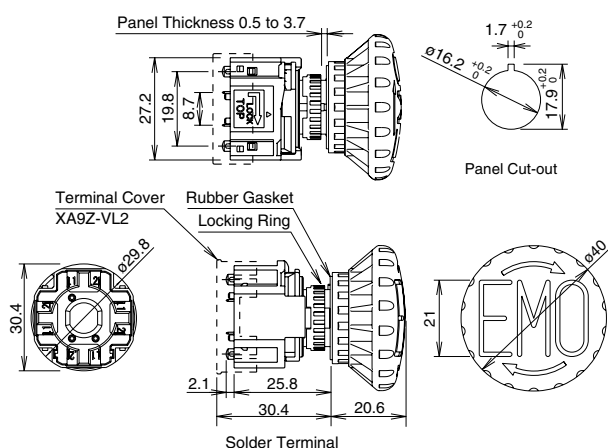

ø22mm XW Series EMO Switches

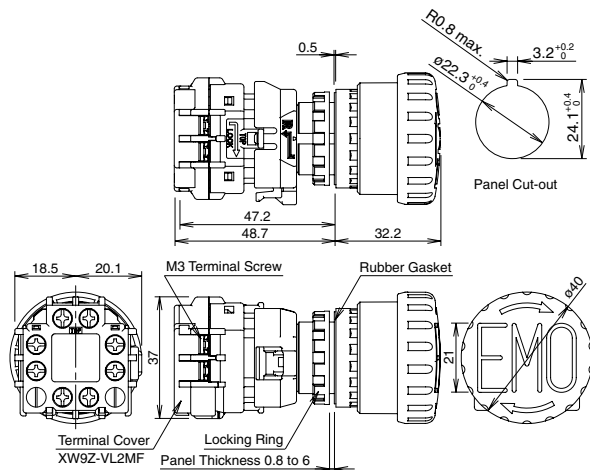

ø22mm HW Series EMO Switches

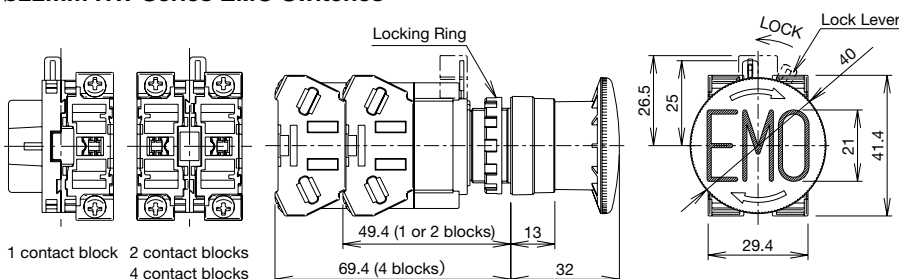

All dimensions in mm.

SEMI EMO Switch Guards

The combination of IDEC's EMO switch guards and emergency stop switches are approved by TÜV Rheinland for compliance with SEMI S2 standards.

SEMI S2-compliant Combinations

| EMO Switch Guard | Applicable Emergency Stop Switches |
|------------------|--|
| XA9Z-KG1 | XA1E-BV4****-EMO (①), XA1E-BV3 (②), XA1E-LV3 (③), XA1E-BV4 (③), XA1E-LV4 (③) |
| HW9Z-KG3 | XW1E-BV4****-EMO (④), XW1E-BV4 (⑤), XW1E-LV4 (⑤), XW1E-TV4 (⑤), HW1B-V3 (⑥), HW1B-V4 (⑦), HW1B-X4 (⑧), HW1B-Y2 (⑨) |
| HW9Z-KG4 | XW1E-BV4****-EMO (⑩), XW1E-BV4 (⑪), XW1E-LV4 (⑪), XW1E-TV4 (⑪), XW1E-BV5 (⑫), HW1B-V3 (⑬), HW1B-V4 (⑭), HW1E (⑮), HW1B-X4 (⑯), HW1B-Y2 (⑰) |
| HW9Z-KG5 | XW1E-BV4****-EMO (⑱), XW1E-BV4 (⑲), XW1E-LV4 (⑲), XW1E-TV4 (⑲), XW1E-BV5 (⑳), HW1B-V3 (㉑), HW1B-V4 (㉒), HW1E (㉓), HW1B-X4 (㉔), HW1B-Y2 (㉕) |

XA9Z-KG1



HW9Z-KG3

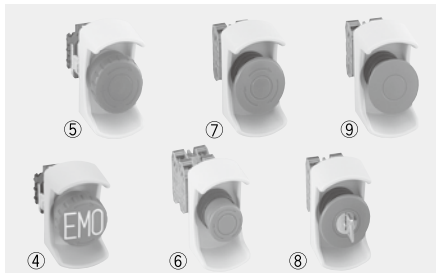

HW9Z-KG4



HW9Z-KG5

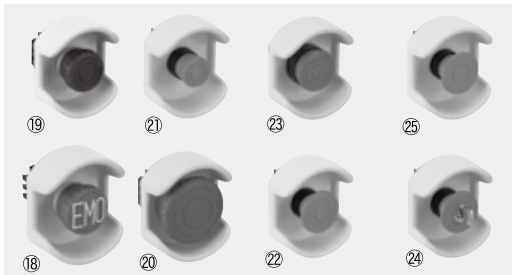

Note:

EMO switch guards have been designed for applications in semiconductor manufacturing equipment only. Do not use EMO switch guards with emergency stop switches which are installed on machine tools or food processing machines. (Machinery Directive of the European Commission and IEC 60204-1 require that emergency stop switches be installed in a readily accessible area, and the usage of switch guards is not permitted.)

About SEMI

SEMI is an international industry association whose member companies produce materials, equipment, and related technology for manufacturing semiconductor, flat panel display (FPD), and micro-electromechanical systems (MEMS) products. The SEMI safety guideline was published for the semiconductor industry and it is observed with the same importance as standards.

SEMI S2-0706, 12.1 describes as follows; "The equipment should have an 'emergency off' (EMO) circuit. The EMO actuator (e.g., button), when activated, should place the equipment into a safe shutdown condition, without generating any additional hazard to personnel or the facility." Because the semiconductor environment involves solvents and chemicals in many cases, some of which are toxic, interrupting the power source may cause secondary accidents. SEMI safety guideline requires the installation of an emergency off switch which disconnects only the part responsible for the hazardous situation, and maintains the functions of safety-related devices (e.g., smoke detectors, gas/water leak detectors, pressure measurement devices, etc.).

Emergency off buttons should be located or guarded to minimize accidental activation (SEMI S2-0706, 12.5.1). The emergency off button should be red and mushroom shaped. A yellow background for the EMO should be provided (SEMI S2-0706, 12.3).

- Location of EMO switches on semiconductor manufacturing equipment
Acceptance criteria: controls should not be located above 1638 mm (64.5 in.) or below 838 mm (33 in.) (SEMI S8-0705, 9.1.2).
- No operation or regularly scheduled maintenance location should require more than 3 m (10 feet) travel to an EMO button (S2-0706, 12.5.2).

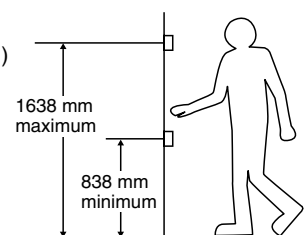







SEMI EMO Switch Guards

SEMI S2 Compliant Switch Guards

Switch Guards

Package Quantity: 1

| Series | Description & Shape | Part No. | Applicable Switches | Remarks |
|-----------------------|---|------------------|--|--|
| ø16mm XA Series | ø16 mm EMO Switch Guard  | XA9Z-KG1 | XA1E-BV3 XA1E-BV4 XA1E-LV3 XA1E-LV4 | <ul style="list-style-type: none"> SEMI S2 compliant (The combination of IDEC's emergency stop switches and EMO switch guards are approved by TÜV Rheinland for compliance with SEMI S2 standard.) |
| ø22mm HW/XW Series | ø22 mm EMO Switch Guard  | HW9Z-KG1 | XW1E-BV4 XW1E-LV4 XW1E-TV4 HW1B-V3 HW1B-V4 HW1B-X4 HW1B-Y2 HW1E-BV4 HW1E-LV4 | <ul style="list-style-type: none"> SEMI S2-0703, 12.5.1 compliant. Widely used switch guard in many applications. |
| | ø22 mm EMO Switch Guard  | HW9Z-KG2 | XW1E-BV4 XW1E-LV4 XW1E-TV4 HW1B-V3 HW1B-V4 HW1B-X4 HW1B-Y2 HW1E-BV4 HW1E-LV4 | <ul style="list-style-type: none"> SEMI S2-0703, 12.5.1 compliant. SEMATECH Application Guide for SEMI S2-93, 12.4. compliant. The round shape is effective to prevent inadvertent operation from any direction. |
| | ø22 mm EMO Switch Guard  | HW9Z-KG3 | XW1E-BV4 XW1E-LV4 XW1E-TV4 HW1B-V3 HW1B-V4 HW1B-X4 HW1B-Y2 HW1E-LV4 | <ul style="list-style-type: none"> SEMI S2 compliant (The combination of IDEC's emergency stop switches and EMO switch guards are approved by TÜV Rheinland for compliance with SEMI S2 standard.) The smallest switch guard for ø22 series switches. Can be installed on FB control boxes. |
| | ø22 mm EMO Switch Guard  | HW9Z-KG4* | XW1E-BV4 XW1E-BV5 XW1E-LV4 XW1E-TV4 HW1B-V3 HW1B-V4 HW1B-X4 HW1B-Y2 HW1E-BV4 HW1E-LV4 | <ul style="list-style-type: none"> SEMI S2 compliant (The combination of IDEC's emergency stop switches and EMO switch guards are approved by TÜV Rheinland for compliance with SEMI S2 standard.) SEMATECH Application Guide for SEMI S2-93, 12.4. compliant. Narrower than HW9ZKG5. Saves more space. Can be installed on FB control boxes. Available in white. |
| | ø22 mm EMO Switch Guard  | HW9Z-KG5* | XW1E-BV4 XW1E-LV4 XW1E-TV4 XW1E-BV5 HW1B-V3 HW1B-V4 HW1B-X4 HW1B-Y2 HW1E-BV4 HW1E-LV4 | <ul style="list-style-type: none"> SEMI S2 compliant (The combination of IDEC's emergency stop switches and EMO switch guards are approved by TÜV Rheinland for compliance with SEMI S2 standard.) SEMATECH Application Guide for SEMI S2-93, 12.4. compliant. A nameplate can be installed. Available in white.  |

- Specify a color code in place of *. Blank: yellow (Munsell 2.5Y8/10 or equivalent), -W: white (Munsell N9.5)
- Material: polyamide (PA6), degree of protection: IP65 (IEC 60529)

SEMI EMO Switch Guards

SEMI S2 Compliant Switch Guards

Dimensions

All dimensions in mm.

XA9Z-KG1

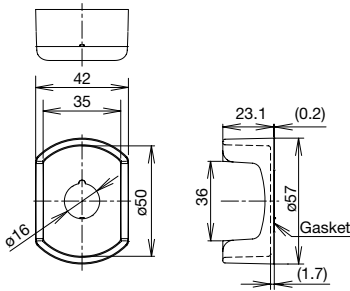

HW9Z-KG1

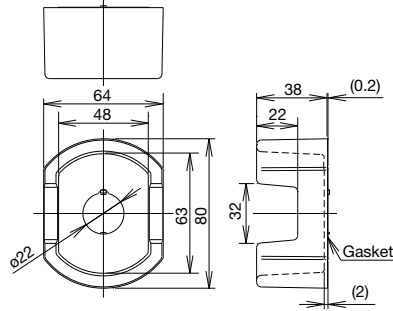

HW9Z-KG2

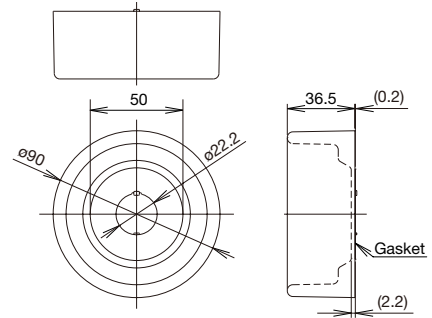

HW9Z-KG3

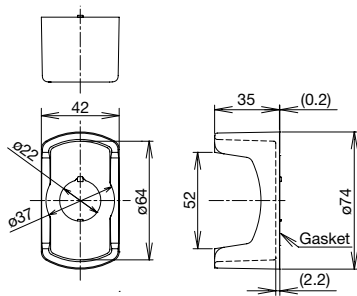

HW9Z-KG4

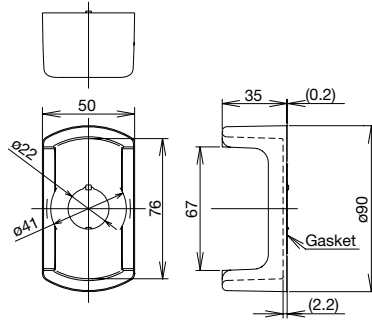

HW9Z-KG5

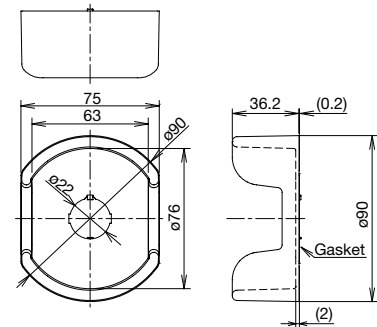

• Panel thickness: 1.2 to 4.0 mm
(1.2 to 2.6 mm when using an HWAV nameplate)

Panel Cut-out

ø16mm

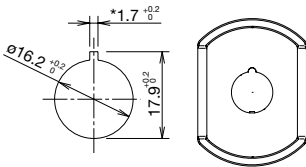

The * 1.7^{+0.2} recess is for preventing rotation and not necessary when anti-rotation is not used.

ø22mm

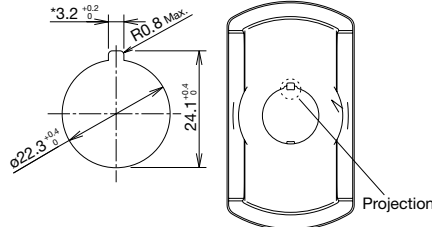

The * 3.2^{+0.2} recess is for preventing rotation and not necessary when anti-rotation is not used.
When anti-rotation is not required or when the panel cut-out does not have anti-rotation recess, remove the projection using pliers.

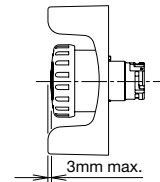

Note: The height of the applicable switch and guard will be 3 mm or less as shown in the diagram on the right.

Installation

ø16 mm

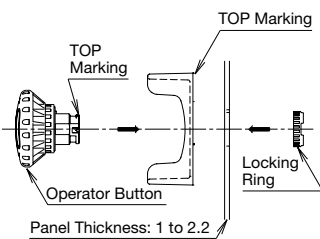

ø22 mm

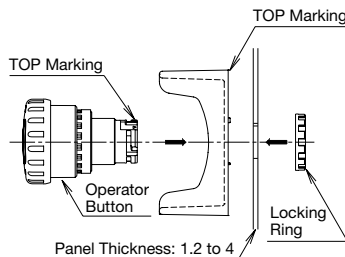

To tighten the locking ring, use locking ring wrench MT-100 and tighten to a torque of 0.88 N-m.

To tighten the locking ring, use locking ring wrench MW9Z-T1 and tighten to a torque of 2.0 N-m.

EMO Sticker

Part No.: HW9Z-EMO-NPP
Color: Yellow (red legend)
Package Quantity: 10

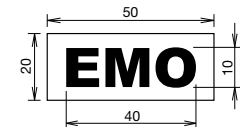
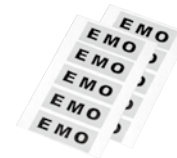

Nameplate (for ø22 mm Emergency Stop Switches)

| Name | Legend | Part No. | Remarks |
|--------------------|---------------|-----------|--|
| For ø40mm Mushroom | EMERGENCY OFF | HWAV-74-Y | <ul style="list-style-type: none"> Nameplate color: yellow Legend color: black |

Stop Switches



Wider variety with yellow button, white guard and nameplate

According to SEMI S26-0308 Environmental, Health, and Safety Guideline for FPD Manufacturing Systems published in March 2008, the combination of a red button and yellow background cannot be used for switches that have only local or partial shut down functions. IDEC's yellow button switch, white switch guard, and nameplate can satisfy the requirement.

Stop Switches

ø16mm X6 series Stop Switch Pushlock Pull or Turn Reset Unibody (Solder Terminal)



Package quantity: 1

| Description & Shape | Operator | NC Main Contact | Part No. |
|---|----------|-----------------|---------------------|
| (Photo: ø30mm Mushroom)   | ø30mm | 1NC | AB6E-3BV01PY |
| | | 2NC | AB6E-3BV02PY |
| | ø40mm | 1NC | AB6E-4BV01PY |
| | | 2NC | AB6E-4BV02PY |

- Pushlock pull or turn reset is locked when pressed, and reset when pulled or turned clockwise.
- Do not use yellow stop switches as emergency stop switches.
- See page 8 for specifications and instructions.

ø16mm XA series Stop Switch Pushlock Pull or Turn Reset Unibody (Solder Terminal)





Package quantity: 1

| Description & Shape | Operator | NC Main Terminal | Part No. | |
|--|----------|------------------|-----------------------|----------------------|
| | | | IP40 | IP65 |
| (Photo: ø29mm Mushroom)   | ø29mm | 1NC | XA1E-BV3U01K ① | XA1E-BV3U01 ① |
| | | 2NC | XA1E-BV3U02K ① | XA1E-BV3U02 ① |
| | ø40mm | 1NC | XA1E-BV4U01K ① | XA1E-BV4U01 ① |
| | | 2NC | XA1E-BV4U02K ① | XA1E-BV4U02 ① |

- Specify button color code Y (yellow) or N (gray) in place of ① in the Part No.
- Pushlock pull or turn reset is locked when pressed, and reset when pulled or turned clockwise.
- Solder/tab 110 terminal is available. To order, insert "T" before the Y in the Part No. Example: XA1E-BV3U02KY→XA1E-BV3U02KTY
- See page 13 for specifications and instructions.

ø16mm XA series Stop Switch Pushlock Pull or Turn Reset with Removable Contact Block

Package quantity: 1



| Description & Shape | NC Main Contact | NO Monitor Contact | Part No. | |
|--|-----------------|--------------------|---------------------|----------------------|
| | | | Solder Terminal | PCB Terminal |
| ø29mm Mushroom   | 1NC | — | XA1E-BV301 ① | XA1E-BV301V ① |
| | 2NC | — | XA1E-BV302 ① | XA1E-BV302V ① |
| | 3NC | — | XA1E-BV303 ① | XA1E-BV303V ① |
| | 4NC | — | XA1E-BV304 ① | XA1E-BV304V ① |
| | 1NC | 1NO | XA1E-BV311 ① | XA1E-BV311V ① |
| | 2NC | 1NO | XA1E-BV312 ① | XA1E-BV312V ① |
| | 3NC | 1NO | XA1E-BV313 ① | XA1E-BV313V ① |
| ø40mm Mushroom   | 1NC | — | XA1E-BV401Y | XA1E-BV401VY |
| | 2NC | — | XA1E-BV402Y | XA1E-BV402VY |
| | 3NC | — | XA1E-BV403Y | XA1E-BV403VY |
| | 4NC | — | XA1E-BV404Y | XA1E-BV404VY |
| | 1NC | 1NO | XA1E-BV411Y | XA1E-BV411VY |
| | 2NC | 1NO | XA1E-BV412Y | XA1E-BV412VY |
| | 3NC | 1NO | XA1E-BV413Y | XA1E-BV413VY |

- Specify button color code Y (yellow) or N (gray) in place of ① in the Part No.
- Pushlock pull or turn reset is locked when pressed, and reset when pulled or turned clockwise.
- Terminal cover (XA9Z-VL2) is not supplied and must be ordered separately.
- See page 15 for specifications and instructions.

Stop Switches

ø22mm XW series Stop Switches Pushlock Pull / Turn Reset (Screw Terminal)

Package quantity: 1

| Description & Shape | Main Contact | Monitor Contact | Part No. | |
|--|--------------|-----------------|----------------------|---------------------|
| | | | IP20 Terminal | w/Terminal Cover |
| ø40mm Mushroom   | 1NC | — | XW1E-BV401MFY | XW1E-BV401MY |
| | 2NC | — | XW1E-BV402MFY | XW1E-BV402MY |
| | 3NC | — | XW1E-BV403MFY | XW1E-BV403MY |
| | 4NC | — | XW1E-BV404MFY | XW1E-BV404MY |
| | 1NC | 1NO | XW1E-BV411MFY | XW1E-BV411MY |
| | 2NC | 1NO | XW1E-BV412MFY | XW1E-BV412MY |
| | 3NC | 1NO | XW1E-BV413MFY | XW1E-BV413MY |
| | 2NC | 2NO | XW1E-BV422MFY | XW1E-BV422MY |

- Pushlock, pull or turn reset is locked when pressed, and reset when pulled or turned clockwise.
- Specify IP20 terminal or terminal cover with the Part No.
- IP20 terminal type can be connected using solid wires only.
- See page 21 for specifications and instructions.

ø22mm HW series Stop Switches



Package quantity: 1

| Description & Shape | Contact Configuration | Part No. | | |
|--|-----------------------|-------------------|-------------------|----------------------|
| | | ø29mm Mushroom | ø40mm Mushroom | ø60mm Jumbo Mushroom |
| Pushlock Turn Reset (Photo: ø29mm Mushroom)   | 1NC | HW1B-V301Y | HW1B-V401Y | HW1B-V501Y |
| | 1NO-1NC | HW1B-V311Y | HW1B-V411Y | HW1B-V511Y |
| | 2NC | HW1B-V302Y | HW1B-V402Y | HW1B-V502Y |
| | 2NO-2NC | HW1B-V322Y | HW1B-V422Y | HW1B-V522Y |
| Push-Pull ø40mm Mushroom (2-position)   | 1NC | — | HW1B-Y201Y | — |
| | 1NO-1NC | — | HW1B-Y211Y | — |
| | 2NC | — | HW1B-Y202Y | — |

- Pushlock turn reset is locked when pressed, and reset when turned clockwise.
- Push-pull is a 2-position switch which is maintained in both pressed and reset (pull) positions.
- See page 32 for specifications and instructions.

Stop Switches

Nameplates (White)

| Shape | Description | Part No. | Material | Plate Color | Legend |
|--|---------------------------|------------------|-----------|----------------------|--------|
| For $\phi 16$ mm Series  | For $\phi 29$ mm Mushroom | HAAV-0-W | Polyamide | White (Munsell N9.5) | Blank |
| | For $\phi 49$ mm Mushroom | HAAV4-0-W | | | |
| For $\phi 22$ mm Series  | For $\phi 40$ mm Mushroom | HWAV-0-W | | | |
| | For $\phi 60$ mm Mushroom | HWAV5-0-W | | | |

Dimensions

For $\phi 16$ mm Series
(Nameplate for $\phi 29$ mm Mushroom)

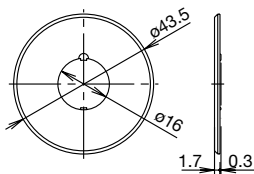

Panel thickness: 0.5 to 2 mm when using a nameplate

(Nameplate for $\phi 40$ mm Mushroom)

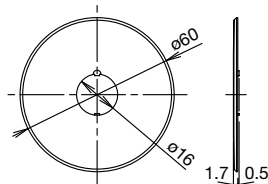

Panel thickness: 0.5 to 2 mm when using a nameplate

For $\phi 22$ mm Series
(Nameplate for $\phi 40$ mm Mushroom)

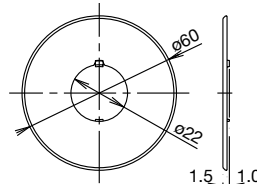

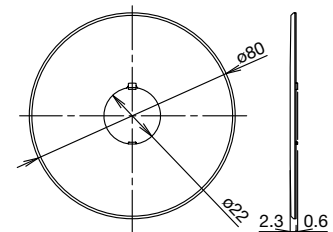

Panel thickness: 0.8 to 4.5 mm when using a nameplate

(Nameplate for $\phi 60$ mm Mushroom)



Panel thickness: 0.8 to 4 mm when using a nameplate

Switch Guard (White)

| Description & Shape | Part No. | Remarks |
|--|-------------------|---|
| For $\phi 22$ mm HW/XW Series  | HW9Z-KG4-W | <ul style="list-style-type: none"> • Inside diameter $\phi 76$mm • Space-saving, 50 mm-wide. |
| For $\phi 22$ mm HW/XW Series  | HW9Z-KG5-W | <ul style="list-style-type: none"> • Inside diameter $\phi 76$mm |

IDEC CORPORATION

Head Office

6-64, Nishi-Miyahara-2-Chome, Yodogawa-ku, Osaka 532-0004, Japan

 www.idec.com

| | | | | | | | |
|------------------|-------------------------------|--------------------------|----------------------|-----------------------|-----------------------------|------------------------|----------------------|
| USA | IDEC Corporation | Tel: +1-408-747-0550 | opencontact@idec.com | Hong Kong | IDEC Izumi (H.K.) Co., Ltd. | Tel: +852-2803-8989 | info@hk.idec.com |
| Germany | IDEC Electrotechnik GmbH | Tel: +49-40-25 30 54 - 0 | service@eu.idec.com | China/Shanghai | IDEC (Shanghai) Corporation | Tel: +86-21-6135-1515 | idec@cn.idec.com |
| Singapore | IDEC Izumi Asia Pte. Ltd. | Tel: +65-6746-1155 | info@sg.idec.com | China/Shenzhen | IDEC (Shenzhen) Corporation | Tel: +86-755-8356-2977 | idec@cn.idec.com |
| Thailand | IDEC Asia (Thailand) Co., Ltd | Tel: +66-2-392-9765 | sales@th.idec.com | China/Beijing | IDEC (Beijing) Corporation | Tel: +86-10-6581-6131 | idec@cn.idec.com |
| Australia | IDEC Australia Pty. Ltd. | Tel: +61-3-8523-5900 | sales@au.idec.com | Japan | IDEC Corporation | Tel: +81-6-6398-2527 | marketing@idec.co.jp |
| Taiwan | IDEC Taiwan Corporation | Tel: +886-2-2698-3929 | service@tw.idec.com | | | | |

Specifications and other descriptions in this brochure are subject to change without notice.
2017 IDEC Corporation, All Rights Reserved.

EP1430-13 MAY 2017



EMO

XW1E-BV413MFRH- XW1E-BV413R
EMO

XW1E-
LV402Q4MFR

EMO

XW1E-LV402Q4R

EMO

XW1E-LV413Q4R