

MicroSmart

EXPANDING YOUR CONTROL



idec

MICROSmart FC4A Series Micro PLC



Table of Contents

MicroSmart FC4A Series Micro PLC	2-3
Multipule Standard Features	4-5
Add And Combine Modules	6
Customize MicroSmart To Meet Your Needs	7
CPU Modules	8
Expansion Modules And Options	9-11
Easy Operation Using The HMI Module	12
Communication Capabilities	13
Compatible Programming Software	14
Product List	23
Specifications	16-22
Programming Instruction Commands	23
Dimensions	25-26
Accessories	27



MICROSmart

IDEC Corporation, a pioneer in the micro-PLC field, is proud to offer the MicroSmart series of programmable logic controllers, the latest in the Micro family of PLCs. These flexible, adaptable PLCs are as compact as they are powerful, so you can create the system you need without increasing your space requirements or your budget.

The CPU That's Right For You

MicroSmart CPUs are available in two types of modules, All-in-One and Slim. The All-in-One type has models with 10, 16, or 24 I/O points; the Slim type is available in four different 20 I/O modules and two 40 I/O modules. Each CPU module is only 90mm in height and 70mm deep, but it has built-in inputs and outputs as well as standard features like high-speed counters, a RS-232C port and an analog potentiometer. Choose the CPU that's right for you and see what else MicroSmart has to offer.

Expand Your Control

The Slim type and the 24 I/O All-in-One type CPUs can expand into the ideal system using the optional expansion modules. Need more inputs? More outputs? Some of both? There are 18 available expansion modules, including four analog I/O modules. Depending on your CPU, you can create a system with as many as 264 I/O points (40 I/O Slim type CPU with seven expansion modules).

Customize Your System

Once you have all the control you need, select the features you want. Store and transfer programs on the memory cartridge or install a real-time clock and calendar cartridge. Add another communications port or an HMI module — it's all possible with MicroSmart. It's even UL-1604 listed, Class 1—Div. 2 for hazardous locations. Create the perfect solution for all of your applications, exactly the way you want it.

Multiple Standard Features

Pulse Output/Trapezoidal Control

Independent dual-axis control is available with two pulse outputs. Locational values can be easily defined for precise positional (trapezoidal) control.

- * Pulse output instruction
- * PWM instruction
(Pulse Width Modulation control)

Pulse Output Function Specifications

Number of output points	2
Maximum output frequency	20 kHz

*Only one point of trapezoidal control is available.

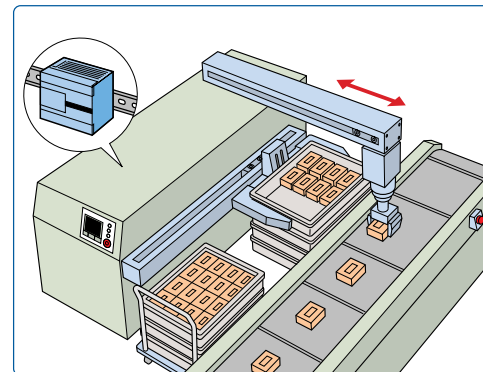

Setting the desired values enables you to precisely manage the trapezoidal control

Operation mode (S1)	1
Steady pulse frequency (S1 + 1)	50
Initial pulse frequency (S1 + 2)	10
Frequency change rate (S1 + 3)	2
Preset value (S1 + 6, 7)	10,000

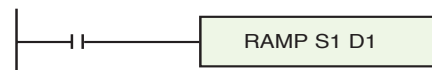
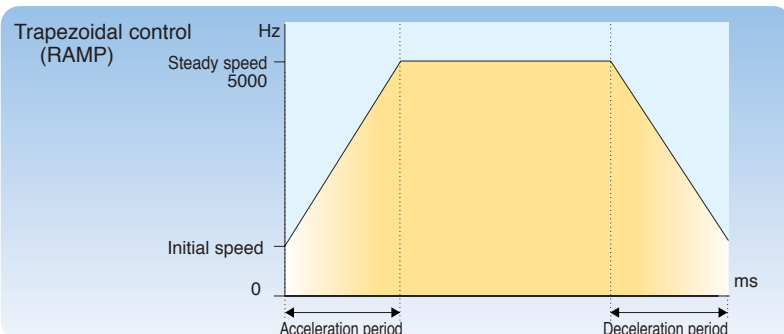

PID Control

To automatically maintain a target water temperature (PID control), use the auto tuning function to perform sampling. Based on the determined PID parameters, PID control is executed automatically. (Slim type CPU units only.)

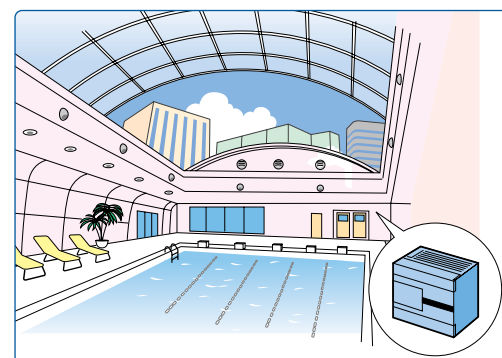

Set point	30
AT set point	25
High alarm value	35
Low alarm value	27

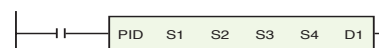
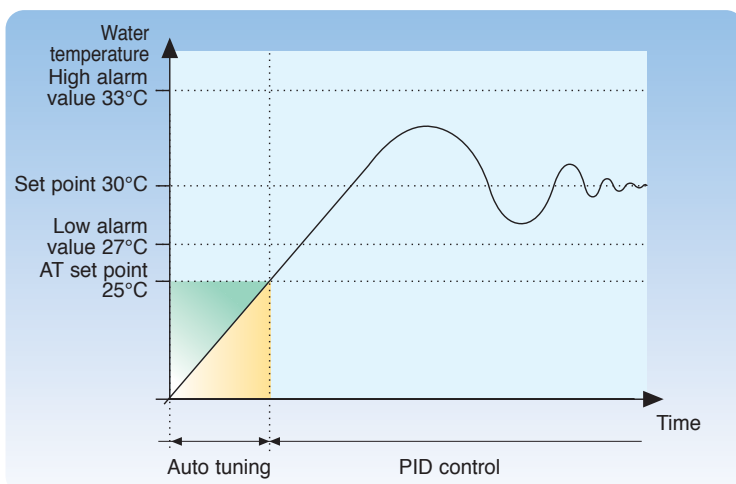

High-speed Counters

The MicroSmart has four built-in high speed counters. One high speed counter (all-in-one type) or two high speed counters (slim type) can be used as either two-phase or single-phase high speed counters at a maximum of 20kHz. The other three (all-in-one type) or two (slim type) have a maximum frequency of 5kHz. High speed counters are used for simple positioning and motor control.

Type	Single-phase	Two-phase
Maximum Input Frequency	HSC1 and 4: 20 kHz	HSC1: 20 kHz
Counting Range	HSC2 and 3: 5 kHz	HSC4: 20 kHz (SlimType CPU)
Operation Mode	16 bits (0 to 65,535)	16 bits (0 to 65,535)
Gate Input	Adding counter	Rotary encoder (phases A, B, Z)
Current Value Reset	Enable/disable counting	Enable/disable counting
Current Value Reset	Current value is reset to zero when the current value reaches the pre-set value.	Current value is reset to a given value when overflow or underflow has occurred.

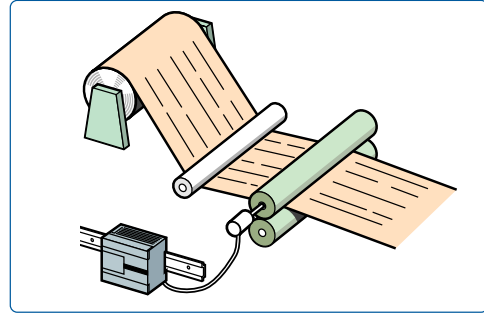

The rotary encoder can connect directly to the paper feeder. The high-speed counter receives and reads output pulses from the rotary encoder.

Analog Potentiometer

The analog potentiometer built into the CPU module enables settings to be adjusted without special tools.

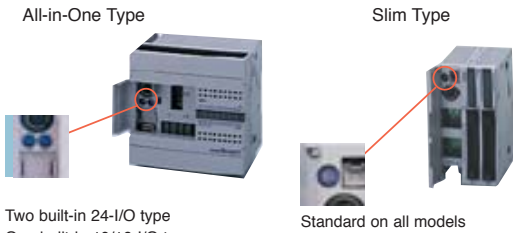

Two built-in 24-I/O type
One built-in 10/16-I/O types

Standard on all models

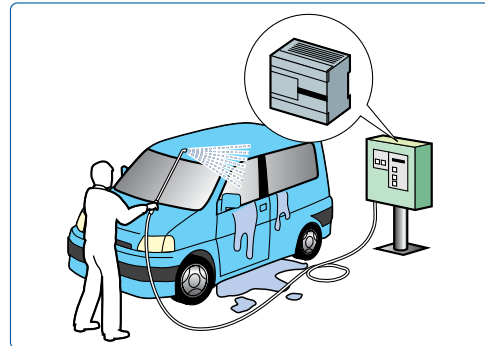

After installation the analog potentiometer in the CPU module allows you to easily change values such as timer preset values or the volume of water.

Built-in Analog Voltage Input

Ready for connecting 0 to 10V DC from an external device directly to the built-in analog voltage input connector (Slim type CPU modules only).

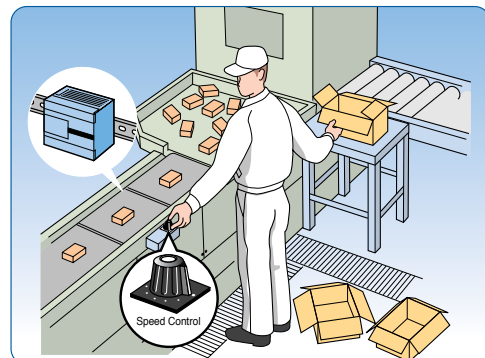
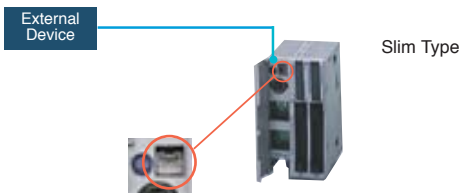

Add And Combine Modules

All-In-One Type

- Attach Max. 4 Expansion Modules
- Max. I/O 88 points
- Only FC4A-C24R2 CPU Module is expandable

Note: The maximum number of relay outputs that can be turned on simultaneously is 33 points including relay outputs on the CPU module.

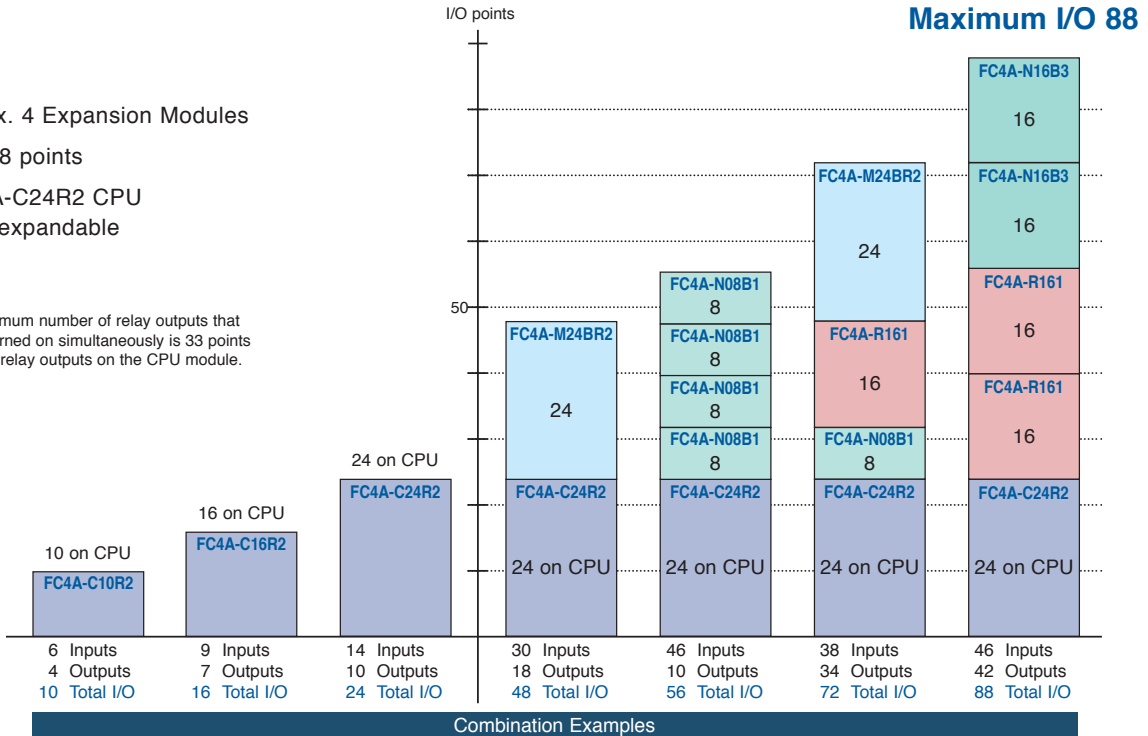

Slim Type

- Attach Max. 7 Expansion Modules
- Max. I/O 148 points (D20K3, D20S3)
244 points (D20RK1, D20RS1)
264 points (D40K3, D40S3)

Note: The maximum number of relay outputs that can be turned on simultaneously is 54 points including relay outputs on the CPU module.

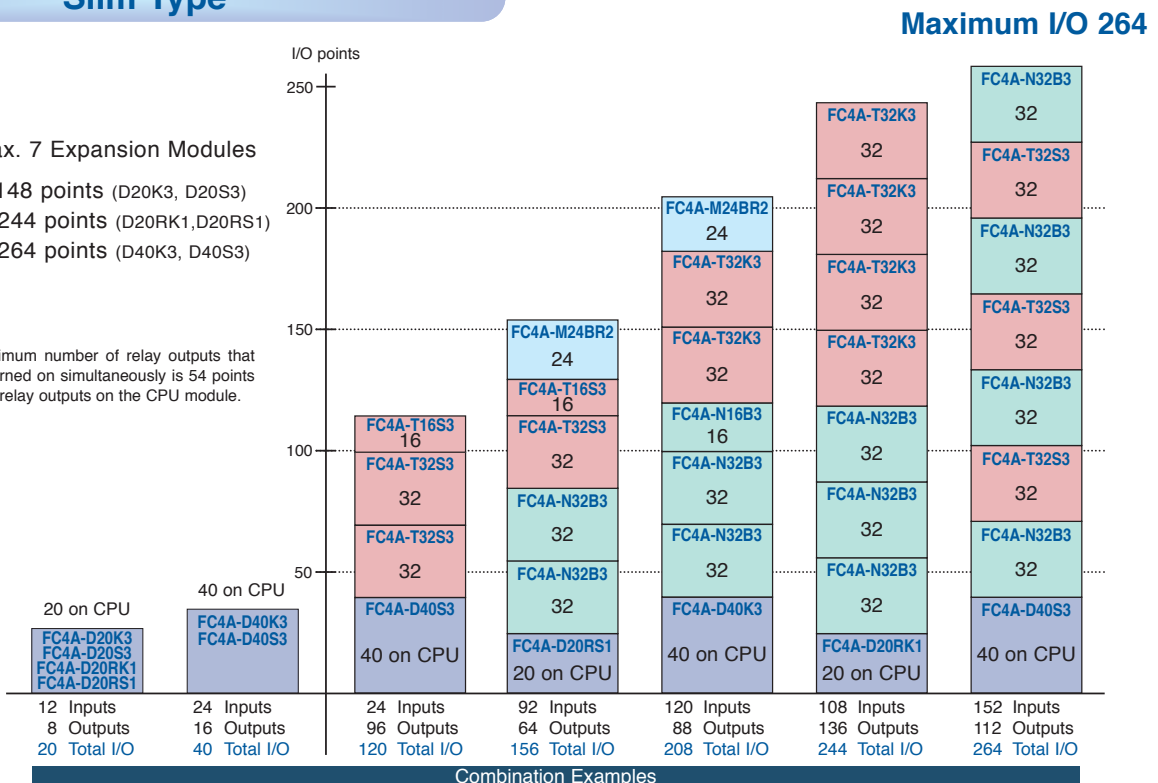

Customize MicroSmart To Meet Your Needs

All-in-One Type

FC4A-C10R2, FC4A-C16R2, FC4A-C24R2

Communication Adapters (FC4A-C10R2 not applicable)

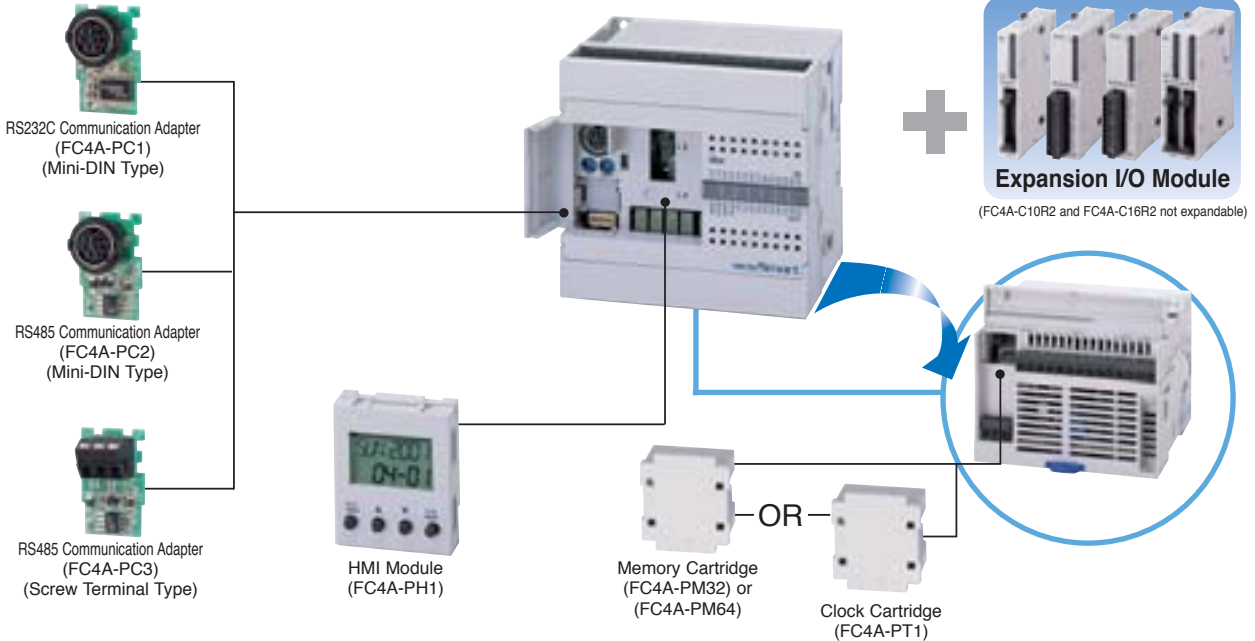

Slim Type

FC4A-D20K3, FC4A-D20S3, FC4A-D20RK1
FC4A-D20RS1, FC4A-D40K3, FC4A-D40S3

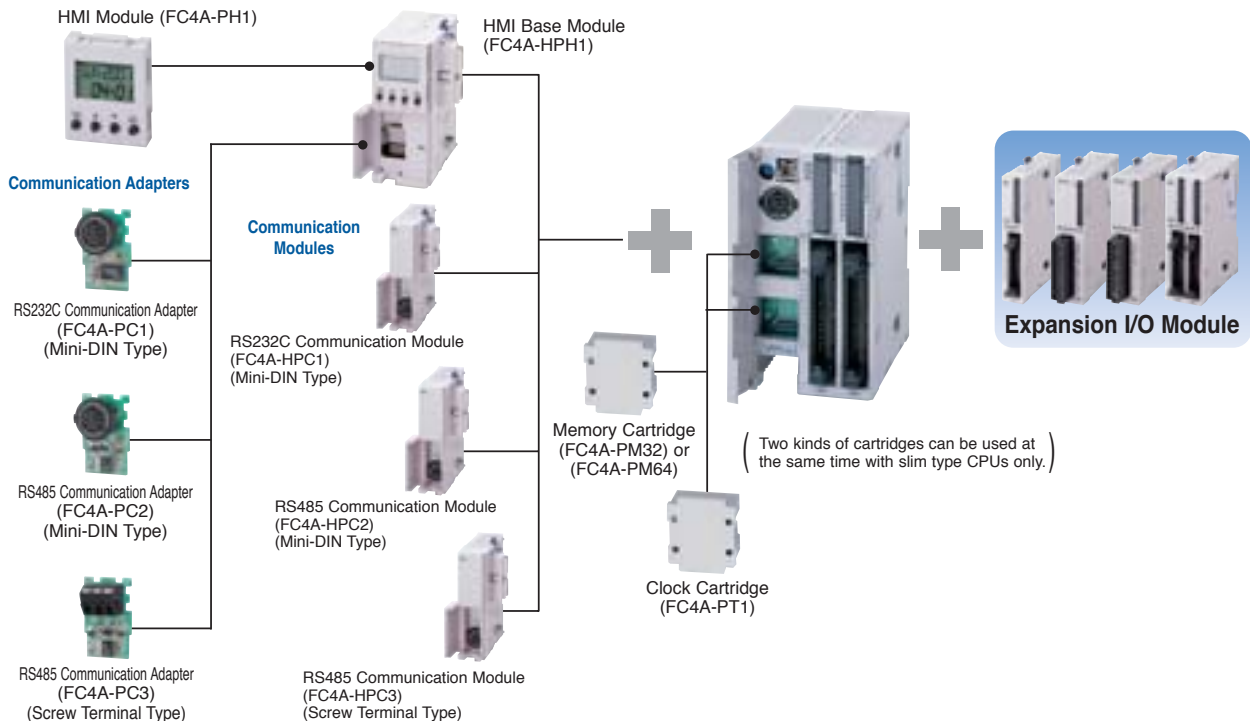

CPU Modules

CPU Modules



FC4A-C10R2
6 input points
4 output points
Relay output
100 to 240V AC
4.8KB memory



FC4A-C16R2
9 input points
7 output points
Relay output
100 to 240V AC
15KB memory



FC4A-C24R2
14 input points
10 output points
Relay output
100 to 240V AC
27KB memory
88 max I/O expandability

I/O modules not applicable to these two models



FC4A-D20K3
12 input points
8 output points
0.3A transistor sink output
24V DC
27KB memory
148 max I/O expandability



FC4A-D20RK1
12 input points
8 output points
0.3A transistor sink output
24V DC
31.2KB memory
244 max I/O expandability
240V AC-2A/30V DC-2A relay output

*Transistor output 2 points and relay output 6 points



FC4A-D40K3
24 input points
16 output points
0.3A transistor sink output
24V DC
31.2KB memory
264 max I/O expandability



FC4A-D20S3
12 input points
8 output points
0.3A transistor source output
24V DC
27KB memory
148 max I/O expandability



FC4A-D20RS1
12 input points
8 output points
0.3A transistor source output
24V DC
31.2KB memory
244 max I/O expandability
240V AC-2A/30V DC-2A relay output

*Transistor output 2 points and relay output 6 points



FC4A-D40S3
24 input points
16 output points
0.3A transistor source output
24V DC
31.2KB memory
264 max I/O expandability

Expansion Modules And Options

DC Input Modules - 4 Types



**8-point DC Input Module
FC4A-N08B1**
8 input points
24V DC sink/source input
Removable screw terminal



**16-point DC Input Module
FC4A-N16B1**
16 input points
24V DC sink/source input
Removable screw terminal



**16-point DC Input
Module
FC4A-N16B3**
16 input points
24V DC sink/source input
MIL connector



**32-point DC Input
Module
FC4A-N32B3**
32 input points
24V DC sink/source input
MIL connector

Output Modules - 8 Types



**8-point Relay
Output Module
FC4A-R081**
8 output points
Relay output (1NO contact)
Removable screw terminal



**16-point Relay
Output Module
FC4A-R161**
16 output points
Relay output (1NO contact)
Removable screw terminal



**8-point Transistor
Sink Output Module
FC4A-T08K1**
8 output points
0.3A transistor sink output
Removable screw terminal



**8-point Transistor
Source Output Module
FC4A-T08S1**
8 output points
0.3A transistor source output
Removable screw terminal



**16-point Transistor
Sink Output Module
FC4A-T16K3**
16 output points
0.1A transistor sink output
MIL connector



**16-point Transistor
Source Output Module
FC4A-T16S3**
16 output points
0.1A transistor source output
MIL connector



**32-point Transistor
Sink Output Module
FC4A-T32K3**
32 output points
0.1A transistor sink output
MIL connector



**32-point Transistor
Source Output Module
FC4A-T32S3**
32 output points
0.1A transistor source output
MIL connector

Expansion Modules And Options Cont.

Combination I/O Modules - 2 Types



**4 Input/4 Output
Combination Module
FC4A-M08BR1**
4 input points/4 output points
24V DC sink/source input
240V AC-2A/30V DC-2A relay output
Removable screw terminal



**16 Input/8 Output
Combination Module
FC4A-M24BR2**
16 input points/8 output points
24V DC sink/source input
240V AC-2A/30V DC-2A relay output
Wire-clamp terminal

Analog Modules - 4 Types



**1 Output
Analog Module
FC4A-K1A1**
1 analog output (voltage/current)
Removable screw terminal



**2 Input
Analog Module
FC4A-J2A1**
2 analog input (voltage/current)
Removable screw terminal



**2 Input/1 Output
Analog Module
FC4A-L03AP1**
2 analog input (thermocouple/RTD)
1 analog output (voltage/current)
Removable screw terminal



**2 Input/1 Output
Analog Module
FC4A-L03A1**
2 analog input (voltage/current)
1 analog output (voltage/current)
Removable screw terminal

Expansion Module Examples



(Example 1)

Module	Type No.	Input	Output
CPU	FC4A-C24R2	14	10
DC Input	FC4A-N16B1	16	0
DC Input	FC4A-N16B1	16	0
Relay Output	FC4A-R161	0	16
Relay Output	FC4A-R161	0	16
Total		46	42



(Example 2)

Module	Type No.	Input	Output
CPU	FC4A-C24R2	14	10
DC Input	FC4A-N08B1	8	0
DC Input/Relay Output	FC4A-M08BR1	4	4
Relay Output	FC4A-R081	0	8
Transistor Sink Output	FC4A-T08K1	0	8
Total		26	30

Option Modules



HMI Base Module
(FC4A-HPH1)



HMI Module
(FC4A-PH1)



Memory Cartridge
(FC4A-PM32)
(FC4A-PM64)



Clock Cartridge
(FC4A-PT1)

Communication Adapters



(FC4A-PC1)



(FC4A-PC2)



(FC4A-PC3)

Slim Type Communication Modules



(FC4A-HPC1)



(FC4A-HPC2)



(FC4A-HPC3)

Type	CPU Module	HMI Module	Memory Cartridge	Clock Cartridge	Communication Adapter
All-in-one Type	24	YES	YES Select one cartridge		YES
	16				YES
	10				—
Slim Type	40	YES HMI Base Module	YES	YES	YES*
	20				

*Communication module or combination of communication adapter mounted on HMI base module

Easy Operation Using The HMI Module

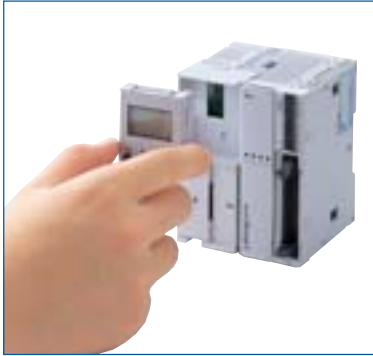

Easy mounting



Ease of operation and compact size

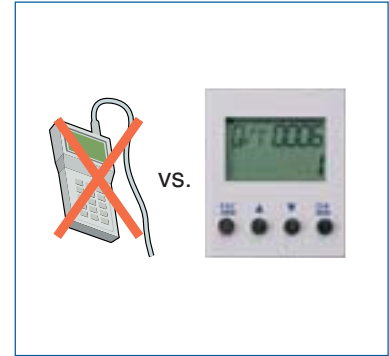

No need for special tools



Recover a system failure immediately by reading the error codes.



Set the time and calendar with optional clock cartridge

The HMI Module allows you to access the following menus

- Timer Menu
- Counter Menu
- Data Register Menu
- Input Menu
- Output Menu
- Internal Relay Menu
- Shift Register Menu
- Error Menu
- Run/Stop Menu
- Calendar Menu
- Clock Menu



Clock Cartridge



Monitor and change the status and setup of your CPU while the system is in operation

Communication Capabilities Expand The Network Of Control Systems

Serial Communication Functions

Data Link System

(The Data Link System is not available for the All-in-One 10 I/O module)

OpenNet Controller (Master) and MicroSmart (Slave)

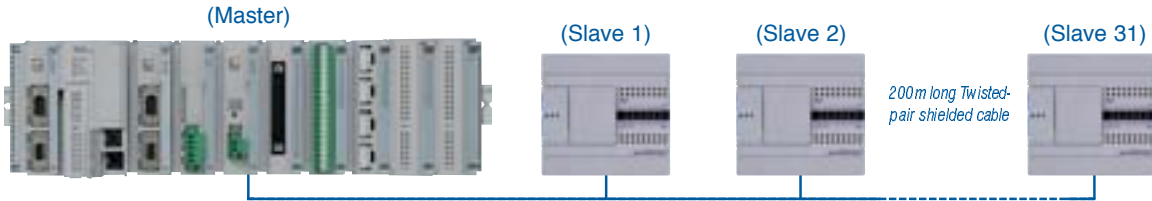

Establishes a data link system using the OpenNet Controller as a master and a maximum of 31 MicroSmart CPU modules as slaves. Distributed control on an RS485 network is made possible without the need for communication programs. (RS485 communication adapter is required to set up a data link system.)

MicroSmart (Master) and MicroSmart (Slave)



Distributed MicroSmart CPU modules at each processing stage can be controlled as one integrated system without a host. One MicroSmart as a master interface with up to 31 MicroSmart modules on an RS485 network without the need for communication programs. (RS485 communication adapter is required to set up a data link system.)

Computer Link System (1:N)

MicroSmart (Master) and MicroSmart (Slave)

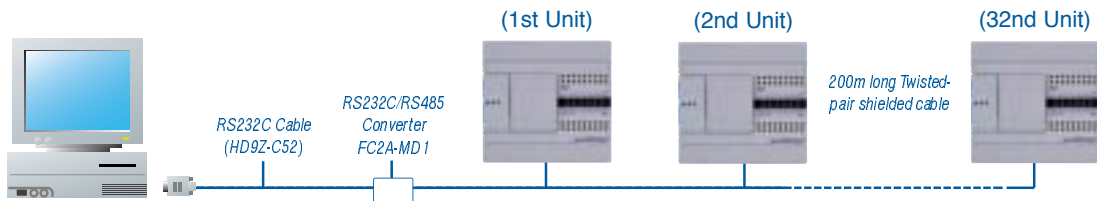

Up to 32 MicroSmart modules can be connected to a PC. The values of timers and counters, data of data registers, and I/O status can be monitored on the PC. Also, user programs can be downloaded to the MicroSmart to establish a total supervisory system. (RS485 communication adapter is required to set up a 1:N computer link system.)

Connecting to Operator Interface

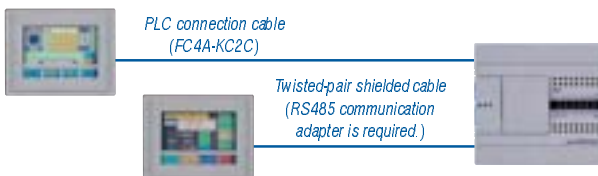

The MicroSmart can be connected to IDEC's HG series Operator Interface. The HG series can exchange data with each device in the MicroSmart. Also, the HG can graphically display the values of timers and counters, data of data register, and I/O status.

Windows Compatible Programming Software

WindLDR[®] for Windows

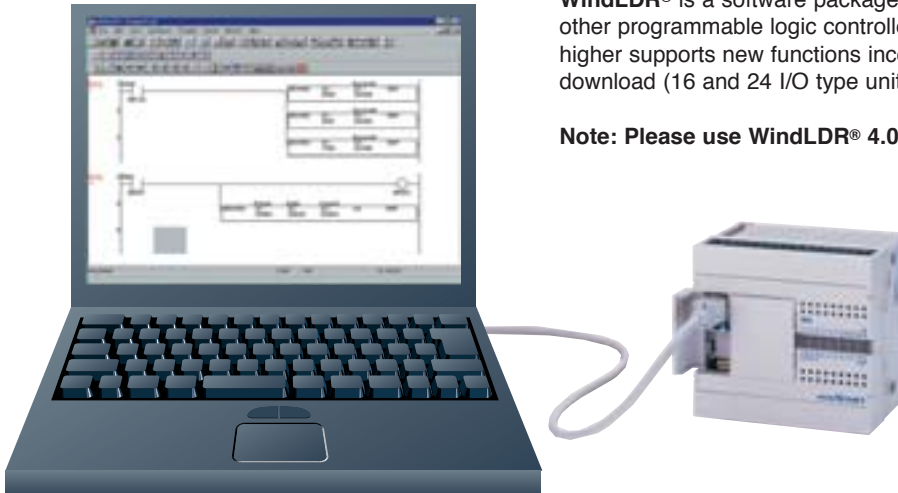

WindLDR[®] is a software package to program the MicroSmart and all of IDEC's other programmable logic controllers. Upgraded WindLDR[®] version 4.0 or higher supports new functions incorporated in the MicroSmart, such as partial download (16 and 24 I/O type units only) and comment download functions.

Note: Please use WindLDR[®] 4.0 or higher for programming MicroSmart.

System Requirements

OS: Windows 2000, Windows 98, Windows 95, Windows NT4.0 (Service Pack 3 or higher)

CPU: Pentium 75MHz or higher

Memory: 24MB of available RAM on Windows 95 and Windows 98, 32MB of available RAM on Windows NT

HD: 20MB of available hard-disk space

The WindLDR[®] modem communication function cannot be used on Windows 95.

1. Improved Operation of the Ladder Program Editor



The right power rail can be fixed. When a program line exceeds the right power rail, a connection line is automatically inserted. Also, the ladder program can be printed out with a fixed power rail for clear viewing.

2. Cache Function in Ladder to Mnemonic Conversion

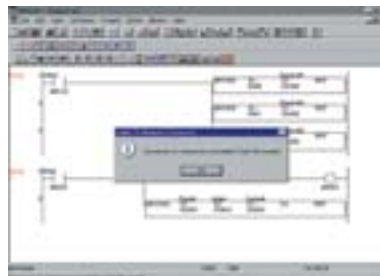

When a user program is modified, WindLDR[®] 4.0 or higher converts only the modified portion of the program, saving conversion time when modification and downloading are repeated during debugging.

3. Comment Download Function



The MicroSmart can store comments attached to the user program. Since a user program can be downloaded to the MicroSmart with comments attached to operands and rungs, the recorded comments can be restored from the MicroSmart without a ladder file. This function is also available on the OpenNet Controller.

4. Modem Communication



WindLDR[®] can supervise operation and collect data from a remote PLC via modem and phone line. Control possibilities can be expanded by using the modem control function of the MicroSmart or OpenNet Controller.

5. Cover Page



A cover page editor is provided to record the program name and creation date. The cover page stores information on each user program to help archive many user programs.

MICROSmart Product Selection List

The Next Generation of PLC

- Compact CPU modules available in All-in One or Slim types with 10, 16, 20, 24, or 40 I/O
- DC Input, Relay Output, Transistor Output, Combination I/O and Analog I/O expansion modules
- 24 I/O All-in-One CPU expandable to 88 I/O points; 20 I/O slim types expandable up to 148 or 244 I/O; 40 I/O slim type expandable up to 264 I/O
- Standard RS232 port, optional plug-in RS485/RS232 port
- Optional memory cartridge or real-time clock and calendar cartridge
- UL listed for hazardous locations



CPU Modules (All-in-One Type)

Power Voltage	Input Type	Output Type	I/O Points	Part No.
100-240V AC 50/60 Hz	24V DC (Sink/Source)	Relay Output 240V AC/30V DC, 2A	10-I/O Type (6 in / 4 out)	FC4A-C10R2
			16-I/O Type (9 in / 7 out)	FC4A-C16R2
			24-I/O Type (14 in / 10 out)	FC4A-C24R2

CPU Modules (Slim Type)

Power Voltage	Input Type	Output Type	High-speed Transistor Output	I/O Points	Part No.
24V DC	24V DC (Sink/Source)	Transistor Sink Output 0.3A	Sink Output 0.3A	20 (12 in / 8 out)	FC4A-D20K3
		Transistor Source Output 0.3A			FC4A-D20S3
		Relay Output 240V AC/30V DC, 2A	Source Output 0.3A	20 (12 in / 8 out)*	FC4A-D20RK1
		Transistor Sink Output 0.3A	FC4A-D20RS1		
		Transistor Sink Output 0.3A	Sink Output 0.3A	40 (24 in / 16 out)	FC4A-D40K3
		Transistor Source Output 0.3A			FC4A-D40S3

Note *: Two points are transistor outputs, and six points are relay outputs.

Input Modules

Input Type	Input Points	Terminal	Part No.
24V DC (Sink/Source)	8 points	Removable Terminal Block	FC4A-N08B1
	16 points		FC4A-N16B1
	16 points	MIL Connector	FC4A-N16B3
	32 points		FC4A-N32B3

Output Modules

Output Type	Output Points	Terminal	Part No.
Relay Output 240V AC/30V DC, 2A	8 points	Removable Terminal Block	FC4A-R081
	16 points		FC4A-R161
Transistor Sink Output 0.3A	8 points	Removable Terminal Block	FC4A-T08K1
			FC4A-T08S1
Transistor Sink Output 0.1A	16 points	MIL Connector	FC4A-T16K3
			Transistor Source Output 0.1A
Transistor Sink Output 0.1A	32 points		FC4A-T32K3
			Transistor Source Output 0.1A

Combination I/O Modules

Input Type	Output Type	I/O Points	Terminal	Part No.
24V DC (Sink/Source)	Relay Output 240V AC/30V DC, 2A	8 (4 in / 4 out)	Removable Terminal Block	FC4A-M08BR1
		24 (16 in / 8 out)	Non-removable Terminal Block	FC4A-M24BR2

Analog I/O Modules

Name	Input Type	Output Type	I/O Points	Terminal	Part No.
Analog I/O Module	Voltage (0-10V DC) Current (4-20mA)	Voltage (0-10V DC) Current (4-20mA)	2 inputs 1 output	Removable Terminal Block	FC4A-L03A1
	Thermocouple Resistance thermometer				FC4A-L03AP1
Analog Input Module	Voltage (0-10V DC) Current (4-20mA)	-	2 inputs		FC4A-J2A1
Analog Output Module	-	Voltage (0-10V DC) Current (4-20mA)	1 output		FC4A-K1A1

HMI Module

Name	Description	Part No.
HMI Module	For displaying and changing required operands	FC4A-PH1
HMI Base Module	For mounting HMI module with slim type CPU module	FC4A-HPH1

Programming Software

Name	Part No.
Programming and Monitoring Software [WindLDR Ver.4.*]	FC9Y-LP2CDW

For Slim Type CPU Module

Name	Description	Part No.
RS232C Communication Module	Mini DIN connector type for slim type CPU module	FC4A-HPC1
RS485 Communication Module	Mini DIN connector type for slim type CPU module	FC4A-HPC2
	Terminal block type for slim type CPU module	FC4A-HPC3

MICROSmart Product Selection List Cont. / Specifications

Miscellaneous Accessories		Part No.
Communication Adapter	RS232C, Mini DIN	FC4A-PC1
	RS485, Mini DIN	FC4A-PC2
	RS485, Screw terminal Type	FC4A-PC3
Clock Cartridge		FC4A-PT1
Memory Cartridge (32KB)		FC4A-PM32
Memory Cartridge (64KB)		FC4A-PM64
RS232C/RS485 Converter		FC2A-MD1
MIL Connector Breakout Modules	20 pt. Module	BX1D-S20A
	26 pt. Module	BX1D-S26A
MIL Connector Socket	20 wire for I/O Modules	FC4A-PMC20P
	26 wire for CPU I/O	FC4A-PMC26P
I/O Terminal Blocks (package qty 2)	10 pt. Block	FC4A-PMT10P
	11 pt. Block	FC4A-PMT11P
	13 pt. Block	FC4A-PMT13P
	16 pt. Block	FC4A-PMTK16P FC4A-PMTS16P
Analog Voltage Input Cable (1m/3.28 ft. long)		FC4A-PMAC2P
Direct Mounting Strips		FC4A-PSP1P
35mm Aluminum DIN Rails (1.5m/3.28 ft. long)		BAA1000 BNDN1000
Mounting Clips		BNL6

Cable Accessories			Part No.	
Programming Cable, CPU to PLC RS232 (3m)			FC2A-KC4C	
User Communication Cable, RS232 (2.4m)			FC2A-KP1C	
Combo Prog./User Comm. Cable, port 1 only (3m)			FC4A-KC4C	
Modem Cable, PLC to Modem RS232 (3m)			FC2A-KM1C	
O/I Communication Cable for HG Series RS232 (5m)			FC4A-KC1CA	
O/I Communication Cable for HG2F, port 1 only (5m)			FC4A-KC2CA	
I/O Cables for MIL Connector	16pt. and 32pt. I/O Modules 20-wire	Non-shielded	0.5m	FC9Z-H050B20
			1m	FC9Z-H100B20
			2m	FC9Z-H200B20
		Shielded	3m	FC9Z-H300B20
			0.5m	FC9Z-H050A20
			1m	FC9Z-H100A20
	Shielded w/Single wire Connectors	2m	FC9Z-H200A20	
		3m	FC9Z-H300A20	
	20pt. and 40pt. CPU Modules 26-wire	Non-shielded	1.52m	FC9Z-H100C20A
			0.5m	FC9Z-H050B26
			1m	FC9Z-H100B26
		Shielded	2m	FC9Z-H200B26
			3m	FC9Z-H300B26
			0.5m	FC9Z-H050A26
Shielded w/Single wire Connectors	1m	FC9Z-H100A26		
	2m	FC9Z-H200A26		
		3m	FC9Z-H300A26	
		1.52m	FC9Z-H100C26A	

CPU General Specifications

Part No.	FC4A-C10R2	FC4A-C16R2	FC4A-C24R2	FC4A-D20K3 FC4A-D20S3	FC4A-D20RK1 FC4A-D20RS1	FC4A-D40K3 FC4A-D40S3
Type	All-in-one Type CPU Module			Slim Type CPU Module		
Rated Power Voltage	100 to 240V AC			24V DC		
Allowable Voltage Range	85 to 264V AC			20.4 to 26.4V DC (including ripple)		
Rated Power Frequency	50/60Hz (47 to 63Hz)			-		
Maximum Input Current	0.25A (85V AC)	0.30A (85V AC)	0.45A (85V AC) ^{*2}	0.56A (26.4V DC) ^{*3}	0.70A (26.4V DC) ^{*3}	
Maximum Power Consumption	30VA/264V AC ^{*1} 20VA/100V AC	31VA/264V AC ^{*1} 22VA/100V AC	40VA/264V AC ^{*2} 33VA/100V AC	15W/26.4V DC ^{*3}	19W/26.4V DC ^{*3}	
Allowable Momentary Power Interruption	20 msec (at the rated inputs and outputs)			10 msec (at 24V DC)		
Dielectric Strength	Between power and ⊕ terminals: 1500V AC, 1 minute			Between power and ⊕ terminals: 500V AC, 1 minute		
	Between I/O and ⊕ terminals: 1500V AC, 1 minute			Between I/O and ⊕ terminals: 1500V AC, 1 minute		
Insulation Resistance (500V DC megger)	Between power and ⊕ terminals: 10 MΩ minimum			Between power and ⊕ terminals: 10 MΩ minimum		
	Between I/O and ⊕ terminals: 10 MΩ minimum			Between I/O and ⊕ terminals: 10 MΩ minimum		
Noise Resistance	AC power terminals: 1.5 kV, 50 nsec to 1 μsec I/O terminals (coupling clamp): 1.5 kV, 50 nsec to 1 μsec			DC power terminals: 1.0 kV, 50 nsec to 1 μsec I/O terminals (coupling clamp): 1.5 kV, 50 nsec to 1 μsec		
Inrush Current	35A maximum	35A maximum	40A maximum	50A maximum (24V DC)		
Power Supply Wire	UL1015 AWG22, UL1007 AWG18					
Operating Temperature	0 to 55°C					
Storage Temperature	-25 to +70°C					
Relative Humidity	Level RH1, 30 to 95% (non-condensing)					
Altitude	Operation: 0 to 2,000m (0 to 6,565 feet) Transport: 0 to 3,000m (0 to 9,840 feet)					
Pollution Degree	2 (IEC 60664)					
Corrosion Immunity	Free from corrosive gases					
Degree of Protection	IP20					
Grounding Wire	UL1007 AWG16			UL1015 AWG22, UL1007 AWG18		
Vibration Resistance	DIN rail mounted	10 to 57 Hz amplitude 0.075 mm, 57 to 150 Hz acceleration 9.8 m/sec ² (1G) 2 hours in each of 3 axes				
	Direct mounted	2 to 25 Hz amplitude 1.6 mm, 25 to 100 Hz acceleration 39.2 m/sec ² (4G) 90 minutes in each of 3 axes				
Shock Resistance	147 m/sec ² (15G), 11 msec duration, 3 shocks per axis, on three mutually perpendicular axes (IEC 61131)					
Weight	230g	250g	305g	140g	185g	180g

^{*1} The CPU module power consumption includes 250 mA sensor power

^{*2} CPU module (including 250 mA sensor power) + 4 I/O modules

^{*3} CPU module + 7 I/O modules

Specifications Cont.

CPU Function Specifications

Part No.	FC4A-C10R2	FC4A-C16R2	FC4A-C24R2	FC4A-D20K3 FC4A-D20S3	FC4A-D20RK1 FC4A-D20RS1	FC4A-D40K3 FC4A-D40S3		
Control System	Stored program system							
Instruction Words	35 basic							
Program Capacity *4	4,800 bytes (800 steps)	15,000 bytes (2,500 steps)	27,000 bytes (4,500 steps)	27,000 bytes (4,500 steps)	31,200 bytes (5,200 steps)			
User Program Storage	EEPROM							
Processing Time	1.65 msec (1000 steps)							
Expandable I/O Modules	0.64 msec							
I/O Points	Input	6	9	14	Expansion: 12	Expansion: 12	Expansion: 24	Expansion: 24
	Output	4	7	10	Expansion: 64	Expansion: 8	Expansion: 128	Expansion: 16
Internal Relay	256	1024						
Shift Register	64	128						
Data Register	400	1300						
Expansion Data Register	-					6000		
Counter	32	100						
Timer(1-sec, 100-msec, 10-msec, 1-msec)	32	100						
RAM Backup	Backup Duration	Approx. 30 days (typical) at 25°C after backup battery fully charged						
	Backup Data	Internal relay, shift register, counter, data register, expansion data register						
	Battery	Lithium secondary battery						
	Charging Time	Approx. 15 hours for charging from 0% to 90% of full charge						
	Battery Life	5 years when charging for 9 hours and discharging for 15 hours						
	Replaceability	Impossible to replace battery						
Self-diagnostic Function	Power failure, watchdog timer, data link connection, user program EEPROM sum check, timer/counter preset value sum check, user program RAM sum check, keep data, user program syntax, user program writing, CPU module, clock IC, I/O bus initialize, user program execution							
Input Filter	3 to 15 msec (1-msec increments)							
Catch Input/Interrupt Input	Four Inputs (I2 through I5)		Minimum turn on pulse width: 40 μsec maximum		Minimum turn off pulse width: 150 μsec maximum			
High-speed Counter	Maximum Counting Frequency and High-speed Counter Points	Total 4 points Single/two-phase selectable: 20 kHz (1 point) Single-phase: 5 kHz (3 points)		Total 4 points Single/two-phase selectable: 20 kHz (2 points) Single-phase: 5 kHz (2 points)				
	Counting Range	0 to 65535 (16 bits)						
	Operation Mode	Rotary encoder mode and adding counter mode						
Analog Potentiometer	Quantity	1 point	2 points	1 point				
	Data Range	0 to 255						
Analog Voltage Input	Quantity				1 point			
	Input Voltage Range				0 to 10V DC			
	Input Impedance				Approx. 100 kΩ			
	Data Range				0 to 255 (8 bit)			
Pulse Output	Quantity				2 points			
	Maximum Frequency				20 kHz			
Sensor Power Supply	Output Voltage/Current	24V DC (+10% to -15%), 250 mA						
	Overload Detection	Not available						
	Isolation	Isolated from the internal circuit						
Port 1	RS232C Maintenance Communication, User Communication							
Port 2 / Communication Adapter (option) *6	-	Possible	Possible	Possible	Possible	Possible		
Clock Cartridge (Option)	Possible	Possible	Possible	Possible	Possible	Possible		
Memory Cartridge (Option)	Possible	Possible	Possible	Possible	Possible	Possible		
HMI Module (Option)	Possible	Possible	Possible	Possible	Possible	Possible		

Communication Port (RS232C Port 1)

Type	All-in-one Type	Slim Type
Standards	EIA RS232C	
Maximum Baud Rate	19200 bps	
Maintenance Communication	Possible	
User Communication	Possible	
Modem Communication	Impossible	
Data Link Communication	Impossible	
Cable	Special Cable *7	
Isolation between Internal Circuit and Communication Port	Not isolated	

*4 1 step equals 6 bytes

*5 Not including expansion I/O service, clock function processing, data link processing, and interrupt processing

*6 RS232C: Maintenance Communication, User Communication, Modem Communication

RS485: Maintenance Communication, Data Link

*7 FC2A-KC4C, FC2A-KP1C, FC4A-KC1C, FC4A-KC2C

Specifications Cont.

DC Input Specifications

Part No.	FC4A-C10R2	FC4A-C16R2	FC4A-C24R2	FC4A-D20K3 FC4A-D20S3	FC4A-D20RK1 FC4A-D20RS1	FC4A-D40K3 FC4A-D40S3
Rated Input Voltage	24V DC sink/source input signal					
Input Voltage Range	20.4 to 28.8V DC			20.4 to 26.4V DC		
Rated Input Current	I0 and I1: 11 mA I2 to I7, I10 to I15: 7 mA/point (24V DC)			I0, I1, I6, I7: 5 mA/point (24V DC) I2 to I5, I10 to I27: 7 mA/point (24V DC)		
Input Impedance	I0 and I1: 2.1 kΩ I2 to I7, I10 to I15: 3.4 kΩ			I0, I1, I6, I7: 5.7 kΩ I2 to I5, I10 to I27: 3.4 kΩ		
Turn ON Time	I0 to I5: 35 μsec + filter value I6, I7, I10 to I15: 40 μsec + filter value			I0 to I7: 35 μsec + filter value I10 to I27: 40 μsec + filter value		
Turn OFF Time	I0 and I1: 45 μsec + filter value I2 to I7, I10 to I15: 150 μsec + filter value			I0, I1, I6, I7: 45 μsec + filter value I2 to I5, I10 to I27: 150 μsec + filter value		
Input Points	6 (6/1 common)	9 (9/1 common)	14 (14/1 common)	12 (12/1 common)	12 (12/1 common)	24 (12/1 common)
Connector	On Mother Board	-		FL26A2MA (Oki Electric Cable)	MC1.5/13-G-3.81BK (Phoenix Contact)	FL26A2MA (Oki Electric Cable)
	Insertion/Removal Durability	-		100 times minimum		
Isolation	Between input terminals	Not isolated				
	Internal circuit	Photocoupler isolated				
Input Type	Type1 (IEC61131)					
External Load for I/O Interconnection	Not needed					
Signal Determination Method	Static					
Effect of Improper Input Connection	Both sinking and sourcing input signals can be connected. If any input exceeding the rated value is applied, permanent damage may be caused.					
Cable Length	3m (9.84 ft.)					

Transistor Sink and Source Output Specifications

Part No.	FC4A-D20K3 FC4A-D20S3	FC4A-D20RK1 FC4A-D20RS1	FC4A-D40K3 FC4A-D40S3
Output Points and Common Line	8 (8/1 common)	2 (2/1 common)	16 (8/1 common)
Output Type	FC4A-D20K3/D20RK1/D40K3: Sink output FC4A-D20S3/D20RS1/D40S3: Source output		
Rated Load Voltage	24V DC		
Operating Load Voltage Range	20.4 to 28.8V DC		
Rated Load Current	0.3A per output point		
Maximum Load Current	1A per common line		
Voltage Drop (ON Voltage)	1V maximum (voltage between COM and output terminals when output is on)		
Inrush Current	1A maximum		
Leakage Current	0.1 mA maximum		
Clamping Voltage	39V±1V		
Maximum Lamp Load	8W		
Inductive Load	L/R = 10 ms (28.8V DC, 1Hz)		
External Current Draw	100mA maximum, 24V DC (power voltage at the +V or -V terminal)		
Isolation	Between output terminal and internal circuit	Photocoupler isolated	
	Between output terminals	Not isolated	
Connector	On Mother Board	FL26A2MA (Oki Electric Cable)	MC1.5/16-G-3.81BK (Phoenix Contact)
	Insertion/Removal Durability	100 times minimum	
Output Delay	Turn ON time	5μs (Q0,Q1), 300μs max (Q2 to Q7, Q10 to Q17)	
	Turn OFF time	5μs (Q0,Q1), 300μs max (Q2 to Q7, Q10 to Q17)	

Relay Output Specifications

Part No.	FC4A-C10R2	FC4A-C16R2	FC4A-C24R2	FC4A-D20RK1 FC4A-D20RS1
No. of Outputs	4	7	10	8
Output Points per Common Line	COM0	3	4	4
	COM1	1	2	4
	COM2	-	1	1
	COM3	-	-	1
Output Type	1NO			
Maximum Load Current	2A per point			
	8A per common line			
Minimum Switching Load	0.1 mA/0.1V DC (reference value)			
Initial Contact Resistance	30 mΩ maximum			
Electrical Life	100,000 operations minimum (rated load 1,800 operations/hour)			
Mechanical Life	20,000,000 operations minimum (no load 18,000 operations/hour)			
Rated Load (resistive/inductive)	240V AC/2A, 30V DC/2A			
Dielectric Strength	Between output and ⊕ terminals	1,500V AC, 1 minute		
	Between output terminal and internal circuit	1,500V AC, 1 minute		
	Between output terminals (COMs)	1,500V AC, 1 minute		
Connector	On Mother Board	-		*9
	Insertion/Removal Durability	-		100 times minimum

*9 MC1.5/16-G-3.81BK (Phoenix Contact)

Specifications Cont.

I/O Usage Limits

(All-in-one Type)

FC4A-C10R2

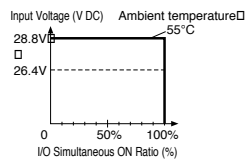

FC4A-C16R2

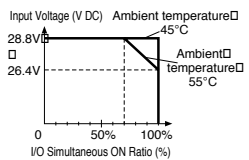

FC4A-C24R2

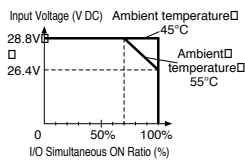

(Slim Type)

FC4A-D20K3/D20S3

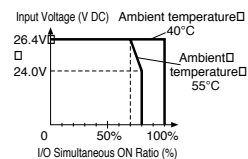

FC4A-D20RK1/D20RS1

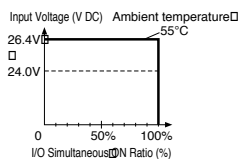

FC4A-D40K3/D40S3

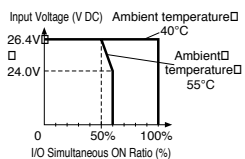

Warning

- When using at an operating ambient temperature above 40°C, reduce the input voltage or the quantity of I/O points that turn on simultaneously.

Input Internal Circuit

(All-in-one Type)

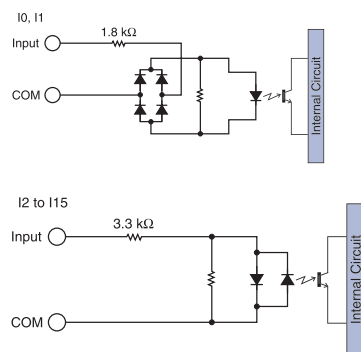

(Slim Type)

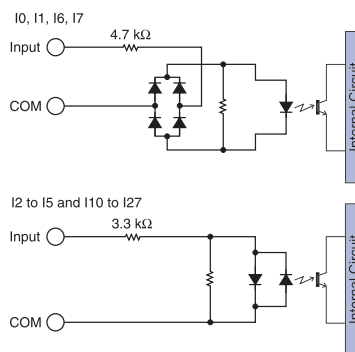

Output Internal Circuit

(Slim Type)

• Sink Output

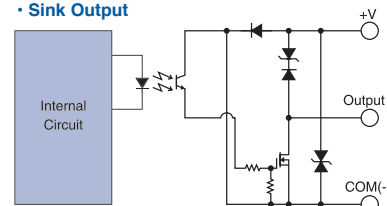

• Source Output

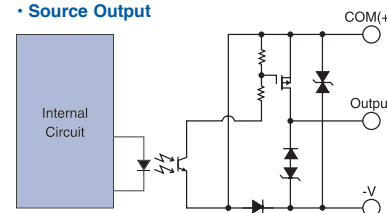

Communication Adapter and Communication Module Specifications

Part No.	FC4A-PC1 FC4A-HPC1	FC4A-PC2 FC4A-HPC2	FC4A-PC3 FC4A-HPC3
Standards	EIA RS232C	EIA RS485	EIA RS485
Maximum Baud Rate	19200 bps	19200 bps	Computer link: 19,200 bps Data link: 38,400 bps
Maintenance Comm.	Possible	Possible	Possible
User Comm.	Possible	N/A	N/A
Modem Comm.	Possible	N/A	N/A
Data Link Comm.	N/A	N/A	Possible
Max Cable Length	Special cable *10	Special cable *11	200m
No. of Slave Stations	-	-	31
Isolation between Internal Circuit and Communication Port	Not isolated		
Recommended Cable for RS485	Twisted-pair shielded cable with a minimum core wire of 0.3 mm ²		
Conductor Resistance	85 Ω/km maximum		
Shield Resistance	20 Ω/km maximum		

*10 FC2A-KC4C, FC2A-KM1C, FC4A-KC1C, FC4A-KC2C

*11 FC2A-KP1C

HMI Module Specifications (Option)

Part No.	FC4A-PH1
Power Voltage	5V DC (supplied from the CPU module)
Weight	20g

Memory Cartridge Specifications (Option)

Part No.	FC4A-PM32	FC4A-PM64
Memory Type	EEPROM	EEPROM
Memory Capacity	32 KB	64 KB
Storage Hardware	CPU module	CPU module
Storage Software	WindLDR	WindLDR
Program Storage	One user program can be stored on one memory cartridge.	

Clock Cartridge Specifications (Option)

Part No.	FC4A-PT1
Accuracy	±30 sec/month (typical) at 25°C
Backup Duration	Approx. 30 days (typical) at 25°C after backup battery fully charged
Battery	Lithium secondary batt (non replaceable)
Charging Time	Approx. 10 hours for charging from 0% to 90% of full charge

Specifications Cont.

Specifications (Expansion I/O Module)

DC Input Module Specifications

Part No.	FC4A-N08B1	FC4A-N16B1	FC4A-N16B3	FC4A-N32B3	
Input Points	8 (8/1 common)	16 (16/1 common)		32 (16/1 common)	
Rated Input Voltage	24V DC sink/source input signal				
Input Voltage Range	20.4 to 28.8V DC				
Rated Input Current	7 mA/point (24V DC)		5 mA/point (24V DC)		
Input Impedance	3.4 kΩ		4.4 kΩ		
Turn ON Time (24V DC)	4 msec				
Turn OFF Time (24V DC)	4 msec				
Isolation	Between input terminals: Not isolated Internal circuit: Photocoupler isolated				
External Load for I/O Interconnection	Not needed				
Signal Determination	Static				
Effect of Improper Input Connection	Both sinking and sourcing input signals can be connected. If any input exceeding the rated value is applied, permanent damage may be caused.				
Cable Length	3m (9.84 ft.) in compliance with electromagnetic immunity				
Connector	on Mother Board	MC1.5/10-G-3.81BK (Phoenix Contact)	FL20A2MA (Ok Electric Cable)		
	Insert/Remove Durability	100 times minimum			
Internal Current Draw	All Inputs ON	25 mA (5V DC) 0 mA (24V DC)	40 mA (5V DC) 0 mA (24V DC)	35 mA (5V DC) 0 mA (24V DC)	65 mA (5V DC) 0 mA (24V DC)
	All Inputs OFF	5 mA (5V DC) 0 mA (24V DC)	5 mA (5V DC) 0 mA (24V DC)	5 mA (5V DC) 0 mA (24V DC)	10 mA (5V DC) 0 mA (24V DC)
Weight	85g	100g	65g	100g	

Transistor Output Module Specifications

Part No.	FC4A-T08K1 FC4A-T08S1	FC4A-T16K3 FC4A-T16S3	FC4A-T32K3 FC4A-T32S3	
Output/Common Lines	8 (8/1 common)	16 (16/1 common)	32 (16/1 common)	
Output Type	FC4A-T□K□: Transistor sink output FC4A-T□S□: Transistor source output			
Rated Load Voltage	24V DC			
Oper. Load Volt. Range	20.4 to 28.8V DC			
Rated Load Current	0.3A/output pt. (@ 28.8V DC) / 0.1A/output pt. (@ 28.8V DC)			
Maximum Load Current	0.36A (@ 28.8V DC) / 0.12A (@ 28.8V DC)			
Voltage Drop (ON)	1V max (voltage between COM & output terminals - output on)			
Inrush Current	1A maximum			
Leakage Current	0.1 mA maximum			
Clamping Voltage	39V±1V			
Maximum Lamp Load	8W			
Inductive Load	L/R = 10 msec (28.8V DC, 1Hz)			
External Current Draw	FC4A-T□K□: 100 mA max, 24V DC (power voltage at +V) FC4A-T□S□: 100 mA max, 24V DC (power voltage at -V)			
Isolation	Between output terminal and internal circuit: Photocoupler isolated Between output terminals: Not isolated			
Connector	on Mother Board	MC1.5/10-G-3.81BK (Phoenix Contact)	FL20A2MA (Ok Electric Cable)	
	Insert/Remove Durability	100 times minimum		
Internal Current Draw	All Inputs ON	10 mA (5V DC) 20 mA (24V DC)	10 mA (5V DC) 40 mA (24V DC)	20 mA (5V DC) 70 mA (24V DC)
	All Inputs OFF	5 mA (5V DC) 0 mA (24V DC)	5 mA (5V DC) 0 mA (24V DC)	10 mA (5V DC) 0 mA (24V DC)
Output Delay	Turn ON time	300 μsec maximum		
	Turn OFF time	300 μsec maximum		
Weight	85g	70g	105g	

Relay Output Module Specifications

Part No.	FC4A-R081	FC4A-R161	
Outputs/Common Lines	8 (4/1 common)	16 (8/1 common)	
Output Type	1NO		
Maximum Load Current	2A		
Min. Switching Load	0.1 mA/0.1V DC (reference value)		
Contact Resistance	30 mΩ maximum		
Electrical Life	100,000 operations min. (rated load 1,800 operations/hour)		
Mechanical Life	20,000,000 operations min. (no load 18,000 operations/hour)		
Rated Load (resistive/inductive)	240V AC/2A, 30V DC/2A		
Dielectric Strength	Between output and ⊕ or ⊖ terminals: 1,500V AC, 1 min.		
	Between output term. and internal circuit: 1,500V AC, 1 min.		
	Between output term. (COMs): 1,500V AC, 1 min.		
Connector	on Mother Board	MC1.5/11-G-3.81BK (Phoenix Contact)	MC1.5/10-G-3.81BK (Phoenix Contact)
	Insert/Remove Durability	100 times minimum	
Internal Current Draw	All Inputs ON	30 mA (5V DC) 40 mA (24V DC)	45 mA (5V DC) 75 mA (24V DC)
	All Inputs OFF	5 mA (5V DC) 0 mA (24V DC)	5 mA (5V DC) 0 mA (24V DC)
Weight	110g	145g	

Combination I/O Module Specifications

Part No.	FC4A-M08BR1	FC4A-M24BR2	
DC Input Specifications	Input Points	4 (4/1 common)	16 (16/1 common)
	Rated Input Voltage	24V DC sink/source input signal	
	Input Voltage Range	20.4 to 28.8V DC	
	Rated Input Current	7 mA/point (24V DC)	
	Input Impedance	3.4 kΩ	
	Turn ON Time	4 msec (24V DC)	
	Turn OFF Time	4 msec (24V DC)	
	Isolation	Between input terminals: Not isolated Internal circuit: Photocoupler isolated	
	External Load for I/O Interconnection	Not needed	
	Signal Determination	Static	
Effect of Improper Input Connection	Both sinking and sourcing input signals can be connected. If any input exceeding the rated value is applied, permanent damage may be caused.		
Cable Length	3m (9.84 ft.) in compliance with electromagnetic immunity		
Relay Output Specifications	Output Points	4 (4/1 common)	8 (4/1 common)
	Output Type	1NO	
	Maximum Load Current	2A	
	Min. Switching Load	0.1 mA/0.1V DC (reference value)	
	Contact Resistance	30 mΩ maximum	
	Electrical Life	100,000 operations min. (rated load 1,800 operations/hour)	
	Mechanical Life	20,000,000 operations min. (no load 18,000 operations/hour)	
	Rated Load (resistive/inductive)	240V AC/2A, 30V DC/2A	
	Dielectric Strength	Between out and ⊕ or ⊖ terminals: 1,500V AC, 1 minute	
		Between out terminal and internal circuit: 1,500V AC, 1 minute Between out terminal (COMs): 1,500V AC, 1 minute	
Connector	on Mother Board	MC1.5/11-G-3.81BK (Phoenix Contact)	Input: F6018-17P (Fujicon) Output: F6018-11P (Fujicon)
	Insert/Remove Durability	100 times minimum	
Internal Current Draw	All Inputs ON	25 mA (5V DC) 20 mA (24V DC)	65 mA (5V DC) 45 mA (24V DC)
	All Inputs OFF	5 mA (5V DC) 0 mA (24V DC)	10 mA (5V DC) 0 mA (24V DC)
Weight	95g	140g	

Specifications Cont.

Input Usage Limits

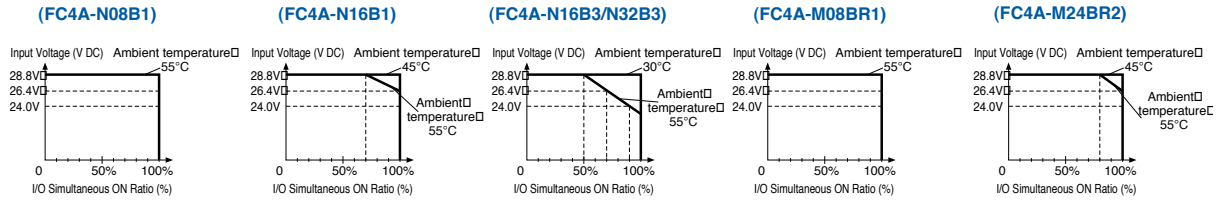

Input Internal Circuit

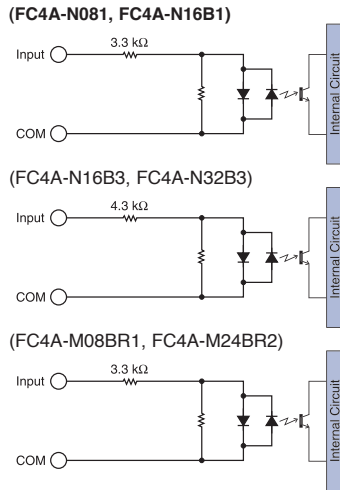

Output Internal Circuit

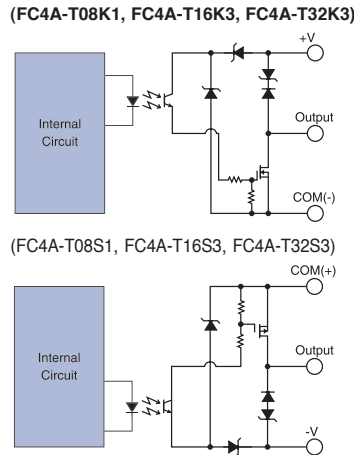

Warning

- When using at an operating ambient temperature above 40°C, reduce the input voltage or the quantity of I/O points that turn on simultaneously.

Specifications (Analog I/O Module)

Analog I/O Module Specifications

Part No.	FC4A-L03A1	FC4A-L03AP1	FC4A-J2A1	FC4A-K1A1
Input Points	2	2	2	-
Input Signal Type	Voltage (0 to 10V DC) Current (4 to 20 mA DC)	Thermocouple Resistance Thermometer	Voltage (0 to 10V DC) Current (4 to 20 mA DC)	-
Output Points	1	1	-	1
Output Signal Type	Voltage (0 to 10V DC) Current (4 to 20 mA DC)	Voltage (0 to 10V DC) Current (4 to 20 mA DC)	-	Voltage (0 to 10V DC) Current (4 to 20 mA DC)
Rated Power Voltage	24V DC			
Allowable Voltage Range	20.4 to 28.8V DC			
Connector	MC1.5/11-G-3.81BK (Phoenix Contact)			
Insert/Remove Durability	100 times minimum			
Internal Current Draw	Internal Power	50 mA (5V DC) 0 mA (24V DC)	50 mA (5V DC) 0 mA (24V DC)	50 mA (5V DC) 0 mA (24V DC)
	External Power	40 mA (24V DC)	40 mA (24V DC)	40 mA (24V DC)
Weight	85g			

Input Circuit

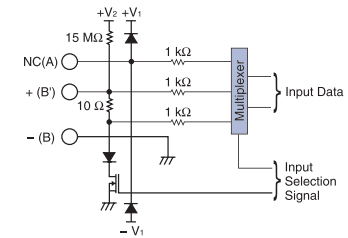

Output Circuit

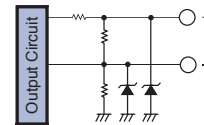

Analog Input Specifications

Part No.	FC4A-L03A1, FC4A-J2A1, FC4A-L03AP1		FC4A-L03AP1 only	
	Voltage Input	Current Input	Resistance Thermometer	Thermocouple
Input Signal Type	Voltage Input	Current Input	Resistance Thermometer	Thermocouple
Input Range	0 to 10V DC	4 to 20 mA DC	Pt 100 3-wire type (-100 to 500°C)	Type K (0 to 1300°C) Type J (0 to 1200°C) Type T (0 to 400°C)
Input Impedance	1 MΩ minimum	10Ω	1 MΩ minimum	1 MΩ minimum
Allowable Conductor Resistance	-	-	200Ω maximum	-
Input Detection Current	-	-	1.0 mA maximum	-
Sample Duration Time	16 msec maximum		50 msec maximum	
Sample Repetition Time	16 msec maximum		50 msec maximum	
Total Input System Transfer Time	32 msec + 1 scan time (Note 1)		100 msec + 1 scan time (Note 1)	
Type of Input	Single-ended input		Differential input	

(Continued)

Specifications Cont.

Analog Input Specifications (Continued)

Part No.		FC4A-L03A1, FC4A-J2A1, L03AP1		FC4A-L03AP1 Only	
Input Signal Type		Voltage Input	Current Input	Resistance Thermometer	Thermocouple
Operating Mode		Self-scan			
Conversion Method		$\Sigma\Delta$ type ADC			
Input Error	Maximum Error at 25°C	±0.2% of full scale			±0.2% of full scale plus reference junction compensation accuracy (±4°C maximum)
	Temperature Coefficient	±0.006% of full scale /°C			
	Repeatability after Stabilization Time	±0.5% of full scale			
	Non-linearity	±0.2% of full scale			
	Maximum Error	±1% of full scale			
Data	Digital Resolution	4096 increments (12 bits)			
	Input Value of LSB	2.5 mV	4 μ A	0.15 °C	K: 0.325°C J: 0.300°C T: 0.100°C
	Data Type in Application Program	0 to 4095 (12-bit data) -32768 to 32767 (optional range designation) (Note 2)			
	Monotonicity	Yes			
	Input Data Out of Range	Detectable (Note 3)			
Noise Resistance	Maximum Temporary Deviation during Electrical Noise Tests	±3% maximum when a 500V clamp voltage is applied to the power and I/O wiring (Note 4)			
	Common Mode Characteristics	Common mode reject ratio (CMRR): -50 dB			
	Common Mode Voltage	16V DC			
	Input Filter	No			
	Cable	Twisted pair shielded cable is recommended for improved noise immunity		—	
	Crosstalk	2 LSB maximum			
Dielectric Strength		500V between input and power circuit			
Type of Protection		Photocoupler between input and internal circuit			
Effect of Improper Input Connection		No damage			
Maximum Permanent Allowed Overload (No Damage)		13V DC	40 mA DC	—	
Selection of Analog Input Signal Type		Using software programming			
Method of Input Type Selection		Programming Software Configured			

Note 1: Total input system transfer time = Sample repetition time x 2 + 1 scan time

Note 2: The 12-bit data (0 to 4095) processed in the analog I/O module can be linear-converted to a value between -32768 and 32767. The optional range designation, and analog I/O data minimum and maximum values can be selected using data registers allocated to analog I/O modules.

Note 3: When an error is detected, a corresponding error code is stored to a data register allocated to analog I/O operating status.

Note 4: Accuracy of the resistance thermometer is not assured when noise is applied.

Analog Output Specifications

Part No.		FC4A-L03A1, FC4A-L03AP1, FC4A-K1A1	
Output Signal Type		Voltage Output	Current Output
Output Range		0 to 10V DC	4 to 20 mA DC
Load Impedance		2 k Ω minimum	300 Ω maximum
Applicable Load Type		Resistive load	
Settling Time		20 msec	
Total Output System Transfer Time		20 msec + 1 scan time	
Output Error	Maximum Error at 25°C	±0.2% of full scale	
	Temperature Coefficient	±0.015% of full scale /°C	
	Repeatability after Stabilization Time	±0.5% of full scale	
	Output Voltage Drop	±1% of full scale	—
	Non-linearity	±0.2% of full scale	
	Output Ripple	1 LSB maximum	
	Overshoot	0%	
	Total Error	±1% of full scale	
Data	Digital Resolution	4096 increments (12 bits)	
	Output Value of LSB	2.5 mV	4 μ A
	Data Type in Application Program	0 to 4095 (12-bit data) -32768 to 32767 (optional range designation) (Note 5)	
	Monotonicity	Yes	
Current Loop Open	—	Detectable (Note 6)	
Noise Resistance	Maximum Temporary Deviation during Electrical Noise Tests	±3% maximum when a 500V clamp voltage is applied to the power and I/O wiring	
	Cable	Twisted pair shielded cable is recommended for improved noise immunity	
	Crosstalk	No crosstalk because of 1 channel output	
Dielectric Strength		500V between output and power circuit	
Type of Protection		Photocoupler between output and internal circuit	
Effect of Improper Output Connection		No damage	
Selection of Analog Output Signal Type		Using software programming	
Method of Output Type Selection		Programming Software Configured	

Note 5: The 12-bit data (0 to 4095) processed in the analog I/O module can be linear-converted to a value between -32768 and 32767. The optional range designation, and analog I/O data minimum and maximum values can be selected using data registers allocated to analog I/O modules.

Note 6: When an error is detected, a corresponding error code is stored to a data register allocated to analog I/O operating status.

Programming Instruction Commands

Basic Instruction List

Symbol	Function	Qty of Bytes
LOD	Stores intermediate results and reads contact status	6
LODN	Stores intermediate results and reads inverted contact status	6
OUT	Outputs the result of bit logical operation	6
OUTN	Outputs the inverted result of bit logical operation	6
SET	Sets output, internal relay, or shift register bit	6
RST	Resets output, internal relay, or shift register bit	6
AND	Series connection of NO contact	4
ANDN	Series connection of NC contact	4
OR	Parallel connection of NO contact	4
ORN	Parallel connection of NC contact	4
AND · LOD	Series connection of circuit blocks	5
OR · LOD	Parallel connection of circuit blocks	5
BPS	Saves the result of bit logical operation temporarily	5
BRD	Reads the result of bit logical operation which was saved temporarily	3
BPP	Restores the result of bit logical operation which was saved temporarily	2
TML	Subtracting 1-sec timer (0 to 65535 sec)	4
TIM	Subtracting 100-msec timer (0 to 6553.5 sec)	4
TMH	Subtracting 10-msec timer (0 to 655.35 sec)	4
TMS	Subtracting 1-msec timer (0 to 65.535 sec)	4
CNT	Adding counter (0 to 65535)	4
CDP	Dual pulse reversible counter (0 to 65535)	4
CUD	Up/down selection reversible counter (0 to 65535)	4
CC=	Equal to comparison of counter current value	7
CC≥	Greater than or equal to comparison of counter current value	7
DC=	Equal to comparison of data register value	8
DC≥	Greater than or equal to comparison of data register value	8
SFR	Forward shift register	6
SFRN	Reverse shift register	6
SOTU	Rising-edge differentiation output	5
SOTD	Falling-edge differentiation output	5
JMP	Jumps a designated program area	4
JEND	Ends a jump instruction	4
MCS	Starts a master control	4
MCR	Ends a master control	4
END	Ends a program	2

Advanced Instruction List

Symbol	Function	Qty of Bytes	All-in-One Type			Slim Type		
			FC4A-C10R2	FC4A-C16R2	FC4A-C24R2	FC4A-D20K3 FC4A-D20S3	FC4A-D20RK1 FC4A-D20RS1 FC4A-D40K3 FC4A-D40S3	
NOP	No Operation	2	○	○	○	○	○	
MOV	Move	16	○	○	○	○	○	
MOVN	Move Not	16	○	○	○	○	○	
IMOV	Indirect Move	24-28	○	○	○	○	○	
IMOVN	Indirect Move Not	24-28	○	○	○	○	○	
IBMV	Indirect Bit Move	24	-	-	-	-	○	
IBMVN	Indirect Bit Move Not	24	-	-	-	-	○	
BMOV	Block Move	18	-	-	-	-	○	
CMP=	Compare Equal To	20	○	○	○	○	○	
CMP<>	Compare Unequal To	20	○	○	○	○	○	
CMP<	Compare Less Than	20	○	○	○	○	○	
CMP>	Compare Greater Than	20	○	○	○	○	○	
CMP<=	Compare Less Than or Equal To	20	○	○	○	○	○	
CMP>=	Compare Greater Than or Equal To	20	○	○	○	○	○	
ICMP>=	Interval Compare Greater Than or Equal To	22	-	-	-	-	○	
ADD	Addition	20	○	○	○	○	○	
SUB	Subtraction	20	○	○	○	○	○	
MUL	Multiplication	20	○	○	○	○	○	
DIV	Division	20	○	○	○	○	○	

(Continued)

Programming Instruction Commands Cont.

Advanced Instruction List (continued)

Symbol	Name	Qty of Bytes	All-in-One Type			Slim Type	
			FC4A-C10R2	FC4A-C16R2	FC4A-C24R2	FC4A-D20K3 FC4A-D20S3	FC4A-D20RK1 FC4A-D20RS1 FC4A-D40K3 FC4A-D40S3
ANDW	AND Word	20	○	○	○	○	○
ORW	OR Word	20	○	○	○	○	○
XORW	Exclusive OR Word	20	○	○	○	○	○
SFTL	Shift Left	12	○	○	○	○	○
SFTR	Shift Right	12	○	○	○	○	○
BCDLS	BCD Left Shift	14	–	–	–	–	○
WSFT	Word Shift	18	–	–	–	–	○
ROTL	Rotate Left	12	○	○	○	○	○
ROTR	Rotate Right	12	○	○	○	○	○
HTOB	Hex to BCD	14	*	*	*	○	○
HTOA	Hex to ASCII	18	*	*	*	○	○
BTOH	BCD to Hex	14	*	*	*	○	○
BTOA	BCD to ASCII	18	*	*	*	○	○
ATOH	ASCII to Hex	18	*	*	*	○	○
ATOB	ASCII to BCD	18	*	*	*	○	○
ENCO	Encode	16	–	–	–	–	○
DECO	Decode	16	–	–	–	–	○
TXD1	Transmit 1	21-819	○	○	○	○	○
TXD2	Transmit 2	21-819	–	○	○	○	○
RXD1	Receive 1	21-819	○	○	○	○	○
RXD2	Receive 2	21-819	–	○	○	○	○
LABEL	Label	8	○	○	○	○	○
LJMP	Label Jump	10	○	○	○	○	○
LCAL	Label Call	10	○	○	○	○	○
LRET	Label Return	6	○	○	○	○	○
ROOT	Root	14	*	*	*	○	○
DISP	Display	16	–	–	*	○	○
DGRD	Digital Read	20	–	–	*	○	○
WKTBL	Week Table	13-89	*	*	*	○	○
WKTIM	Week Timer	24	*	*	*	○	○
PULS1	Pulse Output 1	12	–	–	–	○	○
PULS2	Pulse Output 2	12	–	–	–	○	○
PWM1	Pulse Width Modulation 1	24	–	–	–	○	○
PWM2	Pulse Width Modulation 2	24	–	–	–	○	○
RAMP	Ramp Pulse Output	14	–	–	–	○	○
ZRN1	Zero Return 1	18	–	–	–	–	○
ZRN2	Zero Return 2	18	–	–	–	–	○
XYFS	XY Format Set	24-124	–	–	*	○	○
CVXTY	Convert X to Y	18	–	–	*	○	○
CVYTX	Convert Y to X	18	–	–	*	○	○
PID	PID Control	26	–	–	*	○	○
IOREF	I/O Refresh	16	○	○	○	○	○
BCNT	Bit Count	18	–	–	–	–	○
ALT	Alternate Output	10	–	–	–	–	○
DTML	1-sec Dual Timer	22	–	–	–	–	○
DTIM	100-msec Dual Timer	22	–	–	–	–	○
DTMH	10-msec Dual Timer	22	–	–	–	–	○
DTMS	1-msec Dual Timer	22	–	–	–	–	○
TTIM	Teaching Timer	10	–	–	–	–	○
DI	Disable Interrupt	8	–	–	–	–	○
EI	Enable Interrupt	8	–	–	–	–	○

* Not applicable to the previously released FC4A-C10R2B, FC4A-C16R2B, and FC4A-C24R2B.

Dimensions

Dimensions

FC4A-C10R2, FC4A-C16R2

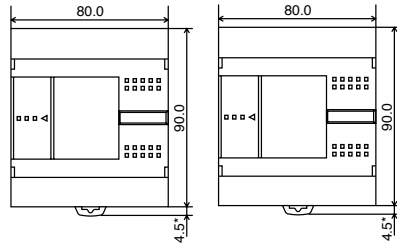

FC4A-C24R2

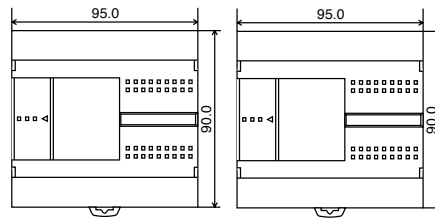

All dimensions in mm

FC4A-D20K3, FC4A-D20S3

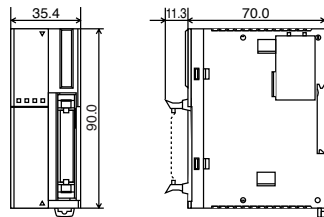

FC4A-D20RK1, FC4A-D20RS1

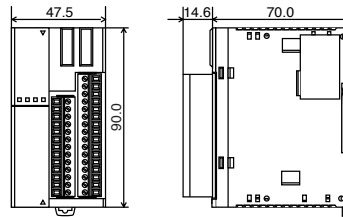

FC4A-D40K3, FC4A-D40S3

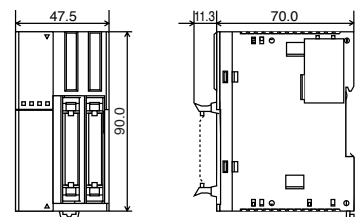

FC4A-N08B1, FC4A-R081,
FC4A-T08K1, FC4A-T08S1,
FC4A-M08BR1, FC4A-L03A1,
FC4A-L03AP1, FC4A-J2A1,
FC4A-K1A1

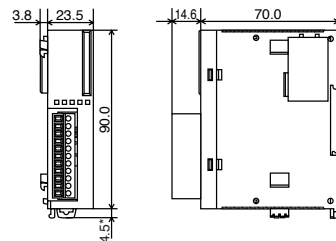

FC4A-N16B3, FC4A-T16K3,
FC4A-T16S3

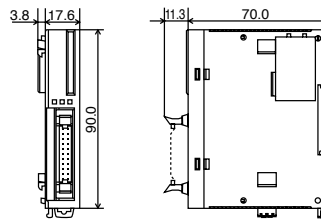

FC4A-HPC1, FC4A-HPC2,
FC4A-HPC3

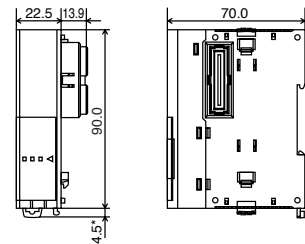

FC4A-N16B1, FC4A-R161

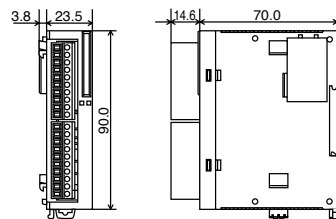

FC4A-N32B3, FC4A-T32K3,
FC4A-T32S3

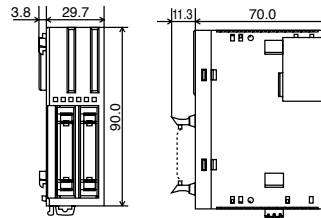

FC4A-HPH1

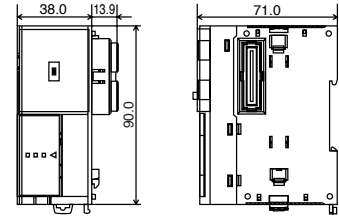

FC4A-M24BR2

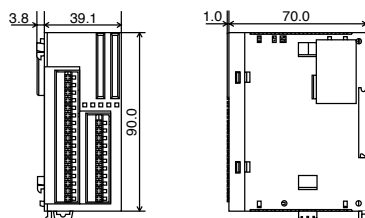

Example

The figure below illustrates a system setup consisting of the all-in-one 24-I/O type CPU module, an 8-point relay output module, and a 16-point DC input module mounted on a 35-mm-wide DIN rail using BNL6P mounting clips.

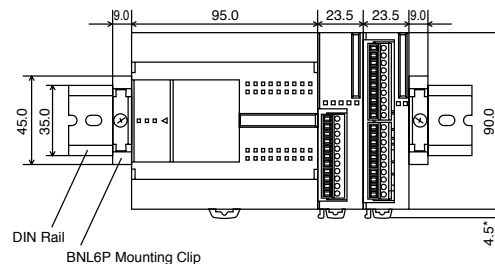

*85mm when the clamp is pulled out

Dimensions

Mounting Hole Layout

FC4A-C10R2, FC4A-C16R2

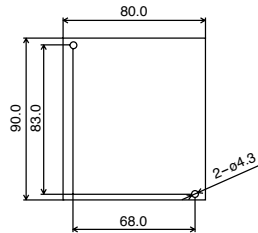

FC4A-C24R2

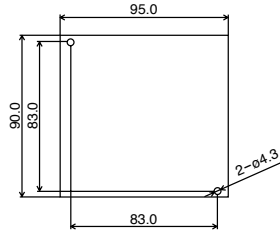

FC4A-D20K3, FC4A-D20S3

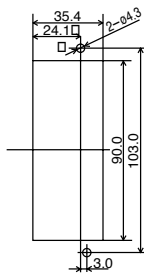

FC4A-D20RK1, FC4A-D20RS1,
FC4A-D40K3, FC4A-D40S3

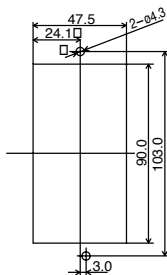

FC4A-N081B1, FC4A-N16B1,
FC4A-R081, FC4A-R161,
FC4A-T08K1, FC4A-T08S1,
FC4A-M08BR1, FC4A-L03A1,
FC4A-L03AP1, FC4A-J2A1,
FC4A-K1A1

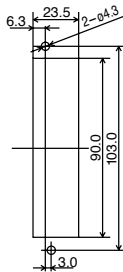

FC4A-N16B3, FC4A-T16K3,
FC4A-T16S3

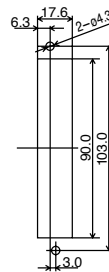

FC4A-N32B3, FC4A-T32K3,
FC4A-T32S3

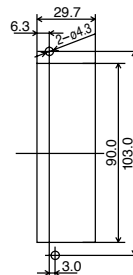

FC4A-M24BR2

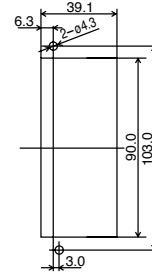

FC4A-HPC1, FC4A-HPC2,
FC4A-HPC3

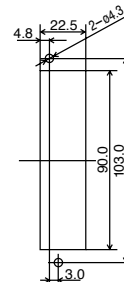

FC4A-HPH1

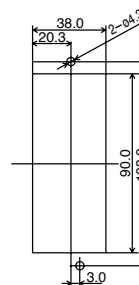

All dimensions in mm

Example

Mounting hole layout for FC4A-C24R2 and 23.5-mm-wide I/O modules

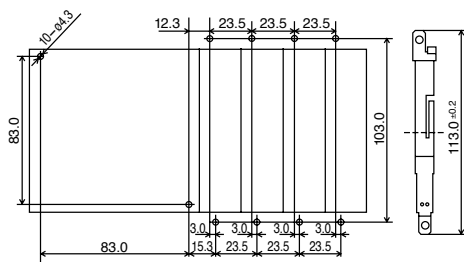

Mounting hole layout for, from left, FC4A-HPH1, FC4A-D20K3, FC4A-N16B3,
FC4A-N32B3, and FC4A-M24R2 modules

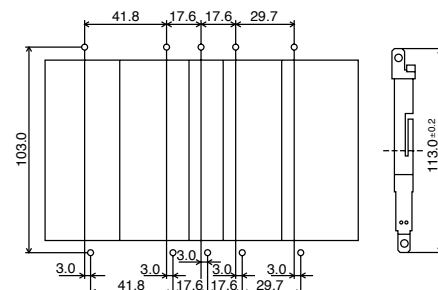

Accessories



Computer Link Cable

3m/9.84 ft. long FC2A-KC4C

O/I Communication Cable

1.52m/5 ft. long FC4A-KC1C



Modem Cable

3m/9.84 ft. long FC2A-KM1C

O/I Communication Cable

1.52m/5 ft. long FC4A-KC2C



User Communication Cable

2.4m/7.87 ft. long FC2A-KP1C



RS232C/RS485 Converter

FC2A-MD1



20-wire shielded I/O Cable

FC9Z-H□□□A20

26-wire shielded I/O Cable

FC9Z-H□□□A26

□□□ Cable length
0.5m/1.64 ft.: 050, 1m/3.28 ft.: 100,
2m/6.56 ft.: 200, 3m/9.84 ft.: 300



20-wire shielded with single connector

1.52m/5 ft. long FC9Z-H100C20A

26-wire shielded with single connector

1.52m/5 ft. long FC9Z-H100C26A

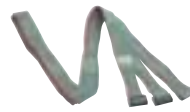

20-wire non-shielded I/O Cable

FC9Z-H□□□B20

26-wire non-shielded I/O Cable

FC9Z-H□□□B26

□□□ Cable length
0.5m/1.64 ft.: 050, 1m/3.28 ft.: 100,
2m/6.56 ft.: 200, 3m/9.84 ft.: 300



20-position Connector Socket

Pkg. qty. 2 FC4A-PMC20P

26-position Connector Socket

Pkg. qty. 2 FC4A-PMC26P



20-point Breakout Modules

For 16 and 32 I/O Expansion Modules
BX1D-S20A



26-point Breakout Modules

For 20 I/O and 40 I/O CPU Modules
BX1D-S26A



13-position Terminal Blocks for slim type CPU modules

Pkg. qty. 2 FC4A-PMT13P



16-position Terminal Blocks for slim type CPU modules

Pkg. qty. 2 FC4A-PMTS16P for FC4A-D20RS1

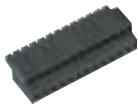

16-position Terminal Blocks for slim type CPU modules

Pkg. qty. 2 FC4A-PMTK16



11-position Terminal Blocks for I/O modules

Pkg. qty. 2 FC4A-PMT11P



10-position Terminal Blocks for I/O modules

Pkg. qty. 2 FC4A-PMT10P



Analog Voltage Input Cables (supplied w/slim type CPU)

Pkg. qty. 2
1m/3.28 ft. FC4A-PMAC2P



Direct Mounting Strips

For direct mounting of slim type CPU or I/O modules on a panel.
Pkg. qty. 5 FC4A-PSP1P



End Clips

BNL6



DIN Rails (1m/3.28 ft. long)

Aluminum
7.5mm height (BAA1000) or
10.5mm height (BNDN1000)



IDECD Screwdrivers

Blue 2.5mm (FC9Z-SD2) or
larger white 3.5mm (FC9Z-SD1)

UNITED STATES**IDEC CORPORATION**

1175 Elko Drive
 Sunnyvale, CA 94089-2209, USA
 Tel (408) 747-0550
 Toll Free (800) 262-IDEC
 Fax (408) 744-9055
 Fax (800) 635-6246
 E-mail: opencontact@idec.com
www.idec.com

IDEC CANADA LIMITED

Unit 22-151 Brunel Road
 Mississauga, Ontario, L4Z 1X3, Canada
 Tel (905) 890-8561
 Toll Free (888) 317-4332
 Fax (905) 890-8562

IDEC AUSTRALIA PTY. LTD.

2/3 Macro Court
 Rowville, Victoria 3178, Australia
 Toll Free 1-800-68-4332
 Fax +61-3-9763-3255
 E-mail: sales@au.idec.com

IDEC IZUMI CORPORATION

7-31, Nishi-Miyahara
 1-Chome, Yodogawa-ku
 Osaka 532-8550, Japan
 Tel +81-6-6398-2571
 Fax +81-6-6392-9731
www.izumi.com

IDEC EUROPEAN HEADQUARTERS

Unit 2 Beechwood
 Chineham Business Park
 Basingstoke
 Hampshire RG24 8WA, United Kingdom
 Tel +44-1256-321000
 Fax +44-1256-327755
 E-mail: idec@uk.idec.com

IDEC ELEKTROTECHNIK GmbH

Wendenstraße 331
 D-20537 Hamburg, Germany
 Tel +49-40-253054-0
 Fax +49-40-25305424
 E-mail: service@idec.de

IDEC IZUMI (H.K.) CO., LTD.

Room No.1409, Tower 1 Silvercord
 30 Canton Road, Tsimshatsui
 Kowloon, Hong Kong
 Tel +852-2-376-2823
 Fax +852-2-376-0790

IDEC IZUMI ASIA PTE. LTD.

No. 31, Tannery Lane #05-01
 Dragon Land Building,
 Singapore 347788
 Tel +65-6746-1155
 Fax +65-6844-5995

IDEC TAIWAN CORPORATION

8F-1, No.79, Hsin Tai Wu Road, Sec. 1
 Hsi-Chih, Taipei County, Taiwan, (ROC)
 Tel +886-4-2301-0809
 Fax +886-4-2301-1110
 E-mail: idec@idec.com

IDEC IZUMI (SHANGHAI) CO., LTD.

Room E, 15F, Majesty Building
 No. 138 Pudong Avenue
 Shanghai 200120, P.R.C.
 Tel +86-21-5887-9181
 Fax +86-21-5887-8930
 E-mail: idec@cn.idec.com

Related IDEC Products

**Switches**

From heavy-duty industrial applications to simple panel controls, IDEC offers several series of switches, pushbuttons, pilot lights and E-stops to meet every need. For more information, visit www.idec.com or see Section A in our Industrial Automation Catalog - U907.

**PS5R - Slim Line Power Supplies**

New in 2003! IDEC is proud to introduce three new power supplies with all features, all the power, and only half the size of traditional power supplies. Save valuable DIN rail space with the 30W, 60W or 90W models while still filling your power needs. For more information, visit www.idec.com or see Section L in our Industrial Automation Catalog - U907.

Specifications and other descriptions in this catalog are subject to change without notice.

**Safety
Precautions**

All MicroSmart modules are manufactured under IDEC's rigorous quality control system, but users must add a backup or failsafe provision to the control system using the MicroSmart in applications where heavy damage or personal injury may be caused in case the MicroSmart should fail.

Turn off the power to the MicroSmart before starting installation, removal, wiring, maintenance, and inspection of the MicroSmart. Failure to turn power off may cause electrical shocks or fire hazard.

Special expertise is required to install, wire, program, and operate the MicroSmart. People without such expertise must not use the MicroSmart.

Read the safety precautions described in the user's manual to make sure of correct operation of the MicroSmart.

www.idec.com

©2003 IDEC Corporation. All Rights Reserved.

Catalog No. EP938-1 06/03 10K